

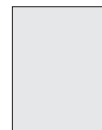

SIJALICE **Si**

MINIJATURNE
HORIZONTALNE
BALON
SA SOČIVOM
CEVASTE
BAJONET
FOCUS
SA UDUBLJENOM OSNOVOM
SA PROIRENOM OSNOVOM
CILINDRIČNE
PILOT
TELEFONSKE
UBODNE
BI-PIN SA NOSAČEM
NEON
DISPLEJ U BOJI
NAVLAKE U BOJI ZA SIJALICE
FASUNG ZA SIJALICE
SIGNALNE SIJALICE
BLIC-STROBOSKOP SIJALICE
TRANSFORMATORI ZA BLIC SIJALICE
HALOGENE
DRZAČI ZA HALOGENE SIJALICE
ZA UREDJAJE BELE TEHNIKE
TEMPERATURNNO OTPORNE
TINJALICE





SIJALICE

SI

MINIJATURNE $\phi 3,2 \times 8$ mm

Tip	U (V)	I (mA)	P(W)
0100	3	100	0,30
0101	6	50	0,30
0102	12	50	0,30

Cena: 0,80

MINIJATURNE $\phi 3,2 \times 8$ mm SA KABLLOM

Tip	U (V)	I (mA)	P(W)
0110	4,5	60	0,27
0111	6	60	0,36
0112	6,3	25	0,16
0113	6,3	40	0,25
0114	6,3	80	0,50
0115	8	40	0,32
0116	8	60	0,46
0117	8	80	0,64
0118	12	40	0,46
0119	12	60	0,72
0120	14	40	0,56
0121	14	80	1,12

Cena: 1,20

MINIJATURNE $\phi 4 \times 10$ mm

Tip	U (V)	I (mA)	P(W)
0201	6	50	0,30
0202	12	50	0,60
0203	24	50	1,20

Cena: 0,80

MINIJATURNE $\phi 4 \times 10$ mm SA KABLLOM

Tip	U (V)	I (mA)	P(W)
0210	4,5	60	0,27
0211	6	60	0,36
0212	6,3	25	0,16
0213	6,3	40	0,25
0214	6,3	80	0,50
0215	8	40	0,32
0216	8	60	0,48
0217	8	80	0,64
0218	12	40	0,48
0219	12	60	0,72
0220	14	40	0,56
0221	14	80	1,12

Cena: 1,40



SIJALICE

SI

MINIJATURNE $\phi 4,7 \times 10$ mm

Tip	U (V)	I (mA)	P(W)
0231	12	50	0,60
0232	24	50	1,20

Cena: 0,80

MINIJATURNE $\phi 5,7 \times 13$ mm

Tip	U (V)	I (mA)	P(W)
0241	4,5	200	0,90
0242	5	115	0,57
0243	6	40	0,24
0244	6	45	0,27
0245	12	40	0,48
0246	14	80	1,12
0247	16	40	0,64
0248	24	50	1,20

Cena: 0,90

HORIZONTALNE $\phi 4 \times 19$ mm

Tip	U (V)	I (mA)	P(W)
0303	3	50	0,15
0306	6	50	0,30
0309	9	50	0,45
0312	12	50	0,60

Cena: 1,00

BALON E 10 $\phi 11 \times 24$ mm

Tip	U (V)	I (mA)	P(W)
1101	1,2	150	0,22
1102	2,5	100	0,25
1103	3,5	200	0,7
1104	4,5	300	1,35
1105	6	50	0,3
1106	6	100	0,6
1107	6	240	1,44
1108	8	50	0,4
1109	12	100	1,2
1110	12	200	2,4
1111	24	50	1,2
1112	24	125	3,0

Cena: 0,80

SA SOČIVOM E 10 $\phi 9,5 \times 23$ mm

Tip	U (V)	I (mA)	P(W)
1201	1,2	200	0,24
1202	2,2	250	0,55
1203	3,7	300	1,11

Cena: 0,80

SA SOČIVOM, BRILIJANT E 10 $\phi 11,5 \times 24$ mm

Tip	U (V)	I (mA)	P(W)
1301	2,2	300	0,66
1302	3,3	300	0,99

Cena: 1,20



SIJALICE

SI

CEVASTE E 5,5 ϕ 4,7 x 15 mm

Tip	U (V)	I (mA)	P(W)
2101	6	50	0,30
2102	6	100	0,60
2103	12	50	0,60
2104	12	100	1,20
2105	24	50	1,20

Cena: 0,80

CEVASTE E 5,5 ϕ 6 x 18 mm

Tip	U (V)	I (mA)	P(W)
2201	3	15	0,05
2202	5	60	0,30
2203	6	40	0,24
2204	6	200	1,20
2205	12	40	0,48
2206	14	80	1,12
2207	18	40	0,72
2208	28	40	1,12

Cena: 1,40

CEVASTE E 10 ϕ 9 x 23 mm

Tip	U (V)	I (mA)	P(W)
2301	6	500	3,0
2302	12	100	1,2
2303	24	125	3,0

Cena: 0,80

CEVASTE E 10 ϕ 10 x 28 mm

Tip	U (V)	I (mA)	P(W)
2401	4	30	0,12
2402	4	100	0,40
2403	6	50	0,30
2404	6	100	0,60
2405	6	150	0,90
2406	6	250	1,50
2407	6	300	1,80
2408	6	500	3,0
2409	7	30	0,21
2410	7	100	0,70
2411	10	200	2,0
2412	12	50	0,60
2413	12	100	1,20
2414	12	250	3,0
2415	14	150	2,10
2416	18	150	2,70
2417	19	100	1,90
2418	24	50	1,20
2419	24	100	2,40
2420	24	125	3,0

Cena: 0,80



SIJALICE

SI

BAJONET BA 7S $\phi 6,6 \times 20$ mm

Tip	U (V)	I (mA)	P(W)
3101	6	50	0,30
3102	6	100	0,60
3103	12	50	0,60
3104	12	100	1,20
3105	24	100	2,40

Cena: 1,40

BAJONET BA 7S $\phi 10 \times 30$ mm

Tip	U (V)	I (mA)	P(W)
3201	6	250	1,50
3202	6	300	1,80

Cena: 0,90

BAJONET BA 9S $\phi 10 \times 28$ mm

Tip	U (V)	I (mA)	P(W)
3301	2,5	500	1,25
3302	6,3	150	0,95
3303	6,3	250	1,57
3304	14	80	1,12
3305	24	50	1,20
3306	28	40	1,12
3307	38	50	1,90
3308	55	50	2,75

Cena: 0,90

BAJONET, BALON BA 9S $\phi 11 \times 24$ mm

Tip	U (V)	I (mA)	P(W)
3401	6	40	0,24
3402	7	100	0,70
3403	12	100	1,20

Cena: 0,80

FOCUS P 13,5S $\phi 11,5 \times 30$ mm

Tip	U (V)	I (mA)	P(W)
3501	2,4	500	1,20
3502	3,6	500	1,80
3503	4,8	500	2,40
3504	6	500	3,0

Cena: 0,80

SA UDUBLJENOM OSNOVOM $\phi 6 \times 18$ mm

Tip	U (V)	I (mA)	P(W)
4101	5	60	0,30
4102	6,3	40	0,25
4103	6,3	200	1,26
4104	12	40	0,48
4105	14	300	4,20
4106	18	40	0,72
4107	28	40	1,12

Cena: 1,60



SIJALICE

SI

SA PROŠIRENOM OSNOVOM $\phi 6 \times 15 \text{ mm}$

Tip	U (V)	I (mA)	P(W)
4201	3	35	0,10
4202	5	60	0,30
4203	6	40	0,24
4204	6	200	1,20
4205	6,3	40	0,25
4206	6,3	200	1,26
4207	12	40	0,48
4208	14	80	1,12
4209	18	40	0,72
4210	28	40	1,12
4211	48	25	1,20

Cena: 1,50

CILINDRIČNE $\phi 6 \times 36 \text{ mm}$

Tip	U (V)	I (mA)	P(W)
5101	6	500	3,0
5102	12	250	3,0
5103	18	100	1,80

Cena: 1,20

CILINDRIČNE $\phi 7,7 \times 30 \text{ mm}$

Tip	U (V)	I (mA)	P(W)
5201	6	50	0,30
5202	12	250	3,0
5203	24	125	3,0

Cena: 1,20

CILINDRIČNE $\phi 8,5 \times 37 \text{ mm}$

Tip	U (V)	I (mA)	P(W)
5301	6	83	0,50
5302	24	21	0,50

Cena: 1,20

CILINDRIČNE $\phi 10,5 \times 37 \text{ mm}$

Tip	U (V)	I (mA)	P(W)
5401	12	42	0,50

Cena: 1,20

PILOT $\phi 6,3 \times 31 \text{ mm}$

Tip	U (V)	I (mA)	P(W)
6101	6	150	0,90
6102	6	250	1,50
6103	6	300	1,80
6104	8	150	1,20
6105	8	250	2,0
6106	8	300	2,40
6107	9	220	2,0
6108	12	150	1,80
6109	12	250	3,0

Cena: 1,20



SIJALICE

SI

TELEFONSKE T 5,5 ϕ 4,8 x 30 mm

Tip	U (V)	I (mA)	P(W)
7101	6	200	1,20
7102	12	100	1,20
7103	24	50	1,20
7104	30	40	1,20

Cena: 2,50

TELEFONSKE T 6,8F ϕ 5,9 x 44 mm

Tip	U (V)	I (mA)	P(W)
7201	6	200	1,20
7202	12	100	1,20
7203	24	50	1,20
7204	30	40	1,20

Cena: 2,50

UBODNE ϕ 5 x 20 mm

Tip	U (V)	I (mA)	P(W)
7301	6	30	0,18
7302	6	80	0,48
7303	6	200	1,20
7304	12	30	0,36
7305	12	80	0,96
7306	12	100	1,20
7307	14	80	1,12
7308	24	30	0,72
7309	28	40	1,12

Cena: 1,50

UBODNE ϕ 10 x 26,8 mm

Tip	U (V)	I (mA)	P(W)
7401	12/15	150	2,0
7402	12	250	3,0

Cena: 1,80

BI-PIN SA NOSAČEM ϕ 6 x 15 mm

Tip	U (V)	I (mA)	P(W)
7501	3	15	0,05
7502	5	60	0,30
7503	6,3	40	0,25
7504	6,3	200	1,26
7505	12	40	0,48
7506	14	80	1,12
7507	18	40	0,72
7508	28	40	1,12

Cena: 1,80

NEON ϕ 6 x 18 mm (ZA SIGNALNE SIJALICE)

Tip	U _A (V AC)	U _A (V DC)	I _N (mA)	R (k Ω)	R (W)
N6506	60	90	0,6	180/220	0,25

Cena: 0,50



SIJALICE

SI

DISPLEJ U BOJI

Tip	U (V)	I (mA)	P(W)	Boja
8100	3	90	0,27	plava
8101	3	90	0,27	zelena
8102	3	90	0,27	crvena
8103	3	90	0,27	(uta
8104	8	70	0,56	plava
8105	8	70	0,56	zelena
8106	8	70	0,56	crvena
8107	8	70	0,56	(uta
8108	12	65	0,78	plava
8109	12	65	0,78	zelena
8110	12	65	0,78	crvena
8111	12	65	0,78	(uta



Cena: 1,00

NAVLAKE U BOJI ZA SIJALICE

Tip	Boja
NA-CR	crvena
NA-PL	plava
NA-NA	narand(asta
NA-ZE	zelena



Cena: 0,12

FASUNG ZA SIJALICE

	F-E5,5S	0,50		F-E10	0,50		F-E10S	0,70		F-BA9	0,80		F-BA9S	0,80
---	---------	------	---	-------	------	---	--------	------	--	-------	------	---	--------	------

SIGNALNE SIJALICE

PRAVOUGAONE			OKRUGLE		
Tip	Boja	U (V)	Tip	Boja	U (V)
SIS-PCR	crvena	220	SIS-OCR	crvena	220
SIS-PZE	zelena	220	SIS-OZE	zelena	220
SIS-PHA	oran(220	SIS-ONA	oran(220
SIS-PBE	bela	220			



Cena: 3,50

Cena: 3,00



SIJALICE

SI

KUČIŠTA ZA SIGNALNE SIJALICE

Tip	Boja	
SIS-KCR	crvena	
SIS-KZE	zelena	
SIS-KNA	oran(Cena: 1,20



BLIC – STROBOSKOP SIJALICE

Tehnički podaci

Tip	U_{nenn} (V)	$U_{min.}$ (V)	E (Ws)	Z	L	U_T (kV)	E_T (mW)
BL-LB4050	360	220	60	6	3000	4	0,6
BL-LB3745	360	220	45	6	3000	4	0,6
BL-LB3728	360	220	20	6	3000	4	0,6

U_{nenn} = radni napon, $U_{min.}$ = minimalni napon, E= energija po bljesku, Z= bljesak / min. (max.), L= vek trajanja, U_T - napon okidanja, E_T - snaga primara okidnog transformatora

Dimenzije u mm

Tip	A	l	e	a	d
BL-LB4050	54	50	35	2	4,0
BL-LB3745	49	45	30	2	3,7
BL-LB3728	34	28,5	15	2,75	3,7

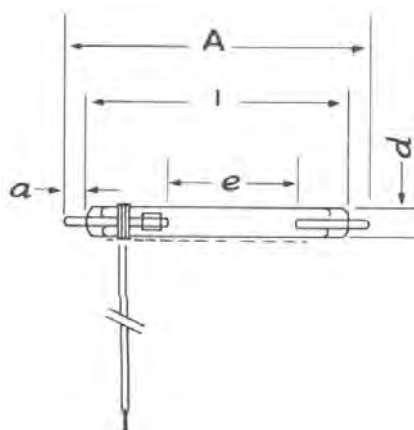

BL-LB4050



Cena: 7,00

BL-LB3745



Cena: 7,00

BL-LB3728



Cena: 8,00



SIJALICE

SI

BLIC – STROBOSKOP SIJALICE

Tehnički podaci

Tip	U_{nenn} (V)	$U_{min.}$ (V)	U_S (V)	E (Ws)	Z	L	U_T (kV)	E_T (mW)
BL-UB1	300	200	400	60	6	1×10^4	6	0,8
BL-UB1221	300	200	400	4	60	1×10^6	4	0,6
BL-UB6531	300	250	400	60	6	1×10^4	6	0,8
BL-UB0661	350	270	500	8	60	2×10^6	4	0,6
BL-FT 218	450	350	500	250	4	1×10^4	6	0,8

U_{nenn} = radni napon, $U_{min.}$ = minimalni napon, U_S = vršni napon, E = energija po bljesku, Z = bljesak / min. (max.), L = vek trajanja, U_T = napon okidanja, E_T = snaga primara okidnog transformatora

Dimenzije u mm

Tip	e	d	a	c
BL-UB1	32	6	16	15
BL-UB1221	29	6	19	40
BL-UB6531	38	6	13,5	40
BL-UB0661	40	6	13,5	40
BL-FT 218	55	8	25	40

Blic sijalica

Transformator

BL-UB1	SIBT200
BL-UB1221	SIBT200
BL-UB6531	SIBT200 (4 kV) ili SIBT32 (6 kV)
BL-UB0661	SIBT32
BL-FT 218	SIBT32

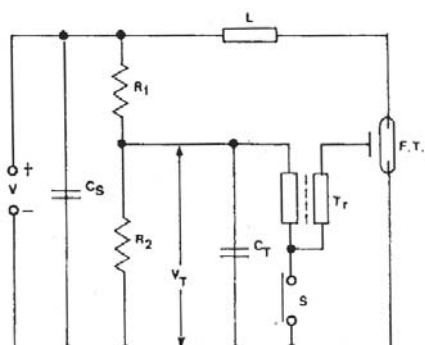

BL-UB1

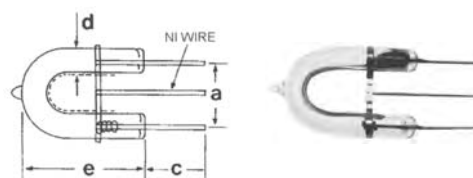

Cena: 9,00

BL-UB1221

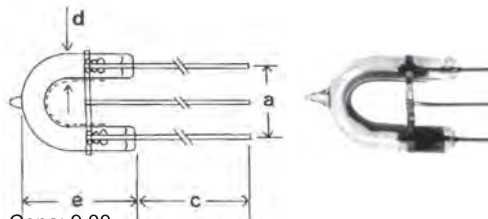

Cena: 9,00

BL-UB6531

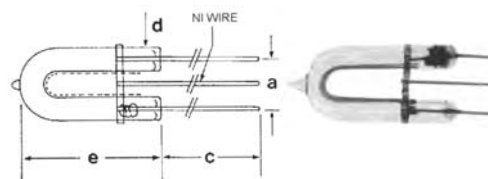

Cena: 9,00

BL-UB0661

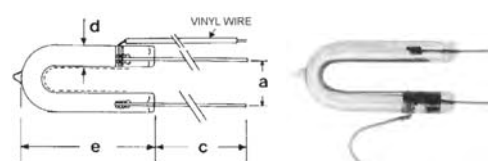

Cena: 12,00

BL-FT218

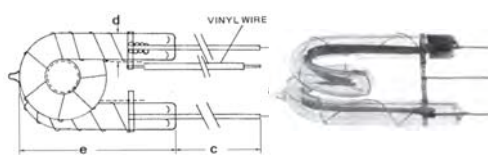

Cena: 24,00



SIJALICE

SI

TRANSFORMATORI ZA BLIC – STROBOSKOP SIJALICE

Tehnički podaci

Tip	U _{prim.} (V)	U _{sek.} (V)	W _{prim.}	W _{sek.}	I _{prim.} (μH)	I _{sek.} (mH)
BT200	170	4	10	500	2,5	3
BT32	190	6	19	1000	6,5	13
BT50	300	10	10	1000	3,5	21
BT75	300	15	17	1350	9,0	37

U= napon, W= broj namotaja, I= induktivnost

Tip	R _{prim.} (mW)	R _{sek.} (W)	K (μF)	P _I (mJ)
BT200	80	70	0,04	0,6
BT32	130	180	0,05	0,9
BT50	130	180	0,22	10,0
BT75	150	150	0,22	10,0

R= unutrašnja otpornost, K= kapacitivnost okidnog kondenzatora, P_I = snaga impulsa

BT200

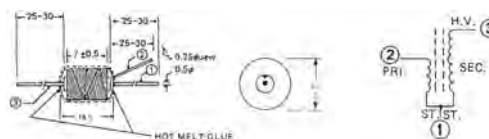

Cena: 3,00

BT32

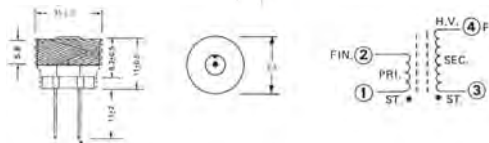

Cena: 4,00

BT50

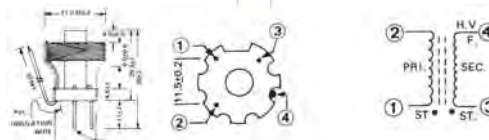

Cena: 8,00

BT75

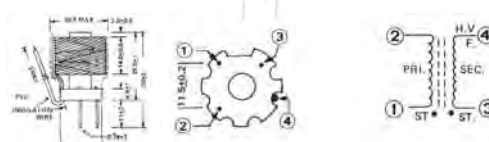

Cena: 9,00



SIJALICE

SI

HALOGENE 8,5 x 31 mm G 4

Tip	U (V)	P (W)	Nosač
H1205	12	5	HD01
H1210	12	10	HD01
H1220	12	20	HD01

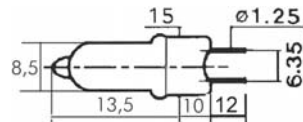

Cena: 2,80

HALOGENE 10 x 38 mm GY 6,35

Tip	U (V)	P (W)	Nosač
H1235	12	35	HD02
H1250	12	50	HD02
H1275	12	75	HD02

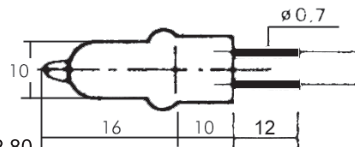

Cena: 2,80

HALOGENE SA REFLEKTOROM

Tip	U (V)	I (A)	P (W)	Nosač
H20	12	100	20	HD03
H35	12	300	35	HD03
H50	12	500	50	HD03

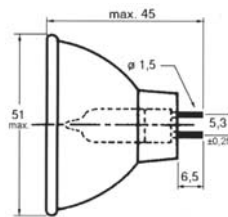

Cena: 6,00

HALOGENE, ŠTAP

Tip	U (V)	P (W)	L (mm)
HS100	220	100	78
HS150	220	150	78
HS200	220	200	118
HS300	220	300	118
HS500	220	500	118

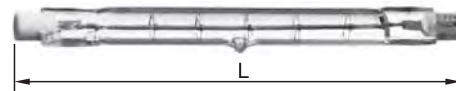

Cena: 6,00

DR(AČI ZA HALOGENE SIJALICE

<p>HD01 2,00</p>	<p>HD02 2,00</p>	<p>HD03 2,00</p>
-------------------------	-------------------------	-------------------------



SIJALICE

SI

SIJALICE ZA UREDJAJE BELE TEHNIKE SI-BT

<table border="1"> <thead> <tr> <th>Tip</th> <th>U (v)</th> <th>P (w)</th> <th>Baza</th> <th>Cena</th> </tr> </thead> <tbody> <tr> <td>150</td> <td>220</td> <td>15</td> <td>B15</td> <td>1,50</td> </tr> </tbody> </table>	Tip	U (v)	P (w)	Baza	Cena	150	220	15	B15	1,50	
Tip	U (v)	P (w)	Baza	Cena							
150	220	15	B15	1,50							
<table border="1"> <thead> <tr> <th>Tip</th> <th>U (v)</th> <th>P (w)</th> <th>Baza</th> <th>Cena</th> </tr> </thead> <tbody> <tr> <td>151</td> <td>240</td> <td>15</td> <td>E14</td> <td>1,50</td> </tr> </tbody> </table>	Tip	U (v)	P (w)	Baza	Cena	151	240	15	E14	1,50	
Tip	U (v)	P (w)	Baza	Cena							
151	240	15	E14	1,50							
<table border="1"> <thead> <tr> <th>Tip</th> <th>U (v)</th> <th>P (w)</th> <th>Baza</th> <th>Cena</th> </tr> </thead> <tbody> <tr> <td>153</td> <td>240</td> <td>15</td> <td>B22</td> <td>5,00</td> </tr> </tbody> </table>	Tip	U (v)	P (w)	Baza	Cena	153	240	15	B22	5,00	
Tip	U (v)	P (w)	Baza	Cena							
153	240	15	B22	5,00							
<table border="1"> <thead> <tr> <th>Tip</th> <th>U (v)</th> <th>P (w)</th> <th>Baza</th> <th>Cena</th> </tr> </thead> <tbody> <tr> <td>154</td> <td>240</td> <td>15</td> <td>E17</td> <td>4,00</td> </tr> </tbody> </table>	Tip	U (v)	P (w)	Baza	Cena	154	240	15	E17	4,00	
Tip	U (v)	P (w)	Baza	Cena							
154	240	15	E17	4,00							
<table border="1"> <thead> <tr> <th>Tip</th> <th>U (v)</th> <th>P (w)</th> <th>Baza</th> <th>Cena</th> </tr> </thead> <tbody> <tr> <td>202</td> <td>240</td> <td>20</td> <td>E17</td> <td>4,00</td> </tr> </tbody> </table>	Tip	U (v)	P (w)	Baza	Cena	202	240	20	E17	4,00	
Tip	U (v)	P (w)	Baza	Cena							
202	240	20	E17	4,00							
<table border="1"> <thead> <tr> <th>Tip</th> <th>U (v)</th> <th>P (w)</th> <th>Baza</th> <th>Cena</th> </tr> </thead> <tbody> <tr> <td>203</td> <td>240</td> <td>20</td> <td>2 x 4,8</td> <td>8,00</td> </tr> </tbody> </table>	Tip	U (v)	P (w)	Baza	Cena	203	240	20	2 x 4,8	8,00	
Tip	U (v)	P (w)	Baza	Cena							
203	240	20	2 x 4,8	8,00							
<table border="1"> <thead> <tr> <th>Tip</th> <th>U (v)</th> <th>P (w)</th> <th>Baza</th> <th>Cena</th> </tr> </thead> <tbody> <tr> <td>251</td> <td>240</td> <td>25</td> <td>E14</td> <td>1,50</td> </tr> </tbody> </table>	Tip	U (v)	P (w)	Baza	Cena	251	240	25	E14	1,50	
Tip	U (v)	P (w)	Baza	Cena							
251	240	25	E14	1,50							



SIJALICE

SI

SIJALICE ZA UREDJAJE BELE TEHNIKE SI-BT

<table border="1"> <thead> <tr> <th>Tip</th> <th>U (v)</th> <th>P (w)</th> <th>Baza</th> <th>Cena</th> </tr> </thead> <tbody> <tr> <td>252</td> <td>240</td> <td>25</td> <td>BA15</td> <td>2,50</td> </tr> </tbody> </table>	Tip	U (v)	P (w)	Baza	Cena	252	240	25	BA15	2,50	
Tip	U (v)	P (w)	Baza	Cena							
252	240	25	BA15	2,50							
<table border="1"> <thead> <tr> <th>Tip</th> <th>U (v)</th> <th>P (w)</th> <th>Baza</th> <th>Cena</th> </tr> </thead> <tbody> <tr> <td>253</td> <td>240</td> <td>25</td> <td>B22</td> <td>6,00</td> </tr> </tbody> </table>	Tip	U (v)	P (w)	Baza	Cena	253	240	25	B22	6,00	
Tip	U (v)	P (w)	Baza	Cena							
253	240	25	B22	6,00							
<table border="1"> <thead> <tr> <th>Tip</th> <th>U (v)</th> <th>P (w)</th> <th>Baza</th> <th>Cena</th> </tr> </thead> <tbody> <tr> <td>254</td> <td>240</td> <td>25</td> <td>E14</td> <td>1,50</td> </tr> </tbody> </table>	Tip	U (v)	P (w)	Baza	Cena	254	240	25	E14	1,50	
Tip	U (v)	P (w)	Baza	Cena							
254	240	25	E14	1,50							
<table border="1"> <thead> <tr> <th>Tip</th> <th>U (v)</th> <th>P (w)</th> <th>Baza</th> <th>Cena</th> </tr> </thead> <tbody> <tr> <td>256</td> <td>240</td> <td>25</td> <td>E17</td> <td>4,00</td> </tr> </tbody> </table>	Tip	U (v)	P (w)	Baza	Cena	256	240	25	E17	4,00	
Tip	U (v)	P (w)	Baza	Cena							
256	240	25	E17	4,00							
<table border="1"> <thead> <tr> <th>Tip</th> <th>U (v)</th> <th>P (w)</th> <th>Baza</th> <th>Cena</th> </tr> </thead> <tbody> <tr> <td>257</td> <td>125</td> <td>25</td> <td>E17</td> <td>4,00</td> </tr> </tbody> </table>	Tip	U (v)	P (w)	Baza	Cena	257	125	25	E17	4,00	
Tip	U (v)	P (w)	Baza	Cena							
257	125	25	E17	4,00							
<table border="1"> <thead> <tr> <th>Tip</th> <th>U (v)</th> <th>P (w)</th> <th>Baza</th> <th>Cena</th> </tr> </thead> <tbody> <tr> <td>401</td> <td>240</td> <td>40</td> <td>E14</td> <td>2,00</td> </tr> </tbody> </table>	Tip	U (v)	P (w)	Baza	Cena	401	240	40	E14	2,00	
Tip	U (v)	P (w)	Baza	Cena							
401	240	40	E14	2,00							
<table border="1"> <thead> <tr> <th>Tip</th> <th>U (v)</th> <th>P (w)</th> <th>Baza</th> <th>Cena</th> </tr> </thead> <tbody> <tr> <td>825</td> <td>240</td> <td>20</td> <td>2 x 4,3</td> <td>8,00</td> </tr> </tbody> </table>	Tip	U (v)	P (w)	Baza	Cena	825	240	20	2 x 4,3	8,00	
Tip	U (v)	P (w)	Baza	Cena							
825	240	20	2 x 4,3	8,00							



SIJALICE

SI

TEMPERATURNO OTPORNE SIJALICE SI-TO

<table border="1"> <thead> <tr> <th>Tip</th> <th>U (v)</th> <th>P (w)</th> <th>Baza</th> <th>T°C</th> <th>Cena</th> </tr> </thead> <tbody> <tr> <td>50</td> <td>220</td> <td>15</td> <td>E14</td> <td>300</td> <td>2,50</td> </tr> </tbody> </table>	Tip	U (v)	P (w)	Baza	T°C	Cena	50	220	15	E14	300	2,50	
Tip	U (v)	P (w)	Baza	T°C	Cena								
50	220	15	E14	300	2,50								
<table border="1"> <thead> <tr> <th>Tip</th> <th>U (v)</th> <th>P (w)</th> <th>Baza</th> <th>T°C</th> <th>Cena</th> </tr> </thead> <tbody> <tr> <td>51</td> <td>220</td> <td>25</td> <td>E27</td> <td>300</td> <td>2,50</td> </tr> </tbody> </table>	Tip	U (v)	P (w)	Baza	T°C	Cena	51	220	25	E27	300	2,50	
Tip	U (v)	P (w)	Baza	T°C	Cena								
51	220	25	E27	300	2,50								
<table border="1"> <thead> <tr> <th>Tip</th> <th>U (v)</th> <th>P (w)</th> <th>Baza</th> <th>T°C</th> <th>Cena</th> </tr> </thead> <tbody> <tr> <td>52</td> <td>220</td> <td>40</td> <td>E27</td> <td>300</td> <td>2,50</td> </tr> </tbody> </table>	Tip	U (v)	P (w)	Baza	T°C	Cena	52	220	40	E27	300	2,50	
Tip	U (v)	P (w)	Baza	T°C	Cena								
52	220	40	E27	300	2,50								
<table border="1"> <thead> <tr> <th>Tip</th> <th>U (v)</th> <th>P (w)</th> <th>Baza</th> <th>T°C</th> <th>Cena</th> </tr> </thead> <tbody> <tr> <td>54</td> <td>220</td> <td>40</td> <td>E14</td> <td>300</td> <td>2,00</td> </tr> </tbody> </table>	Tip	U (v)	P (w)	Baza	T°C	Cena	54	220	40	E14	300	2,00	
Tip	U (v)	P (w)	Baza	T°C	Cena								
54	220	40	E14	300	2,00								

TINJALICE. SI-TI

<table border="1"> <thead> <tr> <th>Tip</th> <th>U (v)</th> <th>Baza</th> <th>Cena</th> </tr> </thead> <tbody> <tr> <td>BA</td> <td>220</td> <td>BA9</td> <td>2,00</td> </tr> </tbody> </table>	Tip	U (v)	Baza	Cena	BA	220	BA9	2,00	
Tip	U (v)	Baza	Cena						
BA	220	BA9	2,00						
<table border="1"> <thead> <tr> <th>Tip</th> <th>U (v)</th> <th>Baza</th> <th>Cena</th> </tr> </thead> <tbody> <tr> <td>E10</td> <td>220</td> <td>E10</td> <td>2,00</td> </tr> </tbody> </table>	Tip	U (v)	Baza	Cena	E10	220	E10	2,00	
Tip	U (v)	Baza	Cena						
E10	220	E10	2,00						
<table border="1"> <thead> <tr> <th>Tip</th> <th>U (v)</th> <th>Baza</th> <th>Cena</th> </tr> </thead> <tbody> <tr> <td>E14</td> <td>220</td> <td>E14</td> <td>2,50</td> </tr> </tbody> </table>	Tip	U (v)	Baza	Cena	E14	220	E14	2,50	
Tip	U (v)	Baza	Cena						
E14	220	E14	2,50						

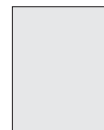



SIJALICE

SI

E5,5

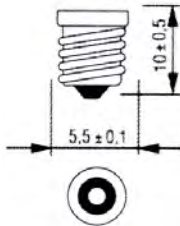

E10

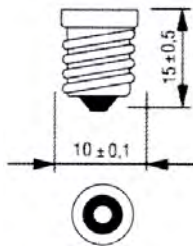

E14

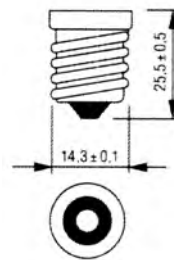

E27

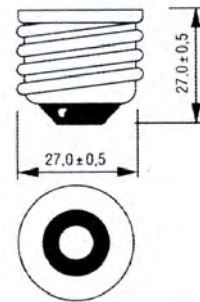

BA7S

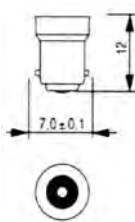

BA9S

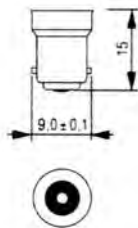

BA15

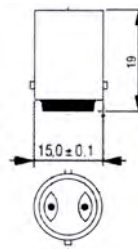

B15D

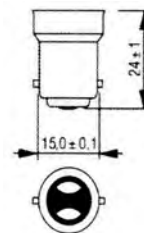

B22-2

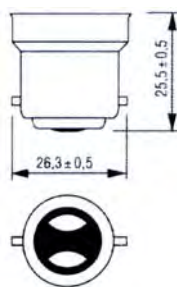

B22-3

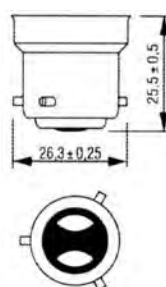

P13,5S

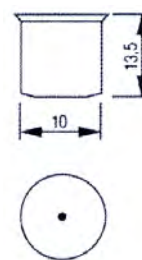

S15

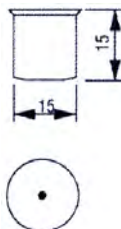

S15S

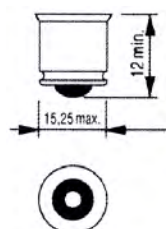

S19S

