

Frigidaire



Parts and Accessories Catalog



Refrigeration Accessories and Parts

| | |
|--------------------|-------------|
| Accessories | 4-8 |
| Parts | 9-14 |

Range Accessories and Parts

| | |
|--------------------|--------------|
| Accessories | 16-18 |
| Parts | 19-27 |

Dishwasher and Laundry Accessories and Parts

| | |
|--------------------|--------------|
| Accessories | 29-31 |
| Parts | 32-35 |

Outdoor Kitchens Accessories

| | |
|--------------------|--------------|
| Accessories | 37-42 |
|--------------------|--------------|

Home Comfort Accessories

| | |
|--------------------|--------------|
| Accessories | 44-45 |
|--------------------|--------------|

Service Company Accessories

| | |
|--------------------|--------------|
| Accessories | 47-48 |
|--------------------|--------------|

Cleaners

| | |
|--------------------|--------------|
| Accessories | 50-52 |
|--------------------|--------------|

Refrigeration Accessories and Parts

Accessories

Retail Packaged Parts
Shelves
Water Filters
Miscellaneous

Parts

Add-on Condenser Kits
Compressors
Defrost Thermostats
Defrost Timers
Door Gaskets
Door Support
Hinge Assembly
Icemakers
Motors
Water Valves



Miscellaneous



Fridge Aid Deodorizer

Prevent distasteful odors from taking over your refrigerator or freezer with our universal refrigerator/freezer deodorizer. Easy to use, simply place in the area you wish to deodorize and let it do the rest!

- Lasts up to 1 year
- For use with all refrigerators and freezers

P/N 78956



Frigidaire Ice Tray

Made to last a lifetime, these ice trays are made of a high-quality polypropylene that returns to its shape even after considerable bending.

- Special design allows extremely stable stacking
- Dishwasher safe

P/N 01121808



Butter Dish

Perfect for storing and serving butter with your favorite meal.

P/N 5308000716

Also Available:

Part #

| | |
|---------------------------------|-------------|
| Egg Tray | 215817806 |
| 40 Watt Appliance Light Bulb | S5305514148 |
| Freezer Key | 216702900 |
| Glide n' Guard Floor Protectors | 93001 |

Retail Packaged Parts



10" Water Filter

- Replaces most in-line filters
- Filter provides better taste, odor, and color
- Easily installed, saves you money
- For use in all in-line water filter applications

P/N S5305510266



20' Copper Waterline Intstall Kit (Self Tapping)

All copper construction with no plastic parts to crack or leak. Easily installed with common tools, no cutting or soldering required.

- Instructions included
- Universal

P/N S5305510264

Shelves



VersaShelf

Put the unused space below your refrigerator's shelves to work. Use our convenient Versa Shelf to chill soda cans, a 2-liter bottle of soda, a loaf of bread, or other small items. Rack hooks onto the shelf for easy removal for cleaning.

- Available in White or Clear
- Size: 16.01" long
- Universal fit on any cantilevered shelf

P/N 240424501 (White)

P/N 240424502 (Clear)

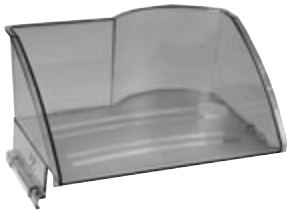

Ice Cream Holder

No room on the shelf for the ice cream box? We have the solution for you. Our ice cream shelf utilizes the unused space above the ice maker (in some models)! Ice cream stays colder because of better air circulation around the box.

- Available in clear
- Size: 10.11" wide

P/N 240342902



Wine Rack

Chill that special bottle of wine with our handy wine rack. Fits adjustable shelves by hooking onto the shelf.

- Available in White or Clear
- Size: 11.94" long

P/N 5304402116 (White)

P/N 5303295947 (Clear)

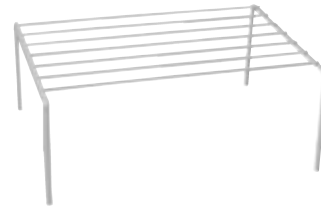

Universal Freestanding Freezer Shelf

Help organize your freezer with this universal freestanding freezer shelf.

- Made out of durable metal covered in enamel
- Available in white
- 4.5" x 8.5" W x 11.5" D

P/N ISK17 (subs ISK18)

P/N ISK21

WaterFilters

Proprietary



Pure Source™ (WFCB)

WFCB- This replacement water filter has been strenuously tested and certified by NSF International. It protects your family by reducing all of the following contaminants:

- Cysts by 99.99%
- Particulates (class 1) by 99.80%
- Turbidity by 99.70%
- Lead by 99.30%
- Chlorine (class 1) by 97.80%
- 2,4-D a common herbicide, by 94.20%, and Atrazine by 94.90%
- Toxaphene, a common pesticide by 87.50%

Fits all Frigidaire filter-equipped refrigerator models manufactured before 2001 energy compliant regulations.

P/N WFCB



PureSource Plus™ (WF1CB)

This replacement filter has been strenuously tested and certified by NSF International (the internationally recognized authority on water quality). The filtration system is built into the inside of the refrigerator for replacement ease and convenience. It also reduces:

- Particulates (class III) by more than 98%
- Chlorine (class I) by more than 96%

Designed exclusively for the following models: FRS23KR4A FRS23R3A FRS26R3A FRS23R4A FRS26KR4A FRS26R4A MRSR25V4A MRSR25X8A MRSR25V5A MRSZ28X8A

P/N WF1CB

WaterFilters

Proprietary



PureSource2™ (WF2CB)

This replacement filter has been strenuously tested and certified by NSF International (the internationally recognized authority on water quality). The PureSource2™ filtration system is built into the inside of your refrigerator for replacement ease and convenience. Its advanced engineering reduces:

- Cysts by 99.99%
- Particulates (class 1) by 98.5%
- Turbidity by 99.70%
- Lead by 99.30%
- Particulates (class III) by more than 98.6%
- Mercury by 91%
- Herbicides 1,4-D by 96%, Alachlor by 98%, and Atrazine by 98%
- Pesticides Lindane by 92% and Toxaphene by 87.5%
- Fits all front cassette models

P/N WF2CB

Universal



Universal "In-Line" Waterfilter

Our inline filters provides better taste, odor, and clarity.

- Fits most major manufacturer brands

P/N 5303917645

Freezer Baskets

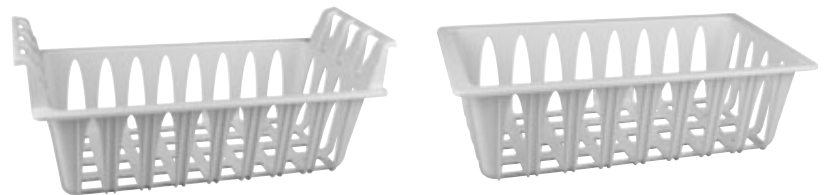

Now you can organize your chest freezer with this durable storage basket. Storage convenience at your fingertips.

Part #

| | |
|------------------------------|-----------|
| Upper, White, Freezer Basket | 216916200 |
| Lower, White, Freezer Basket | 216867400 |
| Upper, Blue, Freezer Basket | 216916201 |
| Lower, Blue, Freezer Basket | 216867401 |

Condenser Kit

| Item # | Description | Part # |
|-----------|------------------------------------|-------------|
| 1 | 5 cu ft chest | 5300120779 |
| Not Shown | 7-8 cu ft. chest | 5300120780 |
| Not Shown | 10 cu upright | 5303304537 |
| Not Shown | 13 to 16 cu ft chest | 5 303925238 |
| Not Shown | 13 to 16 cu ft upright | 5300123788 |
| Not Shown | 18 to 20 cu ft chest | 5303280307 |
| Not Shown | 19 to 21 cu ft upright (Artic Air) | 5300083897 |
| Not Shown | 23 to 26 cu ft chest | 5300300173 |

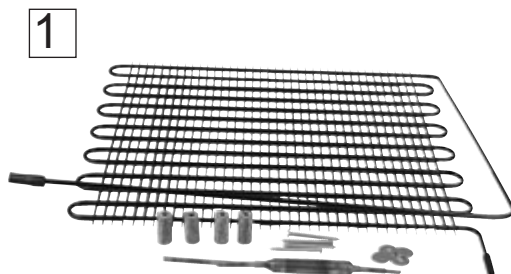

Compressors

All Kits Include: Electrical components, terminals, and drier filter



Compressor R12

| Item # | Description | Part # |
|-----------|---|------------|
| 1 | 115v Compressor | 5304428316 |
| Not Shown | 115v Compressor | 5304428318 |
| Not Shown | 115V 400 BTU 1/4" & 5/16" Sleeves & Pan Kit | 5300186041 |
| Not Shown | 115V 735 BTU 1/4" & 5/16" Sleeves & Pan Kit | 5304428314 |
| Not Shown | 115V 915 BTU 1/4" & 5/16" Sleeves & Pan Kit & Condenser Kit | 5304428317 |
| Not Shown | 115V 915 BTU 1/4" & 5/16" Sleeves & Pan Kit | 5304428319 |
| Not Shown | 115V 1350 BTU 1/4" & 5/16" Sleeves | 5304428315 |
| Not Shown | 220V 1150 BTU 1/4" & 5/16" Sleeves & Pan Kit | 5304428322 |
| Not Shown | 220V 915 BTU 1/4" & 5/16" Sleeves & Pan Kit | 5304428321 |

Compressor Kit Components

| Item # | Description | Part # |
|--------|--------------------------|------------|
| 1 | Sleeve, (1/4" O.D.) | G103457 |
| 2 | Sleeve, (5/16" O.D.) | G154294 |
| 3 | Condenser Kit | 5303925485 |
| 4 | Electrical Parts Kit | 216868102 |
| 5 | Pan Kit | 5304428401 |
| 6 | Filter Drier (Universal) | 5303305677 |

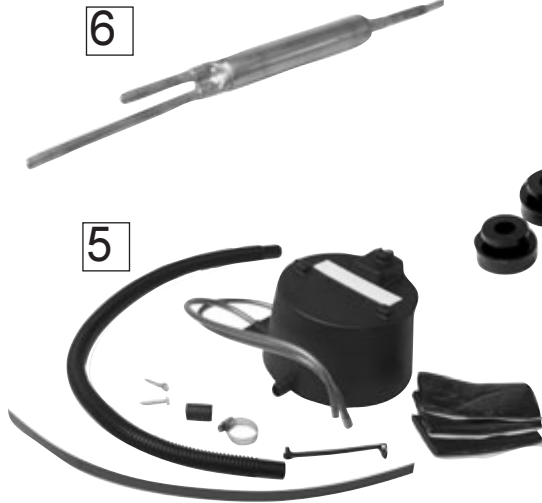
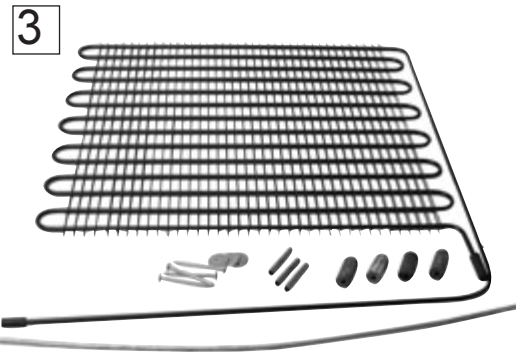
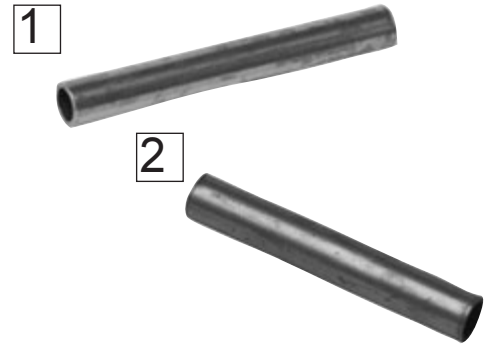

Defrost Thermostats

| Item # | Description | Part # |
|-----------|-----------------------------------|------------|
| 1 | Defrost Thermostat w/Bracket L-45 | 5304413855 |
| 2 | Defrost Thermostat (Electrical) | 5303200810 |
| 3 | Thermostat, Temperature Control | 5300122557 |
| 4 | Thermostat, Defrost Kit L55-20F | 5303917954 |
| Not Shown | Defrost Thermostat w/Bracket L-50 | 5303917628 |
| Not Shown | Defrost Thermostat w/Bracket L-55 | 5303917629 |
| Not Shown | Defrost Thermostat w/Bracket L-60 | 5303917630 |
| Not Shown | Defrost Thermostat w/Bracket L-70 | 5304413856 |

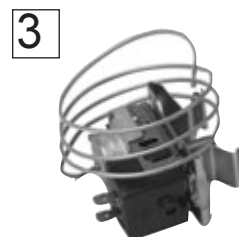
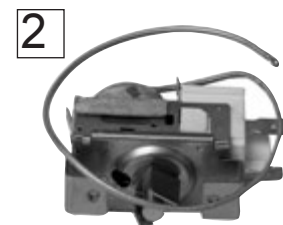

Defrost Timers

| Item # | Description | Part # |
|-----------|--------------------------------------|------------|
| 1 | Defrost Timer-6 hr 21 min- Universal | 5303917633 |
| 2 | Defrost Timer-8 hr 21 min- Universal | 5303917634 |
| 3 | Defrost Timer-12 hr | 216744400 |
| 4 | Defrost Timer (GM Frigidaire) | 5300628518 |
| Not Shown | Defrost Timer-6 hr 21 min | 215846604 |
| Not Shown | Defrost Timer-8 hr 21 min | 215846602 |

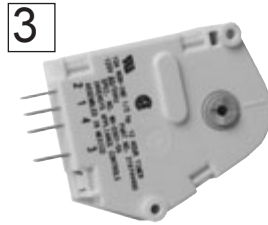
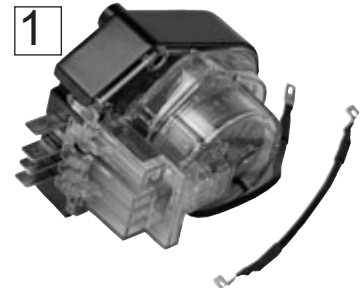

Door Gaskets

Freezer

| Item # | Description | Part # |
|-----------|--|------------|
| 1 | Gasket-Freezer Door, WH 27.62" x 16.62" | 5308007123 |
| Not Shown | Gasket-Freezer Door, ALD 30.69" x 16.69" | 5303276826 |
| Not Shown | Gasket-Freezer Door, WH 30.69" x 19.19" | 5318680314 |
| Not Shown | Gasket-Freezer Door, ALD 60.66" x 11.84" | 215019103 |
| Not Shown | Gasket-Freezer Door, ALD 60.66" x 14.59" | 215019106 |
| Not Shown | Gasket-Freezer Door, WH 27.62" x 16.62" | 5303288856 |



Refrigerator

| Item # | Description | Part # |
|-----------|---|------------|
| 1 | Gasket-Refr Door, WH 27.62" x 44.00" | 218730603 |
| Not Shown | Gasket-Freezer Door, WH 32.25" x 59.88" | 3206256 |
| Not Shown | Gasket-Refr Door, ALM 27.62" x 44.00" | 218730604 |
| Not Shown | Gasket-Refr Door, WH 29.24" x 44.00" | 5303207345 |
| Not Shown | Gasket-Refr Door, WH 30.69" x 44.06" | 218730609 |
| Not Shown | Gasket-Refr Door, ALM 30.69" x 44.06" | 218730610 |
| Not Shown | Gasket-Refr Door, ALM 40.03" x 30.44" | 5304404033 |
| Not Shown | Gasket-Refr Door, ALM 43.12" x 27.69" | 5303297557 |
| Not Shown | Gasket-Refr Door, ALM 60.66" x 17.66" | 215019101 |
| Not Shown | Gasket-Refr Door, ALM 60.66" x 19.59" | 215019102 |



Door Support

| Item # | Description | Part # |
|-----------|--------------------------------------|------------|
| 1 | Support-Door, Extends 1.06", RH | 3206165 |
| 2 | Support-Door, Extends 1.06", LH | 3206166 |
| 3 | Support-Door, Extends 1.81", RH | 3206150 |
| 4 | Support-Door, Rack, LH Extends 1.81" | 5303324302 |
| Not Shown | Rack-Door, 23.97" x .05" | 5303300237 |



Icemakers

| Item # | Description | Part # |
|-----------|-------------------------------------|------------|
| 1 | Ice Maker Kit, Next Gen, 115 V | IM115 |
| 2 | Ice Maker Kit, Radius Cube | 218734400 |
| 3 | Icemaker Kit Replacement | 5303918277 |
| Not Shown | Icemaker Kit (IM5) Forced Air 1992> | 218736300 |



Miscellaneous

| Item # | Description | Part # |
|--------|-------------------------------------|------------|
| 1 | Petrol Gel Refrig. Door Gasket Lube | 5303321429 |



Motors

| Item # | Description | Part # |
|-----------|---------------------------------|------------|
| 1 | Motor-Evaporator Fan Kit Refrig | 5300158289 |
| 2 | Motor-Evaporator Fan Kit Refrig | 5301137820 |
| 3 | Gear-Universal Refrigeration | 3206301 |
| 4 | Blower, Wheel | 5306598660 |
| Not shown | Motor-Evaporator Fan Kit Refrig | 5300715414 |

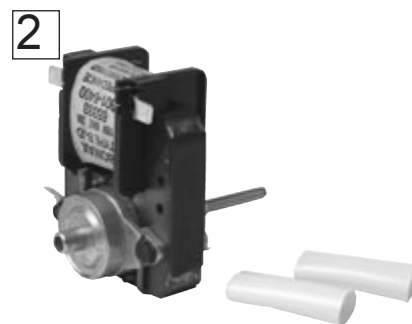
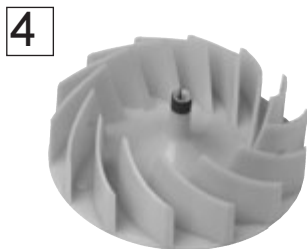
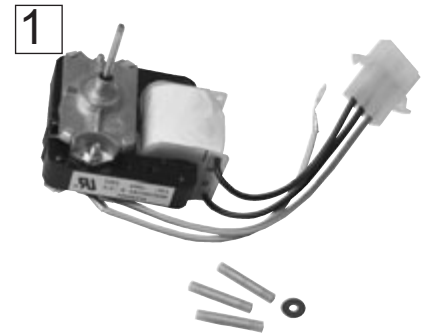

Water Valves

| Item # | Description | Part # |
|-----------|--------------------------------|------------|
| 1 | Valve Water, Universal Kit | 5303917098 |
| Not Shown | Valve Water, Dual Solenoid 115 | 215197400 |
| Not Shown | Valve Water, Dual Solenoid | 215372300 |
| Not Shown | Valve Water, Dual Solenoid 115 | 218658000 |
| Not Shown | Valve Water, Dual Solenoid 115 | 218698900 |
| Not Shown | Valve Water, Dual Solenoid 115 | 218832401 |
| Not Shown | Valve Water, Single Solenoid | 218470300 |
| Not Shown | Valve Water, Single Solenoid | 218859701 |

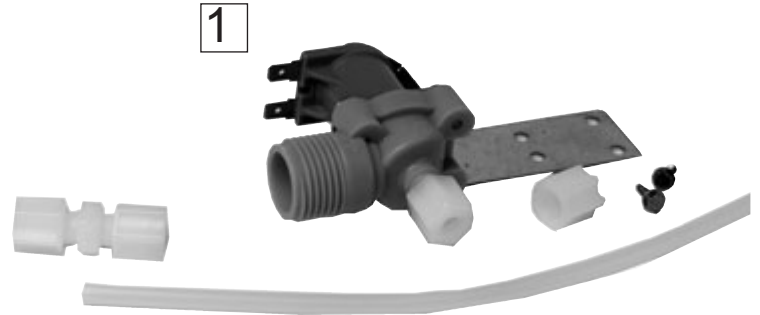

Range Accessories and Parts



Accessories

- Knobs
- Retail Packaged Parts
- Silicone Bakeware

Parts

- Backguard Kits
- Bowls
- Burners
- Electrical Connectors
- Filler Kits
- Flex Connectors
- Igniters
- LP Conversion Kits
- Surface Units
- Switches
- Trim Kits
- Trim Rings

Knobs



Electric Burner Knob Kit

Give your range a new look with our burner knob kits.

- Adjustable temperature rings
- Fits most Admiral, Amana, Brown, Caloric, Frigidaire, Gibson, Hardwick, Jenn Air, Kelvinator, Kitchen Aid, Magic Chef, Maytag, Tappan, Whirlpool, White-Westinghouse, and some Kenmore

P/N 5304431016

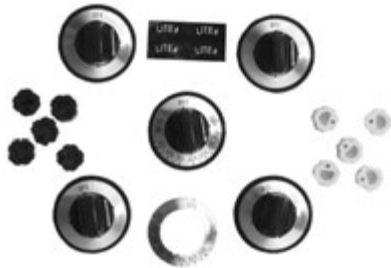

Gas Burner Knob Kit

Give your range a new look with our burner knob kits.

- Adjustable temperature rings
- Fits most Admiral, Amana, Brown, Caloric, Frigidaire, Gibson, Hardwick, Jenn Air, Kelvinator, Kitchen Aid, Magic Chef, Maytag, Tappan, Whirlpool, White-Westinghouse, and some Kenmore

P/N 5304431017

Retail Packaged Parts



4', 5/8" O.D. Range Gas Connector

Safety+Plus shuts off the gas supply to the appliance in the event of a catastrophic leak in the connection.

- Automatically resets, resuming appliance performance and continue protection
- Includes everything to connect your gas range to your gas shut-off valve

Kit Contents:

- 5/8 in. O.D. x 4 ft.
- Coated Stainless Steel Gas Connector with fitting
- Safety+Plus Automatic Shut Off-Valve, Leak Detection Solution
- Pipe Thread Sealant

P/N S5305514147



6', 40 Amp Range 3 Wire Power Cord

- Heavy duty, UL-approved
- 40 amperage ratings
- Easy and safe to hook-up
- Fits most major manufacturer's brands

P/N S53090-1054



6', 50 Amp Range 4 Wire Power Cord

- Heavy duty, UL-approved
- 50 amperage ratings
- Easy and safe to hook-up
- Fits most major manufacturer's brands

P/N S5305510956

Silicone Bakeware

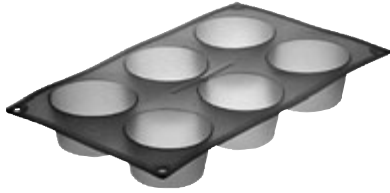

SILMUF6

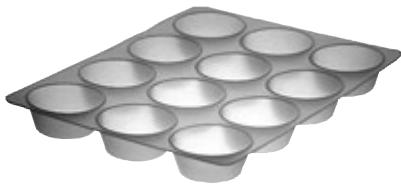

SILMUF12

These flexible, non-stick bake forms are of high quality and produce beautiful, well-formed bake goods. Professional and commercial chefs have been using silicone bakeware for years and have reaped the benefits of perfectly formed baked creations. Now you can have the same results with our high-quality silicone bakeware.

- Nonstick finish means flawless food release—simply peel away
- Non-porous so no residual odors or flavors
- Goes from oven to microwave to freezer without cracking or splitting apart
- Easy to clean—just wipe or rinse
- Dishwasher safe
- Flexible for easy storage
- Excellent heat conductivity reduces baking times by up to 30%
- Withstands up to 3000+ baking cycles and temperatures ranging from -40°F to 528°F

Also Available:

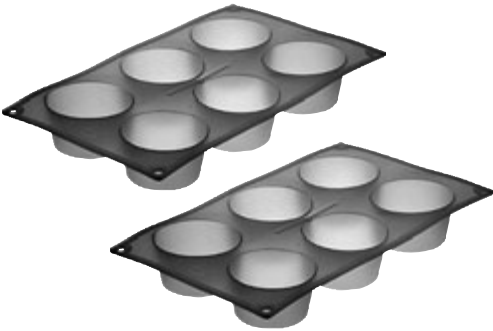

SILMUF6B

P/N SILMUF6
6 Cup Muffin Pan

P/N SILMUF12
12 Cup Muffin Pan

P/N SILMUF6B
Bundle / 2-6 Cup Muffin Pans

P/N SILLOAF
Loaf Pan

P/N SILBUNDT1
Bundt Pan

P/N SILSHEET
Cookie Sheet



SILLOAF



SILBUNDT1

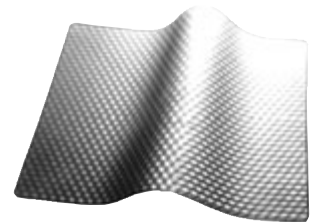

SILSHEET

Backguard Kits

For D line slide-in or drop-in ranges, example: PLES389DCA.

| Item # | Description | Part # |
|-----------|------------------------------|------------|
| Not Shown | 4" Black/Chrome Backguard | 5303293594 |
| Not Shown | 4" White/Chrome Backguard | 5303302433 |
| Not Shown | 4" Bisque/Chrome Backguard | 5304414342 |
| Not Shown | 4" Graphite/Chrome Backguard | 5304414343 |

1



Bowls

Universal (Fits most) Admiral, Amana, Brown, Caloric, Frigidaire, Gibson, Hardwick, JennAir, Kelvinator, Kitchen Aid, Magic Chef, Maytag, Tappan, Whirlpool, White-Westinghouse and some Kenmore

Specific: GE, Hotpoint, RCA, Kenmore

Universal

| Item # | Description | Part # |
|--------|--------------------------|------------|
| 1 | 6" Chrome Universal Bowl | 5304430992 |
| 2 | 8" Chrome Universal Bowl | 5304430998 |

1

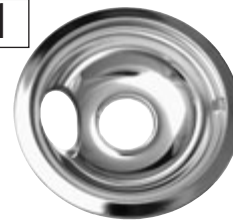

2



| Item # | Description | Part # |
|-----------|-----------------------------------|------------|
| 1 | 6" Porcelain Universal Bowl | 5304430997 |
| Not Shown | 6" Porcelain Black Universal Bowl | 5303935055 |
| Not Shown | 8" Porcelain Universal Bowl | 5304431003 |
| Not Shown | 8" Porcelain Drip Bowl/Clip | 5303935053 |

1



Specific:

| Item # | Description | Part # |
|--------|---------------------|------------|
| 1 | 6" Chrome Drip Bowl | 5304430993 |
| 2 | 8" Chrome Drip bowl | 5304430999 |

1



2

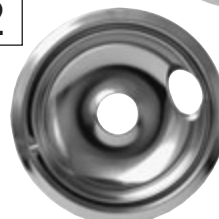

Specific:

| Item # | Description | Part # |
|--------|------------------------|------------|
| 1 | 6" Porcelain Drip Bowl | 5304430996 |
| 2 | 8" Porcelain Drip bowl | 5304431002 |



Burners

Universal (Fits most) Admiral, Amana, Brown, Caloric, Frigidaire, Gibson, Hardwick, JennAir, Kelvinator, Kitchen Aid, Magic Chef, Maytag, Tappan, Whirlpool, White-Westinghouse and some Kenmore

Specific: GE, Hotpoint, RCA, Kenmore

Universal

| Item # | Description | Part # |
|--------|---------------------------|------------|
| 1 | 6" Burner- 3 Turns Non-GE | 5303015716 |
| 2 | 6" Burner- 4 Turns Non-GE | 08067762 |
| 3 | 8" Burner- 4 Turns Non-GE | 5303015715 |
| 4 | 8" Burner- 5 Turns Non-GE | 5303012223 |

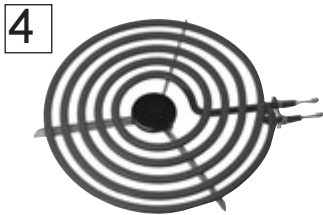
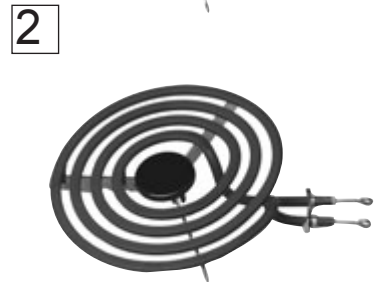
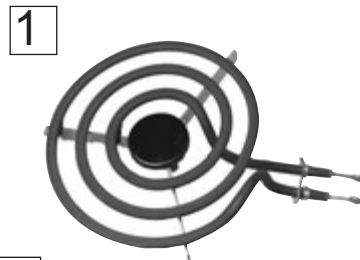

Specific:

| Item # | Description | Part # |
|-----------|---------------------|------------|
| 1 | 6" Burner-Post 1991 | 5304431025 |
| Not Shown | 8" Burner-Post 1991 | 5304431024 |



Electrical Connectors

| Item # | Description | Part # |
|--------|---|------------|
| 1 | Terminal, Straight Receptacle | 711T047P93 |
| 2 | Terminal, 1/4" Piggy-Back | 5303208039 |
| 3 | Terminal, Flag Receptacle Fully Insulated | 5304428350 |
| 4 | Terminal, Closed End Splice Tin | 3017781 |
| 5 | Terminal, Closed End Splice Tin Connector | C000505590 |
| 6 | Terminal, Straight Receptacle, Tin Connector | 5304425452 |
| 7 | Terminal, Straight Receptacle Line Splice | 0001468271 |
| 8 | Terminal, Flag Receptacle Fully Insulated Tin | 5304428350 |
| 9 | Terminal, Closed End Splice Translucent Tin | 5303303589 |
| 10 | Terminal, Sealable Connector, Nylon Housing | 3200568 |
| 11 | Terminal, Universal Nylon Mate-N-Lock | 5304430430 |

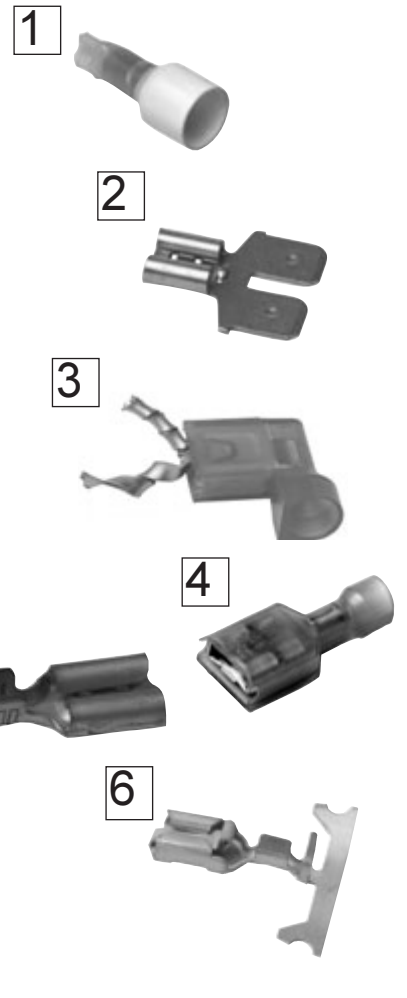

Elements

See Elements Chart on pg 21

| Item # | Description | Part # |
|-----------|---|------------|
| 1 | Element, Oven Bake with Wire Terminals | 5308003347 |
| Not Shown | Element, Oven Bake with Push on Terminals | 5309950885 |
| Not Shown | Element, Oven Bake with Large Terminals Extension | 5309950886 |
| Not Shown | Element, Oven Bake With Push on Terminals | 5309950887 |
| Not Shown | Element, Oven Bake with Push on Terminals | 5303051519 |
| Not Shown | Element, Bake, with Push on Terminals | 316075103 |
| Not Shown | Element, Bake, with Push on Terminals | 5303307010 |
| Not Shown | Element, 10 pk. of 5309950885 | 09990001 |
| Not Shown | Element, 10 pk. of 5309950886 | 09990002 |
| Not Shown | Element, 10 pk. of 5309950887 | 09990003 |

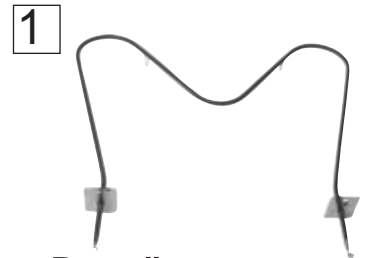

| | | | | | | | | | | | | |
|--|---|---|---|--|---|--|---|--|---|--|--|---|
| 19 1/2" x 15 1/8" x 3 3/4" 5303051519 200/240 VOLTS 1500/2000 WATTS Replaces: CH775, RP775, TS775 | 14 1/2" x 15 3/4" x 3 1/2" 5303051516 200/240 VOLTS 2500/3000 WATTS Replaces: CH4874, RP829, TS629 | 11 1/8" x 15 1/2" x 3 1/4" 5303051140 200/240 VOLTS 2215/2540 WATTS | 19 1/2" x 15 1/8" x 3 1/2" 5303207152 200/240 VOLTS 1500/2000 WATTS | 11" x 14 5/8" x 3" 5303207154 200 VOLTS 3000 WATTS | 17 3/4" x 15 3/8" x 3" 5303207158 200/240 VOLTS 1600/1900 WATTS | 17 1/16" x 10" x 3/4" 5303307010 200/240 VOLTS 1500/1700 WATTS | 19 1/4" x 15 1/8" x 3 1/4" 5309950886 200/240 VOLTS 2300/3500 WATTS | 13 1/2" x 19" x 3 3/8" 5309950887 200/230 VOLTS 2300/2000 WATTS Replaces: CH979, RP979, TS979 | 18 1/2" x 13 1/4" x 3 3/8" 5309950885 200 VOLTS 2475 WATTS Replaces: CH978, RP978, TS978 | 18 1/8" x 15 1/2" x 1 1/4" 5300207517 200/240 VOLTS 2200/5000 WATTS Replaces: CH641, RP641, TS641 | 18" x 15 1/4" x 2 1/2" 5300210911 200 VOLTS 3000 WATTS | 13 3/4" x 18" x 2 1/4" 09950891 200 VOLTS 2700 WATTS Replaces: CH969, RP969, TS969 |
|--|---|---|---|--|---|--|---|--|---|--|--|---|

Bake/Broil Oven Element Chart

Flex Connectors

| Item # | Description | Part # |
|-----------|--|------------|
| 1 | Gas Range Flex Connector, Stainless 4" L | 80145410 |
| Not shown | Gas Range Flex Connector, Stainless 4" L | 5303314147 |



Filler Kits

The filler kits fill up space in the rear of the range. Contains three filler strips, 1", 1.5", and 2".

| Item # | Description | Part # |
|-----------|-------------------|-------------|
| 1 | Filler Kit White | 901193-9011 |
| Not Shown | Filler Kit Black | 901193-9010 |
| Not Shown | Filler Kit Almond | 901193-9013 |
| Not Shown | Filler Kit Bisque | 901193-9014 |
| Not Shown | Filler Kit Bisque | 901193-9015 |

Igniters

| Item # | Description | Part # |
|--------|---|------------|
| 1 | Hot Surface Igniter | NR020 |
| 2 | Igniter Kit-Gas Oven | 5303912586 |
| 3 | Igniter-3.75" with Plug Replaces 3204718 | 316T023P05 |
| 4 | Igniter-Top burner with Mounting Bracket | 316011200 |
| 5 | Igniter-Oven with Bracket (Replaces Maytag's 12400) | 5312400035 |
| 6 | Igniter-Torpedo Replaced (Maytag's 303376) | 5304440277 |

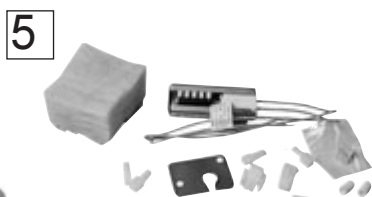
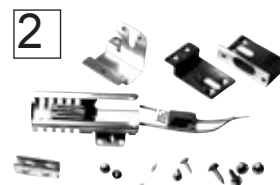
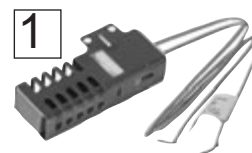

Igniters

Universal (Fits most) Admiral, Amana, Brown, Caloric, Frigidaire, Gibson, Hardwick, JennAir, Kelvinator, Kitchen Aid, Magic Chef, Maytag, Tappan, Whirlpool, White-Westinghouse and some Kenmore

Universal

| Item # | Description | Part # |
|--------|--------------------------|------------|
| 1 | Igniter- Universal 3.75" | 5303935066 |
| 2 | Igniter- Universal 5.5" | 5303935067 |
| 3 | Igniter- Universal 7.5" | 5303935068 |

1



3

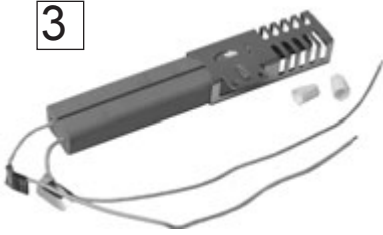

2



LP Conversion Kits

| Item # | Description | Part # |
|-----------|-----------------------|----------|
| 1 | LP Conv Kit | 80880210 |
| Not Shown | LP Conv Kit | 80880910 |
| Not Shown | LP Conv Kit (Gallery) | 80890410 |
| Not Shown | LP Conv Kit | 80990018 |
| Not Shown | LP Conv Kit | 80900010 |
| Not Shown | LP Conv Kit | GRLP2 |

1



Switches

| Item # | Description | Part # |
|-----------|--|------------|
| 1 | Surface Unit Switch Universal | 5303935086 |
| 2 | Surface Unit Switch, 240V Push Universal | 5303935089 |
| Not Shown | Surface Burner Infinite | 5308010418 |
| Not Shown | 6" Surface Burner Infinite | 5303051540 |
| Not Shown | 8" Surface Burner Infinite | 5309957099 |
| Not Shown | Surface Unit Kit (Replaces 530600491 and 5300600492) | 5303935129 |



Surface Elements

| Item # | Description | Part # |
|-----------|---|------------|
| 1 | 8" 5-Turn Canning Element (2600 w) | 81410610 |
| Not Shown | 8" Electric Element, 4 Turn Plug-in (2100 w) | 5303310280 |
| Not Shown | 6" Electric Element, 3 Turn Plug-in (12500 w) | 5303310281 |
| Not Shown | 8" Electric Element, 5 Turn Plug-in (2600 w) | 5303012223 |
| Not Shown | 6" Electric Element, 5 Turn Plug-in (1500 w) | 5303935058 |



Terminal Block

| Item # | Description | Part # |
|-----------|------------------------------------|------------|
| 1 | Terminal Block Kit Surface Element | 5301167733 |
| Not Shown | Terminal Block Kit Surface Element | 5303912666 |
| Not Shown | Terminal Block Kit Universal | 5303935058 |
| Not Shown | Terminal Block Kit Universal | 5304409888 |



Trim Kits

| Item # | Description | Part # |
|--------|--|-------------|
| 1 | Counter Top Trim Kit for 4" Backguard-Chrome | 903041-9010 |



Trim Rings

Universal (Fits most) Admiral, Amana, Brown, Caloric, Frigidaire, Gibson, Hardwick, JennAir, Kelvinator, Kitchen Aid, Magic Chef, Maytag, Tappan, Whirlpool, White-Westinghouse and some Kenmore

Specific: GE, Hotpoint, RCA, Kenmore

Universal

| Item # | Description | Part # |
|-----------|-------------------------------|------------|
| 1 | 6" Chrome Universal Trim Ring | 5304431009 |
| Not Shown | 8" Chrome Universal Trim Ring | 5304431011 |



Specific

| Item # | Description | Part # |
|-----------|------------------------|------------|
| 1 | 6" Chrome GE Trim Ring | 5304431008 |
| Not Shown | 8" Chrome GE Trim Ring | 5304431010 |



Rings and Bowls/Pans Compatability Chart

| Rings | Bowls/Pans |
|--|--|
| P/N 5304431009-6" Trim Ring (Universal) | P/N 5304430995-6" Drip Bowl (Universal) |
| P/N 5304431011-8" Trim Ring (Universal) | P/N 5304431001-8" Drip Bowl (Universal) |
| P/N 5304431008-6" Trim Ring (Specific) | P/N 5304430994-8" Drip Pan (Specific) |
| P/N 5304431010 8" Trim Ring (Specific) | P/N 530443100-8" Drip Pan (Specific) |

Dishwasher Dryer Washer Accessories and Parts

Accessories

Retail Packaged Parts

Parts

Dishwasher Install Kits
Dishwasher Repair Kits
Dishwasher Power Cords
Dryer/Washer Belts
Dryer Connectors
Dryer Cords
Impeller Seal Kits
Pumps
Rollers
Valves



Retailed Packaged Parts

Dryer



4', 1/2" O.D. Dryer Gas Connector

Stainless steel connectors, long lasting, corrosion resistant.

- Stainless steel connectors, long lasting, corrosion resistant
- No neck design for greater flexibility
- Both are 4' feet in length
- Fits most major manufacturer brands

P/N S5305514146



4', 3/8" O.D. Dryer Gas Connector

Stainless steel connectors, long lasting, corrosion resistant For use in Los Angeles Market.

- No neck design for greater flexibility
- Both are 4' feet in length
- Fits most major manufacturer brands

P/N S5305514925



8' Semi-Rigid Dryer Venting

Semi-rigid metal construction is flexible and easy to install yet rigid to protect from crushing.

- Enhances Drying times
- Expandable vent from 23 inches to 8 ft most common home installation requirements
- Custom fitted ends and clamps are designed to make installation quick and easy using common household tools

P/N S5305512431



0" to 5" Dryer Vent Periscope

Uniquely designed periscope allows close placement to wall in space-critical areas or your home.

- Metal clamps makes installation quick and easy using common household tool
- Vent adjusts 0 in. to 5 in. and pivots 100 degrees for direct / offset applications

P/N S5305516572

Accessories **Retailed Packaged Parts**

Dryer



6', 30 Amp Dryer 3 Wire Power Cord

Includes everything to connect your dryer to your electrical outlet.

Kit Contents:

- 6 ft. 3 Wire Dryer Cord
- Strain Release Safety Clamp
- Metal Screws

P/N S53055-1014



6', 30 Amp Dryer 4 Wire Power Cord

Includes everything to connect your dryer to your electrical outlet.

Kit Contents:

- 6 ft. 4 Wire Dryer Cord
- Strain Release Safety Clamp
- Metal Screws

P/N S5305510955



90 degree Close Elbow Dryer Vent

Uniquely designed elbow allows close placement to wall in space-critical areas of your home.

- Energy-efficient metal construction for safe operation
- Simple instructions make installation quick and easy using common house hold tools

P/N S5305514872

Retailed Packaged Parts

Washer



6', Stainless Steel Washer Fill Hose

Stainless Steel hoses provide superior strength and reliability over common rubber hoses. Includes everything to connect your clothes washer to your hot and cold water faucets.

Kit Contents:

- 2-6 ft Braided Stainless Steel Washer Hoses
- 4 Pliable Rubber Washers

P/N S5305516562

Dishwasher



6', Dishwasher Stainless Steel Install Kit

6 foot of stainless steel hose and adapters (elbow, inline T, Teflon tape) needed to hook up an under-counter dishwasher to water supply

- Easily installed with common tools
- Complete installation instructions included

P/N S5305516519

Belts

Dryer

| Item # | Description | Part # |
|-----------|---------------------------|-------------|
| 1 | Belt-Dryer 78.25" | 5308027638 |
| Not Shown | Belt-Drum Dryer 78.50" | 5303161099 |
| Not Shown | Belt-Dryer Grooved 87.75" | 13434503600 |
| Not shown | Belt-Dryer Flat 87.75" | 5303281154 |
| Not Shown | Belt-Dryer Grooved 89.00" | 5307537239 |
| Not Shown | Belt-Dryer 90.40" | 5300638957 |
| Not Shown | Belt-Dryer Grooved 91.20" | 5308057424 |



Washer

| Item # | Description | Part # |
|-----------|------------------------------|------------|
| 1 | Belt-Washer, 31" | 5303261153 |
| Not Shown | Belt-Washer, Flat, 31.50" | 5303280326 |
| Not Shown | Belt-Washer, Flat, 32.90" | 5300622451 |
| Not shown | Belt-Washer, Flat, 32.90" | 5308002451 |
| Not Shown | Belt V-Flat Washer Drive 35" | 134161100 |
| Not Shown | Belt-Washer, Flat, 41.50" | 5303261155 |
| Not Shown | Belt-Washer, Flat, 47.75" | 5303261151 |
| Not Shown | Belt-Washer, 65" | 5308001832 |



Connectors

Dryer

| Item # | Description | Part # |
|-----------|------------------------------------|------------|
| 1 | Dryer Connector, 1/2" OD Connector | 5303314146 |
| Not Shown | Dryer Connector, 3/8" OD Connector | 5304404925 |



Cords

Dryer

| Item # | Description | Part # |
|-----------|---|------------|
| 1 | 4' 30 amp cord w/eyelet terminal | 53090-1020 |
| Not Shown | 5' 30 amp cord w/eyelet terminal | 53090-1022 |
| Not Shown | 6' 30 amp cord w/eyelet terminal | 53090-1024 |
| Not Shown | 10' 30 amp cord w/eyelet terminal | 53090-1028 |
| Not Shown | 4' 30 amp 4 wire cord w/eyelet terminal | 5303325194 |
| Not Shown | 4' 30 amp 4 wire cord w/eyelet terminal | dc4x4 |
| Not Shown | 5' 30 amp 4 wire cord w/eyelet terminal | 5304415160 |
| Not Shown | 6' 30 amp 4 wire cord w/eyelet terminal | 5304410955 |



Elements

Dryer

| Item # | Description | Part # |
|-----------|--------------------------|------------|
| 1 | Element | 5303937005 |
| Not Shown | Element-Coil-Heater, .25 | 5300622032 |

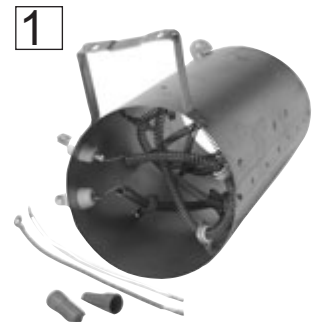

Impeller Seal

Dishwasher

| Item # | Description | Part # |
|-----------|-------------------|------------|
| 1 | Impeller Seal | 5300809110 |
| Not Shown | Impeller Seal Kit | 5300808042 |
| Not Shown | Impeller Seal Kit | 5300809116 |



Motors

Dryer

| Item # | Description | Part # |
|-----------|-------------------|------------|
| 1 | Motor (6.5 Mount) | 5300603182 |
| 2 | Motor Main | 5300603185 |
| Not Shown | Motor & Pulley | 5303283470 |

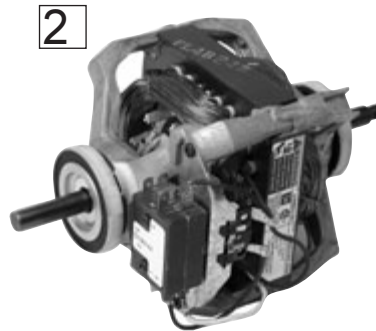
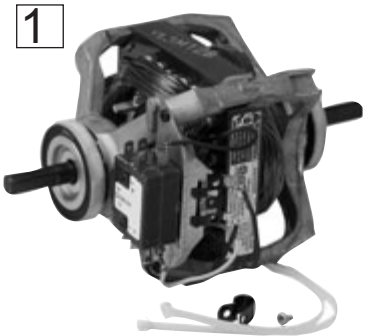

Washer

| Item # | Description | Part # |
|--------|-----------------------------|-----------|
| 1 | Motor w/Pulley 1SP 1/2" GHP | 134183200 |

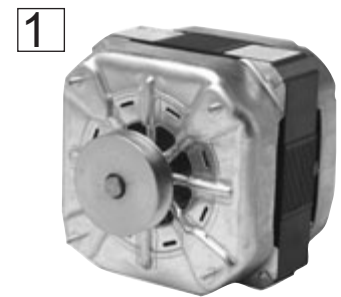

Pumps

Washer

| Item # | Description | Part # |
|-----------|-----------------|------------|
| 1 | Pump-Drain | 131208500 |
| Not Shown | Pump-Drain Assy | 131268401 |
| Not Shown | Pump-Drain Kit | 5303912510 |



Dishwasher

| Item # | Description | Part # |
|-----------|--------------|------------|
| Not Shown | Pump-Housing | 5300808964 |
| Not Shown | Pump-Housing | 5300809919 |
| Not Shown | Pump-Housing | 5033018307 |

Rollers

Dryer

| Item # | Description | Part # |
|---------------|--------------------|---------------|
| 1 | Roller, Drum | 5308057415 |
| Not Shown | Roller, Drum | 5308057416 |
| Not Shown | Roller, Drum | 5309956509 |



Valves

Washer

| Item # | Description | Part # |
|---------------|-----------------------------------|---------------|
| 1 | Valve-Fill (Fits 1980 to Current) | 134190200 |



Outdoor Kitchen Accessories

Accessories

Bake Stones

Conversion Kits

Griddles

Grill Covers

Oven Mitts

Rotisseries

Stainless Steel Side Burners

Stainless Steel Smoker Boxes

Stainless Steel Trim Kits



Bake Stones



12" Bake Stone

Our bake stone sits directly on the grill's cooking grates, creating an 'Italian brick oven'.

- The stone's unique surface "wicks away" moisture, creating perfect crusts every time
- Absorbs moisture and distributes heat evenly
- Easy to clean and store

P/N PS12E

Conversion Kits



Parts ending in "DC" fit 2004 grills only
Parts ending in "EC" fit 2005 grills only

Liquid Propane to Natural Gas

Convert your grill from liquid propane to natural gas with our conversion kit.

Frigidaire 2004 Grill Conversion Kit

26" P/N CC26NGDC

27" P/N CC27NGDC

Gallery 2004 Grill Conversion Kit

30" P/N CC30NGDC

38" P/N CC38NGDC

Electrolux 2004 Grill Conversion Kit

44" P/N CC44NGDC

50" P/N CC51NGDC

Frigidaire 2005 Grill Conversion Kit

26" P/N CC26NGEC

27" P/N CC27NGEC

Gallery 2005 Grill Conversion Kit

30" P/N CC30NGEC

38" P/N CC38NGEC

Electrolux 2005 Grill Conversion Kit

44" P/N CC44NGEC

51" P/N CC51NGEC

Conversion Kits



Parts ending in "DC" fit 2004 grills only
 Parts ending in "EC" fit 2005 grills only

Natural Gas to Liquid Propane

Convert your grill from natural gas to liquid propane with our conversion kit.

Frigidaire 2004 Grill Conversion Kit

26" P/N CC26LPDC
 27" P/N CC27LPDC

Gallery 2004 Grill Conversion Kit

30" P/N CC30LPDC
 38" P/N CC38LPDC

Electrolux 2004 Grill Conversion Kit

44" P/N CC44LPDC
 50" P/N CC51LPDC

Frigidaire 2005 Grill Conversion Kit

26" P/N CC26LPEC
 27" P/N CC27LPEC

Gallery 2005 Grill Conversion Kit

30" P/N CC30LPEC
 38" P/N CC38LPEC

Electrolux 2005 Grill Conversion Kit

44" P/N CC44LPEC
 51" P/N CC51LPEC

Griddles



Our non-stick griddle is double-sided. One side features grooves for bacon, sausage, or searing fruit, and a smooth side perfect for pancakes, crepes, or eggs.

- Ribbed design is perfect for cooking food above the fat.
- Dimensions: 19.5" L x 11" W x 1" T

Griddle Non-Stick-Double-Sided P/N GD01EB
Universal Griddle P/N ULTGRIDLE

Grill Covers



Protect your investment and guard against the elements with our premium grill covers. These grill covers are customized to fit your Frigidaire or Electrolux grill.

- Constructed of heavy-duty PVC with a 70D Nylon lining
- Velcro closure tabs at the bottom to ensure a snug fit
- Cover features the Electrolux or Frigidaire logo and comes in 26", 27", 30", 38", 44", 51", and 57" sizes

2004 Grill Covers

| | |
|-----------------------|------------|
| 26" Frigidaire grills | P/N GC26DB |
| 44" Frigidaire grills | P/N GC44DB |
| 51" Frigidaire grills | P/N GC51DB |

2004 and 2005 Grill Covers

| | |
|-----------------------|------------|
| 30" Frigidaire grills | P/N GC30EB |
| 38" Frigidaire grills | P/N GC38EB |

2005 Grill Covers

| | |
|-----------------------|------------|
| 26" Frigidaire grills | P/N GC26EB |
| 27" Frigidaire grills | P/N GC27EB |

Electrolux

| | |
|-----------------------|------------|
| 44" Electrolux grills | P/N GC44EB |
| 51" Electrolux grills | P/N GC51EB |
| 57" Electrolux grills | P/N GC57EB |

Oven Mitts



Protect yourself and your family from dangerous scalds or burns with these revolutionary oven mitts and pot holders. They are great to use outside when grilling or in the kitchen with anything requiring exposure to heat or freezing conditions (cleaning the freezer-no more frozen fingers when you use Kitchen Grips).

These revolutionary mitts and pot holders feature:

- Nonslip grip
- Stain resistance
- Water resistance
- Heat resistance up to 500°F
- Also Available in: Red and Blue.
- Comes with oven mitt and pot holder

Blue Kitchen Grips P/N GMBLUEC
Red Kitchen Grip P/N GMREDEC

Rotisseries



Your roasts and fowls will come out succulent and tender with our Stainless Steel Rotisserie Kit. Deluxe stainless steel motor easily handles up to 20 lbs of food.

Our kit includes the spit and 2 meat forks and comes in 5 sizes: 26", 27", 30", 38", 44", 51", 57".

These rotisseries are for use on Electrolux and/or Frigidaire grills.

2004 Stainless Steel Rotisserie
 26" P/N RT26DC
 30" P/N RT30DC
 38" P/N RT38DC
 44" P/N RT44DC
 51" P/N RT51DC

2005 Stainless Steel Rotisserie
 26" P/N RT26EC
 30" P/N RT30EC
 38" P/N RT38EC
 44" P/N RT44EC
 51" P/N RT51EC

Side Burners



Single Side Burner

Provide extra cooking space for your built-in grill.

- 1 sealed 12,000 BTU burner
- Dimensions: 21 1/16" W x 11 25/32" H x 4 3/16" D

P/N SB01EC



Dual Side Burner

Provide extra cooking space for your built-in grill.

- 1 sealed 12,000 BTU burner and 1 sealed 17,000 BTU burner
- Dimensions: 24" W x 11 11/16" H x 6 1/8" D

P/N SB02EC

Smoker Boxes



Add authentic smoked flavor to any meal with our stainless steel smoker box.

- Unique design fits over one burner maximizing grill top space.
- 1 sealed 15,000 BTU burner

* Stainless steel smoker box kit is NOT universal. It is only for use with Frigidaire and Electrolux grills only.

Fits 2004 Grills

P/N SM01DC

(For 30", 38", 44", and 51" 2004 Frigidaire grills)

Fits 2005 Grills

P/N SM01EC

(For 30" and 38" 2005 Frigidaire grills, and 44" 2005 Electrolux grills)

P/N SM02EC

(For 51" and 57" 2005 Electrolux grills)

P/N SM03EC

(For 26" and 27" 2005 Frigidaire grills)

Tool Kits



Stainless Steel 5 pc.

Deluxe tool set features long handles to keep hands out of the heat while grilling steaks and chops.

- Solid stainless construction
- Stylish aluminum carrying case make it easy to transport and store.

Includes the following pieces:

- 4-in-1 Spatula
- Fork
- Tongs
- Basting brush
- Knife

P/N TL01EC



Stainless Steel 5 pc. w/Rosewood Handles

Cook like a professional with our high-quality stainless steel and rosewood tool kit. Premium grill utensils encased in rosewood. Stylish hardwood carrying case makes it easy to transport and store.

Includes the following pieces:

- Spatula
- Grill fork
- Tongs
- Basting
- Brush
- Knife

P/N TL04EC



Stainless Steel 30 pc.

The Ultimate BBQ Tool has everything you need for that Saturday afternoon grill fest. You provide the food, these tools will help with the cooking.

Includes the following pieces:

- 4-in-1 spatula
- Fork
- Tongs
- Basting brush
- Knife
- 6 skewers
- 12 corn holders
- Grill brush with replaceable head and 1 replacement heads
- 4 steak house knives

P/N TL03EC

Home Comfort Accessories

Accessories
Anti-Microbial Filters
Support Brackets
Weather Seals



Accessories

Anti-Microbial Filters

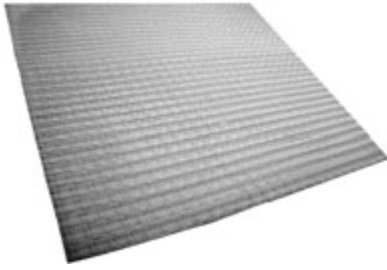

Anti-Microbial filter

Universal, antimicrobial, cut-to-fit filter fits all standard A/C units, as well as central air units (just place filter between air return gate and standard air filter).

- Lasts six times longer than standard foam filters
- simple 'cut to fit' design—simply measure, cut and install with the flat side toward the compressor
- 100% Washable— Rinse with warm water, dry, and replace.
- Anti-Microbial Filter resists growth of: bacteria mold and fungus.

P/N 5304405648

Support Brackets

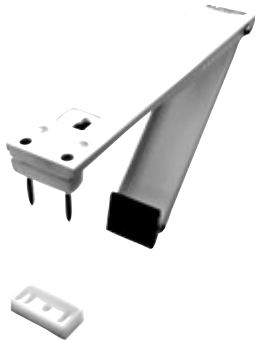

Large Support Bracket

Ensure your window unit is secure by using our universal support bracket. Built for all-weather use and easy indoor installation, eliminating the need to work outside.

- Supports units weighing up to 160 lbs.
- Built for 12,000 BTU to 24,000 BTU
- Universal support brackets fit standard A/C units

P/N AC-160



Small Support Bracket

Ensure your window unit is secure by using our universal support bracket.

- Supports units weighing up to 80 lbs.
- Built for 5,000 BTU to 10,000 BTU,
- Universal support brackets fit standard A/C units

P/N AC-080

Weather Seals



Weather Seal

Seals out cold drafts in winter, and seals cold air in during summer.

- Reduces window vibration and outside noises
- Seals out dust and insects
- Foam compresses easily to seal window gap around unit
- Can also be used as a window sash seal

P/N 530442631 1

Service Company Accessories

Accessories

Appliance Mat
Bundle

Counter Mat

Embroidered Hat

Embroidered Patch

Magnetic Vehicle Sign

Protective Shoe Booties



Bundle



Bundle

Our bundles contain one of each item at a special price.

Bundle includes following items:

- Embroidered Patch
- Embroidered Towel
- Embroidered Hat
- Protective Shoe Booties (lg. or sm. shoe covers)
- Magnetic Vehicle Sign
- Counter Mat
- Large Appliance Mat

P/N ELECBLNDLG

(Everything listed above including large shoe covers)

P/N ELECBLNDSM

(Everything listed above including small shoe covers)

Appliance Mat

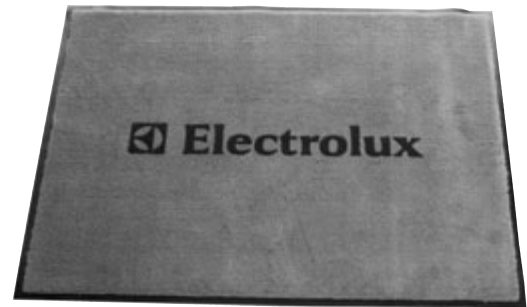

3' x 4' Appliance Mat

Use our foam-backed floor mat(s) to move larger appliances onto as well as rest tools. You will prevent damage to your customer's floors and minimize wear and tear on your knees and back.

- Dimensions: 3' x 4'

P/N ELECFLRMAT8

Counter Mat



Use our foam-backed counter mat(s) to rest tools on as well as to kneel on. You will prevent damage to your customer's floors and countertops, as well as wear and tear on your knees and back.

- Dimensions: 10" x 15" with 1/8" foam back

P/N ELECCTRMAT4

Embroidered Electrolux Items



Hat

Top off your professional Electrolux look with our exclusive Electrolux hat. By wearing this hat, your customers will know that you take pride in your appearance!

P/N ELECCAP2



Shirt Patch

Distinguish yourself as an authorized Electrolux servicer. Display your Electrolux patch on your shirt sleeve or shirt pocket and let your customers know that you're part of a select group of professionals!

- Dimensions: 2-1/2" x 2-1/2"

P/N ELECPATCH3

Magnetic Vehicle Sign



Attach our magnetic logo to your truck or van for easy identification as an authorized Electrolux repair person.

- Dimensions: 12" Square

P/N ELECMAGSIGN1

Protective Shoe Booties

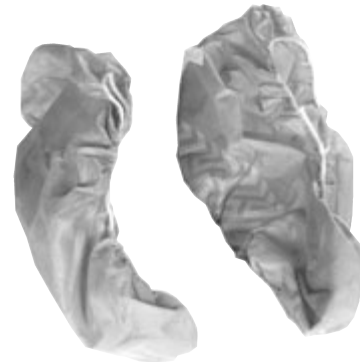

Shoe booties prevent dirt from being tracked into your customer's home as well as prevent scuffing or smudging expensive flooring. Your customers will appreciate your extra consideration for their property.

- Large size fits shoe sizes 12+
- Small fits shoe sizes 1-11.
- Protective shoes only come in quantities of 10.

P/N ELECSHOEST6

(Protective Shoe Booties Small)

P/N ELECSHOELG7

(Protective Shoe Booties Large)

Cleaners and Cosmetic Repair Products



Cleaners



Cerama Bryte Cooktop Cleaner (18 oz.)

Cleans glass and ceramic cooking surfaces without scratching. Safe and effective on cold or warm surfaces.

- Remove baked on food stains and spills
- Biodegradable and non-toxic
- Great for daily use to maintain the look and performance of your ceramic and glass cooktop
- May also be used on stainless steel cookware and sinks as well as porcelain sinks
- Lemon scented
- Convenient lotion solution in a squeeze bottle
- 18 oz. bottle

P/N 5304433208



Cooktop Cleaner (20 oz.)

This cooktop cleaner shines and protects in one easy step. It keeps your new range beautiful and brings old or damaged ones back to life.

P/N 5303321670



Ceramic Cleaner (13 oz.)

Cleans glass and ceramic cooking surfaces without scratching.

- Safe and effective on cold or warm surfaces
- Contains 13 fl. oz.

P/N 5305514077



Glisten

Keep your dishwasher clean and fresh with Glisten Dishwasher Cleaner. Gets your dishwasher sparkling clean & lemon fresh.

- Glisten works hard to remove built-up soap scum, food stains, and discoloration due to iron and other water impurities
- For use with most major manufacturer's brands
- Comes in 3 oz package
Note: Do not mix Glisten with bleach

P/N 5303319027

Cleaners



Kitchen Care Kit

Our non-abrasive kitchen cleaners help make appliances look beautiful for years to come.

- Cerama Bryte cooktop cleaner works hard to remove tough, baked-on food stains and spills.
- Stainless steel cleaner provides superior protection and guards against smudges.
- Microfiber sponge gently and effectively wipes away tough stains.
- Scraper safely assists in removing burned on deposits from ceramic cooktops without scratching

Kit Contains

- 2.5 oz. Cerama Bryte
- 2.5 oz. Stainless Steel Cleaner
- Scraper
- Microfiber Sponge

P/N 5304436288



Stainless Steel Cleaner (4 oz.)

For use with all stainless steel cleaning applications.

- Put an end to water spotting
- Won't scratch or streak
- Cleans and shines appliances

P/N 5304409707



Range Element Cleaner

- Improves appearance
- Restores and protects solid elements
- For use with most major manufacturers brands

P/N 5303310267



Stainless Steel Cleaner Spray (16 oz.)

Our stainless steel cleaner provides superior protection and guards against smudges.

- Spray-trigger is designed to work great on larger surfaces to cover more area
- Great to use on all stainless steel appliances

P/N 5304433275

Cleaners



Stainless Steel Cleaning Polish Conditioner Wipes

- Protects stainless steel surfaces
- Contains mineral oil
- Protects against spots
- Leaves protective shine
- Removes fingerprints and smoothes the smudges
- Leaves an even, streak-free surface
- Removes water spots and food stains
- Convenient for touch-ups and spot cleaning
- Ready to use right out of the canister
- Quick and easy application

P/N 5305512345

Touch-Up Paints



Touch-up Paint

Touch-up those dings and scratches in your appliance! Freshen the appearance of your stove, refrigerator, dishwasher, laundry center, washer, dryer, or any appliance!

- Available in White, Almond, Black, Bisque, and Graphite
- Size: 0.6 fl.oz.

| | |
|-----------------------|-----------------|
| White Touch-up Paint | P/N 55303321319 |
| Black Touch-up Paint | P/N 5303310271 |
| Almond Touch-up Paint | P/N 5303310269 |
| Bique Touch-up Paint | P/N 5304414035 |

○

Frigidaire
