



*Spare parts suitable for:*  
***ELETTROBAR/WOLK***



**G.E.V. Großküchen-Ersatzteil-Vertrieb GmbH**  
Robert-Koch-Straße 3a  
82152 Planegg/Munich  
Germany

Phone: +49 (0)89 745572-0  
Fax: +49 (0)89 745572-83  
order@gev-online.com  
www.gev-online.com

Member of the  **GEV GROUP**





Wash and rinse systems

Page 4



Various and air traps

Page 19



Drain and filter systems

Page 21

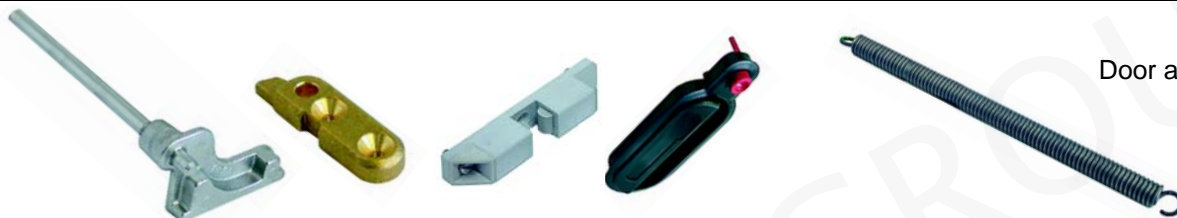

Door and hood components

Page 26



Electrical components

Page 28



Dosing pumps

Page 35



Heating elements and boilers

Page 36



Pumps and components

Page 38

## F Wash and rinse systems

Suitable for Electrobar/Wolk

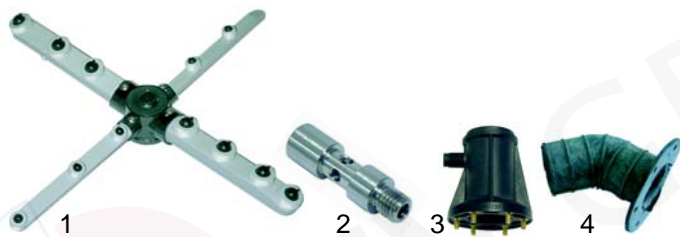

Item	Order	Description	Model	OEM
1	510119	wash and rinse arm compl.	S621, S623, S624,	990008
2	510108	rinse arm spindle	S626, S631, S634,	327006
3	510031	wash arm support	S636,	115002
4	518036	gasket (outlet hose)	21f, 21fd, 31f, 31fd,	127012
			25f, 25fd, 30f, 30fd	



Item	Order	Description	Model	OEM
1	518386	wash arm fixed compl.		990056
2	510146	wash jet	21f, 21fd, 31f,	119003
3	510144	union nut wash jet	31fd, 25f, 25fd,	140010
4	510135	wash arm support	30f, 30fd	110001



Item	Order	Description	Model	OEM
1	510010	wash arm cross		129003
2	518382	wash arm right		106009
3	518385	wash arm left		106012
4	518384	rinse arm right	S621, S623, S624,	106011
5	518383	rinse arm left	S626, S631, S634,	106010
6	518004	wash jet	S636,	140008
7	510131	union nut wash jet	21f, 21fd, 31f, 31fd,	429007
8	510139	rinse jet	25f, 25fd, 30f, 30fd	140007
9	510130	union nut rinse jet		429006



Item	Order	Description	Model	OEM
1	518005	wash and rinse arm compl.	S651, S653, S654,	990009
2	510108	rinse arm spindle	S655, S830, S835,	327006
3	518009	wash arm support	S850	115013
4	518387	wash arm support	S651, S653, S654,	115015
5	518008	gasket	S655, S830, S835,	437016
			S850	



Item	Order	Description	Model	OEM
1	510118	rinse arm compl.	S621, S623, S624,	993031
2	518328	rinse arm right	S626, S631, S634,	106036
3	518329	rinse arm left	S636,	106035
4	510139	rinse jet	21f, 21fd, 31f, 31fd,	140007
5	510130	union nut rinse jet	25f, 25fd, 30f, 30fd	429006



Item	Order	Description	Model	OEM
1	510010	wash arm cross		129003
2	518332	wash arm right		106008
3	518333	wash arm left		106006
4	518334	rinse arm right	S651, S653, S654,	106007
5	518335	rinse arm left	S655, S830, S835,	106005
6	518004	wash jet	S850	140008
7	510131	union nut wash jet		429007
8	510139	rinse jet		140007
9	510130	union nut rinse jet		429006



Item	Order	Description	Model	OEM
1	518007	rinse arm		993030
2	510140	union nut rinse jet		140006
3	510137	rinse spiral		138001
4	510134	rinse jet holder	S651, S654, S810,	468055
5	510113	spring clip	S815, S830, S835	449029
6	518017	end cap blind		145002
7	518016	end cap with jet		145001



Item	Order	Description	Model	OEM
1	518179	wash arm bearing upper		429055
2	518178	wash arm bearing lower		429052
3	518180	bearing ring	Clean 3	303018
4	518181	holder		429053
5	518058	O-ring		456052
6	518183	support		115088



Item	Order	Description	Model	OEM
1	518053	wash arm nut		429030
2	518012	bearing ring		308015
3	518013	wash arm bearing	S651, S654, S810,	478021
4	518014	rinse arm spindle	S815, S830, S835	325011
5	518015	double disc		199001
6	518010	wash arm column		115020
7	518008	gasket		437016

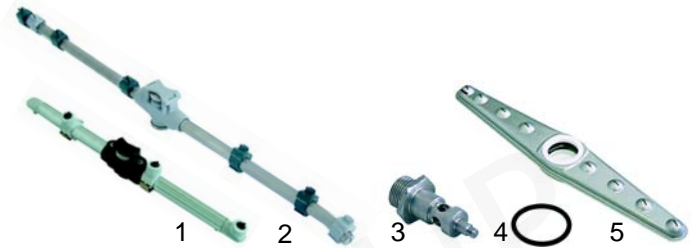

Item	Order	Description	Model	OEM
1	518392	rinse arm compl. upper		993041
2	518274	rinse arm compl. lower	44f, 440f	993047
3	518034	rinse arm spindle upper		325031
4	518393	gasket		437042
5	518019	wash arm lower		990055



Item	Order	Description	Model	OEM
1	518053	wash arm nut		429030
2	511143	bearing ring	44f, 440f	303009
3	511142	wash arm bearing		478037
4	518014	rinse arm spindle lower		325011
5	518394	disc		199027

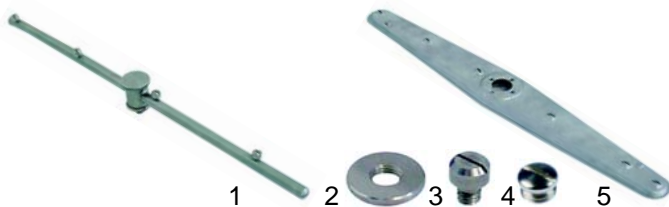

Item	Order	Description	Model	OEM
1	518388	rinse arm compl.		993043 113992 325046
2	518390	disc	Clean 3	429058
3	518164	rinse jet		140019
4	518391	end cap		480065
5	518157	wash arm lower		129034
5	518316	wash arm upper		129036



Item	Order	Description	Model	OEM
1	518031	wash arm support		115075
2	518210	gasket		437015
3	518150	gasket	44f, 440f	441009
4	518170	rinse arm		143174
5	518171	support		111019

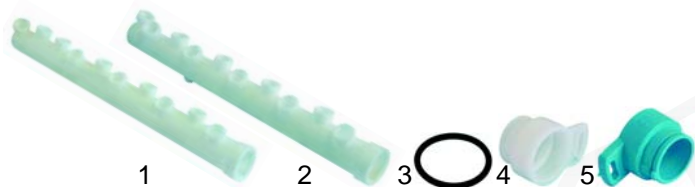

Item	Order	Description	Model	OEM
1	518396	wash arm fixed right	44f, 440f	106044
2	518397	wash arm fixed left		106043
3	518398	O-ring		456046
4	518399	coupling right		127030
5	518400	coupling left		127029



Item	Order	Description	Model	OEM
1	518401	angle owner	44f, 440f	108007
2	518402	gasket		437050
3	518403	wash arm support		127028
4	518039	wash arm end cap		480045
5	510147	wash jet		119004
6	510007	union nut wash jet		140014



Item	Order	Description	Model	OEM
1	518404	wash and rinse arm compl.	45, 450	990078
2	510108	rinse arm spindle		327006
3	518049	throttle disc		199034
4	518168	wash arm support		115094
5	518025	gasket		437014
6	513102	support		926052



Item	Order	Description	Model	OEM
1	518404	wash and rinse arm compl. lower	46, 460	990078
2	518405	rinse arm spindle		325045
3	518337	throttle disc		199039
4	518024	wash arm support		115076
5	518025	gasket		437014
6	518171	support		111019



Item	Order	Description	Model	OEM
1	510010	wash arm cross lower		129039
2	518406	wash arm right		106045
3	518407	wash arm left		106092
4	518408	rinse arm right		106093
5	518409	rinse arm left		106094
6	510138	wash jet		140013 140020
7	518272	union nut wash jet		429040
8	510139	rinse jet		140007
9	518053	union nut rinse jet		429039



Item	Order	Description	Model	OEM
1	518314	wash arm fixed		990082
2	518317	rinse arm		993036
3	510146	wash jet		119003
4	510144	union nut wash jet	45, 450	140010
5	518159	wash jet holder		110010
6	518410	wash arm end cap		441010
7	510139	rinse jet		140007
8	518053	union nut rinse jet		429039



Item	Order	Description	Model	OEM
1	518411	wash and rinse arm compl. upper	46, 460	990077
2	510108	rinse arm spindle		327006
3	518338	wash arm support		115074



Item	Order	Description	Model	OEM
1	510010	wash arm cross upper		129003 129039
2	518412	wash arm right		106090
3	518413	wash arm left		106091
4	518414	rinse arm right	46, 460	106048
5	518415	rinse arm left		106047
6	510138	wash jet		140013 140020
7	518272	union nut wash jet		429040
8	510139	rinse jet		140007
9	518053	union nut rinse jet		429039



Item	Order	Description	Model	OEM
1	518269	wash and rinse arm compl. upper	050F, 050FP, 50f, 50fd,	990061 990108
2	510108	rinse arm spindle	50f electronic,	327006
3	518339	gasket	500f, 500fd	437064
4	518338	holder		115074



Item	Order	Description	Model	OEM
1	510010	wash arm cross upper		129039
2	518332	wash arm right		106008
3	518333	wash arm left	050F, 050FP,	106006
4	518334	rinse arm right	50f, 50fd,	106007
5	518335	rinse arm left	50f electronic,	106005
6	518004	wash jet	500f, 500fd	140008
7	518272	union nut wash jet		429040
8	510139	rinse jet		140007
9	518053	union nut rinse jet		429039

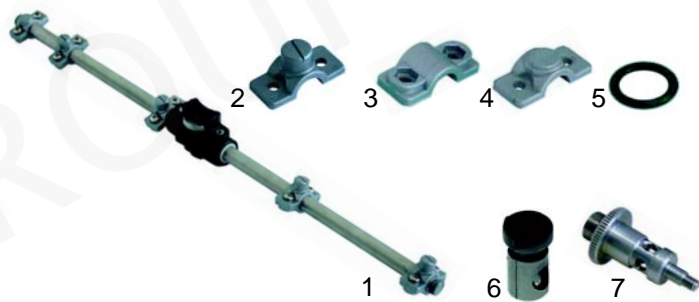

Item	Order	Description	Model	OEM
1	518271	rinse arm compl.		993045
2	513055	rinse jet		926133
3	518416	rinse jet clamp		926131
4	518417	blind jet	050F, 050FP	926168
5	518418	O-ring		456030
6	518419	end cap		926132
7	513122	rinse arm spindle		926130



Item	Order	Description	Model	OEM
1	518270	wash arm		129046
2	518420	rinse arm	050F, 050FP	926154
3	518032	throttle disc		199027
4	518024	wash arm support		115076
5	518025	gasket		437014



Item	Order	Description	Model	OEM
1	518150	cuff		441009
2	518170	rinse arm	050F, 050FP	143174
3	518343	support		111031



Item	Order	Description	Model	OEM
1	518020	rinse arm lower compl.		993037
2	510139	wash jet		140007
3	510130	union nut rinse jet	50f, 50fd,	429006
4	511149	rinse jet holder right	50 electronic,	468124
5	511150	rinse jet holder left	500f, 500fd	468125
6	510113	clip		449029
7	518035	end cap		145004
8	510159	end cap with jet		145003



Item	Order	Description	Model	OEM
1	518001	wash and rinse arm compl.		990046
2	510108	rinse arm spindle	11f, 11fd,	327006
3	510058	throttle disc	11f (DVGW)	199018
4	510037	wash arm support		115035
5	510054	gasket		437046



Item	Order	Description	Model	OEM
1	518019	wash arm lower		990055
2	511144	nut		429030
3	511143	bearing ring	50f, 50fd,	303009
4	511142	wash arm bearing	50 electronic, 500f,	478037
5	518014	rinse arm spindle	500fd	325011
6	518032	throttle disc		199027

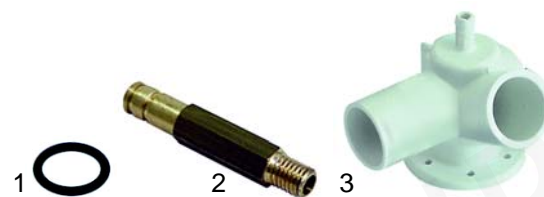

Item	Order	Description	Model	OEM
1	510055	O-ring		456019
2	510056	rinse arm		325025
3	518421	support (DVGW), rinse connection closed	11f, 11fd, 11f (DVGW)	111015
3	518171	support, rinse connection open		111019



Item	Order	Description	Model	OEM
1	518031	wash arm support		115075
2	518025	gasket	50f, 50fd,	437014
3	518150	cuff	50 electronic, 500f,	441009
4	518170	rinse arm	500fd	143174
5	518171	support		111019



Item	Order	Description	Model	OEM
1	510010	wash arm cross		129003 129039
2	518382	wash arm right		106009
3	518385	wash arm left		106012
4	518384	rinse arm right	11f, 11fd,	106011
5	518383	rinse arm left	11f (DVGW)	106010
6	510138	wash jet		140013 140020
7	510131	union nut wash jet		429007
8	510139	rinse jet		140007
9	510130	union nut rinse jet		429006





Item	Order	Description	Model	OEM
1	510118	rinse arm compl.		993031
2	518328	rinse arm right		106036
3	518329	rinse arm left	11f, 11fd, 11f (DVGW)	106035
4	510139	rinse jet		140007
5	510130	union nut rinse jet		429006



Item	Order	Description	Model	OEM
1	518019	wash arm		990055
2	511144	wash arm support		429030
3	511143	bearing ring	22f, 40f (DVGW)	303009
4	511142	wash arm bearing		478037
5	518014	rinse arm spindle		325011
6	518032	throttle disc		199027



Item	Order	Description	Model	OEM
1	510146	wash spinner fixed arm		119003
2	510144	union nut wash jet	11f, 11fd, 11f (DVGW)	140010
3	510135	wash jet holder		110001



Item	Order	Description	Model	OEM
1	518033	wash arm column	22f, 40f (DVGW)	115045
2	518025	gasket		437014
3	518304	support		111013



Item	Order	Description	Model	OEM
1	518022	rinse arm upper		993038
2	518020	rinse arm lower	22f, 40f (DVGW)	993037
3	518034	rinse arm spindle upper		325031



Item	Order	Description	Model	OEM
1	518396	wash arm right		106044
2	518397	wash arm eft		106043
3	518399	coupling right		127030
4	518400	coupling left	22f, 40f (DVGW)	127029
5	518398	O-ring		456046
6	518403	wash arm support		127028
7	518402	gasket		437050
8	518401	support		108007

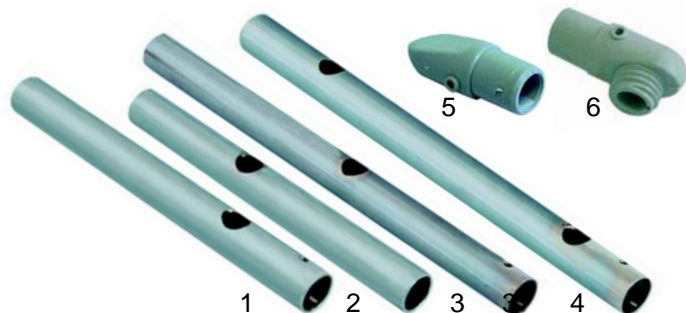

Item	Order	Description	Model	OEM
1	518422	rinse arm right upper		106055CR
2	518423	rinse arm left upper		106056CR
3	518424	rinse arm right lower	22f, 40f (DVGW)	106053CR
4	518425	rinse arm left lower		106054CR
5	518035	end cap		145004
6	510159	end cap with jet		145003



Item	Order	Description	Model	OEM
1	510147	wash jet		119004
2	510007	union nut wash jet		140014
3	510139	rinse jet	22f,	140007
4	510130	union nut rinse jet	40f (DVGW)	429006
5	511149	rinse jet holder right		468124
6	511150	rinse jet holder left		468125
7	510113	clip		449029



Item	Order	Description	Model	OEM
1	510118	rinse arm compl.		993031
2	518443	rinse arm holder	35f, 35fd,	468142
3	518240	gasket	35 electronic, 350f, 350fd	437062 437078
4	518434	nut		429050



Item	Order	Description	Model	OEM
1	518426	wash and rinse arm compl.		990096 990064
2	518052	rinse arm spindle		325051
3	518043	wash arm support	35f, 35fd,	429049
4	518058	O-ring	35 electronic, 350f, 350fd	456052
5	518056	support		115071
5	518427	support		115087



Item	Order	Description	Model	OEM
1	518426	wash and rinse arm compl.	E35, E35H	990096
2	518172	rinse arm spindle		325064
3	518173	wash arm support	E35 to Nr.295367	115106
4	518174	wash arm support	E35 ab Nr.295368	115110
5	518180	disc	E35H	303018



Item	Order	Description	Model	OEM
1	518040	wash and rinse arm compl.		990079
2	518428	wash arm right		106095
3	518429	wash arm left		106096
4	518430	rinse arm right	35f, 35fd,	106098
5	518431	rinse arm left	35 electronic, 350f, 350fd	106097
6	510138	wash jet		140020 140013
7	510131	union nut wash jet		429007
8	510139	rinse jet		140007
9	510130	union nut rinse jet		429006



Item	Order	Description	Model	OEM
1	518341	O-ring rinse arm spindle		456009
2	518340	throttle disc		199048 199052
3	518175	O-ring	E35, E35H	456061
4	518176	rinse arm		478056
5	518177	manifold		111023



Item	Order	Description	Model	OEM
1	518040	wash and rinse arm compl.		990079
2	518428	wash arm right		106095
3	518429	wash arm left		106096
4	518430	rinse arm right		106098
5	518431	rinse arm left	E35, E35H	106097
6	510138	wash jet		140020 140013
7	510131	union nut wash jet		429007
8	510139	rinse jet		140007
9	510130	union nut rinse jet		429006



Item	Order	Description	Model	OEM
1	518051	nut		429051
2	518058	O-ring	40f, 40fd,	456052
3	518056	support	40f electronic,	115071
4	518427	support	400f, 400fd	115087



Item	Order	Description	Model	OEM
1	510118	rinse arm compl.		993031
2	518443	rinse arm connector	E35, E35H	468165
3	518240	gasket		437062
4	518434	nut		429050



Item	Order	Description	Model	OEM
1	510010	wash arm cross		129003 129039
2	518382	wash arm right		106009
3	518385	wash arm left		106012
4	518384	rinse arm right	40f, 40fd,	106011
5	518383	rinse arm left	40f electronic,	106010
6	510138	wash jet	400f, 400fd	140013 140020
7	510131	union nut wash jet		429007
8	510139	rinse jet		140007
9	510130	union nut rinse jet		429006

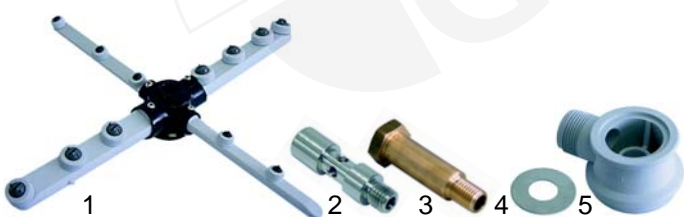

Item	Order	Description	Model	OEM
1	518001	wash and rinse arm compl.		990046
2	510108	rinse arm spindle	40f, 40fd,	327006
3	518048	rinse arm	40f electronic,	325039
4	518049	throttle disc	400f, 400fd	199034
5	518050	wash arm support		115073



Item	Order	Description	Model	OEM
1	510118	rinse arm compl.		993031
2	518443	rinse arm connector	40f, 40fd,	468165
3	518240	gasket	40f electronic,	437062 437078
4	518434	nut		429050



Item	Order	Description	Model	OEM
1	518437	wash and rinse arm compl.	E40, E40H	990104 990094
2	518172	rinse arm spindle		325064
3	518173	wash arm support	E40 to Nr.292118	115106
4	518174	wash arm support	E40 ab Nr.292119,	115110
5	518180	disc	E40H	303018



Item	Order	Description	Model	OEM
1	518312	wash arm fixed		990095PL
2	510118	rinse arm		993031
3	518443	rinse arm connector		468165
4	518240	gasket	E40, E40H	437078
5	518434	nut		429050
6	510146	wash jet		119003
7	510144	union nut wash jet		140010
8	510135	wash jet holder		110001



Item	Order	Description	Model	OEM
1	518341	O-ring rinse arm		456009
2	518340	throttle disc		199052 199047
3	518175	O-ring	E40, E40H	456061
4	518176	rinse arm		478056
5	518177	manifold		111023



Item	Order	Description	Model	OEM
1	518001	wash and rinse arm compl.		990046
2	510108	rinse arm spindle		327006
3	510058	throttle disc	E41, E42	199018
4	518445	wash arm support		115107

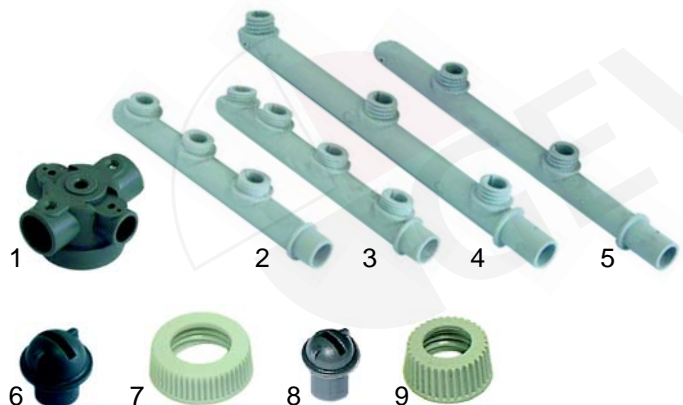

Item	Order	Description	Model	OEM
1	518438	wash arm cross		129050
2	518439	wash arm type A		106111
3	518440	wash arm type B		106112
4	518441	rinse arm type A		106113
5	518442	rinse arm type B	E40, E40H	106114
6	510138	wash jet		140020
7	510131	union nut wash jet		429007
8	510139	rinse jet		140007
9	510130	union nut rinse jet		429006



Item	Order	Description	Model	OEM
1	510054	gasket		437046
2	518446	O-ring (rinse arm)		456051
3	510056	rinse arm	E41, E42	325025
4	518447	support		111025

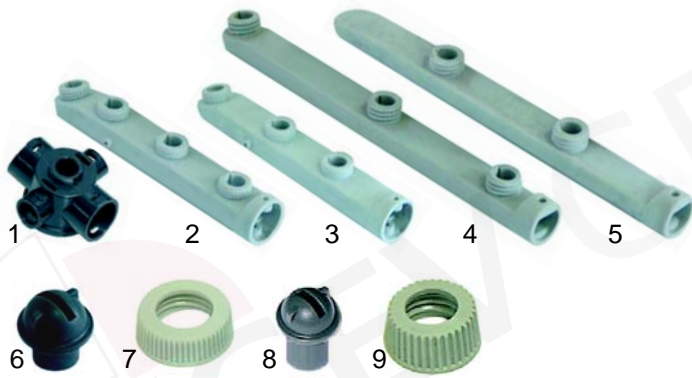

Item	Order	Description	Model	OEM
1	510010	wash arm cross	E41, E42	129003
2	518382	wash arm right		106009
3	518385	wash arm left		106012
4	518384	rinse arm right		106011
5	518383	rinse arm left		106010
6	510138	wash jet		140013 140020
7	510131	union nut wash jet		429007
8	510139	rinse jet		140007
9	510130	union nut rinse jet		429006



Item	Order	Description	Model	OEM
1	518025	gasket	E45	437014
2	518150	cuff		441009
3	518151	rinse arm		143199
4	513102	support		926052



Item	Order	Description	Model	OEM
1	510010	wash arm cross	E45	129003 129039
2	518382	wash arm right		106009
3	518450	wash arm left		106106
4	518451	rinse arm right		106107
5	518452	rinse arm left		106108
6	510138	wash jet		140020 140013
7	510131	union nut wash jet		429007
8	510139	rinse jet		140007
9	510130	union nut rinse jet		429006



Item	Order	Description	Model	OEM
1	518448	wash arm fixed	E41, E42	990099
2	510118	rinse arm		993031
3	518443	rinse arm connector		468165
4	518240	gasket		437078
5	518434	nut		429050
6	510146	wash jet		119003
7	510144	union nut wash jet		140010
8	510135	wash jet holder		110001
9	518444	wash arm end cap		480008



Item	Order	Description	Model	OEM
1	518453	wash arm fixed	E45	990092
2	510118	rinse arm compl.		993031
3	510146	wash jet		119003
4	510144	union nut wash jet		140010
5	510135	wash jet holder		110001
6	518410	wash arm end cap		441010



Item	Order	Description	Model	OEM
1	518449	wash and rinse arm compl.	E45	990097
2	510108	rinse arm spindle		327006
3	518049	throttle disc		199034
4	518168	wash arm support		115094



Item	Order	Description	Model	OEM
1	518449	wash and rinse arm compl. lower	E46	990097
2	518405	rinse arm spindle		325045
3	518337	throttle disc		199039
4	518024	wash arm column		115076



Item	Order	Description	Model	OEM
1	518025	gasket	E46	437014
2	518150	cuff		441009
3	518170	rinse arm		143174
4	518171	support		111019



Item	Order	Description	Model	OEM
1	510010	wash arm cross	E46	129039
2	518382	wash arm right		106009
3	518450	wash arm left		106106
4	518451	rinse arm right		106107
5	518452	rinse arm left		106108
6	510138	wash jet		140020 140013
7	510131	union nut wash jet		429007
8	510139	rinse jet		140007
9	510130	union nut rinse jet		429006



Item	Order	Description	Model	OEM
1	518020	rinse arm compl. lower	E50, E51	993037
2	510139	rinse jet		140007
3	510130	union nut rinse jet		429006
4	511149	rinse jet holder right		468124
5	511150	rinse jet holder left		468125
6	510113	clip		449029
7	518035	end cap		145004
8	510159	end cap with jet		145003



Item	Order	Description	Model	OEM
1	518455	wash arm lower	E50, E51	990087
2	518456	rinse arm spindle		325063
3	511143	bearing ring		303009
4	518457	rinse arm		325060
5	518458	throttle disc		199045
6	518459	throttle disc		199043



Item	Order	Description	Model	OEM
1	518031	wash arm support	E50, E51	115075
2	518025	gasket		437014
3	518150	cuff		441009
4	518170	rinse arm		143174
5	518171	support		111019

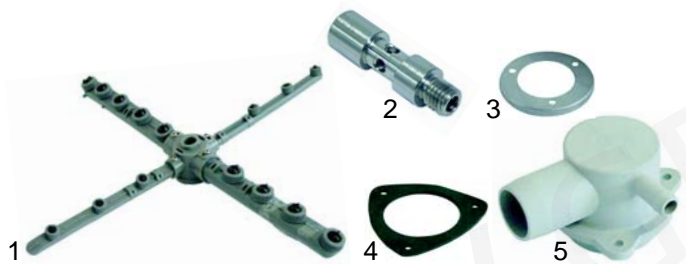

Item	Order	Description	Model	OEM
1	518269	wash and rinse arm compl. upper		990090 990108
2	510108	rinse arm spindle	E50, E51	327006
3	518461	bearing ring		303029
4	518339	gasket		437064
5	518338	wash arm support		115074



Item	Order	Description	Model	OEM
1	510010	wash arm cross		129003
2	518462	wash arm right		106102
3	518463	wash arm left		106103
4	518334	rinse arm right		106073CR 106007
5	518335	rinse arm left	E50, E51	106072CR 106005
6	518004	wash jet		140008
7	510131	union nut wash jet		429007
8	510139	rinse jet		140007
9	510130	union nut rinse jet		429006
10	511149	rinse jet holder right		468124
11	511150	rinse jet holder left		468125
12	510113	spring		449029

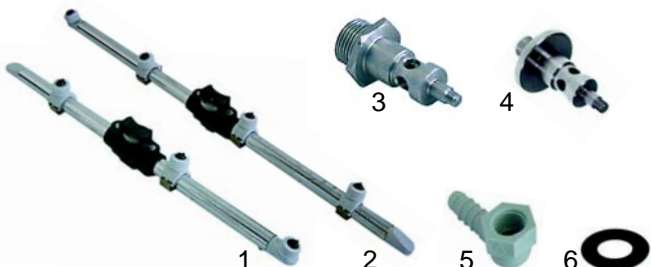

Item	Order	Description	Model	OEM
1	518022	rinse arm upper		993038
2	518020	rinse arm lower		993037
3	518034	rinse arm spindle upper	E52	325031
4	518456	rinse arm spindle lower		325063
5	518443	rinse arm connector upper		468165
6	518240	gasket		437078



Item	Order	Description	Model	OEM
1	510139	rinse jet		140007
2	510130	union nut rinse jet		429006
3	511149	rinse jet holder right	E52	468124
4	511150	rinse jet holder left		468125
5	510113	clip		449029



Item	Order	Description	Model	OEM
1	518455	wash arm		990087
2	511143	bearing ring		303009
3	518457	rinse arm	E52	325060
4	518458	throttle disc		199045
5	518459	throttle disc		199043
6	518031	wash arm column		115075



Item	Order	Description	Model	OEM
1	518025	gasket		437014
2	518150	cuff	E52	441009
3	518170	rinse arm		143174
4	518171	support		111019

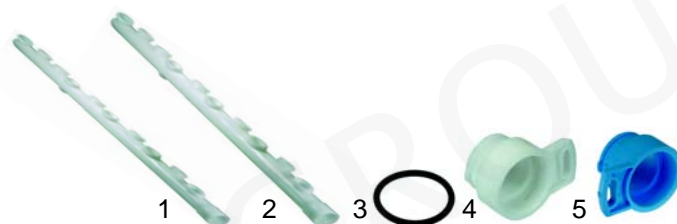

Item	Order	Description	Model	OEM
1	518466	wash arm fixed right		106044FR
2	518467	wash arm fixed left		106043FR
3	518398	O-ring	E52	456046
4	518468	coupling right		127030FR
5	518469	coupling left		127051



Item	Order	Description	Model	OEM
1	518401	angle connector	E52	108007
2	518402	gasket		437050
3	518403	wash arm support		127028
4	518039	wash arm end cap		480045
5	510147	wash jet		119004
6	510007	union nut wash jet		140014



Item	Order	Description	Model	OEM
1	513055	rinse jet	E65	926133
2	518416	rinse jet clamp		926131
3	518418	O-ring		456030
4	513122	end cap		926130
5	513152	rinse jet	E120, E140, 14	926061
6	518038	gasket		926058
7	518037	end cap		926062



Item	Order	Description	Model	OEM
1	518020	rinse arm compl.	E60, E100, E110, E120, Clean100, 10, 12, 66	993037
2	518470	rinse arm compl.	E65	929126
3	513148	rinse arm compl.	E120, E140, 14	926057



Item	Order	Description	Model	OEM
1	518455	wash arm	E60, E65, E100, E110, E120, E140, Clean100	990087
2	511143	bearing ring	10, 12, 14, 66	303009
3	518019	wash arm		990055
4	511144	nut	10, 12, 14	429030
5	511143	bearing ring		303009
6	511142	wash arm support	66	478037
7	511151	wash arm support		478040



Item	Order	Description	Model	OEM
1	513122	rinse arm spindle	E60, E65, E110, E120, E140, Clean100 (upper), E100 (upper)	926130
2	518420	rinse arm spindle	Clean100 (lower), E100 (lower)	926154
3	511141	rinse arm spindle upper	10, 12, 14	926037
4	518023	rinse arm spindle lower	10	926038
5	518014	rinse arm spindle	12, 14 (lower), 66	325011



Item	Order	Description	Model	OEM
1	518420	rinse arm	E60, E65, E100, E110, E120, Clean100	926154
2	518458	throttle disc	E110, E120, Clean100	199045
3	518459	throttle disc		199043
4	518026	wash arm support-extension	E60, E65, E100, E110, Clean100	926030
5	513129	rinse arm extension		926155



Item	Order	Description	Model	OEM
1	510139	rinse jet	E60, E100, E110, E120, Clean100, 10, 12, 66	140007
2	510130	union screw rinse jet		429006
3	511149	rinse jet holder right		468124
4	511150	rinse jet holder left		468125
5	510113	spring		449029
6	518035	end cap		145004
7	510159	end cap with jet		145003



Item	Order	Description	Model	OEM
1	518024	wash arm column lower	E60, E65, E100, E110, Clean100	115076
2	518031	wash arm support lower	E120, E140	115075
3	518025	gasket		437014





Item	Order	Description	Model	OEM
1	518150	cuff	E60, E65, E100	441009
2	513131	rinse arm	E110, Clean100, 10	926031
3	518171	support lower		111019
4	518471	rinse arm	E120, E140, 12, 14	926065
5	513102	support lower		926052



Item	Order	Description	Model	OEM
1	518476	gasket	E100, E110,	929061
2	513229	support	E120, E140,	926036
3	513228	gasket	Clean100, 10, 12, 14	926035



Item	Order	Description	Model	OEM
1	518059	wash arm column lower		115041
2	518472	wash arm support upper	66	115042
3	518008	gasket		437016



Item	Order	Description	Model	OEM
1	518477	rinse arm compl.	U61, U61H	C41175
2	518478	rinse arm compl.	U70, U132	C422051
3	513122	rinse arm spindle		926130



Item	Order	Description	Model	OEM
1	513226	rinse arm upper		929117
2	518473	disc	E45, E66	927084
3	518474	support		929116
4	518339	gasket		437064
5	518338	wash arm support		115074



Item	Order	Description	Model	OEM
1	513055	rinse jet		926133
2	518416	rinse jet clamp	U61, U61H,	926131
3	518418	O-ring	U70, U132	456030
4	518419	end cap		926132



Item	Order	Description	Model	OEM
1	513224	rinse arm	E100, E110,	926127
2	518475	wash arm support upper	E120, E140, Clean100	926153
3	518030	wash arm support upper		926029



Item	Order	Description	Model	OEM
1	513144	wash arm upper	U61	926126 926248
2	n. l. a.	wash arm	U61, U61H	929195
2	518481	wash arm	U70, U132	929196

Suitable for Electrobar/Wolk



Item	Order	Description	Model	OEM
1	513226	rinse arm		929117
2	513225	holder upper	U61	929194
3	518339	gasket		437064
4	518338	support upper		115074



Item	Order	Description	Model	OEM
1	518018	wash jet holder		110004
2	510147	wash jet		119004
3	510007	union nut wash jet		140014



Item	Order	Description	Model	OEM
1	518018	wash jet holder		110004
2	510148	wash jet		119002
3	510143	union nut wash jet		140003
4	518018	wash jet holder		110004
5	510147	wash jet		119004
6	518482	union nut wash jet		140012



Item	Order	Description	Model	OEM
1	510113	clip		449029
2	510134	rinse jet holder		468055
3	510137	rinse jet		138001
4	510140	union nut rinse jet		140006
5	510132	rinse jet holder		110002
6	510137	rinse jet		138001
7	510140	union nut rinse jet		140006



Item	Order	Description	Model	OEM
1	518159	wash jet holder		110010
2	510146	wash jet		119003
3	510144	union nut wash jet		140010
4	510135	wash jet holder		110001
5	510146	wash jet		119003
6	510144	union nut wash jet		140010



Item	Order	Description	Model	OEM
1	510113	clip		449029
2	511149	rinse jet holder right		468124
3	511150	rinse jet holder left		468125
4	510139	rinse jet		140007
5	510130	union nut rinse jet		429006



Item	Order	Description	Model	OEM
1	518044	wash jet holder		110003
2	518004	wash jet		140008
3	510131	union nut wash jet		429007
4	518044	wash jet holder		110003
5	510138	wash jet		140013 140020
6	510131	union nut wash jet		429007



Item	Order	Description	Model	OEM
1	518164	rinse jet	Clean 3	140019
2	518391	end cap		480065
3	513152	rinse jet		926061
4	518038	O-ring	E140, 14	926058
5	518037	end cap		926062

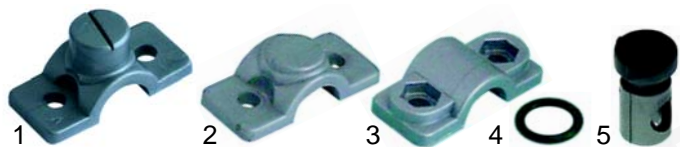

Item	Order	Description	Model	OEM
1	513055	rinse jet		926133
2	518417	blind jet		926168
3	518416	rinse jet clamp	050F, 050FP, F85, F85P	926131
4	518418	O-ring		456030
5	518419	end cap		926132



Item	Order	Description	Model	OEM
1	510138	wash jet		140020 140013
2	510131	union nut wash jet		429007
3	518004	wash jet		140008
4	510131	union nut wash jet		429007
5	510139	rinse jet		140007
6	510130	union nut rinse jet		429006



Item	Order	Description	Model	OEM
1	518046	rinse jet holder		110006
2	510139	rinse jet		140007
3	510130	union nut rinse jet		429006



Item	Order	Description	Model	OEM
1	518035	end cap rinse arm		145004
2	510159	end cap for rinse jet		145003
3	510112	lock screw		454002
4	518003	cap lock screw		447030 447128
5	518028	lock screw		454004
6	518027	protection lock screw		412023



Item	Order	Description	Model	OEM
1	518483	wash arm clip		449041
2	518484	wash arm clip		449045
3	518485	spacer piece		419030

## Various



Item	Order	Description	Model	OEM
1	518238	divider		143173
2	518347	T-fitting		468149
3	541109	Y-piece pressure switch		035031



Item	Order	Description	Model	OEM
1	518297	back flow restrictor		144011 144004
2	518486	back flow restrictor		144010

## Air traps



Item	Order	Description	Model	OEM
1	510103	air trap compl.		984001
2	518487	air trap		107002
3	510105	connection fitting		468053
4	510077	O-ring		456006
5	510016	banjo bolt		486002



Item	Order	Description	Model	OEM
1	518200	air trap compl.		984005
2	510075	gasket		437019
2	510075	gasket		437019
3	518488	air trap		107005
4	518227	gasket		456020
5	361270	chemical feed elbow		468024 / 468151

## Detergent systems

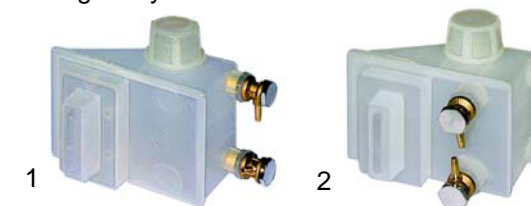

Item	Order	Description	Model	OEM
1	510100	container compl., connection on the side	S621-S830, 21, 25, 30, 31	999041
2	510099	container compl., connection in the front		999016



Item	Order	Description	Model	OEM
1	510077	O-ring		456006
2	510105	connection fitting		468053
3	510016	banjo bolt		486002
4	510014	gasket		437036

Suitable for Electrobar/Wolk



Item	Order	Description	Model	OEM
1	510107	rinse mixer		991001
2	518348	injector		468117
3	518541	gasket		437021
4	518370	injector		468114

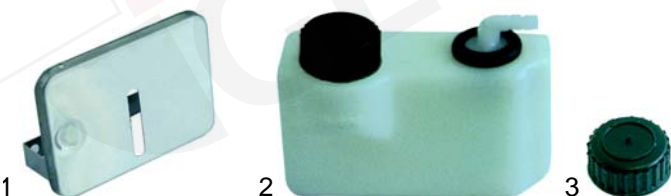

Item	Order	Description	Model	OEM
1	518542	access plate		029096
2	518072	container	Clean 3, 11f, E41, E42	114995
3	518073	container lid		480023

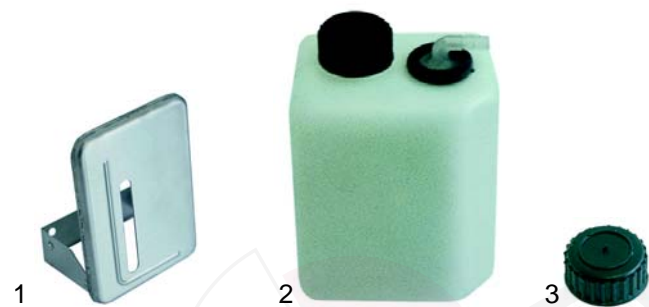

Item	Order	Description	Model	OEM
1	518543	access plate	44f, 440f, 22f, 40f, E52	029032
2	510019	container		114997
3	518073	container lid		480023



Item	Order	Description	Model	OEM
1	361270	chemical feed elbow		999104
2	513043	container filter		121017



Item	Order	Description	Model	OEM
1	518544	suction tube		986006

## Softeners



Item	Order	Description	Model	OEM
1	510109	cap		480006
2	510071	gasket		437034
3	510110	nut		429012

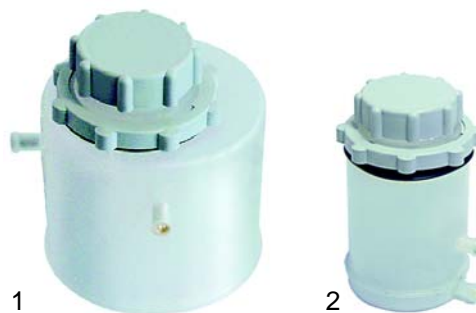

Item	Order	Description	Model	OEM
1	510929	salt container compl.		406999
2	510032	salt container compl.		406998



Item	Order	Description	Model	OEM
1	510015	cap		480005
2	510072	gasket		456016
3	510018	nut		429011
4	510071	gasket		437034

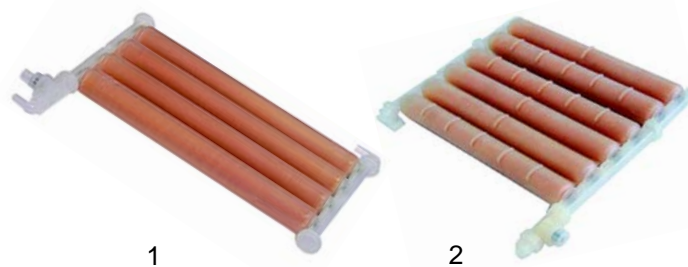

Item	Order	Description	Model	OEM
1	530000	softener/ 4 columns		117001
2	518545	softener/ 6 columns		117002



Item	Order	Description	Model	OEM
1	518296	softener/ 6 columns		117003
2	518233	softener/ 4 columns		117004

## Drain and filter systems



Item	Order	Description	Model	OEM
1	510045	filter group compl.	S621, S623, S624, S626, S631, S633, S634, S636,	986001
2	510038	drain plug	21f, fd, v, vd,	142008
3	518490	drain plug drain pump	25f, fd, v, vd, 30f, fd, v, vd,	142018
4	518491	O-ring	31f, fd, v, vd	456010

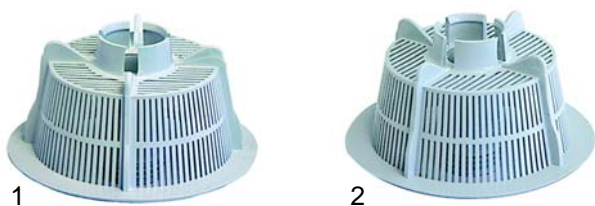

Item	Order	Description	Model	OEM
1	510040	outer filter	S621, S623, S624, S626, S631, S633, S634, S636,	121014
2	510041	inner filter	21f, fd, v, vd, 25f, fd, v, vd, 30f, fd, v, vd, 31f, fd, v, vd	121016



Item	Order	Description	Model	OEM
1	518199	filter location	S621, S623, S624, S626, S631, S633, S634, S636,	429013
2	510009	O-ring	21f, fd, v, vd, 25f, fd, v, vd,	456001
3	518201	sump	30f, fd, v, vd, 31f, fd, v, vd	136002



Item	Order	Description	Model	OEM
1	510020	drain plug	22f, 44f, 440f,	142022
2	510021	drain plug (drain pump)	E52, E60, E65,	142028
3	510072	O-ring	Clean100, 10,	456016
4	510022	outer filter	E100, E110	121052

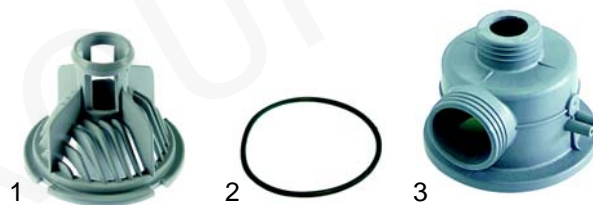

Item	Order	Description	Model	OEM
1	518065	inner filter	22f, 44f, 440f,	429038
2	518060	O-ring	E52, E60, E65,	456040
3	518064	sump	Clean100, 10, E100, E110	136020

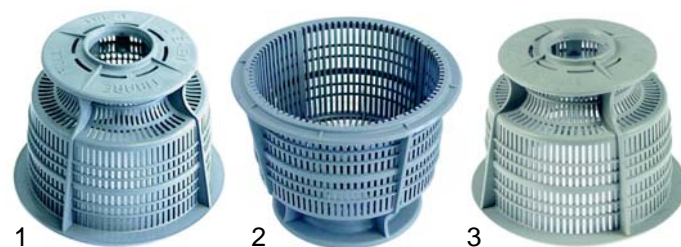

Item	Order	Description	Model	OEM
1	518154	drain filter	45, 450, 46, 460	121077
2	518207	drain filter	050F, 050FP, F85, F85P	121081
3	510022	drain filter	50f/fd, 500f/fd, E45, E46, E50, E51	121052



Item	Order	Description	Model	OEM
1	518074	filter location	45, 450, 46, 460, 050F, 050FP, F85, F85P, 50f/fd, 500f/fd,	478059 478045+ 478046
2	518210	gasket	E45, E46, E50, E51	437015



Item	Order	Description	Model	OEM
1	513181	drain plug		C41180
2	510072	O-ring	U61, U61H	456016
3	518207	drain filter		121081

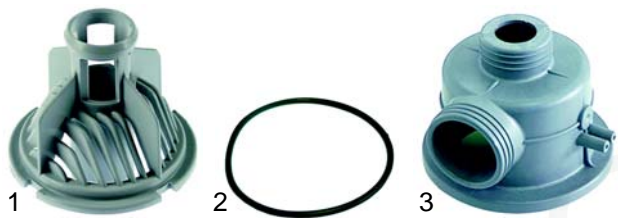

Item	Order	Description	Model	OEM
1	518065	filter location	U61, U61H	429038
2	518060	O-ring		456010
3	518064	sump		136020



Item	Order	Description	Model	OEM
1	510042	filter	E4, E42, 11f/ fd/ v/ vd	121076 121047



Item	Order	Description	Model	OEM
1	518494	drain connection	11f/ fd/ v/ vd, E4, E42	468103
2	510080	gasket		437027
3	510072	O-ring		456016

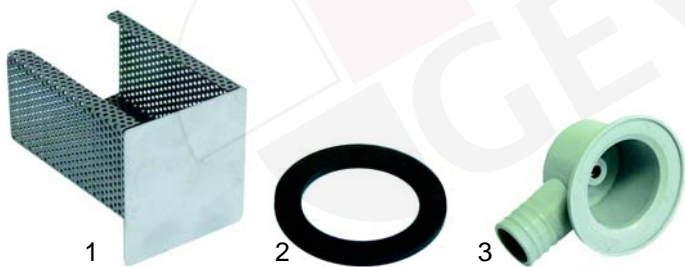

Item	Order	Description	Model	OEM
1	518350	filter	35 f/ fd/ v/ vd,	121064
2	510070	gasket	40 f/ fd/ v/ vd,	437038
3	510044	drain connection	350 f/ fd/ v/ vd, 400 f/ fd/ v/ vd	663004 463004



Item	Order	Description	Model	OEM
1	518202	drain plug	E35, E35H, E40, E40H	142051
2	518203	drain filter		121100
3	518204	nut		429065



Item	Order	Description	Model	OEM
1	518205	gasket	E35, E35H, E40,	437079
2	518177	manifold	E40H	111023

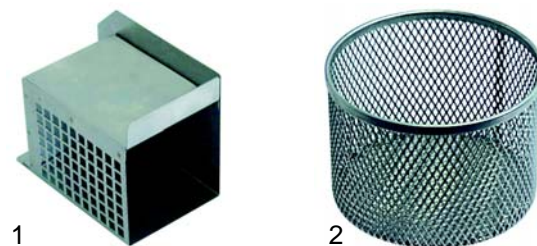

Item	Order	Description	Model	OEM
1	518496	filter	12, 14, E120, E140	926051
2	510065	filter	66	121011



Item	Order	Description	Model	OEM
1	n. l. a.	drain system compl.	S651-S656 (old)	999020
2	n. l. a.	drain system compl.	S651-S654, S810- S835 (new)	999063
3	510101	drain system compl.	11f/ fd/ v/ vd	999067



Item	Order	Description	Model	OEM
1	510023	drain plug	S651-S656 (old)	142011
2	n. l. a.	drain plug	S651-S654 (new), S810-S835 (new)	142013
3	518500	drain seating		142001
4	510070	gasket	S651-S656, S810-S835	437038
5	518501	gasket		437033

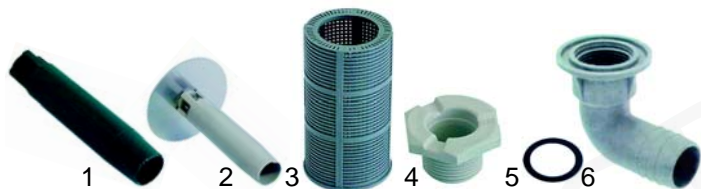

Item	Order	Description	Model	OEM
1	510027	drain plug	11fd, E41, E42	142014
2	518502	drain plug drain pump		142037
3	518351	filter drain pump	E41, E42	121070
4	518187	drain seating	11f/ fd/ v/ vd, E41, E42	429048 429036
5	510074	O-ring		437025
6	518503	drain elbow		463008



Item	Order	Description	Model	OEM
1	518194	drain elbow	45, 450, 46, 460, 50f/ fd, 500f/ fd, 510fd, 050F,	136023
2	513059	O-ring	050FP, F85, F85FP,	437063
3	513103	nut	E45, E46, E50, E51	417081



Item	Order	Description	Model	OEM
1	518186	drain plug	35, 350 f/ fd/ v/ vd	142038
2	518055	drain plug	40, 400 f/ fd/ v/ vd	142034
3	518065	filter location		429038
4	510074	O-ring	35, 350 f/ fd/ v/ vd, 40, 400 f/ fd/ v/ vd	437025 456016
5	510072	O-ring		456016
6	518190	drain elbow		463009

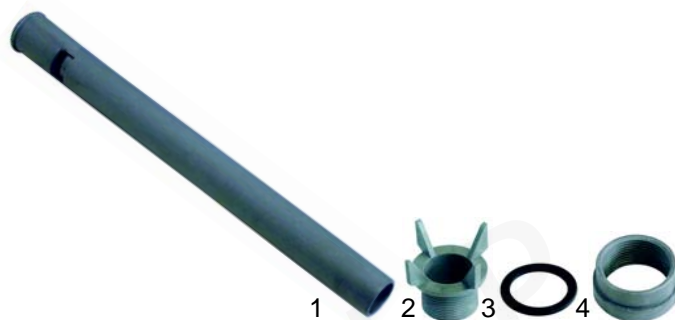

Item	Order	Description	Model	OEM
1	513240	drain plug		926046
2	513176	drain seating	12, 14, E120, E140	929036
3	513059	O-ring		437063
4	513177	hose connector		926050



Item	Order	Description	Model	OEM
1	518193	drain plug	45, 450, 46, 460, 50f/ fd, 500f/ fd, 510fd	142035 142052
2	518290	drain plug drain pump		142042
3	518351	filter drain pump		121070



Item	Order	Description	Model	OEM
1	518505	drain plug drain pump		926109
2	518506	filter drain pump		926207
3	518308	O-ring		303019
4	518507	drain seating	E120, E140	926208
5	513059	O-ring		437063
6	518508	nut		926222



Item	Order	Description	Model	OEM
1	518193	drain plug	050F, 050FP, F85, F85FP, E45, E46, E50, E51	142052 142035 142053
2	518191	drain plug drain pump		142053
3	518192	filter drain pump		121078

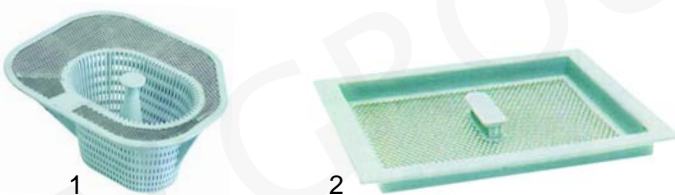

Item	Order	Description	Model	OEM
1	510142	wash tank filter compl.	Clean 3	121072
2	n. l. a.	flat filter	S651-S654, S810- S835, 66	121023

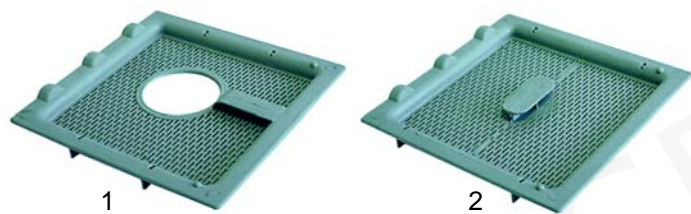

Item	Order	Description	Model	OEM
1	510026	flat filter	22f, 22r, 40f, E52,	121057
2	510025	flat filter	Clean100, 10, E100	121056

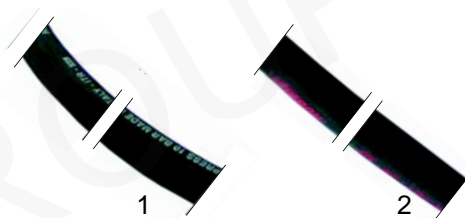

Item	Order	Description	Model	OEM
1	518214	inlet hose	35, 350, 40, 400	143006
2	518213	outlet hose		143009



Item	Order	Description	Model	OEM
1	518217	inlet hose	S621-S636, 21.31, 25.30	127013
2	518216	outlet hose	S621-S636	127001
3	518036	outlet hose	21.31, 25.30	127012



Item	Order	Description	Model	OEM
1	513135	inlet hose	E60, E65, 12, 14	926056
2	513134	outlet hose		926034



Item	Order	Description	Model	OEM
1	518295	inlet hose	S651-S656 (to Nr.80211), S830-S835 (to Nr.80211), 50f, 500	127003
2	510024	outlet hose	S651-S656 (to Nr.80211), S830-S835 (to Nr.80211)	127002
3	518510	outlet hose	50f, 500	143008



Item	Order	Description	Model	OEM
1	513244	inlet hose	Clean100, 10, E100, E110	926033
2	513134	outlet hose		926034

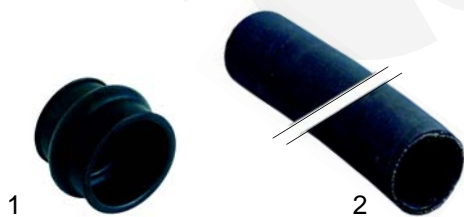

Item	Order	Description	Model	OEM
1	518511	inlet hose	S651-S654 (from Nr.80212), S810-S835 (from Nr.80212)	127016
2	518512	outlet hose		143008

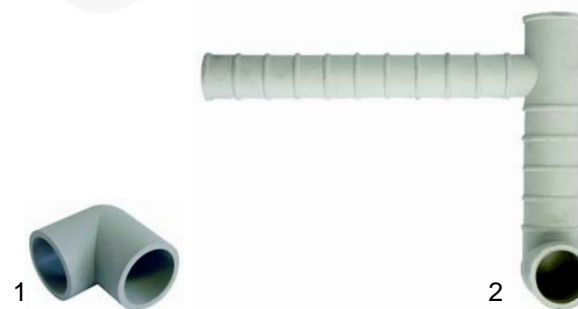

Item	Order	Description	Model	OEM
1	513135	inlet hose	E120, E140	926056
2	513247	outlet hose		926158



Item	Order	Description	Model	OEM
1	518218	outlet hose	Clean3	127038



## Drain pump hoses

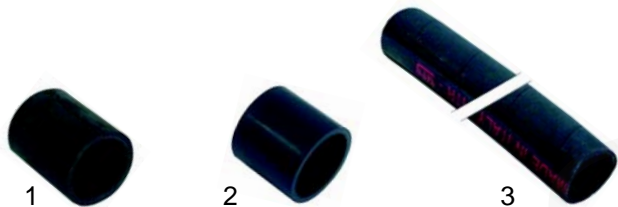

Item	Order	Description	Model	OEM
1	518380	outlet hose upper	44, 440, E52	127036
2	518070	outlet hose upper	22f, 40f	127026
3	518513	outlet hose upper	44, 440, E52, 22f, 40f	143158



Item	Order	Description	Model	OEM
1	518515	inlet hose	44, 440, 22f, 40f E60, E65	127033
2	518213	inlet hose	45, 450, E45	143009



Item	Order	Description	Model	OEM
1	518380	inlet hose	50f, 500f, 510f, E46,	80189
2	518381	outlet hose	E50, E51, E60, E65	127035



Item	Order	Description	Model	OEM
1	518517	drain hose	46, 460, 050F, 050FP, E46, E50, E51, 50f, 500f, 500fd	127045 127050



Item	Order	Description	Model	OEM
1	513245	inlet hose	Clean100, E100,	926032
2	513246	outlet hose	E110	926157

no picture!



Item	Order	Description	Model	OEM
1	518518	inlet hose	50f, 500fd	143178
2	518519	inlet hose	E35, E35H, E40, E40H	127054

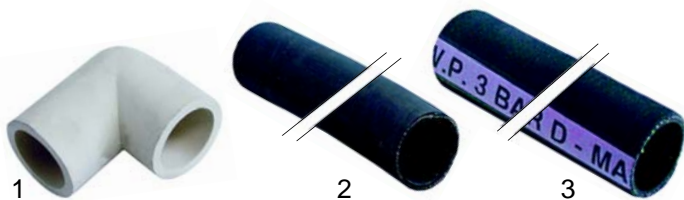

Item	Order	Description	Model	OEM
1	513245	outlet hose upper	10, 12, 14, E120, E140	926032
2	518512	outlet hose upper	10	143008
3	513249	outlet hose upper	12, 14	926069



Item	Order	Description	Model	OEM
1	518520	drain hose	E41, E42	127005

## F Door components

Suitable for Electrobar/Wolk

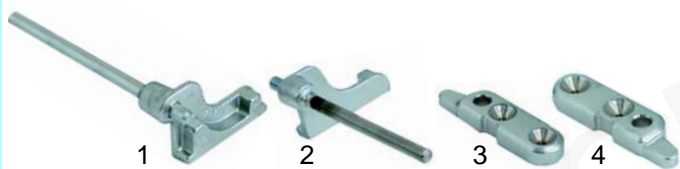

Item	Order	Description	Model	OEM
1	518253	hinge right	S621-S636,	311001CR
2	518547	hinge left	S651-S656,	311002CR
3	518256	hinge block right	S810-S835, 44,	307001CR
4	518257	hinge block left	440, 21, 25, 30, 31	307002CR



Item	Order	Description	Model	OEM
1	518550	hinge right		311006CR
2	518551	hinge left		311005CR
3	518552	hinge block right	11f, 22f, 40f, E41, E42, E52	307009
4	518553	hinge block left		307008
5	518554	hinge pin		325022
6	518555	hinge pin	E52	325033



Item	Order	Description	Model	OEM
1	518556	door pin		929018
2	518557	circlip	E60, E65	929017
3	518558	door stay		929016
4	518559	threaded shaft		929015
5	518560	circlip		929014

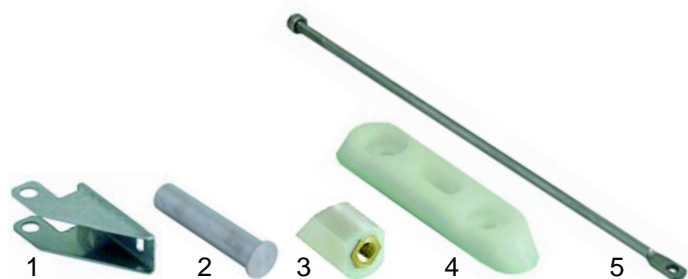

Item	Order	Description	Model	OEM
1	518301	hinge right/ left	45, 450, 46, 460, 050F, 050FP, F85,	311019 311010 311011
2	518267	hinge pin	F85P, 50f, 500f, 510f, E49, E46,	325036
3	518066	end stop	E50, E51	417041
4	518356	rod guide		307003
5	518355	door stay		304021



Item	Order	Description	Model	OEM
1	518261	hinge right	35, 350, E35, 40,	311008
2	518262	hinge left	450, E40	311009
3	518263	door pin	35, 350, E35	304017
4	518264	hinge pin		325034
5	518354	end stop	40, 450, E40	028078
6	518353	rod guide		307005

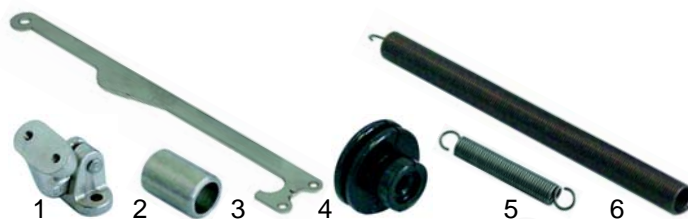

Item	Order	Description	Model	OEM
1	518522	hinge		311013
2	518259	bush		308026
3	518258	door spring guide	Clean 3	304020
4	518363	roller		499078
5	518523	spring		449048
6	518260	spring 130		449049



Item	Order	Description	Model	OEM
1	510068	catch	S621-S636, 21, 31, 25, 30	994001
2	510069	door catch		123002
3	n. l. a.	catch	S651	994008
4	510089	door catch		123011



Item	Order	Description	Model	OEM
1	518244	catch	44, 440f, 45, 450, 46, 460, 050F, F85, 22f,	994011 994012
2	518245	door catch	40f, 50f, 500f, 510f, E45, E46, E50, E51, E52, E60, E65	325030
3	510090	catch spring	11, 356, 350, 40, 400, E35, E41, E42	449036
4	510091	tongue	11	329009
5	518524	door stay	35, 40, 400, E35, E40, E41, E42	329012

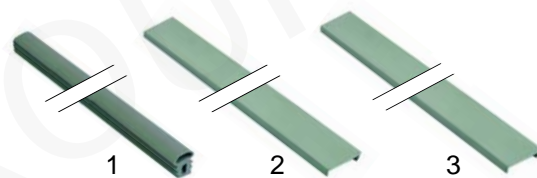

Item	Order	Description	Model	OEM
1	518252	door seal 1160 mm	Clean 3	437071
2	518299	door seal 570 mm	050F, 050FP	437081
3	518535	door seal 450 mm	11, E41, E42	437051

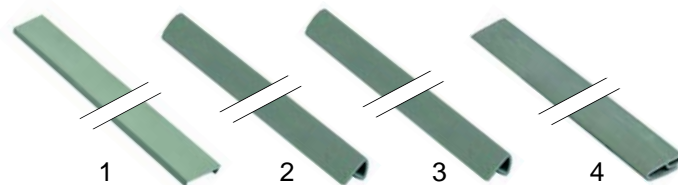

Item	Order	Description	Model	OEM
1	518536	door seal 590 mm	22f, 40, E52	437052
2	518246	door seal 395 mm	35f, 350f, E35	437057
3	518248	door seal 430 mm	40f, 400, E40	437058
4	518300	door seal 590 mm	E60, E65	437075



Item	Order	Description	Model	OEM
1	518525	door handle compl.	S621-S636	447036
2	510083	door handle compl.	S651-S830	447037

## Hood components



Item	Order	Description	Model	OEM
1	518537	joint support	Clean100, 10, 12,	926003
2	518538	plate support	14, E100, E110,	926002
3	518309	handle support	E120, E140	037043
4	518539	roller compl.		926006



Item	Order	Description	Model	OEM
1	518540	screw		927273
2	518561	bush inner	E100, E110, E120, E140	C36426
3	518562	bush outer		C36425



Item	Order	Description	Model	OEM
1	513205	spring holder old		926004
2	518563	spring holder new	Clean100, 10, 12, 14, E100, E110,	C36429
3	513119	spring compressor	E120, E140	926009
4	513206	spring		926007



Item	Order	Description	Model	OEM
1	518526	door handle recess	Clean 3	447137
2	518527	door handle recess	44f, 440, E60, E65, 21, 31, 25, 30	447116
3	518528	door handle		447117

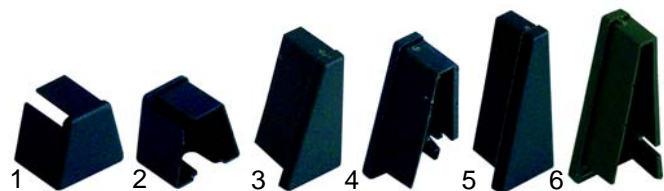

Item	Order	Description	Model	OEM
1	518529	door handle end cap right	45, 450, 46,	480042
2	518530	door handle end cap left	460	480043
3	518531	door handle end cap right	E35, E40, E41, E42, E45	480092
4	518532	door handle end cap left		480091
5	518533	door handle end cap right	E46, E50, E51, E52	480098
6	518534	door handle end cap left		480097

## Electrical components

Switches and lamps

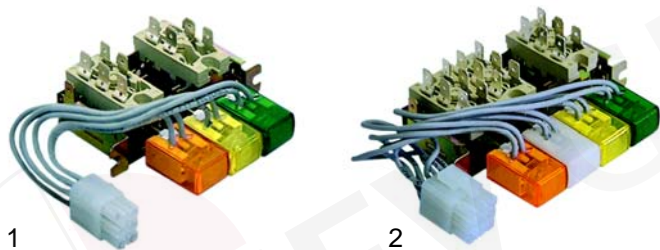

Item	Order	Description	Model	OEM
1	345005	switch combination	S621, S624, S631, S634, S651, S654, S810, S835, S830 (from No. 80212), S950 (to No. 81059), 21_, 31_, 25_, 35_	227002, 227014, 227011
2	345006	switch combination	S623, S626, S633, S636, SG1/P, SG53, SG55, S830 (to No. 80211), S850 (to No. 81936)	227003, 227015, 227012
2	345006	switch combination/ drain pump	S621, S624, S631, S634, S651, S654, S810, S835, 21_, 31_, 25_, 35_	227003, 227015, 227012

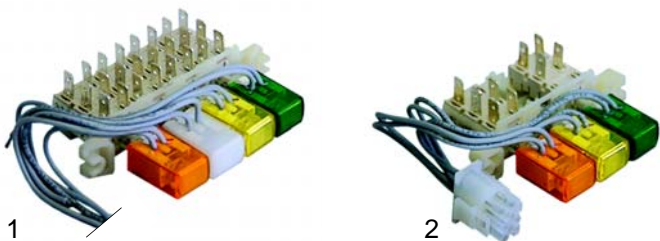

Item	Order	Description	Model	OEM
1	345514	switch combination	S850 (from No. 81937), S950 (from No. 81060), S870 (from No. 64903)	227001
2	345501	switch combination	44f, 440f	227016



Item	Order	Description	Model	OEM
1	345502	switch combination/ drain pump	44f, 440f	227017

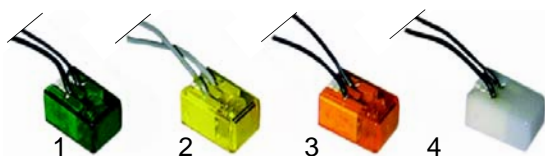

Item	Order	Description	Model	OEM
1	359001	signal lamp, green		226007
2	359002	signal lamp, yellow		226008
3	359003	signal lamp, orange		226005
4	359006	signal lamp, clear		226006

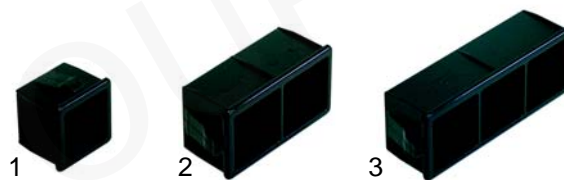

Item	Order	Description	Model	OEM
1	345604	switch housing, single	35/ 350_, 40/ 400_,	226072
2	345602	switch housing, double	45/ 450_, 46/ 460_,	226073
3	345603	switch housing, treble	50/ 500/ 510_	226074



Item	Order	Description	Model	OEM
1	345605	switch, 2-pole-changeover	35/ 350_, 40/ 400_, 45/ 450_,	208010
2	345606	push button, 2-pole-changeover	46/ 460_, 50/ 500/ 510_	226071
3	345608	indicator		409001



Item	Order	Description	Model	OEM
1	359130	signal element		216006
2	345601	signal lamp holder		299035
3	345614	button (heating)	35/ 350_, 40/ 400_, 45/ 450_, 46/ 460_,	410008
4	345610	button (cycle)	50/ 500/ 510_	207007
5	345612	button (blind)		480059



Item	Order	Description	Model	OEM
1	345607	push button (main switch)	35/ 350_,	227025
2	345609	push button (start)	40/ 400_,	227027
3	345611	push button (rinse)	45/ 450_,	227029
4	345615	push button (program)	46/ 460_,	227033
5	345613	push button (drain pump)	50/ 500/ 510_	227030



Item	Order	Description	Model	OEM
1	345657	housing, 36 x 28 (for switch)	E35, E35H, E40,	226099
2	345656	housing, 36 x 28 (for switch)	E40H, E41, E42,	226100
3	345654	housing, 36 x 28 (for switch + lamp)	E45, E46, E51, E52	226097



Item	Order	Description	Model	OEM
1	345655	housing, 36 x 28 (blind)	E35, E35H,	480096
2	345653	housing, 28 x 28 (lamp)	E40, E40H,	226098
3	345652	housing, 28 x 28 (blind)	E41, E42, E45, E46, E51, E52	480095

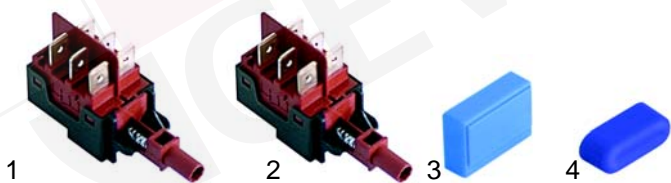

Item	Order	Description	Model	OEM
1	345651	switch, 2-pole-changeover		208011
2	345650	push button, 2-pole-changeover	E35, E35H, E40, E40H,	226095
3	345658	push button, large	E41, E42, E45,	227052
4	345659	push button, short	E46, E51, E52	227051



Item	Order	Description	Model	OEM
1	359005	lamp, yellow	E35, E35H, E40,	216025
2	359004	lamp, green	E40H, E41, E42, E45,	216028
3	359009	lamp, red	E46, E51, E52	216029



Item	Order	Description	Model	OEM
1	345657	housing, 36 x 28 (for switch)	E60, E65,	226099
2	345656	housing, 36 x 28 (for switch)	E100, E110,	226100
3	345654	housing, 36 x 28 (for switch + lamp)	E120, E140, U61, U61H, U70, U132	226097



Item	Order	Description	Model	OEM
1	345605	switch, 2-pole-changeover	E60, E65,	208010
2	345606	push button, 2-pole-changeover	E100, E110,	226071
3	345658	push button/ large	E120, E140, U61, U61H,	227052
4	345659	push button/ short	U70, U132	227051



Item	Order	Description	Model	OEM
1	359130	signal element, 230V	E60, E65, E100, E110,	926113
2	359127	socket, yellow	E120, E140, U61,	926115
3	359005	signal lamp, yellow	U61H, U70, U132	216025



Item	Order	Description	Model	OEM
1	345956	push button, 1-pole		226004
2	345957	push button, yellow	S850, S870 (from No. 64903)	299004
3	345958	lamp, 230V		216011



Item	Order	Description	Model	OEM
1	345002	switch, 2-pole-changeover		208008,2 08009
2	345003	switch, 2-pole	11f/ fd/ r/ rd (to No. 141000)	208006, 213007
3	345191	push button, 2 pole		226037, 226041



Item	Order	Description	Model	OEM
1	345001	push button, 1-pole/with sep. signal lamps connection		590070
2	345039	button cover	11f/ fd/ r/ rd (to No. 141000)	410005
3	359005	signal lamp, 230V		216003, 210005

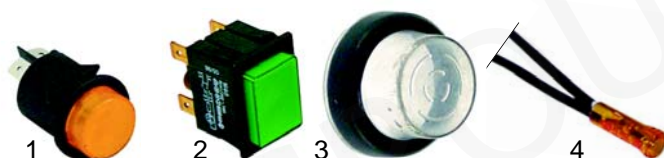

Item	Order	Description	Model	OEM
1	345962	push button, 1-pole (lamp separate)		999082
2	301047	switch, 2-pole	11f/ fd/ r/ rd,	226059
3	345039	button cover	ab No.	410005
4	359005	signal lamp	141001	216003, 216005

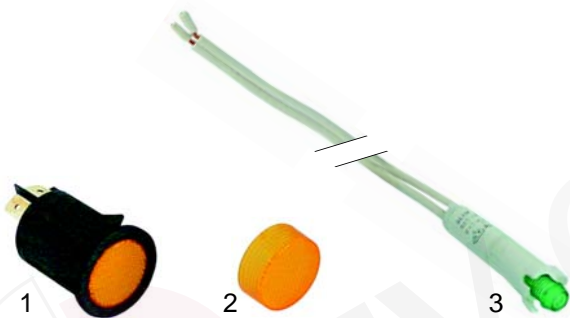

Item	Order	Description	Model	OEM
1	345961	pushbuttonn (lamp separate)		999107
2	345959	panel/ yellow	Clean 3	410009
3	345960	signal lamp		216022

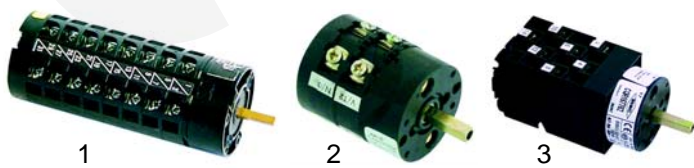

Item	Order	Description	Model	OEM
1	345503	rotary switch	Clean 3	205008
2	345020	rotary switch	22f/ r	213003
3	345203	rotary switch/ drain pump	22f/ r	205004

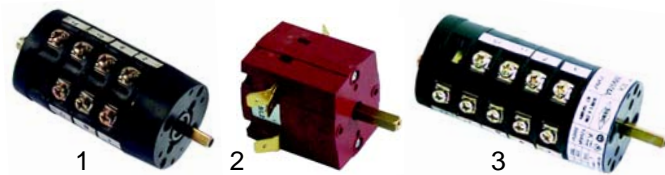

Item	Order	Description	Model	OEM
1	345916	rotary switch	E60, E65, E100, E110, E120, E140	926182
2	345113	rotary switch	Clean 100, S870 (to No. 64902), 10.12.66	213002
3	345506	rotary switch	14	926044



Item	Order	Description	Model	OEM
1	345628	rotary switch	U61, U61H, U70, U132	926186
2	110161	knob		447088, 999106, 447163, 447130, 447007, 447013

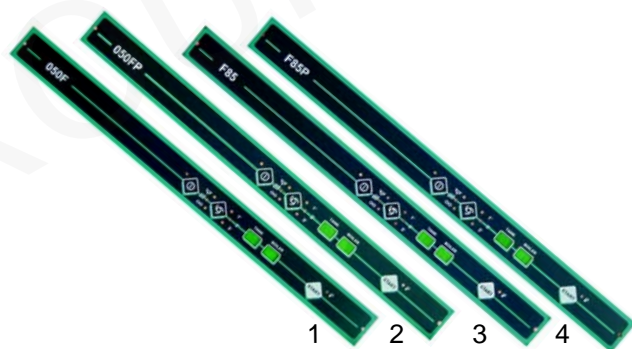

Item	Order	Description	Model	OEM
1	359042	signal lamp, 230V, yellow	22f/ r, 40f (DVGW), Clean	216018
2	359041	signal lamp, 230, green	100, 10, 12, 14, 66	216019
3	359044	signal lamp, 230V, clear		216020

**Electrical**

Item	Order	Description	Model	OEM
1	518565	fascia	050F	OL5470
2	518566	fascia	050FP	OL5471
3	518567	fascia	F85	OL5472
4	518568	fascia	F85P	OL5473

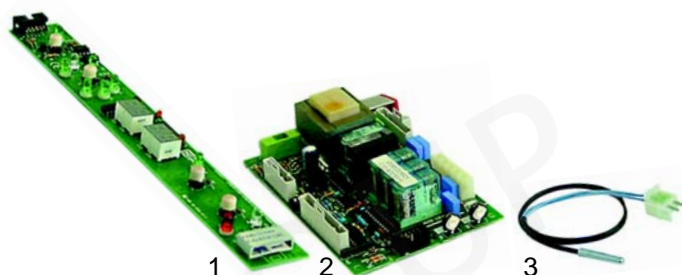

Item	Order	Description	Model	OEM
1	400897	display p.c.b.		227059
2	400899	main p.c.b.	050F, 050FD, F85, F85D	215023
3	400910	temperature sensor		231014

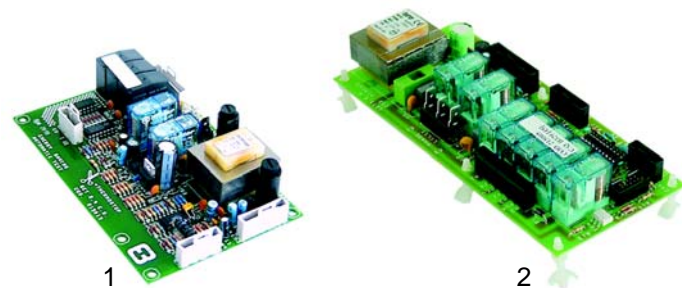

Item	Order	Description	Model	OEM
1	400157	control p.c.b.	45, 46, 35f, 40f, 50f	215013, 215009
2	400948	control p.c.b.	44f, 51f	215005

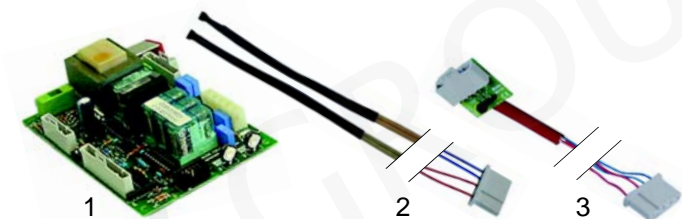

Item	Order	Description	Model	OEM
1	400899	control p.c.b.	E35H, E40H	215018
2	379101	temperature sensor	35f, 40f, 50f, 46f, 44f,	231006
3	379905	extension	51f, 45f, E35H, E40H	231008

## Timers

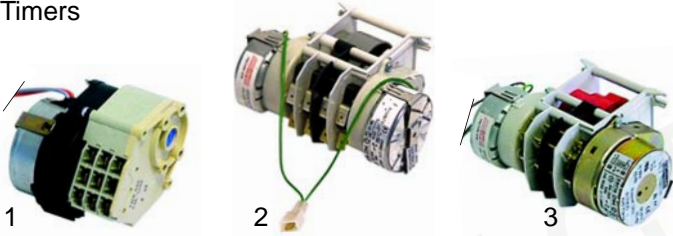

Item	Order	Description	Model	OEM
1	360003	150°, 3 cams	S621, S623, S624, S626, S631, S633, S634, S636, S651, S653, S654, S655, 11_, 21_, 25_, 30_, 31_, 350_, 400_, 450_, E35, E40, E41, E42, E45	238046AG, 238012, 238026, 238007, 238033, 238036, 238041, 238042, 238053
2	360004	108°/ 168°, 4 cams	S651/ P, S810, S815, S830, S835	238003
3	360136	60/ 120/180°, 4 cams	S850, S870 (from No. 64903)	238002

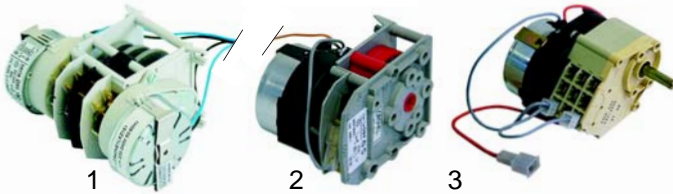

Item	Order	Description	Model	OEM
1	360298	180°, 360°, 540°, 4 cams	S950 (from No. 81060)	238030
2	360005	20°, regeneration	S623, S626, S633, S636, S653, 11_, 21_, 25_, 30_, 31_, 35_, 350_, 40_, 400_, 45_, 450_, 500_, 50_ (to No. 169214), E35, E40, E41, E42, E45	238011, 238052, 238006
3	360001	180°, 3 cams	R495, R497, R499, R501, R503, R507, R509, R511, R704, R706, R708, S641, S643, S870 (to No. 64902)	238001, 238025, 238024, 238005



Item	Order	Description	Model	OEM
1	360025	360°, timer, manual select	22_, 40f (DVGW),	238049, 238050AG
2	110085	timer knob	Clean 100, 10, 12,	226051
3	110087	circlip	66	499066
4	110086	rotary knob		447089

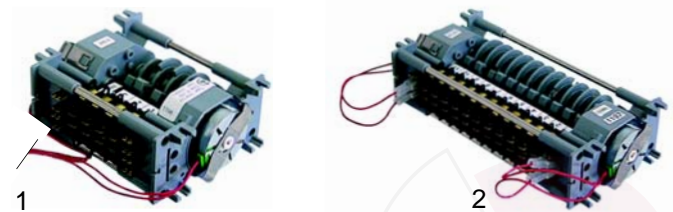

Item	Order	Description	Model	OEM
1	360134	60°/ 180°, 4 cams	500_	238061
2	360124	60°/ 120°/ 20°, 11 cams	Clean 3	238067



Item	Order	Description	Model	OEM
1	360126	6 cams	440f, E60, 14, E65 (from No. 910784), E100, E110, E120, E140 (from No. 910520)	926042
2	360133	60°/ 60°/ 20°, 4 cams	460f, 510_, E46, E50, E51, E52	238066
3	360132	20°	50_ (from No. 169214), f500_, 510_	238060



Item	Order	Description	Model	OEM
1	360299	120°/ 240°/ 360°, 5 cams	U61, U61H, U70, U132	929158
2	360135	60°/ 120°/ 180°, 6 cam		929098

## Pressure switches



Item	Order	Description	Model	OEM
1	541003	55/ 35 mm	S621, S623, S624, S626, S631, S633, S634, S636, S651, S651/ P, S653, S654, S655, S830, S835, S810, S815, S870, 21_, 25_, 30_, 31_, 22_, 40f (DVGW), Clean 3, 45_, 450_, 46_, 460_, 050F, 050FP, F85, F85P, E45, E46, E50, E51, E52	224003
2	541002	110/ 60	S641, S643, S850, S950, R495, R499, R501, R503, R505, R507, R509, R511, R704, R706, R708	224002
3	541001	35/ 17	11_, 11f (DVGW), 35_, 350_, 40_, 400_, E35, E85H, E40, E40H, E41, E42	224004



Item	Order	Description	Model	OEM
1	541106	90/ 56 (drain pump)	22_, 40f, 500_, 510_, 45_, 450_, 460_, 050FP, F85P, E46, E50, E51, E52	224005
2	541102	115/ 15/ (tank)	Clean 3	224006
3	541103	170/ 140 (safety)	Clean 3	224007



Item	Order	Description	Model	OEM
1	541013	55/ 20	E60, E65, Clean 100, 10, E100, E110	929039
2	541105	180/ 70	12, 14, E120, E140, U61, U61H, U70, U132	926049



Item	Order	Description	Model	OEM
1	541109	Y-piece	universal	035031
2	530560	hose 5 x 9, *PU = 5 m		143031, 143013, 143131

\* PU = packaging unit

### Thermostats



Item	Order	Description	Model	OEM
1	390004	30 - 90 °C	S621, S623, S624, S626, S631, S633, S634, S636, S651, S651/P, S654, S655, S810, S815, S830, S835, S850, S870, (from No. 64903), S950, 11_ (to No. 141000), 350_ (from No. 173349), 400_ (from No. 173349)	236004
2	390306	85 °C	11_ (from No. 141001), 21_, 25_, 30_, 31_, 350_, 400_, 500_, 10, 12, 14, 66	236022, 236027



Item	Order	Description	Model	OEM
1	390001	53 °C	11- (from No. 141001), 40f (DVGW), 21_, 25_, 30_, 31_, Clean 100, 10, 12, 14	236023
2	390316	55 °C	350_ (from No. 21828), 400_ (from No. 21828), 66	236024

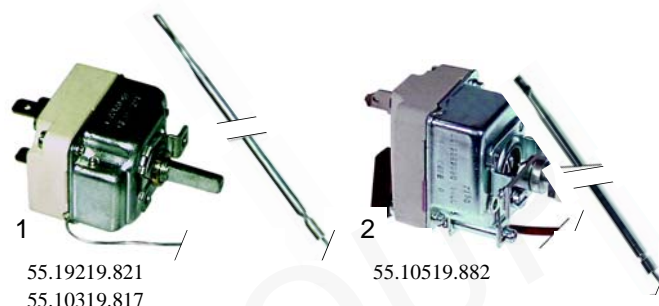

Item	Order	Description	Model	OEM
1	390307	30 - 90 °C	11f (DVGW), 40f (DVGW), 21_, 25_, 30_, 31_,	236025, 236030, 236037
2	390309	safety thermostat, 115 °C	11f (DVGW), 40f (DVGW), 21_, 25_, 30_, 31_	236031, 236026

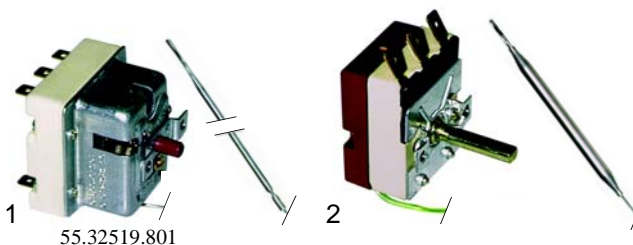

Item	Order	Description	Model	OEM
1	375139	safety thermostat, 108 °C	40F (DVGW)	236032
2	375006	30 - 85 °C	Clean 3	236046, 236041



Item	Order	Description	Model	OEM
1	390310	55 °C	500_, E45, E46, E50, E51, E52	236042, 236028



## Thermostats



Item	Order	Description	Model	OEM
1	390301	60 °C ± 3 °C	Clean 3, 350_, 400_, E35, E40, E41, E42	236035
2	390319	80 °C ± 3 °C	E35, E40	236048
3	550388	clamp ring		431006

## Safety thermostats



Item	Order	Description	Model	OEM
1	390318	95 °C ± 3 °C	E35, E35H, E40, E40H, E41, E42	236047
2	390233	110 °C ± 3 °C	Clean 3, 11_, 22_, 44_, 440_, 45_, 450_, 46_, 460_, 050F, 050FP, F85, F85P, E35, E35H, E40, E40H, E41, E42, E45, E46, E50, E52, E60, E65, E100, 10, 12, 14, E100, E110, E120, E140, U61, U61H, U70, U132	236039, 926189

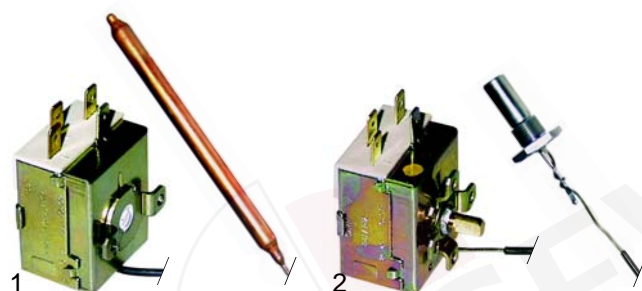

Item	Order	Description	Model	OEM
1	390421	85 °C	500_, 510_, E41, E42, E45, E46, E50, E51, E52, E60, E65, Clean 100, E100, E110, E120, E140, U61, U61H, U70, U132	236043, 929107
2	390005	0 - 85 °C	S621, S623, S624, S626, S631, S633, S634, S636, E60, E65, E100, E110, E120, E140, U61, U61H, U70, U132	236003, 236014, 926196

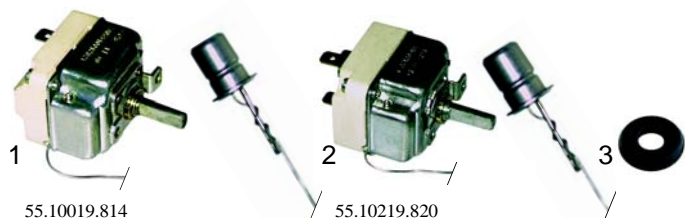

Item	Order	Description	Model	OEM
1	390002	30 - 90 °C	S870 (to No. 64902), R501, R503, R505, R507, R509, R511, R704, R706, R708	236008, 236002
2	390003	30 - 90 °C	R495, R497, R499, R708	236007
3	510165	gasket		

## Micro switches



Item	Order	Description	Model	OEM
1	345257	1-pole-changeover	S621, S623, S624, S626, S631, S633, S634, S636, S651, S651/ P, S654, S655, S810, S815, S830, S835, R501, R503, R505, R507, R509, R511, R704, R706, R708, 44f, 440f	218002
2	345585	1-pole	S870	218003
3	345586	2 NO + 2 NC	S850, S950	999022, 218007



Item	Order	Description	Model	OEM
1	345580	2-pole	11_ (to No. 141000)	218010
2	345032	1-pole	66	218011

## Magnetic switches



Item	Order	Description	Model	OEM
1	345146	6 x 30 mm	11_ (from No. 141001), 22_, 40f (DVGW), Clean 100, 10, 12, 14	211001
2	345118	13 x 32 mm	21_, 25_, 30_, 31_, 35_, 350_, 40_, 400_, Clean 3, 44f, 440f, 45_, 450_, 46_, 460_, 050F, 050FP, F85, F85P, 50_, 500_, 510_, E35, E35H, E40, E40H, E41, E42, E45, E46, E50, E51, E52	211002

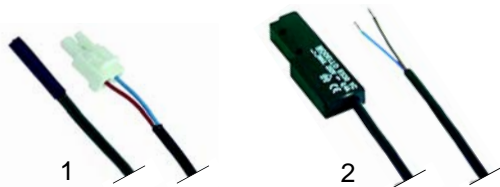

Item	Order	Description	Model	OEM
1	345630	6 x 30 mm	E60, E65, E100, E110, E120, E140	926195
2	345116		U61, U61H, U70, U132	927017

## Solenoid valves



Item	Order	Description	Model	OEM
1	370017	single, 230 V	universal	240005, 240011
2	370021	double, 230 V	universal	240003
3	370247	triple, 230 V	universal	240002



Item	Order	Description	Model	OEM
1	370015	single, 230 V	R495	240006
1	370243	single, 230 V (with reducer)	Clean3	240012
2	370246	double, 230 V (with reducer)	universal	240010, 240999
3	370315	double, 230 V (with reducer)	U61, U61H, U70, U132	929172

## Relays



Item	Order	Description	Model	OEM
1	380130	3 NO	S651, S651/ P, S653, S654, S655, S810, S815, S830, S835, S850, S870, S950, 11_	229006, 229008
2	380131	3 changeover		229007, 229009



Item	Order	Description	Model	OEM
1	380311	1 NO + 1 NC, 20 A	21_, 25_, 30_, 31_, 350_, 400_, Clean 3, 44f, 440f, 450_, 460_, 500_, 510_, E45, E46, E50, E51, E52	229030
2	380185	1 NO, 30 A	22_, 40f (DVGW), Clean 3, 44f, 440f, 050F, 050FP, F85, F85P, 50_, 500_, E60, Clean 100, 10, E100	229025, 229029
3	380312	3 changeover, 10 A	22_, 40f (DVGW), Clean 3, 460_, 500_, 510_, E35, E40, E50, E51, E52, Clean 100, 10, 12, 14, 66, U61, U61H, U70, U132	229023, 229024



Item	Order	Description	Model	OEM
1	380403	3 changeover, 16 A	050F, 050FP, F85, F85P, E60, E65, E100, E110, E120, E140, U61, U61H, U70, U132	229036, 929115
2	380139	2 changeover, 16 A	Clean 100, 10	926021

## Contactors



Item	Order	Description	Model	OEM
1	380245	3 NO + 1 NC	44f, 440F, 050F, 050FP, F85, F85P, 500_, 12, 66	229010, 229011, 229019, 229032
2	380231		E110, E120, E140	926147
3	380239	3 NO + 1 NC	12, 14	926040
3	380238	3 NO + 1 NO	E110, E120, E140	929122

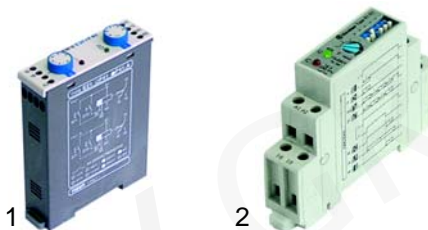

Item	Order	Description	Model	OEM
1	380164	time relay/ drain pump	45_, 450_, 46_, 460_, E45, E46, E50, E51, E52	238064
2	380611	time relay/ drain pump	E60, E65, E100, E110, E120, E140	929113

## Connector blocks



Item	Order	Description	Model	OEM
1	550349	3-pole	universal	220010
2	550411	6-pole		220011

## Interference suppression filters



Item	Order	Description	Model	OEM
1	365047		universal	926144
2	365048			212001

## Dosing pumps

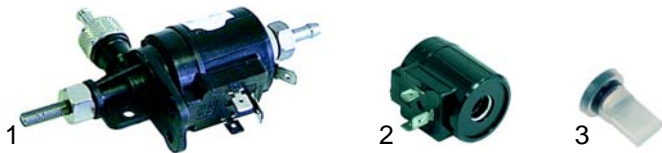

Item	Order	Description	Model	OEM
1	361004	DB2, 230V (rinse aid)	universal	987001, 987020
2	361113	solenoid coil		201002
3	510298	non-return valve		144012

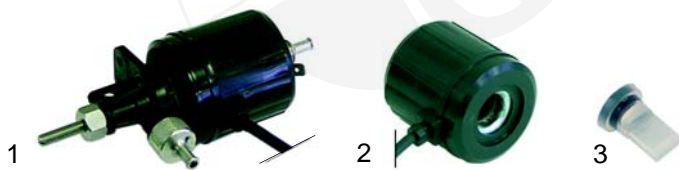

Item	Order	Description	Model	OEM
1	361005	DS5, 230V (detergent)	universal	987012, 987021
2	361114	solenoid coil		201018
3	510298	non-return valve		144012



Item	Order	Description	Model	OEM
1	361026	EV1, 230V	Clean 3, 44f, 440f, 46_,	987017
2	361365	solenoid coil	460_, 66,	201020
3	361366	p.c.b.	Clean 100, 10, 12, 14	215001



Item	Order	Description	Model	OEM
1	361027	0,75 l/h (detergent)		209009
2	361130	tube, compl.	45_, 450_, 46_, 460;	143181
3	361128	tube		



Item	Order	Description	Model	OEM
1	361025	2,2 l/h (detergent)		209012
2	361130	tube, compl.	E35, E40, E41, E42, E45, E46, E50, E51	143181
3	361128	tube		

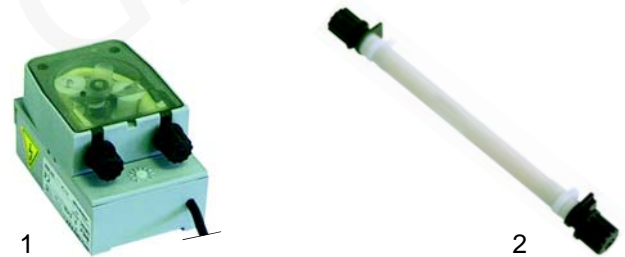

Item	Order	Description	Model	OEM
1	361215	3 l/h (detergent)	E35, E35H, E40, E40H,	209016
2	361134	tube, compl.	E52, E60, E65, E100, E110, E120, E140, U61, U61H, U70, U132	



Item	Order	Description	Model	OEM
1	361362	diaphragm (rinse aid)		987023
2	361363	membrane	050F, 050FP, F85, F85P	199012
3	510298	non-return valve		144012



Item	Order	Description	Model	OEM
1	361039	diaphragm pump	U61, U61H,	929198
2	361307	membrane	U70, U132	



Item	Order	Description	Model	OEM
1	513043	container filter	Uni	121017
2	361270	chemical feed elbow		468151, 999104

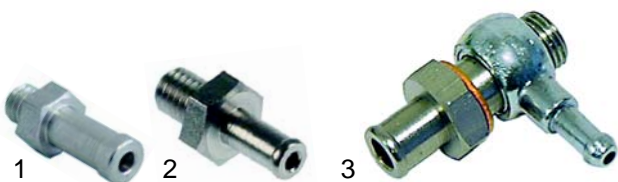

Item	Order	Description	Model	OEM
1	518370	boiler connection	universal	468114
2	518348	boiler connection		468117
3	510107	boiler connection	S_, R_	991001



Item	Order	Description	Model	OEM
1	518544	suction tube, compl.	Clean 3	986006
2	518569	suction tube, compl.		986007

## Heating elements

Tanks and heating elements



Item	Order	Description	Model	OEM
1	415010	2000W, 230V	S621, S623, S624, S626, S631, S633, S634, S636, 11_, 21_, 25_, 30_, 31_	230017, 230009, 230044
2	415664	2250W, 230V	11_, 50_, 500_, E41, E42, E45	230085, 230006
3	415665	3000W, 230V	22_, 40f (DVGW), 50_, 500_, E46, E50, E51, E52, E60, E65, Clean 100, 10, 12, 14	230060, 230061, 230086



Item	Order	Description	Model	OEM
1	415666	1100W, 230V	35_, 350_, 40_, 400_	230077
2	416234	600W, 230V	E35, E35H, E40, E40H	230098
3	415008	2000W, 230V	R495	230016

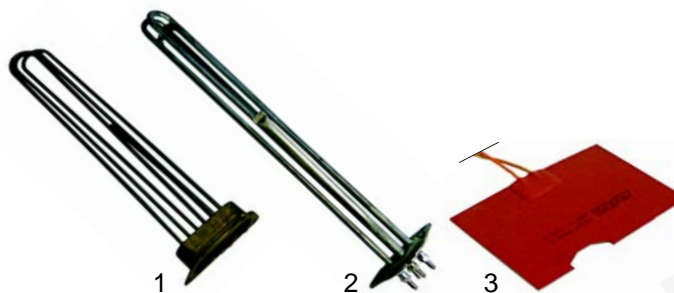

Item	Order	Description	Model	OEM
1	415007	4500W, 3 phases 230V	S651, S651/ P, S653, S654, S655, S810, S815, S830, S835, S850, 66	230018, 230035, 230082
2	415001	4500W, 3 phases 230V	S870	230013, 230014, 230034, 230081
3	416236	1250W/230V	Clean3	230080.AG



Item	Order	Description	Model	OEM
1	510416	gasket, 10Ø		437022
2	520231	nut, M10 x 1		
3	510417	gasket, 14Ø		437024
4	520230	nut, M14 x 1,5		
5	510387	gasket		437086
6	510388	clamp		



Item	Order	Description	Model	OEM
1	510410	gasket		456008
2	510408	O-ring		456002

### Boiler heating elements



Item	Order	Description	Model	OEM
1	415005	2000W, 230V, 1 1/4"	R497, R499, R501, R503, R505, R507, S641, S643	230003, 230002
2	415011	3000W, 230V, 1 1/4"	R509, R511, R704	230007, 230021
2	n.l.a.	3000W, 230V, 1 1/4"	R706	230024
3	415004	3000W, 230V, 1 1/2"	R708, S870 (to No. 64902)	230008, 230026
4	510405	gasket., 1 1/4"		437028
4	510406	gasket., 1 1/2"		437029

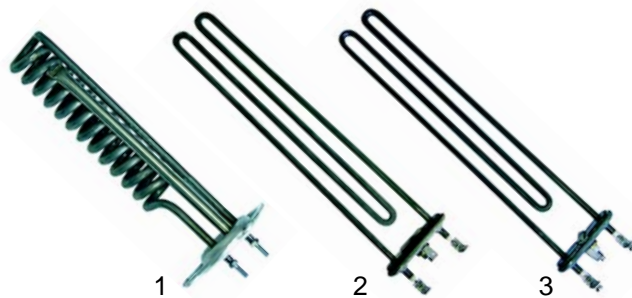

Item	Order	Description	Model	OEM
1	415668	2625W, 230V	S621, S623, S624, S626, S631, S633, S634, S636, 21_, 25_, 30_, 31_	230012, 230090, 230023
2	415009	2600W, 230V	11_, 35_, 350_, 40_, 400_, E35, E35H, E40, E40H, E41, E42, E45, 45_, 450_	230057, 230058, 230087
3	415000	3000W, 230V	E46, 46_, 460_, 050F, 050FP, 50_, 500_, 510_, E50, E51	230088, 230075, 230076



Item	Order	Description	Model	OEM
1	416280	2700W, 230V	Clean 3	230091
2	415001	4500W, 3 phases 230V	Clean 3, E52, 10, 12, 14, Clean 100, 66, E100, E140, S950	230013, 230014, 230034, 230081



Item	Order	Description	Model	OEM
1	416240	6000W, 3 phases 230V	F85, F85P, E60, U61, U61H	230083
2	416241	8000W, 3 phases 230V	E65, E110, E120, U70, U132	230095, 230020
3	510408	gasket		456002
4	510093	protecting cover		467002

### Boilers

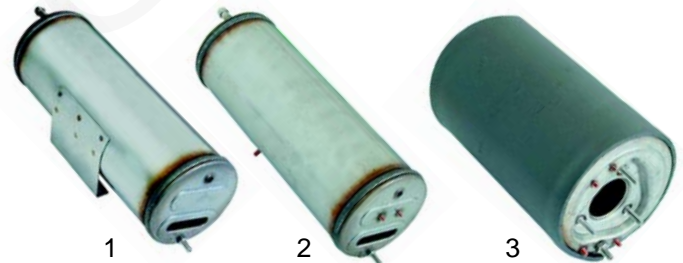

Item	Order	Description	Model	OEM
1	510029	boiler	11_	104019, 104023
2	518373	boiler (DVGW)	11_, 35_, 350_, 40_, 450_, E41, E42, E45	104027, 104025
3	518571	boiler (DVGW)	21_, 25_, 30_, 31_	982012

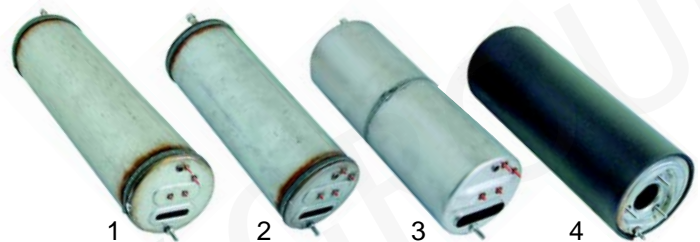

Item	Order	Description	Model	OEM
1	518377	boiler (DVGW)	46_, 460_, 50_, 500_, E46, E50, 050F, 050FP	104026
2	518572	boiler (DVGW)	E35, E40	104039
3	518573	boiler (DVGW)	E35H, E40H	104044SO
4	518577	boiler (DVGW)	66	982011

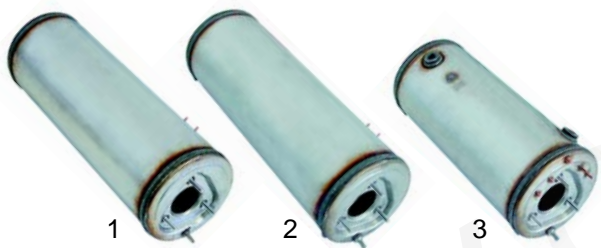

Item	Order	Description	Model	OEM
1	518574	boiler (DVGW)	22_	104020
2	518378	boiler (DVGW)	510, E51, E52	104030
3	518575	boiler (DVGW)	Clean 3	104028

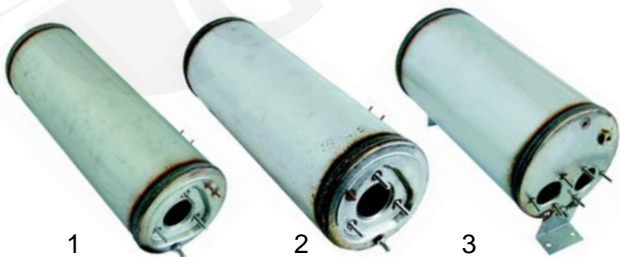

Item	Order	Description	Model	OEM
1	518576	boiler (DVGW)	F85, F85P	104050
2	513241	boiler (DVGW)	E60, E100, E110, 10, Clean 100	926026
3	513242	boiler (DVGW)	E65, E120, E140, 12, 14	926055

## Pumps

### Drain pumps

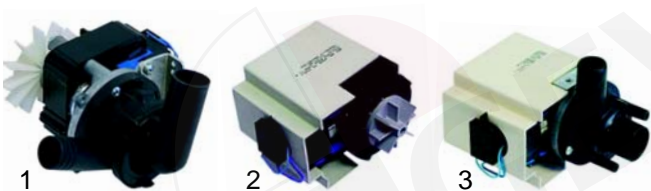

Item	Order	Description	Model	OEM
1	500057	100W, 230V	S_, R_	130021, 130022
2	500212	100W, 230V	Clean 3	130112
3	500546	100W, 230V	44f, 44of	130094

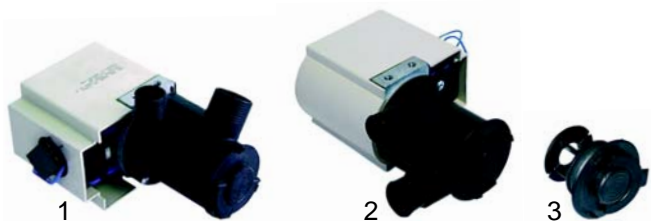

Item	Order	Description	Model	OEM
1	500213	100W, 230V	22_	130071, 130084
2	500087	100W, 230V	21_, 25_, 30_, 31_	130070, 130083
3	500307	filter		121053



Item	Order	Description	Model	OEM
1	500350	100W, 230V	E60, E65, E120, E140	929114
2	500247	100W, 230V	E100, E110	926103



Item	Order	Description	Model	OEM
1	500210	34 W, 230V	45_, 450_, E35H, E40H, E41, E42, E45	130123
2	500214	34 W, 230V	46_, 460_, E46, E50, E51, 050F, 050FP, F85, F85P	130105
3	500215	34 W, 230V	E35, E40	130138

### Booster pumps



Item	Order	Description	Model	OEM
1	500060	0,45 HP, 230V	universal	130013, 130052
2	500037	0,10 HP, 230V	U61, U61H	929167
3	500358	0,6 HP, 230V	Clean 3, E45, E46, 45_, 450_, 46_, 460_, 50_, 500_, E50, E51, E60, E65, U70, U132	130120, 130102

### Wash pumps



Item	Order	Description	Model	OEM
1	500005	0,25 HP, 230V	11_, E41, E42	130050, 130086, 130085
2	500003	0,40 HP, 230V	S621, S623, S624, S626, S631, S633, S634, S636, 21_, 25_, 30_, 31_	130008, 130007, 130065, 130026, 130001, 130089, 130090
3	500094	0,15 HP, 230V	35_, 350_	130099, 130107



1

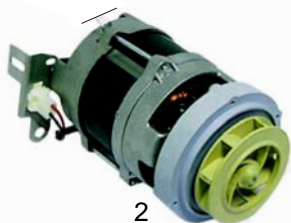

2

Item	Order	Description	Model	OEM
1	500542	0,20 HP, 230V	40_, 450_	130097, 130108
2	500154	0,15 HP, 230V	E35, E35H	130135, 999134
2	500150	0,28 HP, 230V	E40, E40H	130136, 999135



1



2

Item	Order	Description	Model	OEM
1	500148	1,5 HP, 230V	S651, S654, S810, S815, S830, S835	130042, 130045, 130059
2	500361	1 HP, 230V	Clean 100, 10	926078



1



2

Item	Order	Description	Model	OEM
1	500152	0,48 HP, 230V	E45, 45_, 450_	130122
2	500156	0,80 HP, 230V	E46, 46_, 460, E46, 050F, 050FP, F85, F85P, 50_, 500_, E50	130098, 130109



1



2

Item	Order	Description	Model	OEM
1	500023	1,5 HP, 400V, (3 ph)	66, S850, S870	130025
2	500155	1,5 HP, 230V	66, S850, S870	130039



1



2

Item	Order	Description	Model	OEM
1	500543	1 HP, 230V	510_, E51	130126
2	500002	1,2 HP, 230V	E52, to No. 80211: S651, S651/P, S653, S654, S655, S830, S835	130018, 130017, 130068, 130069, 130079, 130080



1



2

Item	Order	Description	Model	OEM
1	500362	1,5 HP, 400V, (3 ph)	E110	926146
2	500545	1,5 HP, 400V, (3 ph)	12, 14, E120	926148, 926079



1



2

Item	Order	Description	Model	OEM
1	500544	1 HP, 230V	E60, Clean 100; E100	926151
2	500117	2 HP, 230V	E65, E140	92920, 926150



Item	Order	Description	Model	OEM
1	500111	1,5 HP, 400V, (3 ph)	S870	130002
2	500119	1,5 HP, 230V	S870	130038



1



2

Item	Order	Description	Model	OEM
1	500001	1,5 HP, 400V (3 ph)		130020
2	500091	1,5 HP, 400V (3 ph)	S651, S654, S810, S815, S830, S835	130058, 130043



Pumps OEM		1 Impellor		2 Mechanical seal		3 Housing gasket		4 Pump cover		5 Capacitor	
Order	OEM	Order	OEM	Order	OEM	Order	OEM	Order	OEM	Order	OEM
500001	130020	509020	124031	510703	14107	510554	456024	521547	116013	365019	206005
500002	130068	509020	124031	510703	141007	510554	456024	521547	116013	365019	206005
500003	130065	510615		510693	141002	510554	456024	510512		365013	206001
500005	130086	509001	124028	510693	141002	509002	456038	509003	315013	365017	206008
500023	130025	510602	124002	510693	141002	510551	456023	521513	116002	-	-
500037	929167	521205	929173	510695	927190	509002	456038	510384	929182	365017	206008
500091	130043	521252	124012	510703	141003	510554	456034	521547	116013	-	-
500094	130107	521200	-	510695	-	509002	-	510384	-	365012	206009
500111	130002	510357	-	510693	-	510551	-	510531	-	-	-
500117	926150	521214	926149	510693	141002	510551	456023	510502	116002	-	-
500119	130038	510612		510693	141002	510551	456023	510531	-	365016	206006
500148	130042	521252	124012	510703	141003	510554	456034	521547	116013		
500150	999135	509004	124049	510703	141007	521703	406038	518177	111023	365012	206009
500152	130122	509007	124043	510693	141002	521722	456038	521550	116024	365013	206001
500154	999134	521221	124048	510703	141007	521703	456038	518177	111023	365017	206010
500155	130039	510602	124002	510693	141002	510551	456023	510502	116002	365016	206006
500156	130109	509020	124031	510703	141007	510554	456024	521548	116019	365021	206004
500361	926078	509020	124031	510703	141007	510554	456024	521547	116013	365019	206005
500362	926146	521240	-	510694	-	521712	-	521536	-	-	-
500542	130108	521228	124032	510703	141007	521704	456038	521523	116018	365012	206009
500543	130126	509020	124031	510703	141007	510554	456031	521548	116019	365021	206004
500544	926151	518067	926152	510692	141002	510552	437049	521512	116015	365021	206004
500545	926148, 926079	521214	926149	510693	141002	510551	456023	510502	116002	-	-

