



## Making Cabin

It is possible to make special cabins which are appropriate to all kind of outer side of machines together with different colors of plexiglasses with the help of those equipments. You can see various kinds of covers at the cabin components division.

Cabins



Cabins



Compartment Cabinet



Filling Machine Cabinet



Hangern Robot Cabinet



Hinge Cabinet



Hydraulic Press Off



Label Machine Cabinet



Laser Cutting Machine Cabinet





Machine Cabinet



Motor Unit Off



Packing Machine Cabinet

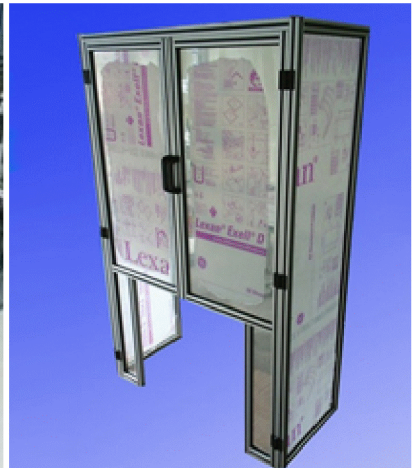
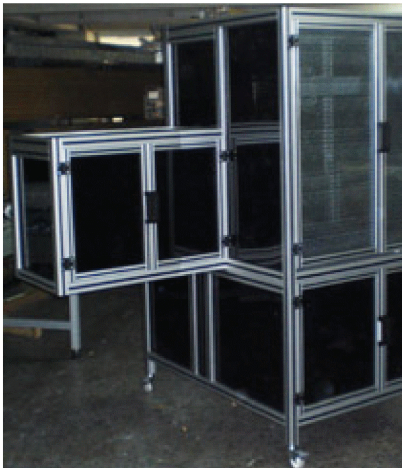

Yarn Machine Cabinet





## Automation Applications

The aspects of the point that our age has reached which requires quality in production and serial production make automation very important. Aluminium profiles are ideal infrastructure materials in automation formations.

Board Transfer Units 1



Board Transfer Units 2



Board Transfer Units 3

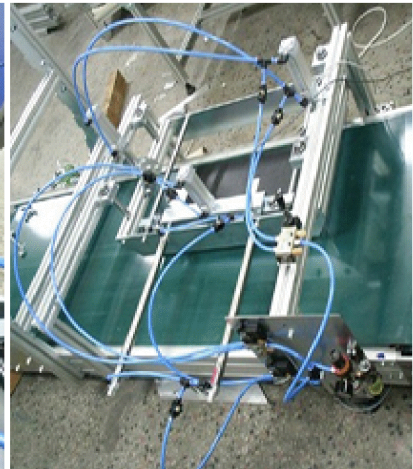

Elevator Group



Pallet Loading Automation



Product Packaging Automation

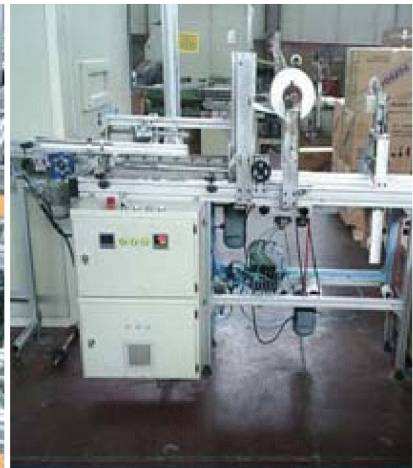

Pet Cup Machine Views 1



Pet Cup Machine Views 2

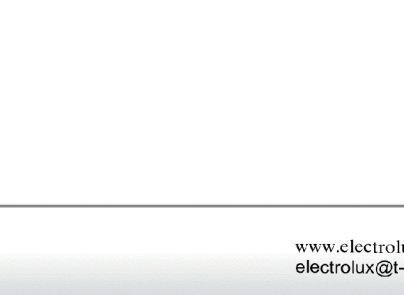

Pet Cup Machine Views 3



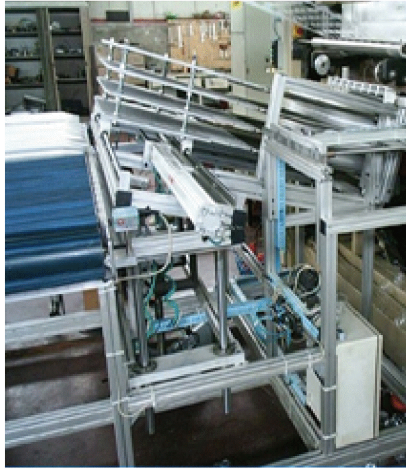

Socks Strecting Machines 1



Socks Strecting Machines 2



Socks Strecting Machines 3



Source Point

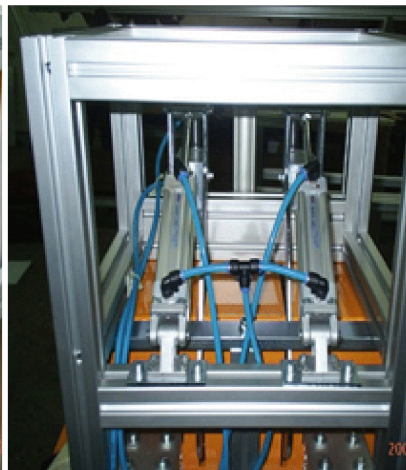

Styrofoam Line





## Mechanical Applications

In machine production very important practicability can be achieved by aluminium profiles.  
 With combination of connection options required resistant is established  
 It is practical so cost and time advantages are preference reason

1200x1400 CNC Milling



CNC Chassis



Control Unit Housing



Elevator



Leather Cutting Machine



Mechanical Chassis

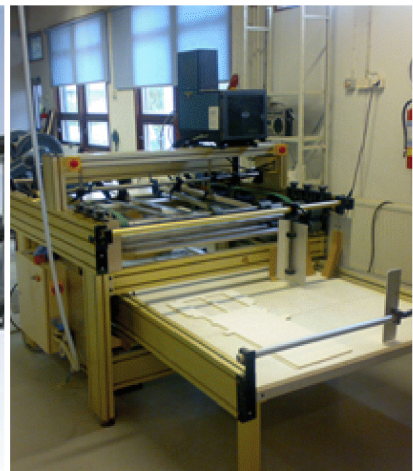

Mechanical Chassis

Packing Machine

Packing Machine Body



Pallet Supply

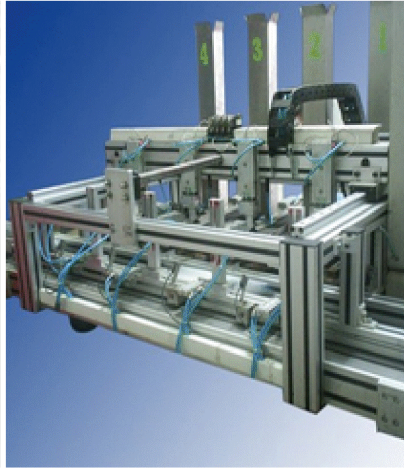

Printing Machine



Roter Table Type CNC

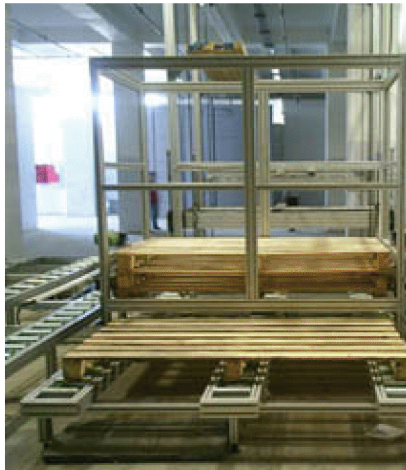

Screw Shaft and Applications Studs



Split Roller Bearing Application

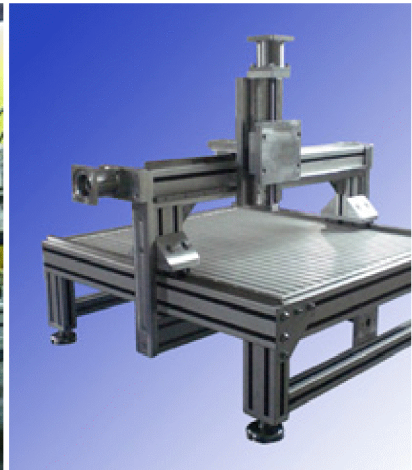

Trigrel and Liner Connection Details

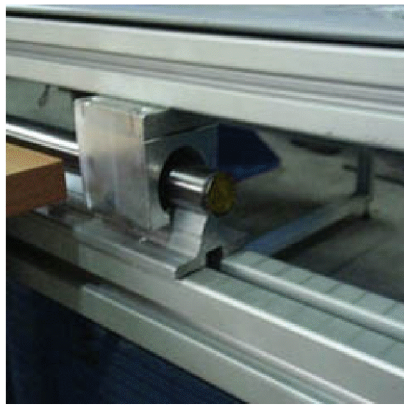
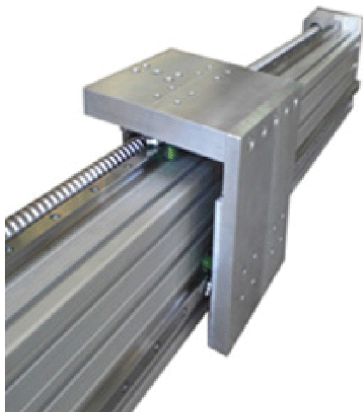



## Conveyors

By the means of profiles designed specially for outer sides of all kind of machines, it is possible to produce fast. Requested sizes of conveyor can be produced.

Two Storeys Conveyor



Avare Roller Conveyor



Barrier Bar Conveyor



Chain Belt Conveyor



Conveyor



Custom Conveyor





Grade Metal Pedestal Conveyor L-type Elevator

Miniature Conveyor



Narrow Band Press Conveyor

Narrow Conveyor

Oring Conveyor Belt

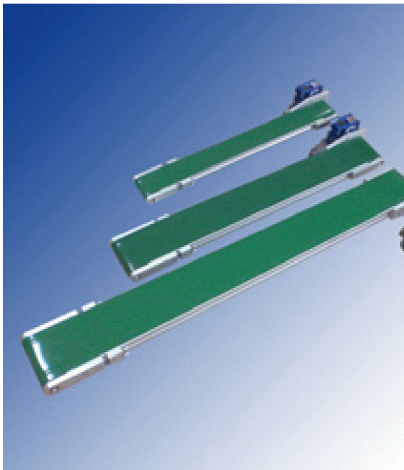



PVC Belt Conveyor



PVC Conveyor - Metal Pedestal



Rated Conveyor



Rated Conveyor Applications



Roller Conveyor Line



Z Type Elevator





## Profile Applications Chassis

Combination of standard connection elements and specific sigma profile section, required momentum can be achieved at body of machines and chasis

Bench Table

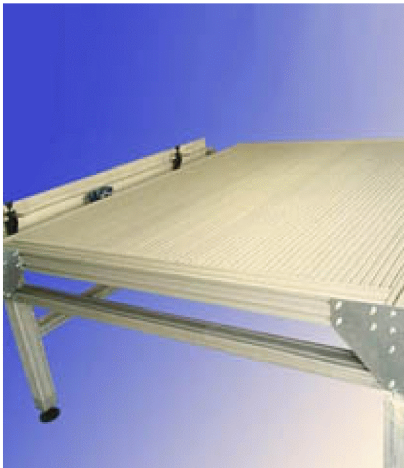

Machine Cabinet

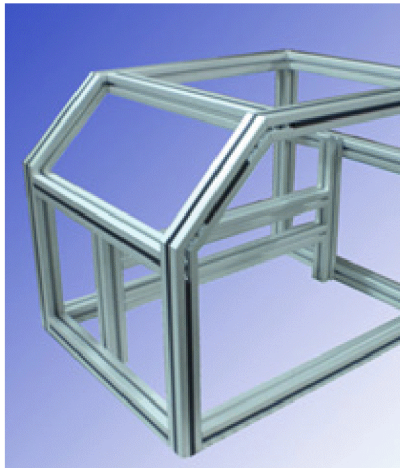

CNC Router Front Side

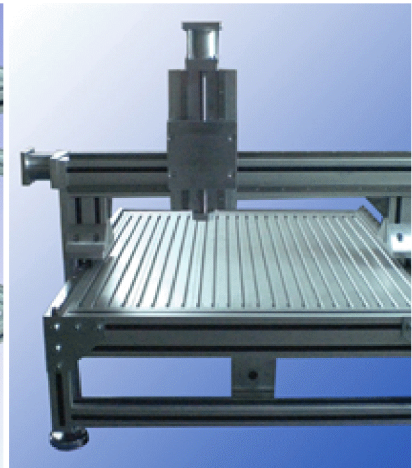

Drawer



Education Board



Education Board (no foot)





Elevator Chassis



Fair Stand

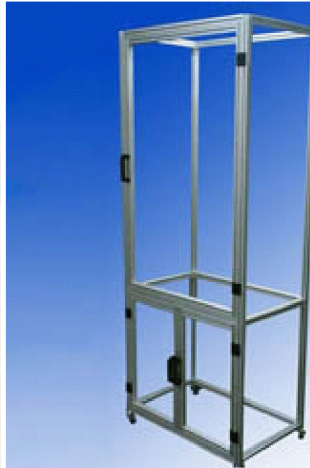

Laser\_Table



Machine Chassis

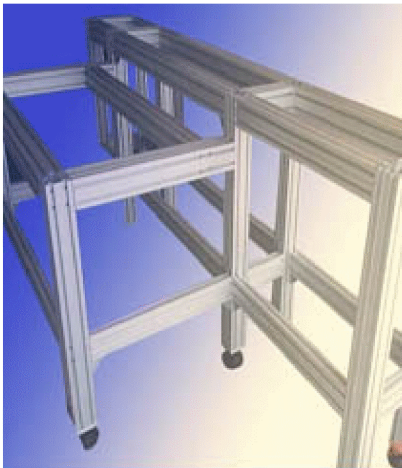

Motor Connection Chassis

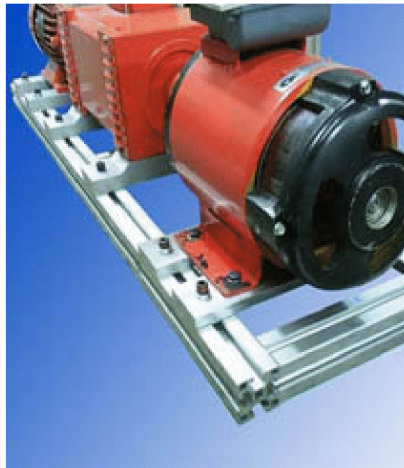

Rated Chassis

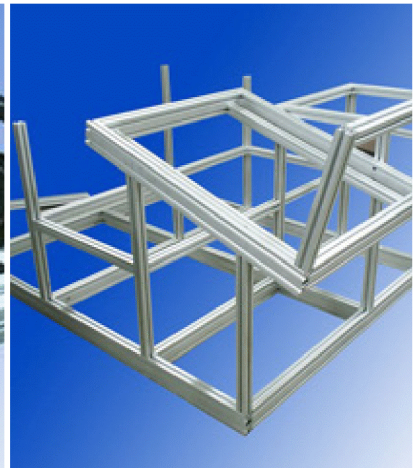

RobotSavingCabined



Serigraphy Posing Machine

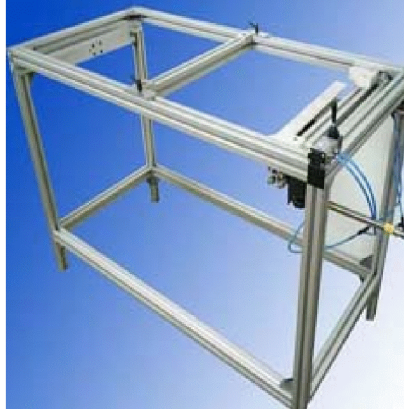

Single Bridged Guiding

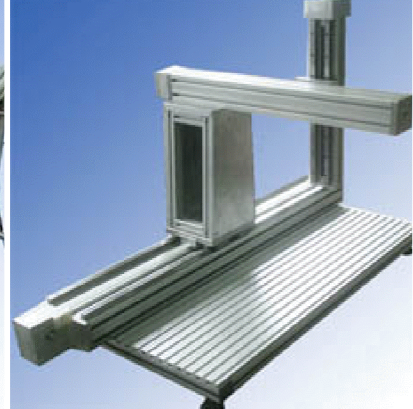



Stair Platform



Table



Wheeled Service Car

