















КЕТЕРИНГ ОПРЕМА









	Материјал	Температура	Изглед	Забелешка
 COLD	 polyethylene terephthalate	-40°C / +70°C	Кристално, црно	Замрзнувачки ❄️❄️❄️
	 Polystyrene	-5°C / +80°C	Обоено, транспарентно	
 WARM	 Polypropylene	-20°C / +130°C	Прозирен	Запечатено  Микробраново  Замрзнувачки ❄️❄️❄️



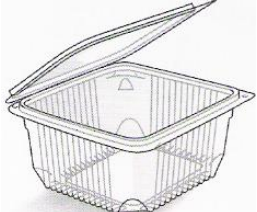

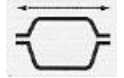
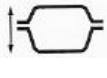

Легенда	
	Надворешни димензии
	Внатрешни димензии
	Висина
	Содржина (ml)
	Готовина и кеса за носење
	Палета
	Време потребно да се испорачаат
	На залиха



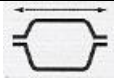

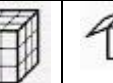

САДОВИ И ПОСЛУЖАВНИЦИ ЗА ЛАДНА УПОТРЕБА

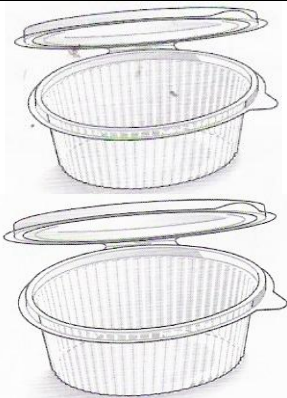

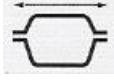
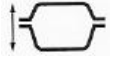

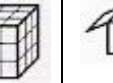

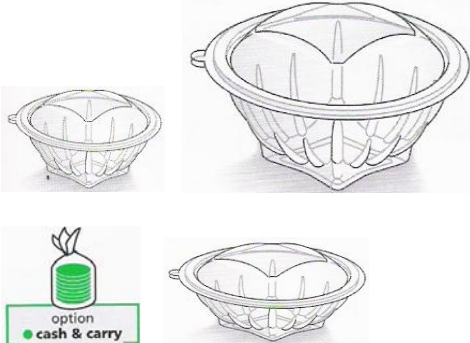
MULTIPACK		Салати и различни мешавини Salad and various mixtures						
		Шифра Reference						
 		M125	103x87	34	125		4x4	800
		M250	126x106	41	250	100	3x9	360
		M370	139x116	46	370	50	2x7	420
		M500	151x125	51	500	50	2x6	420
		M750	174x146	59	750	50	4x3+2	300
		M750H30	174x146	41	450		4x3+2	300
		M1000	196x158	62	1000	40	3x3	240
		M1500	219x179	68	1500		3x4	150
		M2000C	240x195	72	2000	50	3x4	200
		M2C750	174x146	59	X2		4x3+2	270
		M3C550	196x159	39	X3		3x3	240
		M3C900	219x179	48	X3		3x4	150
		M3C2000	240x195	54	X3		3x4	200

ОПТИРАСК	Сад со рамен капак Container with flat lid						
 	Шифра Reference						
	X250D	125x113	42	250	50	2x8	600
	X370D	125x113	57	370	50	2x8	600
	X500D	125x113	73	500		2x8	600
	X250G	140x125	37	250		2x7	660
	X370G	140x125	47	370		2x7	660
	X500G	140x125	57	500	50	2x7	600
	X750G	140x125	89	750	45	2x5	540
	X250J	163x130	27	250		2x6	660
	X450J	163x130	42	450		2x6	660
	X600L	187x138	45	600		2x7	400
	X750L	187x138	53	750	50	2x7	400
	X1000L	187x138	67	1000	50	2x7	400
	X1500S	188x188	68	1500	60	3x5	240
	X2000S	188x188	87	2000	60	3x5	240
	X490V	232x180	22	490		3x4	300
	X900V	232x180	35	900		3x4	300
	X1150V	232x180	45	1150		3x4	300
	X1350V	232x180	54	1350		3x4	300
	X1900V	232x180	72	1900		3x4	260
	X500T	232x147	27	500		3x5	320
	X1000T	232x147	52	1000		3x4	320
	X750LSP	187x138	53	750	fork	2x7	400

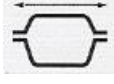
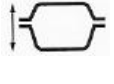
ELIPACK	Овален сад со рамен капак Oval container with flat lid						
	Шифра Reference						
	EL150	150x110	30	150	100	2x5	800
	EL250	150x110	45	250	100	2x5	800
	EL390	165x132	45	300	100	2x6	600
	EL500	165x132	57	500	100	2x6	600
	EL760	202x165	52	760	100	3x3	300
	EL1000	202x165	72	1000	100	3x3	300
	EL1500	249x202	70	1500	100	3x4	200
	EL2000	249x202	89	2000	100	3x4	200

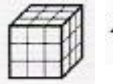
SEKIPACK	Сад со капак што се трга Container with tear off lid						
	Шифра Reference						
 	SLR150	120	55	150		3x7	420
	SLR250	120	68	250	60	3x7	360
	SLR370	136	77	370	50	4x4	300
	SLR500	156	84	500	50	3x4	300
	SLR600	172	84	600		4x5	230
	SLR750	172	94	750	50	4x5	200
	SLR501	187	70	500		3x5	300
	SLR1000	186	102	1000	50	3x5	240

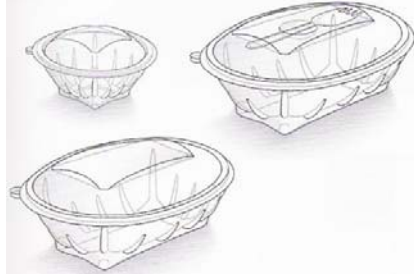
	Сад со лажичка или вилушка Container with spork or spoon						
	Шифра Reference						
	SLR150SP	120	55	150	spoon	3x7	420
	SLR250SP	120	68	250	spoon	3x7	360
	SLV370SP	190X140	64	370	Spork	2x7	400
	SLV500SP	190X140	76	500	Spork	2x7	400
	SLV370	190X140	64	370		2x7	400
	SLV500	190X140	76	500		2x7	400









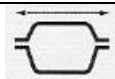
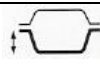

TULIPACK	Сад со капак што се трга Containers with tear off lid						
	Шифра Reference				кеса		
	TUL250	117x117	63	250	80	4x4	800
	TUL370	132x132	70	370	75	4x5	450
	TUL500	147x147	73	500	65	4x4	390
	TUL750	158x158	93	750	90	2x6	450
	TUL1000	172x172	98	1000	65	3x4	390



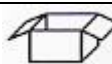

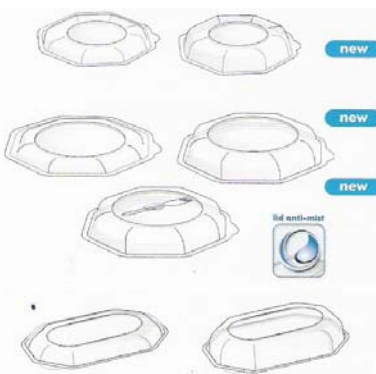
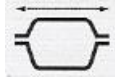
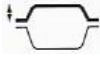
OLIPACK	Садови за маслинки и овошни салати Containers for olives and fruit salads						
	Шифра Reference						
	OLI251	120	47	250		2x8	480
	OLI401	120	67	400		2x8	480
	OLI501	120	80	500		2x8	480





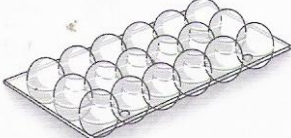
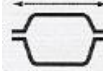







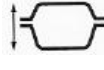

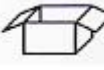
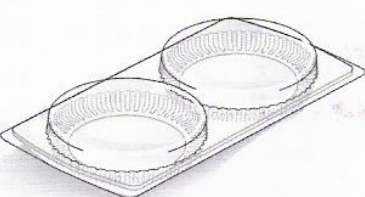
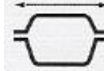

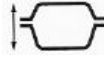

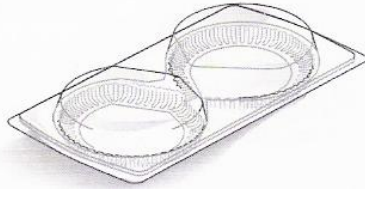
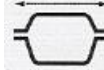
KITIPACK	Чинија за презентација Presentation platters						
	Шифра Reference						
	1311KF10	183x167	150x130	провидна		3x6	480
	2215KF10	280x210	245x160	провидна		4x4	240
	Капак за чинија Platters lid						
	Шифра Reference						
	1311KF02	160x140	150x130			5x6	480
	2215KF02	280x210	245x170			3x7	240

CRUDIPACK	Основи Bases						
	Шифра Reference						
	FCR140H25	160x160	25	370	Кристално		
	FCR140	160x160	35	500	Кристално		
	FCR170	190x190	35	750	Кристално		
	FCR170N	190x190	35	750	Црно		
	FCR170H45	190x190	45	1000	Кристално		
	Капаци Lids						
	Шифра Reference						
	CVCR140	160x160	20				
	CVCR170	190x190	20				
		Основа и капак Base and Lid					
	Шифра Reference						
	CR140H25C	160x160	48	370	кристално		
	CR140C	160x160	56	500	Кристално		
	CR170C	190x190	59	750	Кристално		
	CR170NC	190x190	59	750	Црно		
	CR170H45C	190x190	65	1100	кристално		

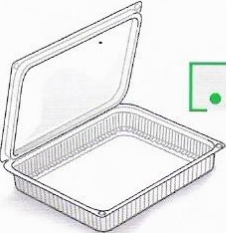
SNACKIPACK	Црни основи Black bases					
	Шифра Reference					
	19SKN	198x100	175x75	20	9x6	450
	23SKN	180x135	155x115	20	8x6	300
	33SKN	240x140	215x120	20	6x6	450
	45SKN	245x185	225x165	20	6x4	400
	79SKN	327x247	300x220	20	4x6	200
	Капаци Lids					
	Шифра Reference					
	19SK04	207x113	175x75	40	4x4	450
	19SK06	207x113	175x75	60	4x4	450
	23SK02	192x145	155x115	20	4x4	300
	33SK02	250x155	240x140	20	3x4	450
	45SK02	258x198	225x165	20	3x4	400
	45SK04	258x198	225x165	35	3x4	400
79SK04	340x255	300x220	35	3x4	200	



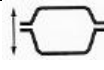

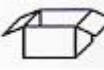

ОСТОРАСК	Индивидуални чаши (садови) за салата Individual salad bowls							
	Шифра Reference				Боја Color			
	SL110H15N	110	15		Црна	75	4x4	1500
	SL110H56C	110	56	250	Кристална	75	4x4	1500
	SL110H56N	110	56	250	Црна	75	4x4	1500
	SL130H39C	130	39	250	Кристална	75	3x7	750
	SL130H39N	130	39	250	Црна	75	3x7	750
	SL170H25C	170	25	250	Кристална	50	3x6	600
	SL170H25N	170	25	250	Црна	50	3x6	600
	SL170H42B	170	42	500	бела	50	3x6	600
	SL170H42C	170	42	500	Кристална	50	3x6	600
	SL170H42N	170	42	500	Црна	50	3x6	600
	SL170H62C	170	62	750	Кристална	50	3x6	600
	SL170H62N	170	62	750	Црна	50	3x6	600
	SL200H33C	200	33	600	Кристална	50	3x3	450
	SL200H33N	200	33	600	Црна	50	3x3	450
	SL200H66N	200	66	1000	Црна	50	3x3	450
	PLA170H16N	170x120	16		Црна	50	4x8	500
	PLA170H30N	170x120	30	370	Црна	50	4x8	500
Капаци Lids								
	Шифра Reference							
	CV110H10	110	10			75	4x4	1500
	CV110H30	110	30			75	4x4	1500
	CV130H20	130	20			75	3x7	750
	CV170H20	170	20			50	3x6	600
	CV170H30	170	30			50	3x6	600
	CV200H10	200	10			50	3x3	450
	CV200H30	200	30			50	3x3	450
	CV170H20SP	170	20	spork		50	4x3	600
	CVPLA170H10	170x120	10			50	4x8	500
	CVPLA170H25	170x120	25			50	4x8	500





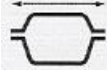
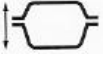













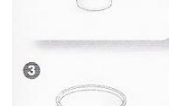

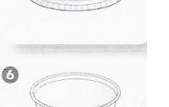

РАТИРАК		Специјално пакување за јајца Special pack for quail eggs				
	Шифра Reference					
	B118AL	191x115	35	X18	3x4	600

ТРАИРАК		Пити Pies					
	Шифра References						
	XBP200	245x245	215	25	3x4	210	
	XG205	245x245	210	50	3x4	210	
2 Пити 2 Pies							
	Шифра References						
	XB2P140	307x162	2xØ135	25	2x6	160	
Фестони Scallops							
	Шифра References						
	XB1CSJ	153x150	X1	50	2x6	300	
	XB2CSJ	282x153	X2	50	2x6	200	
Парчиња месо Sliced meats							
 <div style="display: flex; align-items: center; margin-top: 10px;">  <div style="margin-left: 5px;"> <p>option cash & carry</p> </div> </div> <div style="display: flex; align-items: center; margin-top: 10px;">  <div style="margin-left: 5px;"> <p>lid anti-mist</p> </div> </div>	Шифра References						
	BЈАН21	220x165	210x155	20		3x4	300
	BЈАН35	220x165	200x145	35	45	3x4	250
	BЈАН50	220x165	200x140	50		3x4	250

АСТИРАСК		Рамни капаци за кутии за пица Clear lids for pizza box						
	Шифра References							
	1	19DXP	233	Ø180	10		3x4	210
		22DXP	285	Ø220	10		2x6	180
		26DXP	327	Ø260	10		3x3	160
		29DXP	337	Ø285	10		3x5	120
		50DXP	560	Ø500	35		2x5	50
	2	502DXP	557x308	1/2 Ø500	16		2x6	100
	3	508DXP	309x252	1/8 Ø500	16		3x4	280
	Основи за пица Pizza bases							
		Шифра References						
4	19DX10	220	Ø180	20	Кристална	9x6	210	
	22DX10P	269	Ø220	20	Кристална	6x7	180	
	26DX10ST	300	Ø255	20	Кристална	6x5	160	
	29DX10P	326	Ø285	20	Кристална	6x5	120	
	19DX30	220	Ø180	20	Кристална	9x6	210	
	26DX30ST	300	Ø255	20	Кристална	6x5	160	
	50DX30	550	Ø500	20	Црна	2x6	50	
5	502DX30	545x298	1/2 Ø500	20	Црна	2x6	100	
6	508DX30	297x146	1/8 Ø500	20	Црна	3x5	280	

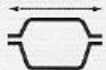
МОУЛИРАСК		Мазен кристален калап Smooth crystal mould				
	Шифра References					
	OGI (1)	86x66	34	90	4x6	4500
	TIMB (2)	78	36	80	8x8	1800
	AIGC (3)	149x49	32	125	3x8	1400

DELIPACK	Бел сад за кремасти производи White cream pots						
  	Шифра References						
	PCB250	95	76+10	250	50	6x3	500A
	PCB500	116	80+10	500	40	4x3	440

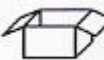
DELIPACK	Сад за сос Sauce pots								
             	Шифра Reference				Боја Color				
	1	PO37T	62	25	37	Прозирен	250	4x4	5000
	2	PO60T	62	43	60	Прозирен	250	7x4	2500
	3	COV60T	63				100	6x6	2500
	4	PO75C	70	40	90	Кристално	100	6x3	3000
		PO75B	70	40	90	Бело	100	5x4	4000
	5	PO100C	67	53	100	Кристално	100	6x3	3000
		PO100B	67	53	100	Бело	100	6x3	3000
		PO125C	67	63	125	Кристално	100	6x3	3000
		PO125B	67	63	125	Бело	100	6x3	3000
	6	COP70C	73				100	4x5	300
	Кристален сад за сос Cristal sauce pots								
		Шифра Reference				Боја Color			
	1	PO35C	45	40	37	Кристално	250	10x3	5000
2	CVPO35C	47			Кристално	100	6x5	5000	
3	PO55C	63	31	59	Кристално	250	6x5	2500	
4	CVPO70C	66			Кристално	100	6x5	2500	
5	PO90C	75	37	96	Кристално	250	6x4	2500	
6	PO115C	75	49	118	Кристално	250	6x5	2500	
7	PO160C	75	52	163	Кристално	250	5x3	2500	
8	CVPO160C	77	40	37	Кристално	100	6x4	2500	

		Кружни лончиња (-40/+70) Round pots (-40/+70)						
	Шифра Reference				Боја Color			
	1 PO230C	117	45	237	Кристално	25	6x3	500
	2 PO350C	117	61	355	Кристално	25	4x4	500
	3 PO470C	117	78	473	Кристално	25	4x4	500
	4 PO700C	117	110	710	Кристално	25	4x4	500
	5 PO940C	117	146	946	Кристално	25	4x4	500
	6 CVPO940C	122			Кристално	25	6x4	500

CAISSIPACK		Прозирен сад за храна Translucent food containers						
	Шифра Reference							
	BTFP40	63x63	25	40	500	4x8	9000	
	BTFP75	75x65	30	75	500	5x7	6000	
	BT100TFP	92x62	32	100	500	4x9	6000	
	BTFP125	91x71	35	125	500	4x9	5000	
	BT150TFP	113x67	34	150	500	4x8	6000	
	BT200	112x88	33	200	500	4x10	3000	
	B250T	111x87	42	250	500	4x10	3000	
	BT375	138x90	46	375	250	4x9	2500	
	BT500	143x111	49	500	250	5x8	1500	
	BTFP500	143x111	49	500	250	5x8	1500	
	B750T	176x116	49	700	250	4x10	1250	
	BT1000	189x144	54	1000	250	6x7	1000	
	B1500T	202x152	62	1400	250	4x5	1000	
	B2000T	215x196	67	2000	250	4x4	1000	
	BT3000	248x213	88	3000	100	6x7	200	
		Бел сад за храна White food containers						
	Шифра Reference							
	BP1B	241x85	34	1 pied	250	4x8	2000	
	BP2B	271x103	49	2 pieds	250	4x6	1500	
	BBFP125	91x71	35	125	250	4x9	5000	
	BBFP250	111x87	42	250	250	4x8	3000	
	BBFP375	138x90	46	375	250	4x9	2500	









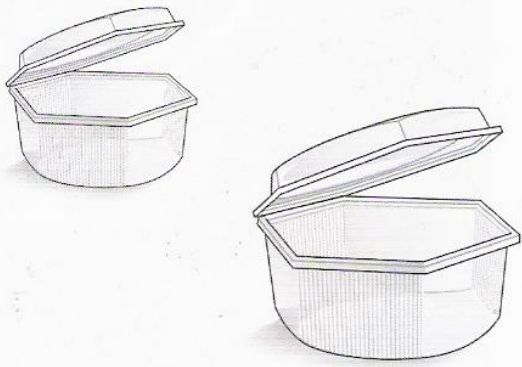
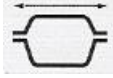
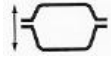

	BBFP500	143x111	49	500	250	5x8	1500
--	---------	---------	----	-----	-----	-----	------





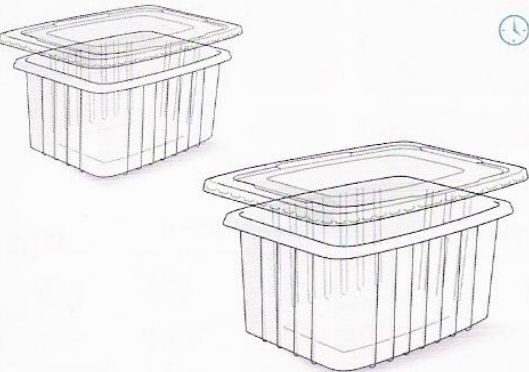
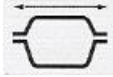
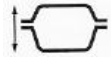



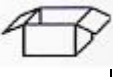

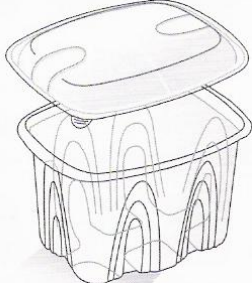
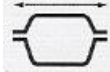
САДОВИ И ПОСЛУЖАВНИЦИ ЗА ТОПЛА УПОТРЕБА

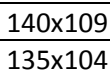

ONDIPACK	Микробранови кутии Microwaveable hinged packs in cash and carry bags						
	Шифра Reference						
	OK250	120x113	48	250	50	3x4	900
	OK375	120x113	70	375	50	3x4	900
	OK500	140x122	68	500	50	4x3	600
	OK750	140x122	103	750	50	3x3	600
	OK600	185x135	50	600	50	4x3	300
	OK800	185x133	64	800	50	4x3	300
	OK1050	185x135	86	1050	50	4x3	300
	OK760	190x183	50	750	50	4x3	300
	OK1200	190x183	70	1200	50	4x3	300
	OK1500	190x183	85	1500	50	3x3	300
	OK1800	190x183	100	1800	50	3x3	300
	OK1550	223x292	46	1500	40	5x8	40
	OK15502C	223x292	46	1400	40	5x8	40
	OK15503C	223x292	46	1350	40	5x8	40
	OK2500	223x292	71	2500	30	5x8	30
	Микробранови кутии Microwaveable hinged packs						
	Шифра Reference						
OK251	120x113	48	250		3x4	900	
OK371	120x113	70	375		3x4	900	
OK501	140x122	68	500		4x3	600	
OK801	185x133	64	800		4x3	300	
OK1051	185x135	86	1050		4x3	300	
OK1501	190x183	85	1500		3x3	300	

ALPHATOP MICRO	Микробранови кутии Microwaveable hinged packs						
	Шифра Reference				кеца		
	ATO125TP	110	50	125	50	4x5	600
	ATO250TP	133	55	250	50	4x3	600
	ATO376TP	150	68	375	50	4x5	300
	ATO502TP	150	82	500	50	4x4	300
	ATO752TP	180	83	750	50	3x4	300
	AT1002TP	180	100	1000	50	4x3	300
	AT1501TP	225	97	1500	25	4x3	150
	AT2001TP	235	98	2000	25	4x3	150

PACK CHALEUR	Микробранова основа и капак Microwaveable base and lid						
	Шифра Reference						
	BCPPO300	138x98	35	300	25	4x4	500
	BCPPO450	138x98	66	450	25	4x4	500
	BCPPO605	138x98	83	600	25	4x4	500
	BCPPO600	195x140	35	600	25	4x5	200
	BCPPO900	195x140	50	900	25	4x5	200
	BCPP1200	195x140	65	1200	25	4x5	200
	BCPP1500	195x140	79	1500	25	4x5	200
	BCPP1800	195x140	98	1800	25	4x5	200

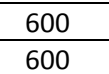
ARCHIPACK	Микробранова основа и капак Microwaveable base and lid						
	Шифра Reference						
	BCKTP251	143x115	46	250	30	4x4	480
	BCKTP371	143x115	60	375	30	4x4	480
	BCKTP501	143x115	75	500	30	4x4	480
	BCKTP751	185x145	69	750	30	3x3	480
	BCKTP1001	185x145	85	1000	30	3x3	480
	BCKTP1501	185x145	122	1500	30	3x3	480
	BCKTP1051	233x183	68	1050	30	4x4	180
	BCKTP1551	233x183	87	1500	30	4x4	180
	BCKTP2001	233x183	106	2000	30	4x4	180
	BCKTP2501	233x183	129	2500	30	4x4	180
	BCKNP371	143x115	60	375	30	4x4	480
	BCKNP501	143x115	75	500	30	4x4	480
	BCKNP751	185x145	69	750	30	3x3	480
	BCKNP1001	185x145	85	1000	30	3x3	480
	Шифра Reference						
	BCK250TP	140x109	33	250	100	3x7	600
	BCK375TP	140x109	47	375	100	3x7	600
	BCK500TP	140x109	62	500	100	3x7	600
	COVBCK1H20	135x104	15		100	6x7	600
	BCK750TP	180x140	54	750	100	4x5	400
	BCK1000TP	180x140	70	1000	100	4x5	400
	BCK1500TP	180x140	105	1500	100	4x5	400
	COVBCK2H20	176x136	15		100	4x9	400

MARMIPACK



Микробранови основи, црни Microwaveable bases, black

Шифра Reference					
FMA0501D	218x140	43	500	2x8	380
FMA1000F	254x187	48	1000	3x7	200
FMA1500F	254x187	68	1500	4x4	200
FMA1800F	254x187	80	1800	4x4	200
FMA2C1000F	254x187	48	550/350	3x7	200

Микробранови капаци Microwaveable lids

Шифра Reference					
CMA0501D	195X130	24		4X5	380
CMA1000F	230X180	28		4X6	200
CMA0501DA	195X130	24		4X5	380
CMA1000FA	230X180	28		4X6	200

Купола за кокошка со спојување со рачки Chicken dome with clip on handles

Шифра Reference					
CLMA1000F	255X187	77		3X7	200

Црна основа и прозирен капак Black base and translucent lid

Шифра Reference						
MA500N	218x140	58	500	25	4x4	200
MA0900N	230x163	60	900	25	4x5	125
MA1000N	254x187	68	1000	25	3x4	200
MA1500N	254x187	88	1500	25	3x4	200
MA1800N	254x187	101	1800	25	3x4	200
MA2C1000N	254x187	68	550/350	25	3x4	200

AVIPACK

**Основа и капак за пакување на пилешко
Base and lid poultry pack**



Шифра Reference						
AV128NK	176x163	34			4x11	180
AV145NK	176x163	50			4x11	180
Шифра Reference						
AV135AT	176x163	36			4x11	180
AV165	176x163	66			4x11	180

**Кутија за топло пиле, црна основа и прозирен капак
Hot chicken box, black base and translucent lid**

Шифра Reference						
AV6	264x201	116	1725	65	4x4	260

PRESTIPACK

Основи и капаци

Bases and lids packed together

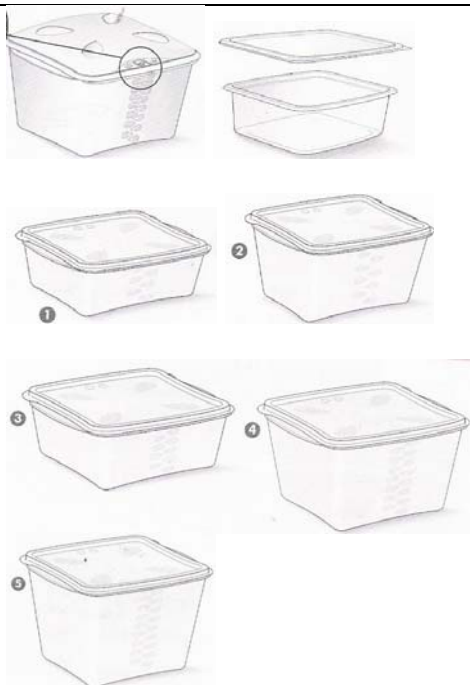

Шифра Reference						
BCS600GD	157x130	70	600	50	3x5	250
BCS900	157x130	96	900	50	3x5	250
BCS1000GD	177x159	81	1000	50	4x4	300
BCS1500GD	177x159	112	1500	50	4x4	200
BCS1800GD	177x159	135	1800	50	4x4	200

Bases with re-entering lid

Шифра Reference						
RC300	115x95	41	300	50	4x4	600
RC450	115x95	65	450	50	4x4	600
BC600	158x130	55	600/680	30	3x4	450
BC900	158x130	95	900/980	30	3x4	450
BC1000	175x159	85	1000/1110	30	4x4	240
BC1500	175x159	117	1500	30	4x4	240
BC1800	175x159	137	1800/1910	30	4x4	240

SERVIPACK

Sealable bowls and translucent lids

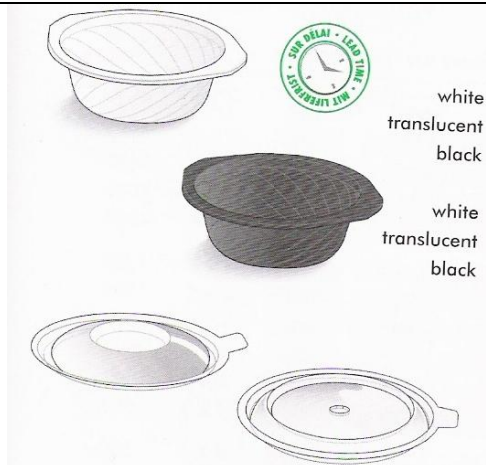

white
translucent
black

white
translucent
black

Шифра Reference						
BOL400	144	53	400	100	4x4	600
BOL400T	144	53	400	100	4x5	600
BOL400N	144	53	400	100	4x5	600
BOL500	163	59	550	100	4x4	600
BOL500T	163	59	550	100	4x4	600
BOL500N	163	59	550	100	4x4	600
COVB350	131	18	BOL 400-T-N	100	4x8	600
COVB350TR	131	10	BOL 400-T-N	100	4x8	600
COVB500	146	27	BOL 500-T-N	100	4x4	600
COVB500TR	146	10	BOL 500-T-N	100	4x4	600

White sealable plates

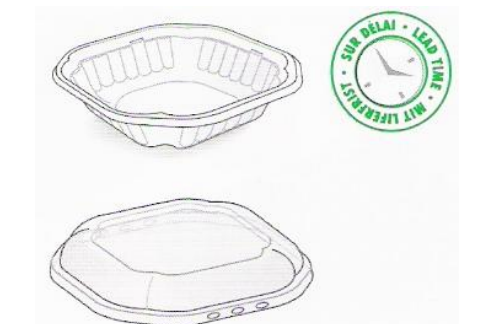

Шифра Reference						
AC160H35BP	163x163	37,5		150	5x6	600
AC160H35N	163x163	37,5		150	5x6	600
AC160H45BP	163x163	47,5		150	5x6	600

Прозирен капак Translucent lid

COVAC160	170x170	26		50	3x6	600
----------	---------	----	--	----	-----	-----

RONDOPACK

Sealable plates

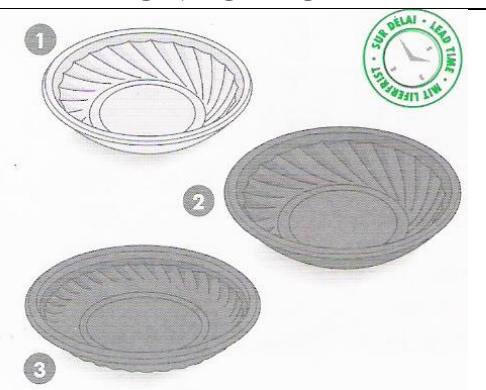





Шифра Reference						
ASC170PPB	170	35	Бела	70	3x6	560
ASC170PPT	170	35	Прозирна	70	3x6	560
ASC170PPN	170	35	Црна	70	3x6	560
ASC220PPB	220	43	Бела	70	3x8	210
ASC220PPT	220	43	Прозирна	70	3x8	210
ASC220PPN	220	43	Црна	70	3x8	210
ASP220PPB	220	22,5	Бела	70	3x8	210
ASP220PPN	220	22,5	црна	70	3x8	210





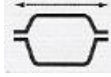
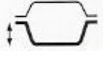

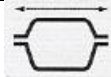
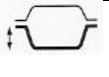

Прозирен капак Translucent lid

CVASC170H05	170	5		70	3x7	560
-------------	-----	---	--	----	-----	-----

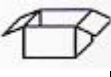
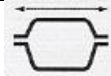

	CVASC170H25	170	25		70	3x7	560
	CVASC220H05	220	5		70	3x8	210
	CVASC220H25	220	27		70	3x8	210
	CVASC170H25C	170	25		70	3x7	560
	CVASC220H30C	220	30		70	6x4	210



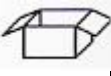

ALPHACEL 	Translucent sealable						
	Шифра Reference						
	CL180TP	137x96	23	170	100	4x5	1800
	CL250TP	137x96	32	250	100	4x5	2400
	CL375TP	137x96	49	370	100	4x4	2000
	CL500TP	137x96	66	480	100	4x4	1600
	CL650TP	192x137	35	650	100	4x5	1200
	CL750TP	192x137	40	730	100	4x5	1200
	CL1000TPP	192x137	55	970	100	4x5	900
	CLTP1200	192x137	70	1200	100	4x5	900
	CLTP1500	192x137	86	1440	100	3x3	800
	CLTP2000	192x137	100	1800	100	4x3	600
	CLTP2300	200x154	110	2300	50	4x3	500
	Прозирен капак Translucent lid						
	CVTP500	148x106	12		50	3x3	1400
	COV1500TP	192x137	12		50	3x3	800
	Translucent sealable (small size)						
	Шифра Reference						
	MCL125TP (1)	113x88	21	125	300	4x8	2400
	MCL210TP (2)	113x88	35	200	200	4x8	1600
	MCL310TP (3)	113x88	56	300	200	4x5	1600
	Translucent sealable (medium size)						
	Шифра Reference						
	MCL510TP (4)	177x113	37	500	150	4x8	900
	MCL760TP (5)	177x113	57	750	100	4x8	600
	MCL910TP (6)	177x113	71	900	100	4x8	600

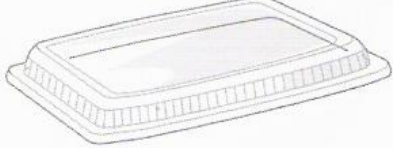
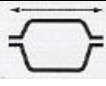
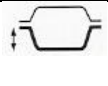
	Translucent sealable (large size)						
	Шифра Reference						
	MCL1010TP	227x177	33	1000	150	4x8	450
	MCL1010TP2 (7)	227x177	33	600-300	150	4x8	450
	MCL1510TP	227x177	50	1500	100	4x8	400
MCL2010TP (8)	227x177	68	2000	100	4x8	300	

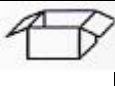
GASTROPACK 	White sealable						
	Шифра Reference						
GN8H35	160x130	35	440	100	4x6	800	
GN8H42	160x130	42	500	100	5x6	800	
GN6H40	176x163	40	750	100	5x6	400	
GN6H402C	176x163	40	2x327	100	5x6	400	
GN6H46	176x163	46	850	100	5x6	400	
GN1/4H40	263x162	40	900	90	4x6	360	
GN1/4H45	263x162	45	1250	85	4x6	340	
GN1/4H55	263x162	55	1500	75	4x6	340	
GN1/4H75	263x162	75	2000	75	4x6	300	
GN1/3H48	323x174	48	1750	75	4x6	225	
GN1/2H48	325x265	48	3000	75	4x6	150	
GN1/2H52	325x265	52	3200	75	4x6	150	
GN1/2H60	325x265	60	3700	70	4x6	140	
GN1/2H70	325x265	70	4200	70	4x6	140	
GN1/2H80	325x265	80	4700	65	4x6	130	
GN1H52	534x325	52	6200	15	4x3	60	
White sealable -10/+80							
Шифра Reference							
GN8L35	160x130	35	440	100	4x6	800	
GN8L42	160x130	42	500	100	4x6	800	
GN1/4L40	263x162	40	900	100	4x6	400	
GN1/4L45	263x162	45	1250	95	4x6	380	
GN1/4L55	263x162	55	1500	90	4x6	360	
GN1/4L75	263x162	75	2000	85	4x6	340	
GN1/3L48	323x174	48	1750	90	4x6	270	
GN1/2L48	325x265	48	3000	85	4x6	160	
GN1/2L52	325x265	52	3200	80	4x6	160	
GN1/2L60	325x265	60	3700	80	4x6	160	

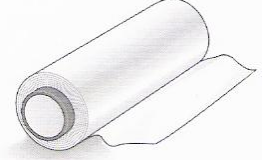









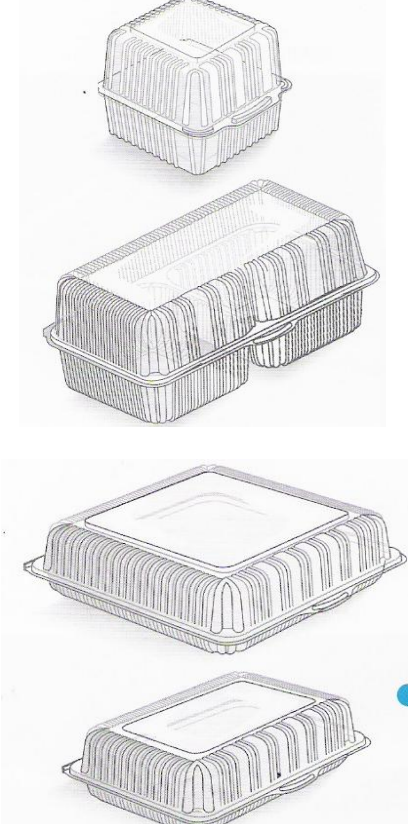





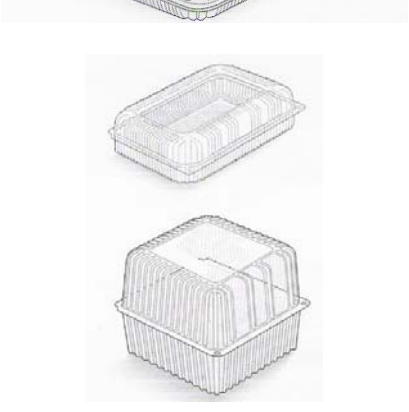

	GN1/2L70	325x265	70	4200	80	4x6	160	
	GN1/2L80	325x265	80	4700	75	4x6	150	
	Прозирни капаци Translucent lids							
	Шифра Reference							
	COV8T	164x134	25		100	4x6	400	
	COV4T	268x166	32		90	4x3	360	
COV2	330x272	32		35	4x3	140		





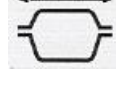

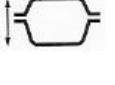

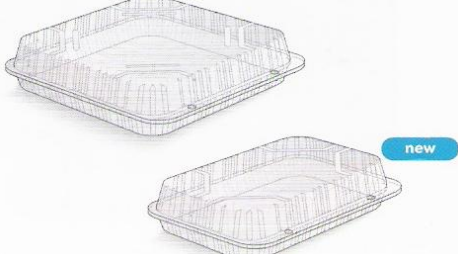

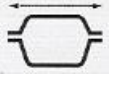
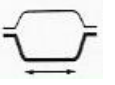
FILIPACK	Фолија за пакување Sealing film					
	Шифра Reference	mm	μ			
	OPRPP40/150/500	150	40	500	24x7	1
	OPRPP40/160/500	160	40	500	24x6	1



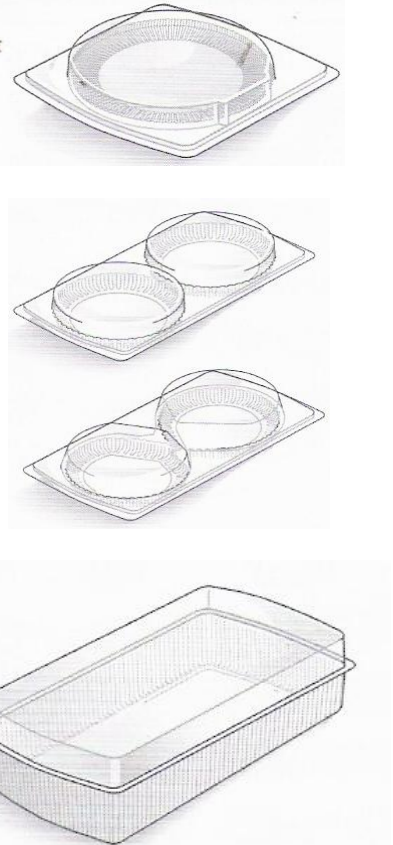
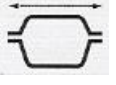
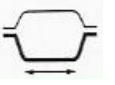

ПЕКАРСКИ ПРОИЗВОДИ BAKERY

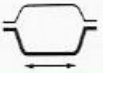
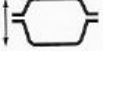



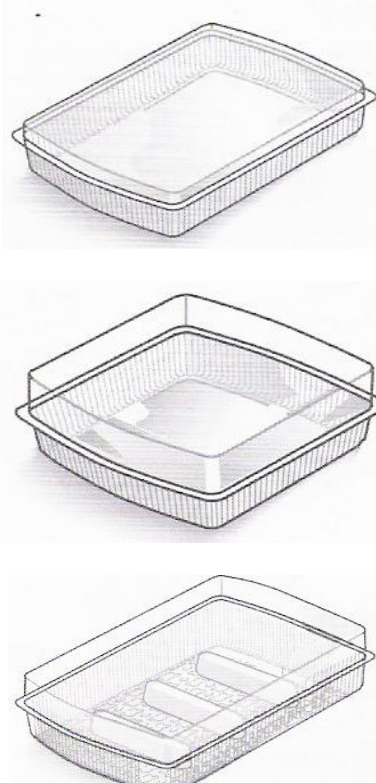
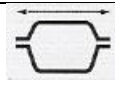
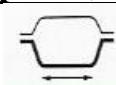

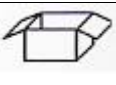
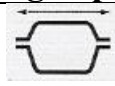
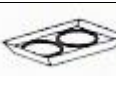
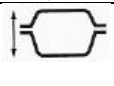

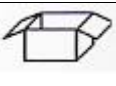
TOUTIPACK	Сад за пекарски производи со рачка, лесно затворање Bakery container with handle, easy closure and air tight seal					
	Шифра Reference					
	TV02H55	224x155	190x105	55	2x4	440
	TV02H80	224x155	190x105	80	2x4	400
	TV04	215x172	165x135	80	3x4	280
	TV06	215x172	165x135	120	3x4	260
	TV10	238x205	175x160	150	2x4	300
	TV15	288x276	235x230	120	2x6	140
	TV20	288x276	235x230	150	2x6	140
	TV206	216x325	2x(160x130)	120	3x4	140
	TV210	340x239	2x(175x160)	150	3x4	140
	TV2,5	288x276	240x235	80	2x6	140
	TV3	333x314	280x280	80	3x3	120
	TV11	250x182	215x130	80	2x7	210
	TV11H50	250x182	215x130	50	2x7	210
	TV11H65	250x182	215x130	65	2x7	210
	TV11H100	250x182	215x130	100	2x7	210
	TV11,5	270x207	235x155	80	3x7	140
	TV11,5H35	270x207	235x155	35	3x7	150
	TV11,5H55	270x207	235x155	55	3x7	150
	TV11,5H100	270x207	235x155	100	3x7	140
Ventilated hinged packs						
	Шифра Reference					
	TO1912H55	208x140	180x115	55	2x4	680
	TO1912H75	208x140	180x115	75	2x4	680
	TO04C	195x160	165x135	80	3x4	420
	TO06C	195x160	165x135	120	3x4	390
	TO09C	213x195	185x165	120	3x4	300
	TO10C	213x195	185x165	150	3x4	300
	TO15P	270x260	230x230	120	2x3	150
	TO20C	270x260	230x230	150	2x3	150
	TO206	311x200	2x(160x130)	120	2x6	150
	TO210	387x220	2x(180x160)	150	2x4	150

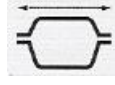
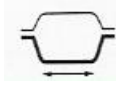
PATIPACK	Ventilated hinged packs					
	Шифра Reference					
	11BC80	235x165	205x130	80	3x4	300
	11,5BC80	257x190	230x150	80	2x7	250
	2BC65	240x232	210x210	65	3x4	210
	2,5BC80	273x263	235x235	80	2x7	130
	3BC80	315x310	275x275	80	2x6	110

TRAITIPACK	Flat packs, air tight seal					
	Шифра Reference					
	XBP200	245x245	215	25	3x4	210
	XG205	245x245	210	50	3x4	210
	Flat packs with cavities, air tight seal					
	Шифра Reference					
	XB2P140	307x162	2xØ135	25	2x6	160
	XB1CSJ	153x150	x1	50	2x6	300
	XB2CSJ	282x153	x2	50	2x6	200
	Flat packs, air tight seal					
	Шифра Reference					
	X9H50	186x137	155x100	50	2x7	360
X9H80	185x137	155x100	80	2x7	360	
X10H65	206x115	170x80	65	3x4	240	
X10H80	205x115	170x80	80	3x4	240	
X10,5H80	261x130	225x90	80	2x7	200	
X11H55	264x178	230x140	55	3x7	110	
X11H80	264x178	230x140	80	3x7	110	
X11H100	264x178	230x140	100	3x7	110	
X11,9H65	301x233	255x190	65	3x4	100	
X11,5H60	280x190	240x155	60	3x3	200	
X11,5H100	280x190	240x155	100	3x3	200	
X12H40	313x196	280x165	40	3x5	150	
X12H55	313x196	280x165	55	3x5	150	
X12H100	313x196	280x165	100	3x5	130	
X15H40	354x255	310x215	40	3x4	125	
X15H80	354x255	310x215	80	3x4	125	

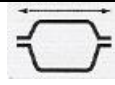
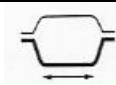

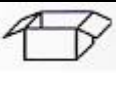

	X13H110	364x200	315x155	110	3x5	100
	Flat packs, air tight seal					
	Шифра Reference					
	X0,5H50	135x135	110x110	50	3x7	360
	X0,5H70	135x135	110x110	80	3x7	360
	X0,9H65	209x205	170x170	65	3x4	180
	X1H50	217x217	180x180	50	3x4	150
	X1,5H65	225x215	180x180	65	3x4	150
	X1,5H80	225x215	180x180	80	3x4	150
	X1,5H95	225x215	180x180	95	3x4	150
	X2H65	250x243	210x210	65	3x4	180
	Hinged packs with cavities, air tight seal					
	Шифра Reference					
	X0,9B3E	209x205	X3(170x50)	50	3x4	180
	XB4DO	205x155	180x130	80	2x6	300
XB4E	280x192	X4(155x50)	55	3x3	200	
X10,5B4E	262x127	X4(100x45)	50	2x7	220	
X15B24PF	354x255	X24	50	3x4	125	
X11H60AL	264x178	6x(Ø60)	60	3x7	110	





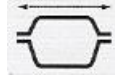

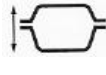
TRAITIPACK P 	Square, flat packs, air tight seal					
	Шифра Reference					
	X0,9H65P	209x205	170x170	65	3x4	150
	X1,5H45P	225x215	180x180	45	3x4	150
	X1,5H55P	225x215	180x180	65	3x4	150
	X2H65P	250x243	210x210	65	3x4	150
	X2,5H45P	265x255	Ø220	45	2x7	120
	X2,5H55P	265x255	Ø220	55	2x7	120
	Rectangular, flat packs, air tight seal					
	Шифра Reference					
	X9H65P	186x137	155x100	65	2x7	360
	X10H40P	205x115	170x80	40	3x4	240
	X10H60P	205x155	170x80	60	3x4	240
	X10H80P	205x115	170x80	80	3x4	240
	X11,5H40P	280x190	240x155	40	3x3	200
Hinged packs with cavities, air tight seal						

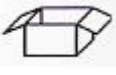
EL

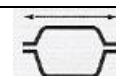
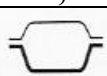
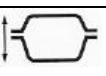
News

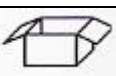
Електролюкс
Electrolux
Macedonia
Palenzo

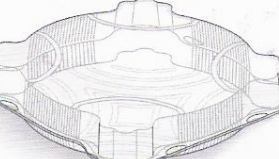
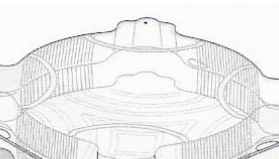
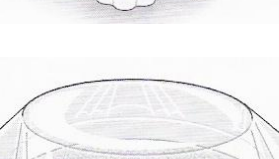
	Шифра Reference					
	X9H65ALP	186x137	2x(110x75)	65	2x7	360
	X9H452EP	186x137	2x(160x35)	45	2x7	360
	X0,9H454EP	209x205	4x(140x35)	45		

ПАТИПАК	Round, flat packs					
	Шифра Reference					
	G190	200x200	175	50	3x4	320
	G230	250x250	225	50	3x4	240
	G220R (1)	265x265	215	50	2x7	130
	G250	260x260	235	50	2x7	160
	G290	300x300	275	50	2x6	130
	190BG50	222x220	190	50	3x4	210
	190BG65P	222x220	190	65	3x4	210
	215BG50	233x231	200	50	3x4	210
	215BG65P	233x231	200	65	3x4	210
	235BG50	255x253	225	50	3x4	210
	235BG65P	255x253	225	65	3x4	210
	245BG35	264x262	230	35	2x7	130
	245BG50	264x262	230	50	2x7	130
	245BG65P	264x262	230	65	2x7	130
	285BG50	304x301	270	50	2x6	110
	285BG65P	304x301	270	65	2x6	110
	295BG50	308x307	275	50	2x6	110
	295BG65P	308x307	275	65	2x6	110
	190BG80	222x220	190	80	3x4	210
	190BG100	222x220	190	100	3x4	210
	215BG80	233x231	200	80	3x4	210
	215BG100	233x231	200	100	3x4	210
	235BG80	255x253	225	80	3x4	210
	235BG100	255x253	225	100	3x4	210
	245BG80	264x262	230	80	2x7	130
	245BG100	264x262	230	100	2x7	130
	285BG80	304x301	270	80	2x6	110
	285BG100	304x301	270	100	2x6	110
	295BG80	308x307	275	80	2x6	110
	295BG100	308x307	275	100	2x6	110
	305BG80	337x337	300	80	2x6	100
	305BG100	337x337	300	100	2x6	100

Electrolux Macedonia
Bitola/Europe
+389(0)47 203 330

www.electrolux.mk www.elektroluks.mk www.elektroluks.eu
electrolux@t-home.mk elektroluks@t-home.mk

EL

News

Електролюкс
Electrolux
Macedonia
Palenzo

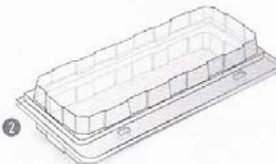
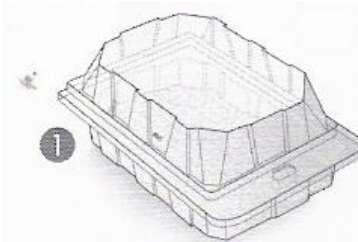
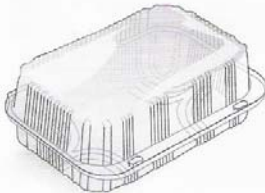
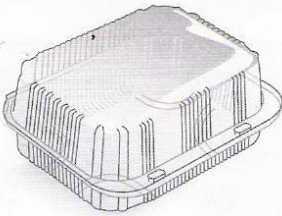
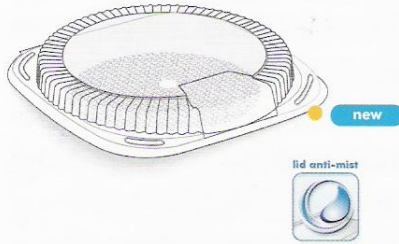

G185H80	210x203	175	80	3x4	240
G215H80	240x230	200	80	3x4	210
G215H100	240x230	200	100	3x4	210
G235H80	255x250	220	80	3x4	210
G235H100	255x250	220	100	3x4	210
G245H80	270x260	230	80	2x7	130
G245H100	270x260	230	100	2x7	130

Hinged pack

Шифра Reference					
XG194	215x215	185	50	3x4	210
XG214	235x235	205	50	3x4	210
XG214H25					
XG234	255x255	220	50	3x4	210
XG244	265x265	235	50	2x7	160
XG294	305x305	275	50	2x6	120

Hinged packs, air tight seal

Шифра Reference					
T125H50	165x155	125	50	3x4	405

Rectangular hinged packs

Шифра Reference					
9BP65	165x135	140x100	65	3x7	300
9BP80	165x135	140x100	80	3x7	300
10,1BP65	204x120	180x85	65	3x4	420
10,1BP90	204x120	180x85	90	3x4	420
10BP50	191x115	165x85	50	3x4	600
10BP65	191x115	165x85	65	3x4	600
10BP80	191x115	165x85	80	3x4	600
10BP100	191x115	165x85	100	3x4	600
B3BP	200x172	165x145	50	3x4	390
10,2BP50	216x125	190x95	50	3x4	420
10,2BP65	216x125	190x95	65	3x4	420
10,2BP80	216x125	190x95	80	3x4	420
10,2BP100	216x125	190x95	100	3x4	420
11BP50	234x165	210x130	50	3x4	300
11BP65	234x165	210x130	65	3x4	300
11BP80	234x165	210x130	80	3x4	300
11BP100	234x165	210x130	100	3x4	300
11,5BP55	258x190	230x150	55	2x7	200
11,5BP80	258x190	230x150	80	2x7	200
11,5BP100	258x190	230x150	100	2x7	200

Electrolux Macedonia
Bitola/Europe
+389(0)47 203 330

www.electrolux.mk www.elektroluks.mk www.elektroluks.eu
electrolux@t-home.mk elektroluks@t-home.mk

EL

News

ΕΛΛΗΜΕΤΑΛΟΥΣ
Electrolux
Macedonia
Palenzo

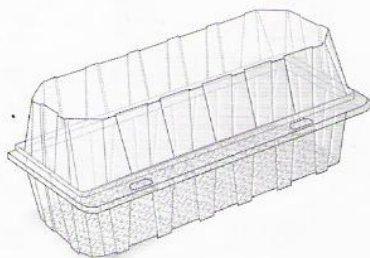
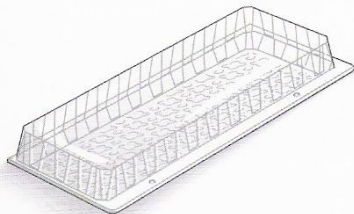
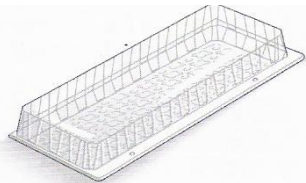
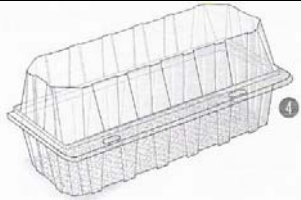

112BP65	268x155	240x120	65	2x6	280
112BP80	268x155	240x120	80	2x6	280
112BP100	268x155	240x120	100	2x6	280
12BP55	294x205	265x165	55	4x4	150
12BP65	294x205	265x165	65	4x4	150
12BP80	294x205	265x165	80	4x4	150
12BP100	294x205	265x165	100	4x4	150
12BP150	294x205	265x165	150	3x4	150
12,5BP100	313x200	280x165	100	3x4	150
BF32BP	350x153	325x115	50	3x5	160
6H50 (1)	130x80	100x60	50	3x7	800
8H40 (2)	191x90	170x60	40	3x5	600
9H50 (3)	165x135	145x105	50	3x7	300
9H65	165x135	145x105	65	3x7	300
9H80	165x135	145x105	80	3x7	300
10H50	191x115	170x85	50	3x4	600
10H65	191x115	170x85	65	3x4	600
10H80	191x115	170x85	80	3x4	600
10H100	191x115	170x85	100	3x4	600
B3R	200x170	170x150	50	3x4	390
10,2H50	216x125	195x95	50	3x4	420
10,2H65	216x125	195x95	65	3x4	420
10,2H90	216x125	195x95	90	3x4	420
10,5H50	252x117	230x85	50	2x7	300
10,5H65	252x117	230x85	65	2x7	300
10,5H85	252x117	230x85	85	2x7	300
10,5H100 (4)	252x117	230x85	100	2x7	300
11H55	235x165	210x130	55	3x4	300
11H80	235x165	210x130	80	3x4	300
11H100	235x165	210x130	100	3x4	300
11,5H55	257x190	235x155	55	2x7	200
11,5H100	257x190	235x155	100	2x7	200
112H55	268x155	245x125	55	2x6	260
112H80	268x155	245x125	80	2x6	260
112H100	268x155	245x125	100	2x6	260
12H55	293x200	270x170	55	4x4	150
12H80	293x200	270x170	80	4x4	150
13H55	343x190	320x160	55	4x5	150
13H100	343x190	320x160	100	4x5	150
B3CSJFP	388x145	365x110	50	3x6	150
B32H80	343x137	315x105	80	3x7	150
B32	343x137	315x105	100	3x7	150
B22SB50	242x137	220x105	50	4x7	150
B22SB65	242x137	220x105	65	4x7	150
B22SB	242x137	220x105	80	4x7	150
B22	242x137	220x105	100	4x7	150





Square hinged packs



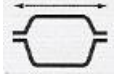

Шифра Reference					
0,5H35	130x120	100x100	35	3x7	405
0,5H50	130x120	100x100	50	3x7	405
0,5H70	130x120	100x100	70	3x7	405
0,5H80	130x120	100x100	80	3x7	405
0,5H90	130x120	100x100	90	3x7	405
1H50	200x192	170x170	50	3x5	300
1H65	200x192	170x170	65	3x5	300
1H80	200x192	170x170	80	3x5	300
1H100	200x192	170x170	100	3x5	300
1,5H50	227x220	195x195	50	3x4	225
1,5H65	227x220	195x195	65	3x4	225
1,5H80	227x220	195x195	80	3x4	225
1,5H100	227x220	195x195	100	3x4	225
2H50	240x232	210x210	50	3x4	210
2H65	240x232	210x210	65	3x4	210
2H80	240x232	210x210	80	3x4	210
2H100	240x232	210x210	100	3x4	210
2,5H55	272x263	235x235	55	2x7	130
2,5H80	272x263	235x235	80	2x7	130
2,5H100	272x263	235x235	100	2x7	130
3,5H60	364x355	320x320	60	2x5	100
3,5H100	364x355	320x320	100	2x5	100
3,5H150	364x355	320x320	150	2x5	100
1BP50	200x190	165x165	50	3x5	300
1BP65	200x190	165x165	65	3x5	300
1BP80	200x190	165x165	80	3x5	300
1BP100	200x190	165x165	100	3x5	300
1,2BP50	217x207	180x180	50	3x4	225
1,2BP60	217x207	180x180	60	3x4	225
1,5BP50	230x223	190x190	50	3x4	225
1,5BP65	230x223	190x190	65	3x4	225
1,5BP80	230x223	190x190	80	3x4	225
1,5BP100	230x223	190x190	100	3x4	225
2BP50	240x233	205x205	50	3x4	210
2BP65	240x233	205x205	65	3x4	210
2BP80	240x233	205x205	80	3x4	210
2BP100	240x233	205x205	100	3x4	210
2,5BP65	272x263	235x235	65	2x7	130
2,5BP80	272x263	235x235	80	2x7	130
2,5BP100	272x263	235x235	100	2x7	130
3BP65	320x310	270x270	65	2x6	120
3BP80	320x310	270x270	80	2x6	110

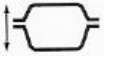
EL

News

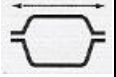
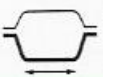
Ελεγκόμενος
Electrolux
Macedonia
Palenzo

3BP100	320x310	270x270	100	2x6	110
Rectangular hinged packs					
Шифра Reference					
10H65AL	191x115	2xØ70	65	3x4	600
B22AL	242x140	2xØ90	65	4x7	150
B22CSJ	243x140	2xØ90	50	4x7	200
112CSJ	267x150	2xØ100	50	2x6	260
1H50AL	198x190	4xØ70	50	3x5	300
1H90AL	200x190	4xØ70	90	3x5	300
B9M	200x190	9xØ55	60	3x5	300
B4CSJ	270x260	4xØ100	55	2x7	130
B12PF	200x190	x12	50	3x5	300
B24PF	275x260	x24	50	2x7	130
B92B	165x135	2x(105x65)	65	3x7	300
B14B65	198x191	4x(95x55)	65	3x5	300
B14B	198x191	4x(95x55)	100	3x5	300
B2E	190x115	2x(170x35)	50	3x4	600
B4E	258x188	4x(155x40)	50	2x7	200
PP150	162x135	1/8Ø260	50	4x5	440
PP150C	162x135	1/8Ø260	50	4x5	440
PP150H80P	162x135	1/8Ø260	80	4x5	440
1BP75AL	200x190	4xØ50	75	3x5	300
9BP2B	165x135	2x(100x60)	65	3x7	300
10BP2E	191x115	2x(165x35)	50	3x4	600
10BP95AL	191x115	2x Ø50	95	3x4	600
11,5BP4E	258x190	4x(150x40)	50	2x7	200
B6P	232x165	6xØ55	70	3x4	300
11H40AL2	235x165	6xØ50	95	3x7	150
B4AL	160x160	4xØ45	35	3x3	500

ACTIPACK	Round gateaux domes					
Шифра Reference						
12DX02	172	120	60		3x4	420
16DX00	213	160	30		3x5	210
16DX02	213	160	60		3x5	210
16DX03	213	160	80		3x5	210
18DX00	224	175	30		3x4	210
18DX02	224	175	60		3x4	210
18DX03	224	175	80		3x4	210
19DX00	233	180	30		3x4	210
19DX02	233	180	60		3x4	210

lid anti-mist

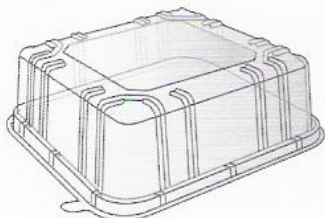
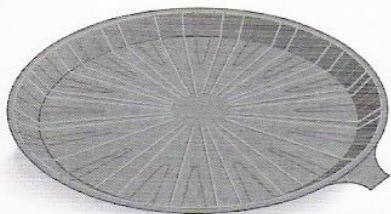
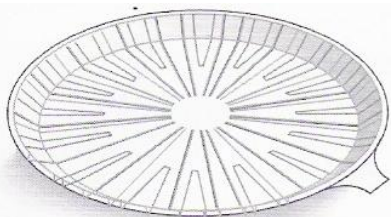
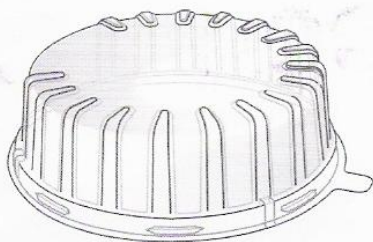

lid anti-mist



19DX03	233	180	80		3x4	210
22DX00	265	215	30		2x7	180
22DX02	265	215	60		2x7	180
22DX03	265	215	80		2x7	180
25DX00	290	240	30		2x6	160
25DX02	290	240	60		2x6	160
25DX03	290	240	80		2x6	160
26DX00	314	255	30		3x3	160
26DX02	314	255	60		3x3	160
26DX03	314	255	80		3x3	160
29DX00	337	285	30		2x6	120
29DX02	337	285	60		2x6	120
29DX03	337	285	80		2x6	120

Кружни основи
Round bases

Шифра Reference				Боја color		
12DX10	160	120	20	Кристална	7x8	420
12DX30	160	120	20	Црна	7x8	420
16DX10	199	160	20	Кристална	9x7	210
16DX30	199	160	20	Црна	9x7	210
18DX10	210	175	20	Кристална	9x6	210
18DX30	210	175	20	Црна	9x6	210
19DX10	220	180	20	Кристална	9x6	210
19DX30	220	180	20	Црна	9x6	210
22DX10	250	215	20	Кристална	6x7	180
22DX30	250	215	20	Црна	6x7	180
25DX10	277	240	20	Кристална	4x6	160
25DX30	277	240	20	Црна	4x6	160
26DX10	300	255	20	Кристална	6x5	160
26DX30	300	255	20	Црна	6x5	160
29DX10	326	285	20	Кристална	6x5	120
29DX30	326	285	20	Црна	6x5	120

Clear square gateaux domes

Шифра Reference						
1110DF01	152x142	110x100	40		3x4	630
1110DX02	152x142	110x100	60		3x4	630
1110DX03	152x142	110x100	80		3x4	630
1515DX01	213x212	170x170	40		3x4	270
1515DX02	213x212	170x170	60		3x4	270
1515DX03	213x212	170x170	80		3x4	270
1919DX01	235x235	190x190	40		3x4	300

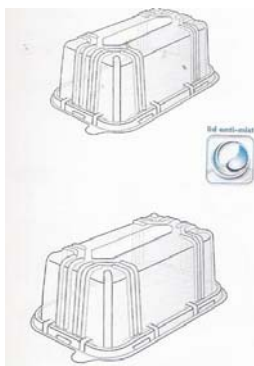
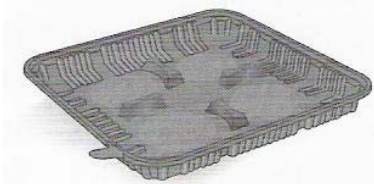
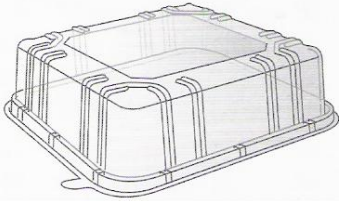

1919DX02	235x235	190x190	60		3x4	300
1919DX03	235x235	190x190	80		3x4	300
2222DX02	285x285	230x230	60		2x6	200
2222DX03	285x285	230x230	80		2x6	200
2626DX02	325x325	275x275	60		3x6	100
2626DX03	325x325	275x275	80		3x6	100

Квадратни основи Square base

Шифра Reference				Боја color		
1110DX30	142x133	110x100	20	Црна	6x6	630
1515DX30	204x204	170x170	20	Црна	4x7	270
1919DX30	226x226	190x190	20	Црна	4x7	300
2222DX30	274x274	230x230	20	Црна	4x6	200
2626DX30	311x311	275x275	20	Црна	6x5	100

Квадратни основи со вдлабнатини Square bases with cavities

Шифра Reference				Боја color		
1919DX30AL	226x226	4x(Ø85)	20	црна	4x7	300

Rectangular bases and domes altogether

Шифра Reference				Боја color		
4030DX10C	458x358	410x310	50	Кристална	3x4	50
4030DX12C	458x358	410x310	80	Кристална	3x4	40
4030DX13C	458x358	410x310	100	Кристална	3x4	40
4030DX30C	458x358	410x310	50	Црна	3x4	50
4030DX32C	458x358	410x310	80	Црна	3x4	40
4030DX33C	458x358	410x310	100	Црна	3x4	40

Clear rectangular domes

Шифра Reference						
1608DX01	200x122	160x85	40		2x8	480
1608DX02	200x122	160x85	60		2x8	480
1608DX03	200x122	160x85	80		2x8	480
2010DX00	245x149	205x110	30		2x6	450
2010DX01	245x149	205x110	40		2x6	450
2010DX02	245x149	205x110	60		2x6	450
2010DX03	245x149	205x110	80		2x6	450
2714DX01	310x180	270x135	40		2x6	240
2714DX02	310x180	270x135	60		2x6	240

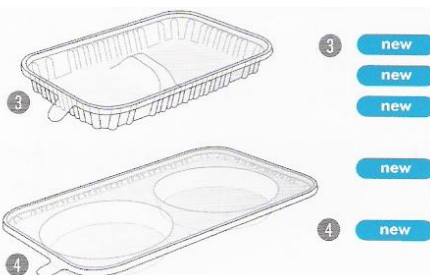
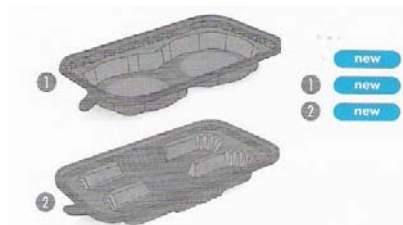
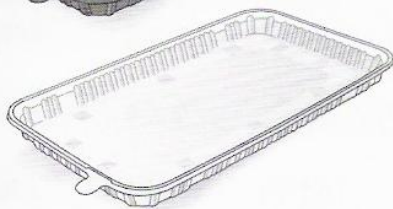
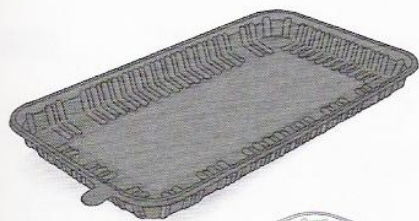

3210DX00	384x168	340x125	35		3x4	240
3210DX02	384x168	340x125	65		3x4	240
3210DX03	384x168	340x125	85		3x4	240

Правоаголни основи
Rectangular bases

Шифра Reference				Боја color		
1608DX30	190x115	160x85	20	Црна	4x7	480
2010DX10	236x143	205x110	20	Кристална	4x7	450
2010DX30	236x143	205x110	20	Црна	4x7	450
3210DX10	373x159	340x125	15	Кристална	6x5	240
3210DX30	373x159	340x125	15	Црна	6x5	240

Правоаголни основи со вдлабнатини
Rectangular bases with cavities

Шифра Reference				Боја color		
1608DX30AL	190x115	2x(Ø70)	20	Црна	4x7	480
1608DX30ALT	190x115	X2	20	Црна	4x7	480
2010DX30C	236x143	190x90	20	Црна	4x7	450
2010DX30AL	236x143	2x(Ø85)	20	Црна	4x7	450
2714DX30	303x172	270x135	20	Црна	6x5	240
2714DX30AL	303x172	1/2Ø24	20	Црна	6x5	240

Правоаголни црни основи
Rectangular black bases

Шифра Reference						
1608DX30G	190x115	X2	20		4x7	480
1608DX30R	190x115	2xØ75	20		4x7	480
1608DX30E	190x115	2x(130x30)	20		4x7	480

Правоаголни кристални основи
Rectangular cristal bases





Шифра Reference						
1608DX10G	190x115	X2	20		4x7	480
1608DX10R	190x115	2xØ75	20		4x7	480
1608DX10E	190x115	2x(130x30)	20		4x7	480
1909DX10T	226x122	2xØ90	20		4x7	450
2010DX10T	236x143	2xØ90	20		4x7	450





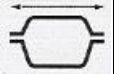

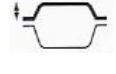

Clear rectangular domes

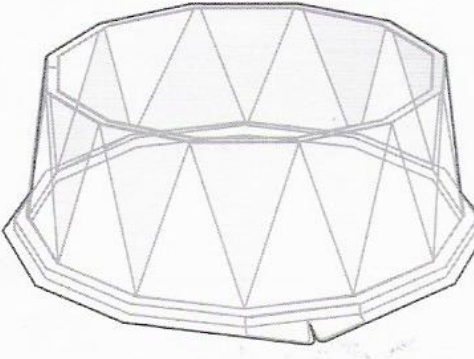

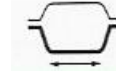
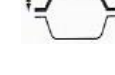



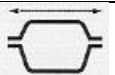
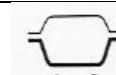
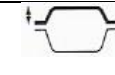

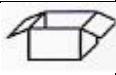

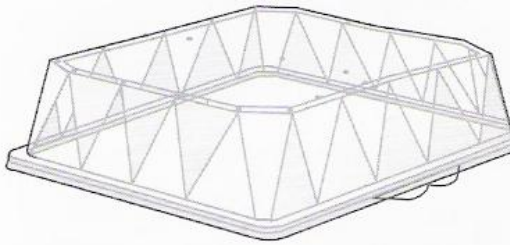
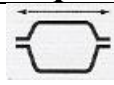
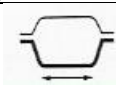
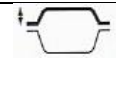
EL

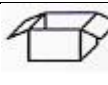
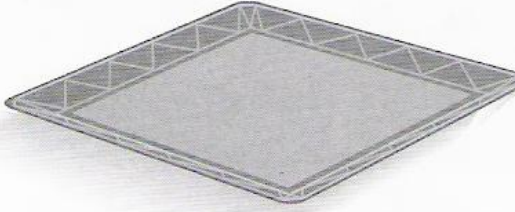
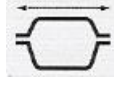
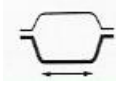
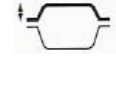
News

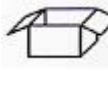
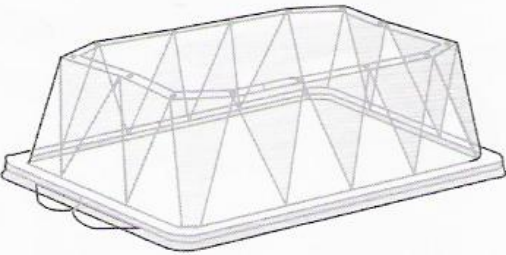
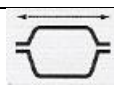
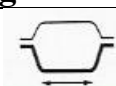
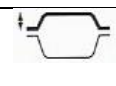

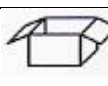

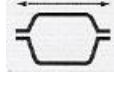
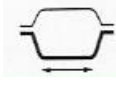
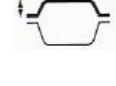
Електролюкс
Electrolux
Macedonia
Palenzo





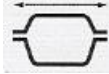

	Шифра Reference						
	1608DX00G	200x122	160x85	30		2x8	480
	1608DX03R	200x122	160x85	80		2x8	480
	1608DX00E	200x122	160x85	30		2x8	480
	1909DX00T	237x132	195x90	25		2x8	450
	2010DX00T	245x149	205x110	30		2x8	450

TRADIPACK 	Round gateaux domes					
	Шифра Reference					
D16TR02	227	160	65	3x4	240	
D16TR03	227	160	85	3x4	240	
D18TR01	248	180	50	3x4	240	
D18TR02	248	180	65	3x4	240	
D18TR03	248	180	85	3x4	240	
D20TR01	268	200	50	2x7	200	
D20TR02	268	200	65	2x7	200	
D20TR03	268	200	85	2x7	200	
D22TR01	290	220	50	2x6	200	
D22TR02	290	220	65	2x6	200	
D22TR03	290	220	85	2x6	200	
D24TR02	310	240	65	3x3	150	
D24TR03	310	240	85	3x3	150	
D26TR02	333	260	65	3x3	150	
D26TR03	333	260	85	3x3	150	
D28TR01	354	280	50	3x5	100	
D28TR02	354	280	65	3x5	100	
D28TR03	354	280	85	3x5	100	
	Црни кружни основи Black round bases					
	Шифра Reference					
	D16TR30	216	160	15	12x4	240
	D18TR30	236	180	15	12x4	240
	D20TR30	258	200	15	8x5	200
	D22TR30	278	220	15	8x3	200
	D24TR30	298	240	15	6x4	150
	D26TR30	319	260	15	6x4	150



	D28TR30	339	280	15	6x5	100
	Square gateaux domes					
	Шифра Reference					
	C13TR01	210x197	130x130	50	4x4	300
	C13TR02	210x197	130x130	65	4x4	300
	C17TRX01	235x235	170x170	50	3x4	240
	C17TRX02	235x235	170x170	65	3x4	240
	C19TR01	265x255	190x190	50	2x7	200
	C19TR02	265x255	190x190	65	2x7	200
	C19TR03	265x255	190x190	85	2x7	200
	C21TR01	285x275	210x210	50	2x7	200
	C21TR02	285x275	210x210	65	2x7	200
C21TR03	285x275	210x210	85	2x7	200	
	Црни квадратни основи Black square bases					
	Шифра Reference					
	C13TR30	185x185	130x130	15	16x3	300
	C17TRX30	223x223	170x170	15	6x7	240
	C19TR30	244x244	190x190	15	12x3	200
	C21TR30	264x264	210x210	15	8x3	200
	Правоаголни куполи Rectangular domes					
	Шифра Reference					
	R1310TR01	182x145	130x105	50	3x6	300
	R2016TR01	277x225	200x160	50	2x7	180
	R2210TR03	285x172	220x105	85	4x5	160
	R3210TR03	397x170	320x105	85	3x6	160
	Црни правоаголни основи Black rectangular bases					
	Шифра Reference					
	R1310TR30	160x136	130x105	15	16x3	300
	R2016TR30	254x215	200x160	15	15x2	180
	R2210TR30	274x162	220x105	15	16x3	160
	R3210TR30	373x161	320x105	15	14x2	160
	Црни основи со вдабнатини Black bases with cavities					

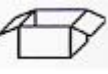
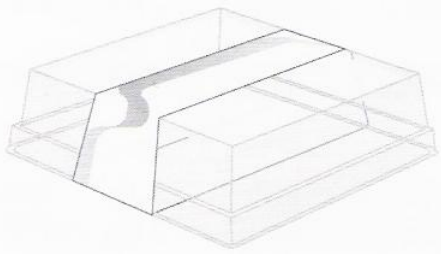

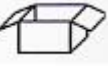
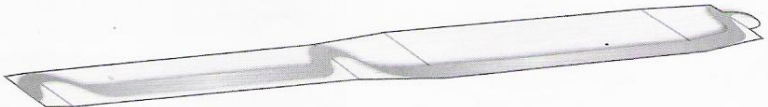

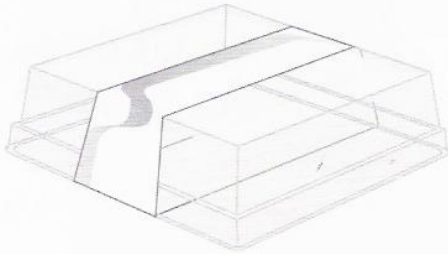

	Шифра Reference					
	R1310TR30AL	160x136	2x(60x105)	15	16x3	300
	R1310TR30AL2T	160x136	X2	15	6x12	300
	C21TR30AL	264x264	X15	15	8x4	200

DESIPACK	Square gateaux domes					
	Шифра Reference					
	DS19H65	220x220	190x190	65	3x4	210
	DS19H85 (1)	220x220	190x190	85	3x4	210
	DS19F10 (2)	210x210	190x190	20	4x8	210
	DS21H65	240x240	210x210	65	3x4	210
	DS21H85 (3)	240x240	210x210	85	3x4	210
	DS21F10 (4)	230x230	210x210	20	4x8	210
	DS2116H60	245x195	210x160	60	2x8	240
	DS2116H80 (5)	245x195	210x160	80	2x8	240
	DS2116F10 (6)	235x185	210x160	20	6x5	240
	DS23H85	265x265	230x230	85	2x7	150
	DS23H100 (7)	265x265	230x230	100	2x7	150
	DS23F10 (8)	255x255	230x230	20	6x6	150
	DS25H65	280x280	245x245	65	2x7	150
	DS25H85	280x280	245x245	85	2x7	150
DS25F10	270x270	250x250	20	4x6	150	
Card surround for fruit dessert						
	Шифра Reference	Компатибилна Compatible				
	DN1919H65F	DS19H65/DS19F10			7x4	210
	DN1919H85F	DS19H85/DS19F10			7x4	210
	DN2121H65F	DS21H65/DS21F10			7x4	210
	DN2121H85F	DS21H85/DS21F10			7x4	210
	DN2116H60F	DS2116H60/DS2116F10				240
	DN2116H80F	DS2116H80/DS2116F10				240
	DN2323H85F	DS2323H85/DS2323F10				150
	DN2323H100F	DS2323H100/DS2323F10				150
	DN2525H65F	DS2525H65/DS2525F10				100
	DN2525H85F	DS2525H85/DS2525F10				100
						

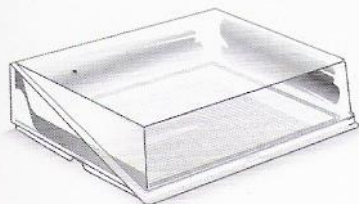
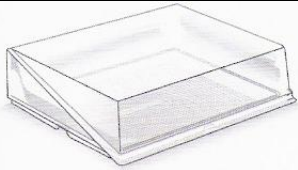

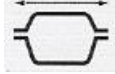

Card surround for chocolate dessert

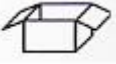
Шифра Reference	Компатибилна Compatible		
DN1919H65C	DS19H65/DS19F10	7x4	210
DN1919H85C	DS19H85/DS19F10	7x4	210
DN2121H65C	DS21H65/DS21F10	7x4	210
DN2121H85C	DS21H85/DS21F10	7x4	210
DN2116H60C	DS2116H60/DS2116F10		240
DN2116H80C	DS2116H80/DS2116F10		240
DN2323H85C	DS2323H85/DS2323F10		150
DN2323H100C	DS2323H100/DS2323F10		150
DN2525H65C	DS2525H65/DS2525F10		100
DN2525H85C	DS2525H85/DS2525F10		100



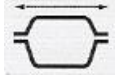



Self assembly gateau box with card insert (fruit dessert)

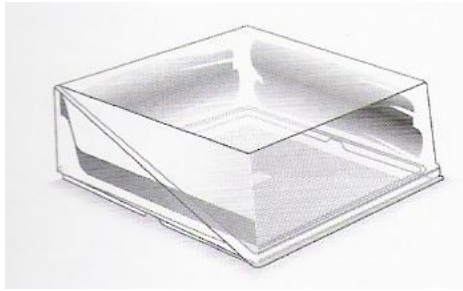

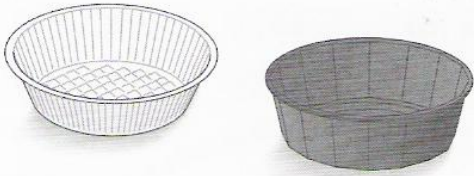
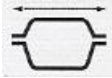



Шифра Reference					
CSN1616H60F	190x190	160x160	65	4x8	100
CSN1616H80F	190x190	160x160	85	4x8	100
CSN1919H65F	225x225	190x190	65	3x8	100
CSN1919H85F	225x225	190x190	85	3x8	100
CSN2116H60F	245x195	215x165	60	3x8	100
CSN2116H80F	245x195	215x165	80	3x8	100
CSN2121H65F	245x245	210x210	65	3x8	100
CSN2121H85F	245x245	210x210	85	3x8	100
CSN2323H85F	265x265	235x235	85	3x7	60
CSN2323H100F	265x265	235x235	100	3x7	60
CSN2525H65F		250x250	65		
CSN2525H85F		250x250	85		
CSN2727H85F		275x275	85		
CSN2727H100F		275x275	100		
CSN1611H70F		165x115	70	4x8	120

Self assembly gateau box with card insert (chocolate dessert)

Шифра Reference					
CSN1616H60C	190x190	160x160	65	4x8	100
CSN1616H80C	190x190	160x160	85	4x8	100

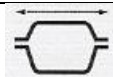

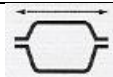
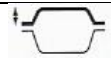
	CSN1919H65C	225x225	190x190	65	3x8	100
	CSN1919H85C	225x225	190x190	85	3x8	100
	CSN2116H60C	245x195	215x165	60	3x8	100
	CSN2116H80C	245x195	215x165	80	3x8	100
	CSN2121H65C	245x245	210x210	65	3x8	100
	CSN2121H85C	245x245	210x210	85	3x8	100
	CSN2323H85C	265x265	235x235	85	3x7	60
	CSN2323H100C	265x265	235x235	100	3x7	60
	CSN2525H65C		250x250	65		
	CSN2525H85C		250x250	85		
	CSN2727H85C		275x275	85		
	CSN2727H100C		275x275	100		
	CSN1611H70C		165x115	70	4x8	120







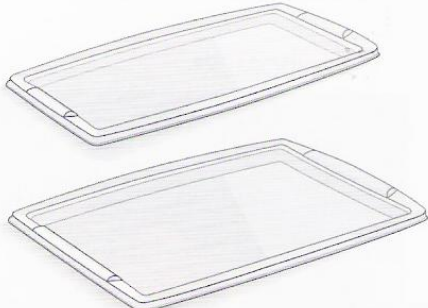
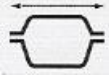
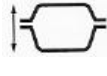

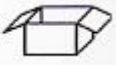

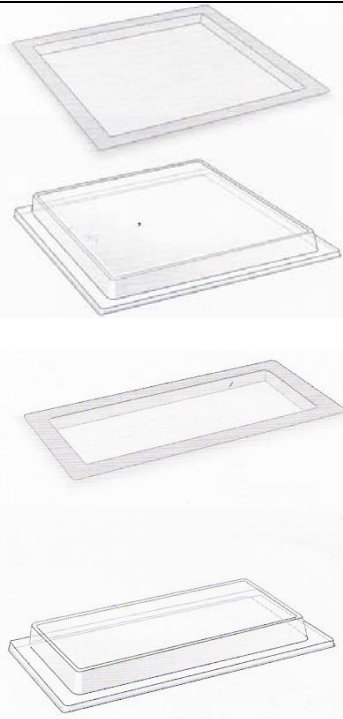
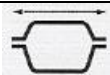
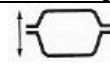



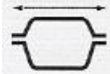
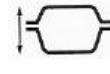

MOULIPACK		Mousse, rum baba, round moulds					
	Шифра Reference				Боја Color		
	BPR1T	85	29	100		24x7	1000
	BPR2T	93	27	120		24x7	1000
	CPRN1	85	29	100	Црна	6x7	800
	CPRN2GD	93	29	125	Црна	6x7	800

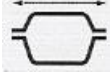
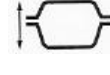
RAVIPACK		Clear trays				
	Шифра Reference					
	BFLH035H	245x155	35	2x8	600	
	BFLH060H	245x155	60	2x8	600	
	BFLH080H	245x155	80	2x8	600	
	Clear lid					
Шифра Reference						
CVBFL00ESTH	248x160	12	2x8	600		

ЧИНИИ И САДОВИ PLATES AND DISHES

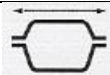
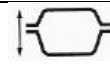

FESTIPACK	Чинии за презентација Presentation platters						
	Шифра Reference			Боја Color			
	PLC3616AR	360x163	18	Сребрена	5	14x6	50
	PLC3616OR	360x163	18	Златна	5	14x6	50
	PLC3616N	360x163	18	Црна	5	14x6	50
	PLC3625AR	360x253	18	Сребрена	5	8x8	50
	PLC3625OR	360x253	18	Златна	5	8x8	50
	PLC3625N	360x253	18	Црна	5	8x8	50

SELFIPACK	Presentation platters							
	Шифра Reference			Боја Color				
	PLACARRE380N	377x377	16	Црна	4	6x12	12	
	PLACARRE380C	377x377	16	Кристална	4	6x12	12	
	PLACARRE380B	377x377	16	Бела	4	6x12	12	
	Platter lid							
	Шифра Reference			Боја Color				
	CVPLA380H25	377x377	25	Кристална	12	6x6	48	
	CVPLA380H50	377x377	50	Кристална	12	6x6	36	
	Platter base							
	Шифра Reference			Боја Color				
PLA3813N	368x126	16	Црна	6	6x12	36		
PLA3813C	368x126	16	Кристална	6	6x12	36		
PLA3813B	368x126	16	Бела	6	6x12	36		
Platter lid								
Шифра Reference			Боја Color					
CVPLA3813H25	377x135	25	кристална	12	8x8	72		

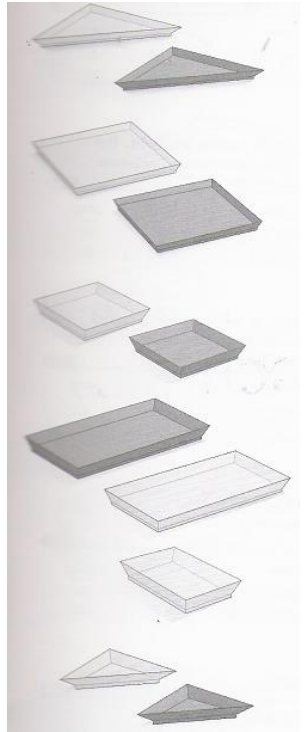
Components for platters

Шифра Reference			Боја Color			
TRIANG220N	158+158x220	20	Црна	50	17x10	400
TRIANG220B	158+158x220	20	Бела	50	17x10	400
TRIANG220C	158+158x220	20	Кристална	50	17x10	400
CARRE160N	161x161	10	Црна	50	8x8	200
CARRE160B	161x161	10	Бела	50	8x8	200
CARRE160C	161x161	10	Кристална	50	8x8	200
CARRE80N	80x80	10	Црна	25	6x6	800
CARRE80B	80x80	10	Бела	25	6x6	800
CARRE80C	80x80	10	Кристална	25	6x6	800
PLA1680N	161x80	10	Црна	50	8x8	400
PLA1680B	161x80	10	Бела	50	8x8	400
PLA1680C	161x80	10	Кристална	50	8x8	400
PLA0805N	80x53	10	Црна	50	6x6	1200
PLA0805B	80x53	10	Бела	50	6x6	1200
PLA0805C	80x53	10	Кристална	50	6x6	1200
TRIANGN	77+77x110	10	Црна	50	8x8	600
TRIANGB	77+77x110	10	Бела	50	8x8	600
TRIANGC	77+77x110	10	Кристална	50	8x8	600

Meal tray, claret coloured base, 2 white inserts, lid

Шифра Reference			Base	Insert		
PRP4KRB	326x256	75	●	○	4x8	30
PRP4KNB	326x256	75	●	○	4x8	30

Meal tray, claret coloured base, 4 white inserts, lid

Шифра Reference			Base	Insert		
PRP5KRB	420x264	65	●	○	4x5	60
PRP5KNB	420x264	65	●	○	4x5	60

Meal tray, claret coloured base, 6 white inserts, lid

Шифра Reference			Base	Insert		
PRP7KRB	420x326	60	●	○	4x4	30
PRP7KNB	420x326	60	●	○	4x4	30

White base and transparent lid



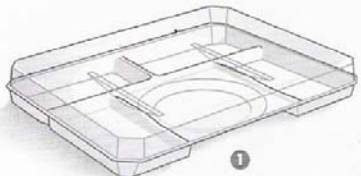
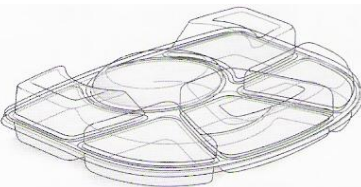
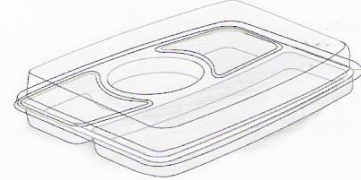







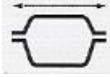
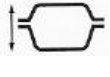

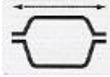
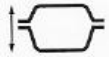

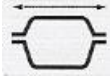
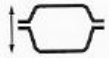

Шифра Reference			Боја Color		
PR1 1	395x295	70	Бела	4x4	50

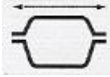
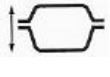

EL

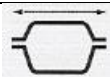
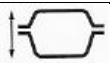

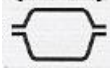
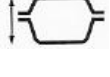







News











Електролюкс
Electrolux
Macedonia
Palenzo



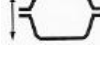

	PR2 2	418x300	44	Бела	20	4x5	100
Clear lid							
Шифра Reference			Боја Color				
COVPR	418x300	40,5	кристална	20	4x5	100	
CRC290	297x231	50			4x3	200	
White meal tray							
Шифра Reference			Боја Color				
PR290B	290x224	30	Бела		6x7	200	
PR290N/B	290x224	30	Црна/бела		6x7	200	
Small sealable compartmented food trays							
Шифра Reference			Боја Color				
PR2CPA	227x177	35	Бела	100	4x5	400	
PR2CPAH45	227x177	45	Бела	100	4x5	400	
Clear lid							
CVPR2CPA	239x181	27		50	3x4	400	
5 compartment white food tray							
Шифра Reference			Боја Color				
PR367B	381x231	42	Бела	60	4x5	240	
Clear lid							
CR367C	379x229	40		30	4x4	120	
Lunch box							
Шифра Reference			Боја Color				
X15H80	305x210	75	Кристална	125	3x4	125	
Meal tray/base and lid together							
Шифра Reference			Боја Color				
PRC5KN	230x257	50	Црна	25		100	
PRC5KVA	230x257	50	Зелена	25		100	
PRC5KMA	230x257	50	Портокалова	25		100	

Electrolux Macedonia
Bitola/Europe
+389(0)47 203 330

www.electrolux.mk www.elektroluks.mk www.elektroluks.eu
electrolux@t-home.mk elektroluks@t-home.mk

SERVIPACK	Translucent cup						
	Шифра Reference						
	CP200TP	95	57	200	25	4x4	600
	Lid						
Шифра Reference							
CVP95C	99	15		50	4x6	1000	

QUADRIPACK	Plates (PS) and lids (OPS)							
	Шифра Reference				Боја Color			
	RAV091N	105x105	47	90	Црна	50	4x8	400
RAV171N	135x135	47	170	Црна	25	4x8	200	
RAV171H56N	129x127	75	300	Црна	25	4x8	200	
RAV181N	170x105	47	180	Црна	25	6x7	200	
RAV301N	170x170	47	300	Црна	25	4x5	200	
RAV301C	170x170	47	300	Кристална	25	4x5	200	
RAV421N	215x170	47	420	Црна	25	4x4	200	
RAV421C	215x170	47	420	Кристална	25	4x4	200	
RAV601N	255x215	47	600	Црна	25	4x4	200	
RAV601C	255x215	47	600	Кристална	25	4x4	200	
Plates with cavities (PS) and lids (OPS)								
Шифра Reference				Боја Color				
RAV601N2C	255x215	47	x2	Црна	25	4x4	200	
RAV601N3C	255x215	25+20	x3	Црна	25	4x4	200	

SELFIPACK	Presentation platter						
	Шифра Reference			Боја Color			
PRP450N	449x289	20	Црна	25	5x8	50	







	Cardboard box for Quadripack						
	Шифра Reference			Боја Color			
	COFFRET450VA	449x289	60	Зелена	25	2x10	100



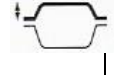

QUADRIPACK	Square plates							
	Шифра Reference			Боја Color				
		ACF240B	240	20	Бела	50	6x6	400
		ACF240N	240	20	Црна	50	6x6	400
		ACF240IV	240	20	Беж	50	6x6	400
		ACF240ROB	240	20	Бордо	50	6x6	400
		ACF240FUS	240	20	Розево	50	6x6	400
		ACF240VA	240	20	Зелена	50	6x6	400
		ACF240CH	240	20	Кафеава	50	6x6	400
		ACF240MA	240	20	Оранж	50	6x6	400
		ACF240TU	240	20	Тиркизна	50	6x6	400
		ACF240NA	240	20	Бисерна	50	6x6	400
		ACF240PRU	240	20	Лилјакова	50	6x6	400
		Шифра Reference			Боја Color			
	AC240OR	240	20	Златна	25	6x6	400	
	AC240AR	240	20	Сребрена	25	6x6	400	
	Square plates							
	Шифра Reference			Боја Color				
		AC185B	185	20	Бела	50	12x9	400
		AC185N	185	20	Црна	50	12x9	400
		AC185IV	185	20	Беж	50	12x9	400
		AC185ROB	185	20	Бордо	50	12x9	400
		AC185FUS	185	20	Розево	50	12x9	400
		AC185VA	185	20	Зелена	50	12x9	400
		AC185CH	185	20	Кафеава	50	12x9	400
		AC185MA	185	20	Оранж	50	12x9	400
		AC185TU	185	20	Тиркизна	50	12x9	400
		AC185NA	185	20	Бисерна	50	12x9	400
	AC185PRU	185	20	Лилјакова	50	12x9	400	
	Шифра Reference			Боја Color				
	AC185OR	185	20	Златна	25	12x9	400	



	○	AC185AR	185	20	Сребрена	25	12x9	400
	Lid							
		Шифра Reference			Боја Color			
		CVACF240	245	30	Кристална	25	4x4	200
	CVACF185	191	30	Кристална	25	6x7	100	

ОСТОПАК		Flat plates, bagged and in shelf-ready packaging						
		Шифра Reference			Боја Color			
	○	ASF240B	240	21	Бела	50	6x6	400
	●	ASF240N	240	21	Црна	50	6x6	400
	●	ASF240RO	240	21	Црвена	50	6x6	400
	●	ASF240BLE	240	21	Плава	50	6x6	400
	●	ASF240J	240	21	Жолта	50	6x6	400
	●	ASF240FUS	240	21	Розева	50	6x6	400
	●	ASF240VA	240	21	Зелена	50	6x6	400
	●	ASF240CH	240	21	Кафеава	50	6x6	400
	●	ASF240MA	240	21	оранж	50	6x6	400
	●	ASF240TU	240	21	Тиркизна	50	6x6	400
	○	ASF240IV	240	21	Беж	50	6x6	400
	●	ASF240PRU	240	21	лиљакова	50	6x6	400
	●	AS240OR	240	21	Златна	25	6x6	400
	●	AS240AR	240	21	Сребрена	25	6x6	400
	●	ASF240ROB	240	21	Бордо	50	6x6	400
	●	ASF240VS	240	21	Зелена	50	6x6	400
Flat plates with compartments								
		Шифра Reference			compartm ent			
		ASF240N2C	240	21	2	50	6x6	400
		ASF240N3C	240	21	3	50	6x8	400
Dessert plates, bagged and in shelf-ready packaging								
		Шифра Reference			Боја Color			
	○	ASF185B	185	20	Бела	50	12x9	400
	●	ASF185N	185	20	Црна	50	12x9	400
	●	ASF185BLE	185	20	Црвена	50	7x9	400
	●	ASF185J	185	20	Плава	50	7x9	400
	●	ASF185RO	185	20	Жолта	50	7x9	400
	●	ASF185FUS	185	20	Розева	50	7x9	400
●	ASF185VA	185	20	Зелена	50	7x9	400	

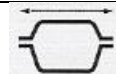
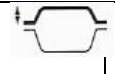
	●	ASF185CH	185	20	Кафеава	50	7x9	400
	●	ASF185MA	185	20	оранж	50	7x9	400
	●	ASF185TU	185	20	Тиркизна	50	7x9	400
	●	ASF185IV	185	20	Беж	50	7x9	400
	●	ASF185PRU	185	20	лиљакова	50	12x9	400
	●	AS185OR	185	20	Златна	25	12x9	400
	●	AS185AR	185	20	Сребрена	25	12x9	400
	●	ASF185ROB	185	20	Бордо	50	12x9	400
	●	ASF185VS	185	20	Зелена	50	12x9	400
	Lids							
	Шифра Reference			Боја Color				
	COV185C	189	30	Кристална	50	3x4	400	
	CV240C	249	31	кристална	50	4x4	200	

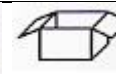









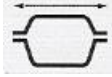



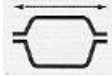

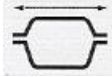

RONDOPACK		Flat plates, bagged and in shelf-ready packaging							
	○	AR240B	240	21	Бела	20	6x6	360	
	●	AR240N	240	21	Црна	20	6x6	360	
	●	AR240FUS	240	21	Розева	20	6x6	360	
	●	AR240MA	240	21	Оранж	20	6x6	360	
	●	AR240TU	240	21	Тиркизна	20	6x6	360	
	●	AR240CH	240	21	Кафеава	20	6x6	360	
	●	AR240VA	240	21	Зелена	20	6x6	360	
	●	ARF240OR	240	21	Златна	20	6x7	400	
	Dessert plates, bagged and in shelf-ready packaging								
		○	AR185B	185	13	Бела	20	12x9	360
●		AR185N	185	13	Црна	20	12x9	360	
●		AR185FUS	185	13	Розева	20	12x9	360	
●		AR185MA	185	13	Оранж	20	12x9	360	
●		AR185TU	185	13	Тиркизна	20	12x9	360	
●		AR185CH	185	13	Кафеава	20	12x9	360	
●		AR185VA	185	13	Зелена	20	12x9	360	
●		ARF185OR	185	13	Златна	20	12x9	360	
Lid									
	Шифра Reference			Боја Color					
	CVR185	218	30	Кристална	50	4x5	250		

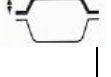

	CVR240	272	30	Кристална	50	4x4	200
--	--------	-----	----	-----------	----	-----	-----

FESTIPACK	Round plates with compartments						
	Шифра Reference			Боја Color			
	ARC300N	300	17		5	6x7	50
	Lid						
	CVR300	305	50		5	5x6	50
	Flat plates, bagged and in shelf-ready packaging						
	AR300N	303	20	Црна	5	8x7	50
	AR300OR	303	20	Златна	5	8x7	50
	AR300AR	303	20	Сребрена	5	8x7	50
	AR300J	303	20	Жолта	5	8x7	50
	AR300BLE	303	20	Плава	5	8x7	50
	Lid						
DOM05212	300	50			5x5	25	
Presentation platters							
PL280N	270x190	15	Црна	5	16x8	50	
PL280AR	270x190	15	Сребрена	5	14x8	50	
PL280OR	270x190	15	Златна	5	16x8	50	
PL280MARN	270x190	15	Црна мермерна	5	16x8	50	
PL350N	350x250	20	Црна	5	9x6	50	
PL350AR	350x250	20	Сребрена	5	9x6	50	
PL350OR	350x250	20	Златна	5	9x6	50	
PL350MARN	350x250	20	Црна мермерна	5	9x6	50	
PL450N	455x305	20	Црна	5	5x7	50	
PL450OR	455x305	20	Сребрена	5	5x7	50	
PL450AR	455x305	20	Златна	5	5x7	50	
PL450MARN	455x305	20	Црна мермерна	5	5x7	50	
Lid							
CVPL350	358x265	56	Кристална		9x6	50	



CVPL450	467x318	70	кристална		5x5	50
Presentation platters						
Шифра Reference			Боја Color			
PL295OVAR	300x195	18	Сребрена	5	16x10	50
PL295OVOR	300x195	18	Златна	5	16x10	50
PL400OVAR	395x250	23	Сребрена	5	5x7	50
PL400OVOR	395x250	23	Златна	5	6x6	50
PL460OVAR	450x295	28	Сребрена	5	6x5	50
PL460OVOR	450x295	28	Златна	5	7x5	50
Presentation platters						
Шифра Reference			Боја Color			
TR600OR	585x305	28	Златна	5	6x5	50
TR600AR	585x305	28	Сребрена	5	6x5	50
Presentation platters						
Шифра Reference			Боја Color			
PL360AR	348x245	15	Сребрена	5	18x3	50
PL360OR	348x245	15	Златна	5	18x3	50
PL360N	348x245	15	Црна	5	18x3	50
PLA3516AR	340x153	15	Сребрена	5	9x6	50
PLA3516OR	340x153	15	Златна	5	9x6	50
PLA3516N	340x153	15	Црна	5	9x6	50
Presentation platters						
Шифра Reference			Боја Color			
PLC280OR	275x190	8	Златна	5	16x10	50
PLC280AR	275x190	8	Сребрена	5	16x10	50
PLC280N	275x190	8	Црна	5	16x10	50
PLC350OR	360x253	10	Златна	5	8x8	50
PLC350AR	360x253	10	Сребрена	5	8x8	50
PLC350N	360x253	10	Црна	5	8x8	50
PLC450OR	460x305	18	Златна	5	8x8	50
PLC450AR	460x305	18	Сребрена	5	8x8	50
PLC450N	460x305	18	Црна	5	8x8	50



MOULIPACK

Шифра Reference				Боја Color				
1	OCTO65C	65	15		Кристална	100	12x8	1000
2	CSJ65C	70x65	15	30	Кристална	25	12x8	225
3	CANOT65C	65	20		Кристална	100	8x8	1000
4	GOUT65C	80	45		Кристална	100	12x8	1000
5	SWING	62	10		Кристална	100	8x8	2000
Шифра Reference				Боја Color				
6	KARE60C	60	14	30	Кристална	50	12x8	400
7	CAR61C	65	4		Кристална	50		200
8	CAR61AR	65	14		Сребрена	50		200
9	CSJCC	70x65	15	30	Кристална	25	12x8	225
10	STARC	80x89	18		Кристална	24	12x8	360
11	CHISTERAB	110			Кристална	50	12x8	900
12	CHISTERAC	110			Кристална	50	12x8	900
13	CUCHIC	120		20	Кристална	50	12x8	600
14	CUCHI120C	120	10	13	Кристална	100	12x8	900
15	CUZAK130AR	130	10	8	Сребрена	20		200
16	STELLY	105x41	5		Кристална	50	12x8	1200
	STELLYN	105x41	5		Црна	50	12x8	1200
17	CASTELLYN	365x260	28		Црна	40	8x8	80
18	BOL90CC	70	35	90	Кристална	24	12x8	192
19	CP12C	75	65	115	Кристална	50	9x5	250
Шифра Reference				Боја Color				
20	ТАЈТС	70	80	50	Теракота	50	12x8	100
	ТАЈТП	70	80	50	Кристална	50	12x8	100
21	CARO	64x64	10	30	Кристална	50	12x8	397
22	TRIANGN	80x80x110		10	Црна	50	17x10	400
	TRIANGC	80x80x110		10	Кристална	50	17x10	400
	TRIANGB	80x80x110		10	Бела	50	17x10	400
23	CARRE80N	80x80	10		Црна	25	6x6	800
	CARRE80C	80x80	10		Кристална	25	6x6	800
	CARRE80B	80x80	10		Бела	25	6x6	800
24	PLA0805N	80x53	10		Црна	50	6x6	1200
	PLA0805C	80x53	10		Кристална	50	6x6	1200
	PLA0805B	80x53	10		Бела	50	6x6	1200
25	PL1965AR	65x190	14	250	Сребрена	50		200
26	VED6C	40	52	50	Кристална	50	9x8	1000

EL

News

Електролюкс
Electrolux
Macedonia
Palenzo

	27	VED10C	45	85	90	Кристална	20	5x6	1000
	28	VERRE5C	40	52	50	Кристална	60	12x8	300
	29	COPAC	55	46	70	Кристална	24	12x8	240
	30	VEROC	52	45	60	Кристална	24	12x8	216
	31	VERUBANC	40	65		Кристална	50	12x8	200
	32	VERONDOC	55	85	65	Кристална	12	12x8	120
	33	COPA90C	62	47	77	Кристална	24	12x8	192
	34	VERINE6C	50x50	50		Кристална	50	8x8	1000
	35	VERINE12C	68x68	60		Кристална	50	9x5	1000
	36	VERINE20C	72x72	70		Кристална	50	6x5	1000
	37	CVERINE20	76x76	7		Кристална	50	4x4	1000
	38	Шифра Reference				Боја Color			
	39	BBODEGA180	76	56	180	Кристална	20		300
	40	CVBODEGA180	77			Кристална	50		300
	41	BODEGA250	82	60	250	Кристална	20		300
	42	VER24C	82	100	250	Кристална	10		300
	43	CVBODEGA250	82			Кристална	50		300
	44	VER15C	70	80	140	Кристална	10		300
	45	COVVER15C	70			Кристална	50		300
	46	TRIOBAMBOU	178x60			Бамбус	15	12x8	75
	47	PLANCHABAMBOU	100			Бамбус	30	12x8	360
	48	CAR60BAMBOU	60x60			Бамбус	30	12x8	360
	49	ROND60BAMBOU	60			Бамбус	30	12x8	360
	50	PICBAMBOU	100			Бамбус	20	12x8	120
	51	CU90BAMBOU	90			Бамбус	100		
	52	CU100C	100			Кристална	250		5000
	53	CU100AR	100			Сребрена	100	10x25	1000
	54	FO100C	100			Кристална	250		5000
	55	FO100AR	100			Сребрена	100	10x25	1000
	56	FO90BAMBOU	90			Бамбус	100		

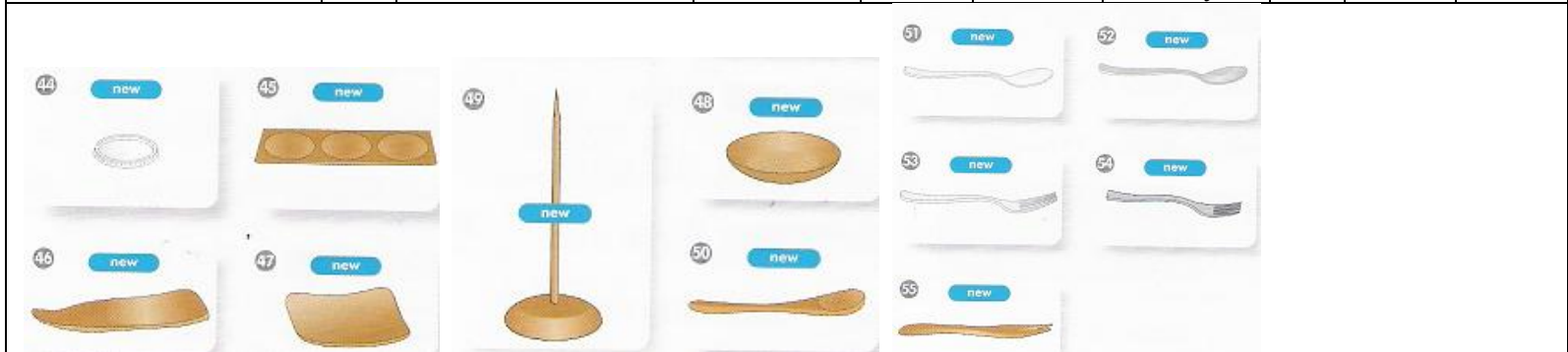

Electrolux Macedonia
Bitola/Europe
+389(0)47 203 330

www.electrolux.mk www.elektroluks.mk www.elektroluks.eu
electrolux@t-home.mk elektroluks@t-home.mk

SERVIPACK	Translucent cup							
	Шифра Reference				Боја Color			
	C195TP	95	40	100/160		50	6x4	800
	Lid							
	Шифра Reference				Боја Color			
	CVP95CH	99	29			50	4x6	100
	Cutlery pack in clear wrapper							
	Шифра Reference		Боја Color		Парчиња/ сет			
	KITB2	163	Бела		2	6x7	500	
	KITPDJSB	163/125	Бела		3	8x5	250	
	KITB3	163	Бела		3	6x7	250	
	KITB4	163/125	Бела		4	6x7	250	
	KITB5	163/125	Бела		5	6x11	250	
	KIT6C	163/125	Кристална		6	6x7	250	
	KIT6SB	163/125	Бела		6	8x5	250	
	Clear serving cutlery							
	Шифра Reference		Боја Color		Парчиња/ сет			
	CUFO220	260	Кристална		5	9x6	50	
	LOUCHEC	300	Кристална		5	9x6	50	
	PINCESL	270	Кристална		5	9x9	50	
	PELTARTE	250	Кристална		5	9x6	50	

FESTIPACK	Octogonal plate with compartments							
	Шифра Reference			Боја Color				
	ASC300N	300	24	црна	5	6x7	50	
	Lid							
	Шифра Reference			Боја Color				
	CV300	300	50		5	5x6	50	
	Salad bowl							
	Шифра Reference							
	SL2200C	260	90	2200	6	8x6	36	
	SL4500C	300	100	4500	6	6x4	36	
	Lid							
	Шифра Reference							
	COVSL2200	260	40		6	12x4	36	
	COVSL4500	300	40		6	6x5	36	
	2 pieces set							
	Шифра Reference			Боја Color				
	USTUCL	260		Кристална		9x6	50	
	Presentation platters							
	Шифра Reference			Боја Color				
	AS300OR	308	15	Златна	5	14x4	50	
	AS300AR	308	15	Сребрена	5	14x4	50	
AS300N	308	15	Црна	5	14x4	50		
AS300MARN	308	15	Црна мермерна	5	14x4	50		
Lid								
Шифра Reference			Боја Color					
CVAS300	305	50	Кристална		10x6	25		

EL

News

Електролюкс
Electrolux
 Macedonia
 Palenzo



Presentation platters

Шифра Reference			Боја Color			
C15OR	155x135	27	Златна	5	26x8	50
C15AR	155x135	27	Сребрена	5	26x8	50
C34OR	340x310	42	Златна	5	14x4	50
C34AR	340x310	42	Сребрена	5	14x4	50

Electrolux Macedonia
 Bitola/Europe
 +389(0)47 203 330

www.electrolux.mk www.elektroluks.mk www.elektroluks.eu
electrolux@t-home.mk elektroluks@t-home.mk