

Mini slides DGSL

FESTO



Precise, resilient
and compact

Info 160

DGSL – The superlative new slide range

Unique in its precision, resilience, compact design and easy installation.

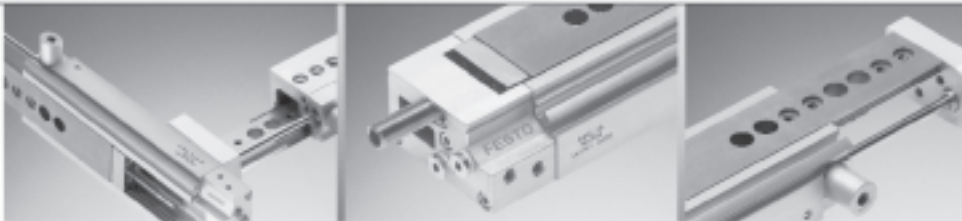

Simple and direct

Keeping everything in hand

More precise



reddot design award
winner 2007

Pure precision

Designed for high-precision sliding, picking and insertion, even under high mechanical loads. The key to unbelievable precision: An innovative guide unit with a repetition accuracy of 0.01 mm and linearity and parallelism within the 1/100 mm range – even at maximum stroke.

Pure functionality

The functionality comes in the form of the optional clamping unit and the end position locking. They prevent uncontrolled sinking of the load on the workpiece carrier in the event of a pressure drop and provide protection in emergency stop situations. DGSL/DGSL units can be combined

directly without adapter plates, either dynamically as a pick & place system or flexibly with intermediate position in a piggy-back installation. Precision interfaces with Festo's modular handling system are included.

Pure flexibility

From MINI to MAXI: A comprehensive range with 8 sizes ranging from 4 ... 25 and strokes of up to 200 mm meets all conceivable requirements. The alternative stop variants with polymer cushioning, cushioned metal stop or shock absorber provide the best technological and economical solution for every application. All stop elements can be adjusted using the function end cap on the rear face.

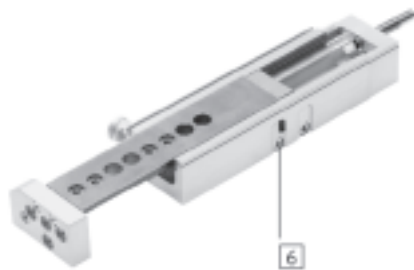
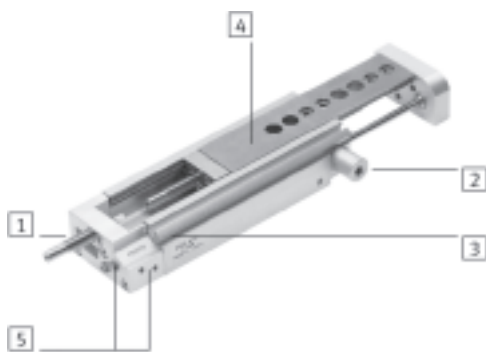

1 Cushioning

Choice of three types of cushioning with precision stroke adjustment:

- Flexible cushioning without metallic end position
- Adjustable, flexible cushioning with metallic end position
- Hydraulic shock absorbers

2 Clamping unit/end lock

- Mechanical clamping, for fixing the slide in any position, frictional locking
- Mechanical lock when the end position is reached, for fixing the slide in the unpressurised, retracted state, mechanical locking

3 Position sensing

- Proximity sensors can be integrated, therefore there are no projecting parts
- Two slots for mounting
 - Optimised visibility from the side and from above

4 Innovative guide unit

- Wide roller track, which provides extremely high rigidity
- High load capacity
- High precision
- Housing and steel slide form the guide; no accumulative tolerances

5 Compressed air connections

Options on two sides:

- On front face
- At the side

6 Coarse stroke adjustment

The end stop for the front end position can be shifted mechanically, e.g. to shorten the stroke

Mini slides DGSL

Key features

FESTO

General information

- Double-acting drives
- Wide range of options for mounting on:
 - drives, grippers
- System product for handling and assembly technology
- Highly flexible thanks to versatile assembly and connection options on:
 - drive body, slide, yoke plate

The technology in detail

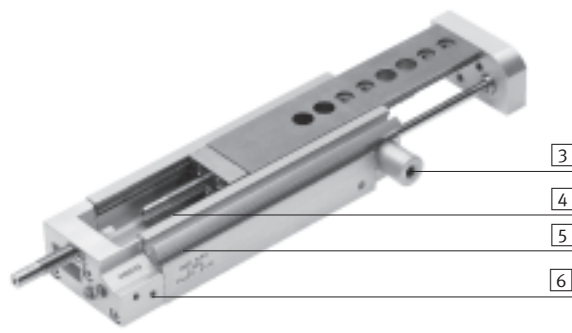

1 Cushioning



- Choice of three types of cushioning:
 - Flexible cushioning without metal end stop (P)
 - Flexible cushioning with metal end stop (P1)
 - Hydraulic shock absorbers (Y3)

2 Coarse stroke adjustment

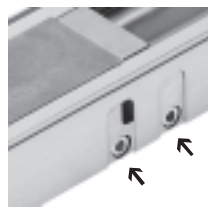

- The end stop for the front end position can be adjusted mechanically, e.g. to shorten the stroke

3 Clamping unit



- Mechanical clamping, for fixing the slide in any position; frictional locking (C)

3 End position locking



- Mechanical locking when the end position is reached, for fixing the slide in the unpressurised, retracted state; positive locking (E3)

4 Innovative guide unit

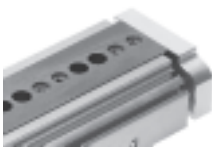

- Wide roller track, which provides extremely high rigidity
- High load capacity
- High precision
- Housing and steel slide form a guide: there are no accumulative tolerances

5 Position sensing

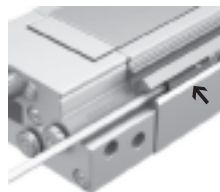

- Proximity sensors can be integrated, so there are no projecting parts
- Two slots for mounting
- Clearly visible from the side and from above

6 Compressed air connections

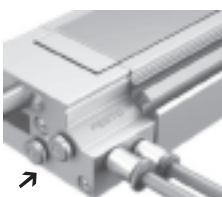

- Options on two sides:
 - On front face
 - At the side

Mini slides DGSL

System example

System product for handling and assembly technology

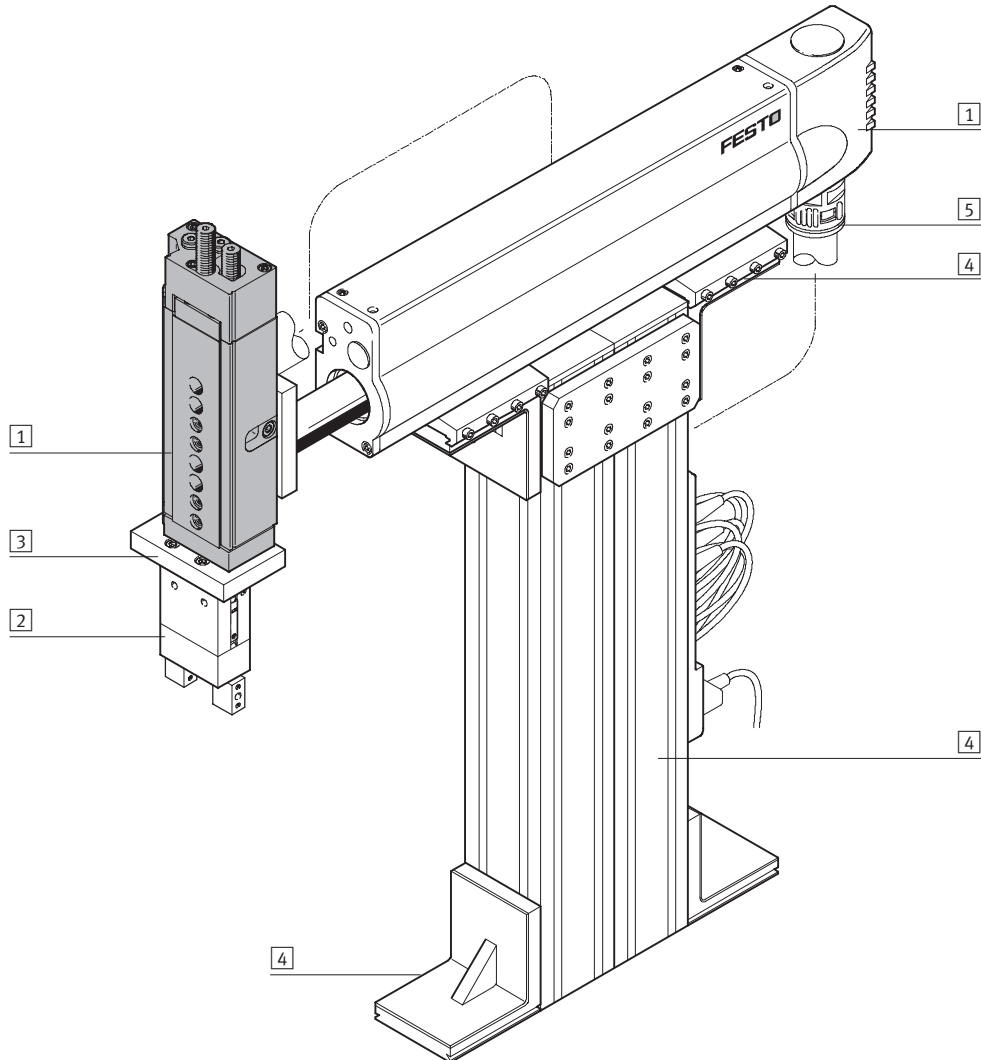

System elements and accessories		
	Brief description	→ Page/Internet
1	Drives	Wide range of combinations possible for handling and assembly technology drive
2	Gripper	Wide range of variations possible for handling and assembly technology gripper
3	Adapter plate	For drive/drive and drive/gripper connections adapter kit
4	Basic components	Profiles and profile connections as well as profile/drive connections basic component
5	Installation components	For achieving a clean, safe layout for electrical cables and tubing installation component
-	Axes	Wide range of combinations possible for handling and assembly technology axes
-	Motors	Servo and stepper motors, with or without gear unit motor

Mini slides DGSL

Peripherals overview

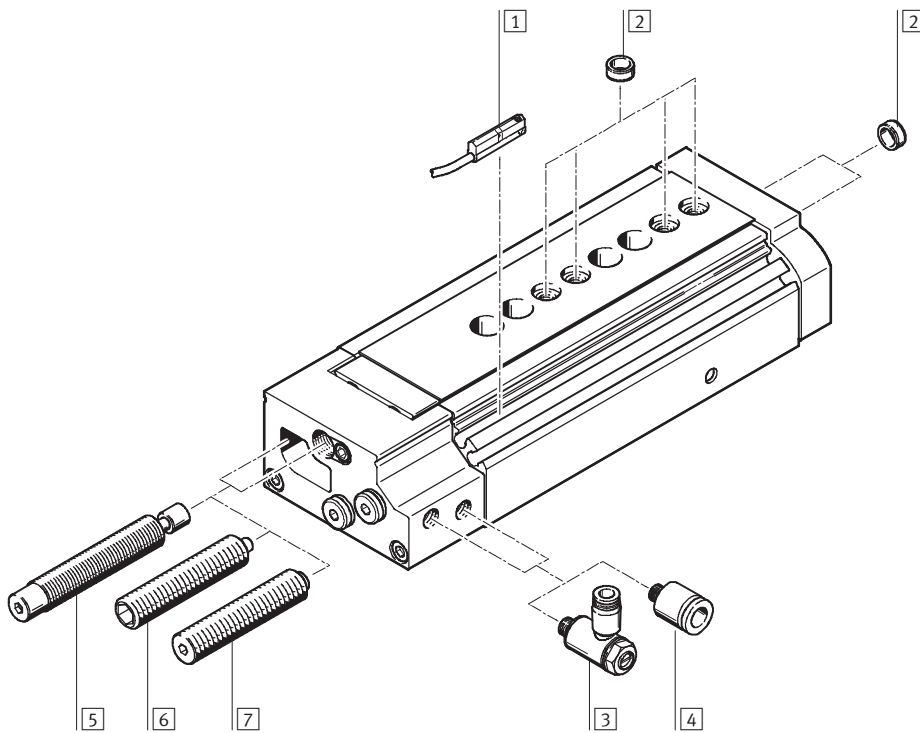

 Note
End stops must not be removed.

Accessories			
	Brief description	→ Page/Internet	
1	Proximity sensor SME/SMT-10	For position sensing. Can be integrated in sensor slot, thus no projecting parts	42
2	Centring sleeve ZBH	For centring loads and attachments (the scope of delivery of the mini slide includes the centring sleeves)	42
3	One-way flow control valve GRLA	For speed regulation	42
4	Push-in fitting QSM	For connecting compressed air tubing with standard external diameters	42
5	Cushioning with shock absorber Y3	For large loads and high speed. Ensures precise, metal-to-metal contact after the cushioning	42
6	Cushioning with stop P1	Precision metal stop for small loads at low speed	42
7	Cushioning P	Flexible stop for medium loads at medium speed (standard version)	-

Mini slides DGSL

Type codes

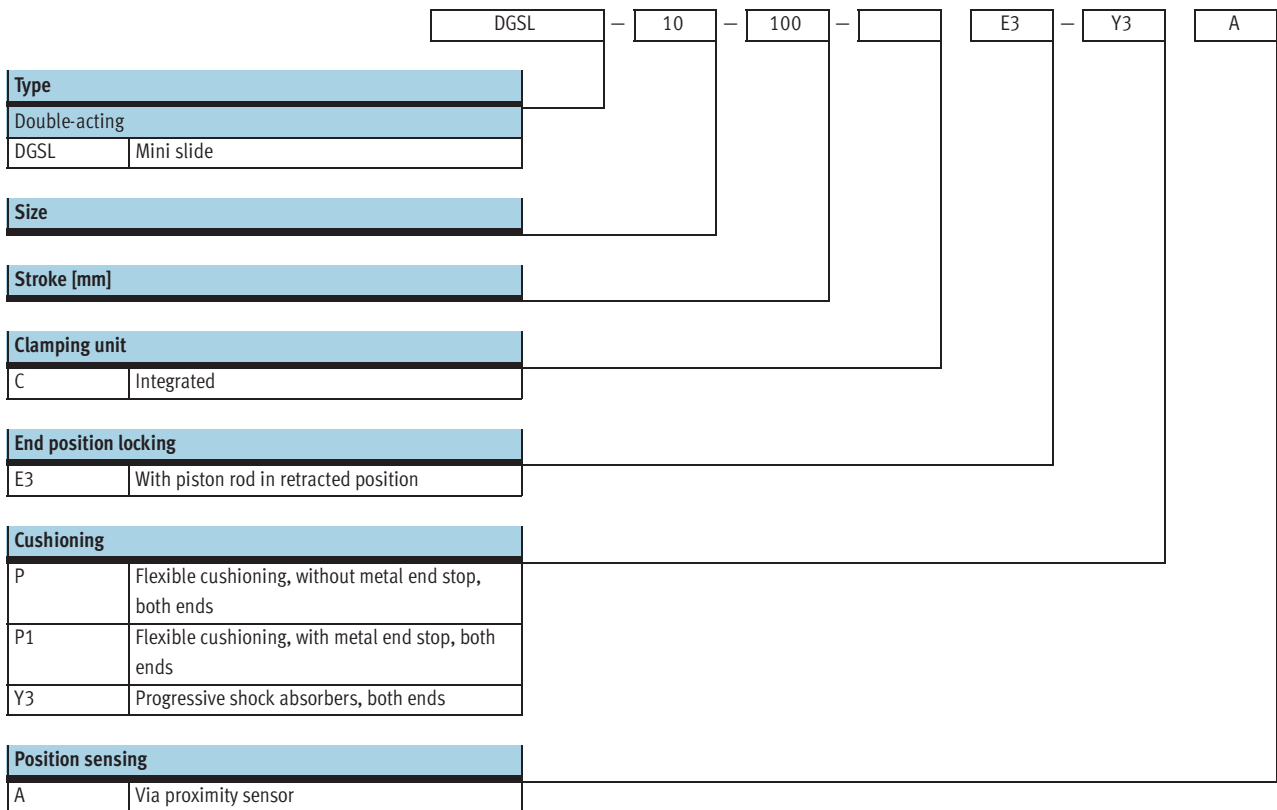

Mini slides DGSL

Technical data



Function

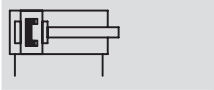

Wearing parts kits

→ 42

Technical data:

- DGSL-C (with clamping unit)
 - DGSL-E3 (with end position locking)
- 38



- - Size
4 ... 25
- - Stroke length
10 ... 200 mm

General technical data				4	6	8	10	12	16	20	25
Size											
Pneumatic connection				M3			M5		G1/8		
Constructional design				Scotch yoke system							
Guide				Ball bearing cage guide							
Type of mounting				Via through-holes Via female threads							
Cushioning	P			Flexible cushioning, without metal end stop, both ends							
	P1			Flexible cushioning, with metal end stop, both ends, adjustable							
	Y3			-			With progressive shock absorber, both ends				
Position sensing				Via proximity sensor							
Mounting position				Any							
Max. advancing speed		[m/s]		0.5			0.8				
Max. retracting speed		[m/s]		0.5			0.8				
Repetition accuracy	P1/Y3	[mm]		±0.01							
	P	[mm]		0.3							

Operating and environmental conditions				4	6	8	10	12	16	20	25
Size											
Operating medium				Dried compressed air, lubricated or unlubricated							
Min. operating pressure		[bar]		2.5	1.5			1			
Max. operating pressure		[bar]		8							
Ambient temperature ¹⁾		[°C]		0 ... +60							

1) Note operating range of proximity sensors

Piston-Ø, Forces and impact energy				4	6	8	10	12	16	20	25
Size											
Piston-Ø		[mm]		6	8	10	12	16	20	25	32
Theoretical force at 6 bar, advancing		[N]		17	30	47	68	121	188	295	483
Theoretical force at 6 bar, retracting		[N]		13	23	40	51	104	158	247	415
Impact energy at end positions	P	[Nm]		0.015	0.05	0.08	0.12	0.25	0.35	0.45	0.55
	P1	[Nm]		0.005	0.02	0.03	0.04	0.06	0.12	0.2	0.25
	Y3	[Nm]		-	-	0.8	1.3	2.5	4	8	12

Mini slides DGSL

Technical data

FESTO

Weight [g]									
Size	Stroke	4	6	8	10	12	16	20	25
Product weight without cushioning component									
	10	82	158	235	396	604	896	1535	2520
	20	93	179	263	434	660	954	1649	2670
	30	104	197	289	470	711	1008	1746	2824
	40	–	215	313	507	762	1072	1857	2983
	50	–	232	370	548	813	1143	1991	3137
	80	–	–	454	727	1112	1365	2295	4019
	100	–	–	–	813	1229	1712	2921	4519
	150	–	–	–	–	1499	2034	3620	5344
	200	–	–	–	–	–	–	4248	6139
Moving load without cushioning component									
	10	31	68	101	163	256	403	660	998
	20	34	76	111	180	279	432	710	1052
	30	38	83	121	194	299	459	750	1115
	40	–	90	130	208	320	486	801	1181
	50	–	99	152	226	340	519	858	1244
	80	–	–	185	299	456	618	998	1567
	100	–	–	–	334	507	776	1254	1761
	150	–	–	–	–	614	910	1566	2102
	200	–	–	–	–	–	–	1807	2432
Cushioning component									
	P	2	3.6	6	14	23	45.6	82.4	106
	P1	1.6	3	5	12	19.7	39.6	77.3	104
	Y3	–	–	6	11	21	42	67	91

Materials

Sectional view

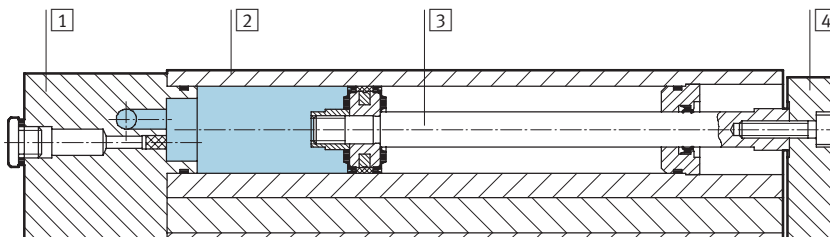

Mini slide		
1	Cover	Anodised aluminium
2	Housing	Anodised aluminium
3	Piston rod	High-alloy steel
4	Yoke plate	Anodised aluminium
–	Guide	Tempered steel
–	Seals	Thermoplastic rubber, hydrogenated nitrile rubber, nitrile rubber
	Note on materials	Free of copper and PTFE

Mini slides DGSL

Technical data



Travel time t as a function of the effective load m and the cushioning P – horizontal mounting position



The values in the graphs are determined by calculation. The travel time as a function of effective load must not be reduced below

the values shown, because the kinetic impact or residual energy at the end positions can result in damage to the drive.

Vertical mounting position → 13

Advancing Stroke 10 mm, size 4 ... 10

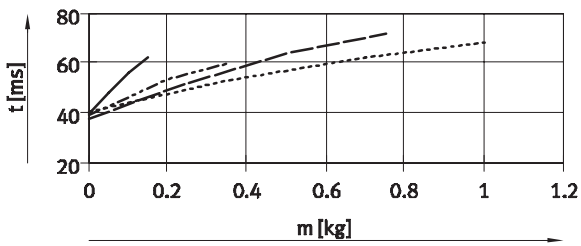

Retracting Stroke 10 mm, size 4 ... 10

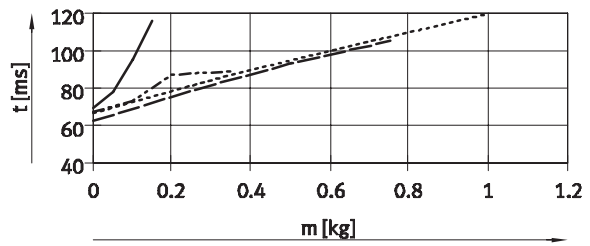

Stroke 10 mm, size 12 ... 16

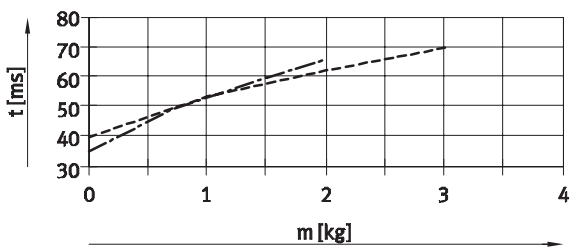

Stroke 10 mm, size 12 ... 16

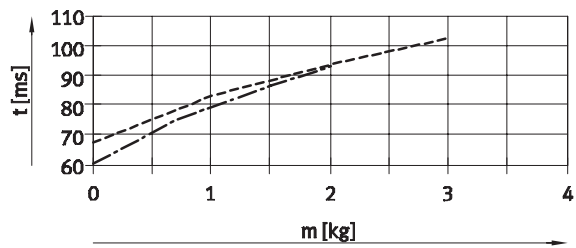

Stroke 10 mm, size 20 ... 25

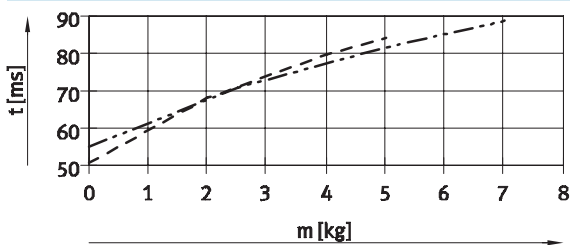

Stroke 10 mm, size 20 ... 25

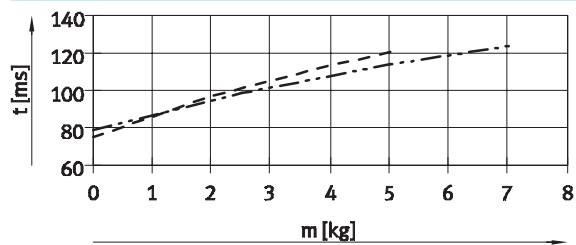

Stroke 30 mm, size 4 ... 10

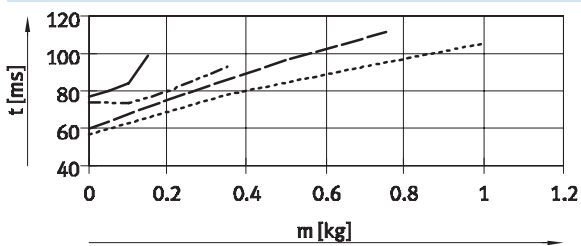

Stroke 30 mm, size 4 ... 10

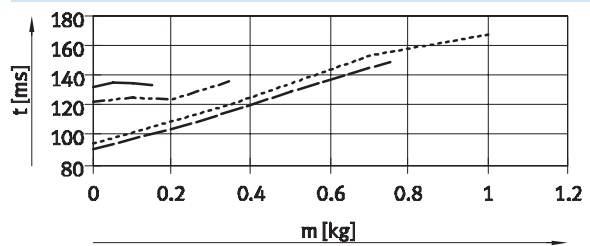

- DGSL-4
- - - DGSL-6
- · - DGSL-8
- · · DGSL-10
- · - DGSL-12
- - - DGSL-16
- · - DGSL-20
- · - DGSL-25

Mini slides DGSL

Technical data

Travel time t as a function of the effective load m and the cushioning P – horizontal mounting position

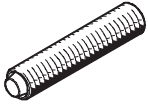

The values in the graphs are determined by calculation. The travel time as a function of effective load must not be reduced below

the values shown, because the kinetic impact or residual energy at the end positions can result in damage to the drive.

Vertical mounting position → 13

Advancing

Stroke 30 mm, size 12 ... 25

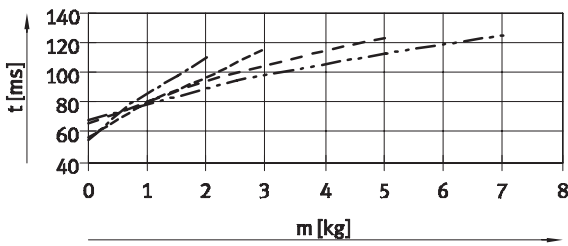

Retracting

Stroke 30 mm, size 12 ... 16

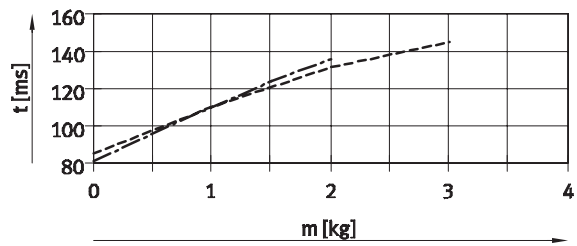

Stroke 30 mm, size 20 ... 25

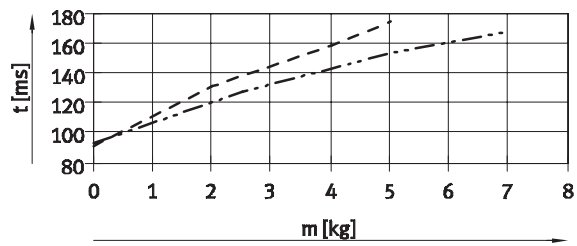

Stroke 50 mm, size 6 ... 12

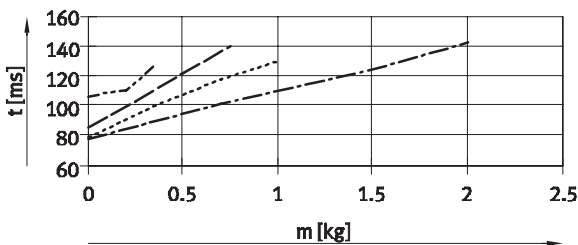

Stroke 50 mm, size 6 ... 12

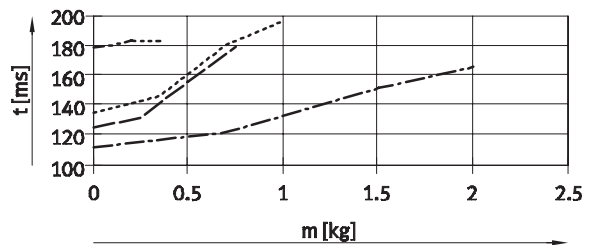

Stroke 50 mm, size 16 ... 25

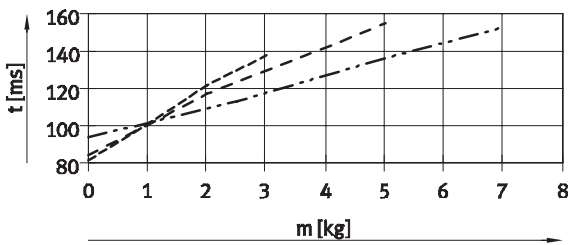

Stroke 50 mm, size 16

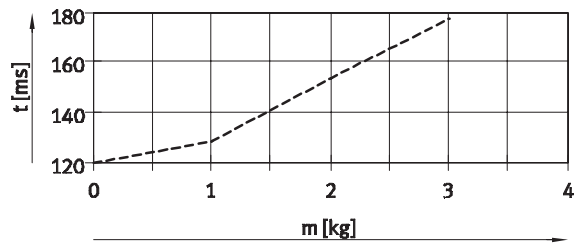

Stroke 50 mm, size 20 ... 25

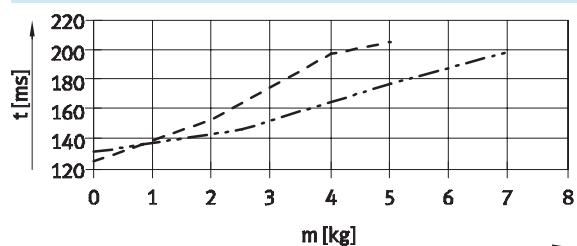

- DGSL-4
- - - DGSL-6
- · - DGSL-8
- · · DGSL-10
- · - DGSL-12
- - - DGSL-16
- - - DGSL-20
- · - DGSL-25

Mini slides DGSL

Technical data



Travel time t as a function of the effective load m and the cushioning P – horizontal mounting position

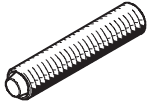

The values in the graphs are determined by calculation.
The travel time as a function of effective load must not be reduced below

the values shown, because the kinetic impact or residual energy at the end positions can result in damage to the drive.

Vertical mounting position
→ 13

Advancing Stroke 100 mm, size 10 ... 16

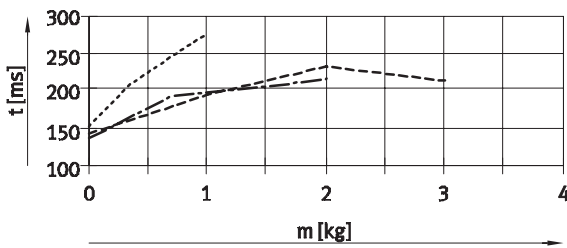

Retracting Stroke 100 mm, size 10 ... 16

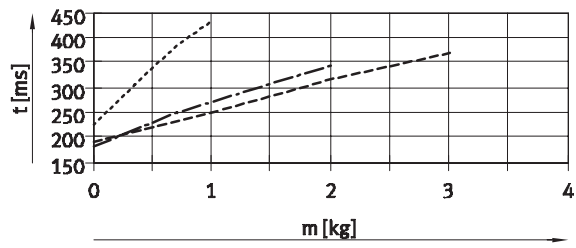

Stroke 100 mm, size 20 ... 25

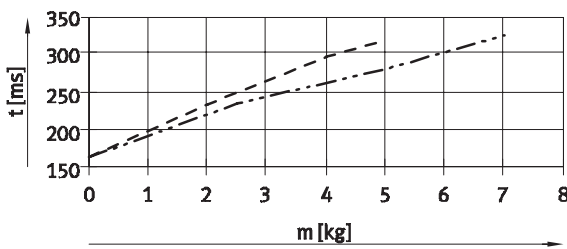

Stroke 100 mm, size 20 ... 25

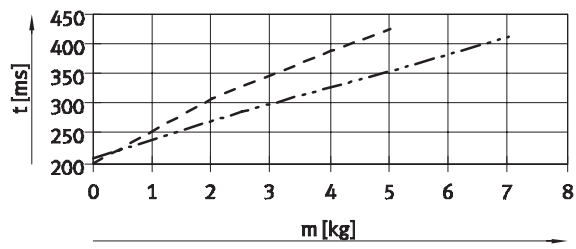

Stroke 150 mm, size 12 ... 16

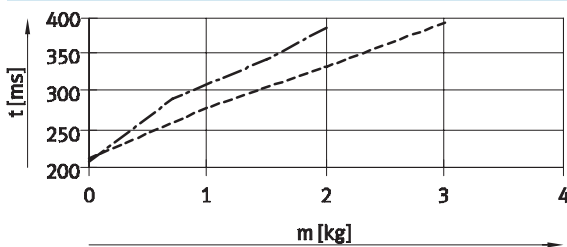

Stroke 150 mm, size 12 ... 16

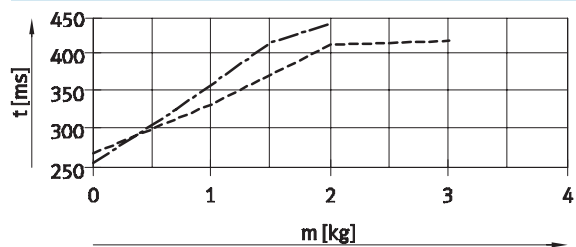

Stroke 150 mm, size 20 ... 25

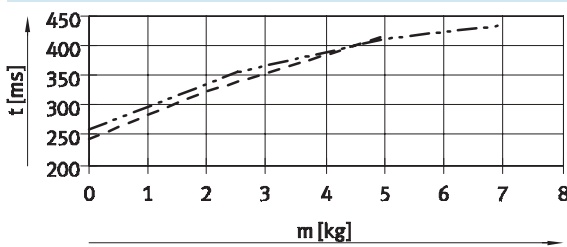

Stroke 150 mm, size 20 ... 25

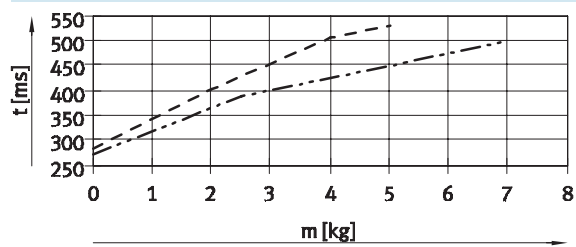

- | | | | |
|-----------|---------|-----------|---------|
| — | DGSL-4 | - - - - | DGSL-12 |
| - · - · - | DGSL-6 | - - - - - | DGSL-16 |
| - - - - | DGSL-8 | - - - - - | DGSL-20 |
| - · - · - | DGSL-10 | - - - - - | DGSL-25 |

Mini slides DGSL

Technical data

Travel time t as a function of the effective load m and the cushioning P – horizontal mounting position

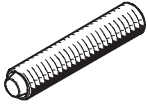

The values in the graphs are determined by calculation. The travel time as a function of effective load must not be reduced below

the values shown, because the kinetic impact or residual energy at the end positions can result in damage to the drive.

Vertical mounting position
→ 13

Advancing

Stroke 200 mm, size 20 ... 25

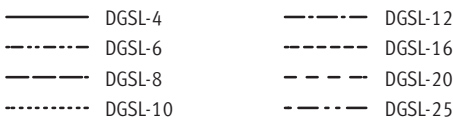
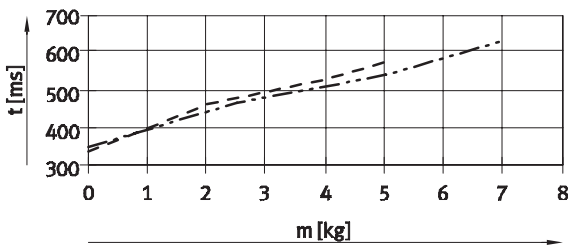

Retracting

Stroke 200 mm, size 20 ... 25

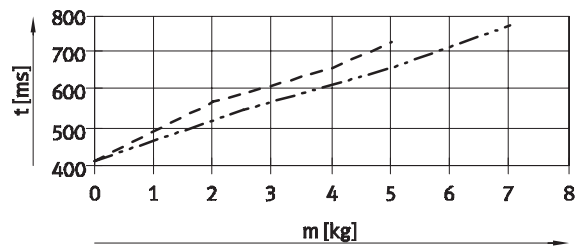

Vertical mounting position

The travel times for a vertical mounting position are calculated by multiplying the data ascertained for

horizontal mounting position by a correction factor k_a (advancing) and k_r (retracting), see adjacent table.

Given:

- Stroke = 200 mm
- Size = 20
- Effective load = 3 kg
- Ascertained travel time t_h (horizontal), see graph:
 - Advancing = 500 ms
 - Retracting = 600 ms

Calculated travel time t_v (vertical):

- Advancing: $t_v = t_h \times k_a$
 $t_v = 500 \text{ ms} \times 0.9 = 450 \text{ ms}$
- Retracting: $t_v = t_h \times k_r$
 $t_v = 600 \text{ ms} \times 1.1 = 660 \text{ ms}$

Stroke [mm]	Size	Advancing (k_a) ¹⁾	Retracting (k_r)
10	4, 6, 8, 10	0.95	1.1
	12, 16, 20, 25	0.95	1.2
30	4, 6, 8, 10	0.95	1.1
	12, 16, 20, 25	0.95	1.2
50	6, 8, 10, 12	0.9	1.1
	16, 20, 25	1.1	1.2
100	10, 12, 16, 20, 25	1	1.1
150	12, 16, 20, 25	1	1.1
200	20, 25	0.9	1.1

1) Downward

Mini slides DGSL

Technical data



Travel time t as a function of the effective load m and the cushioning P1 – horizontal mounting position

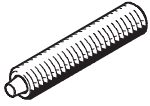

The values in the graphs are determined by calculation. The travel time as a function of effective load must not be reduced below

the values shown, because the kinetic impact or residual energy at the end positions can result in damage to the drive.

Vertical mounting position → 17

Advancing Stroke 10 mm, size 4 ... 10

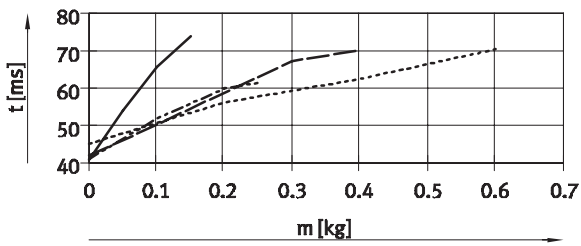

Retracting Stroke 10 mm, size 4 ... 10

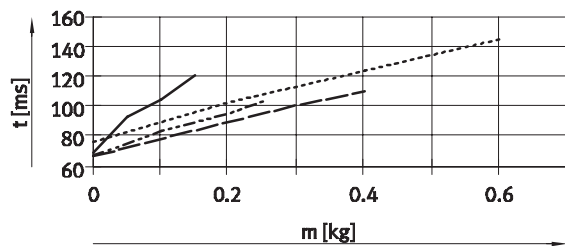

Stroke 10 mm, size 12 ... 16

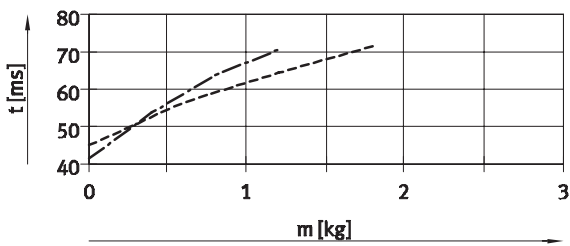

Stroke 10 mm, size 12 ... 16

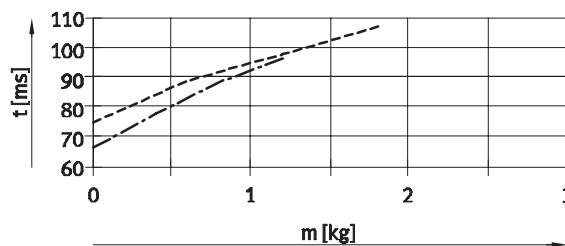

Stroke 10 mm, size 20 ... 25

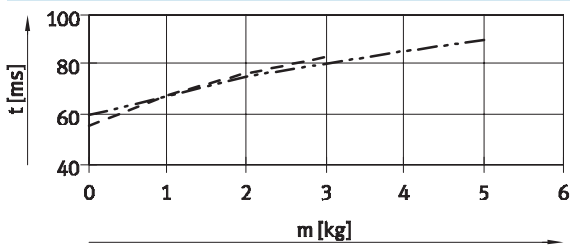

Stroke 10 mm, size 20 ... 25

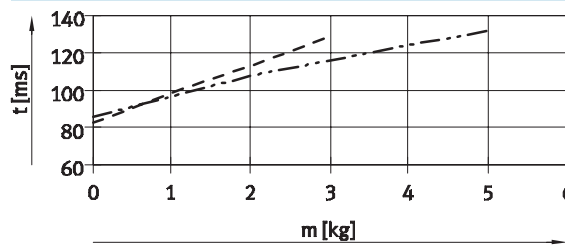

Stroke 30 mm, size 4 ... 10

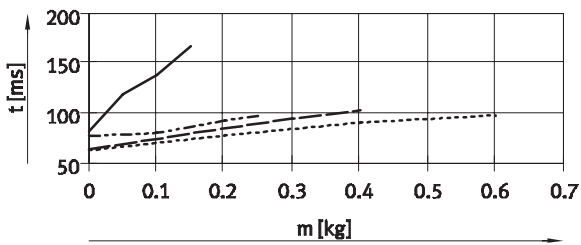

Stroke 30 mm, size 4 ... 10

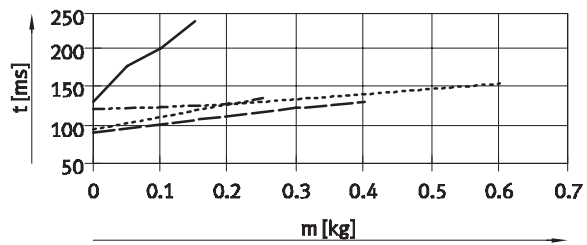

- | | | | |
|-----------|---------|-----------|---------|
| — | DGSL-4 | - - - - | DGSL-12 |
| - · - · - | DGSL-6 | - - - - - | DGSL-16 |
| - - - - | DGSL-8 | - - - - - | DGSL-20 |
| - · - · - | DGSL-10 | - - - - - | DGSL-25 |

Mini slides DGSL

Technical data



Travel time t as a function of the effective load m and the cushioning P1 – horizontal mounting position



The values in the graphs are determined by calculation. The travel time as a function of effective load must not be reduced below

the values shown, because the kinetic impact or residual energy at the end positions can result in damage to the drive.

Vertical mounting position
→ 17

Advancing

Stroke 30 mm, size 12 ... 16

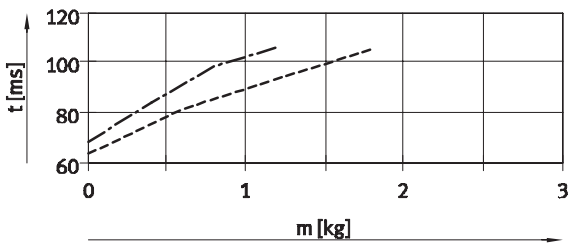

Retracting

Stroke 30 mm, size 12 ... 16

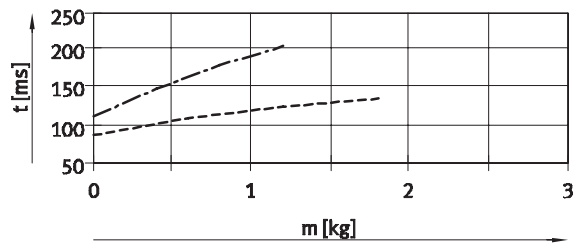

Stroke 30 mm, size 20 ... 25

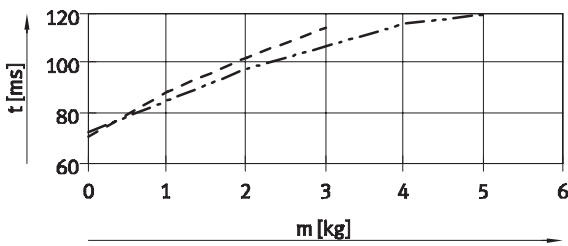

Stroke 30 mm, size 20 ... 25

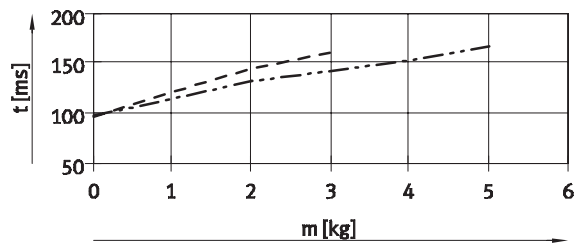

Stroke 50 mm, size 6 ... 12

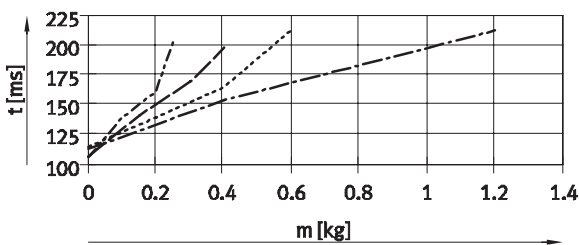

Stroke 50 mm, size 6 ... 12

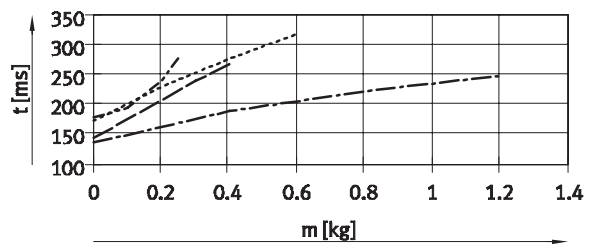

Stroke 50 mm, size 16 ... 25

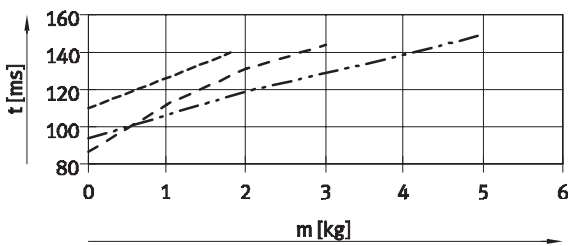

Stroke 50 mm, size 16 ... 25

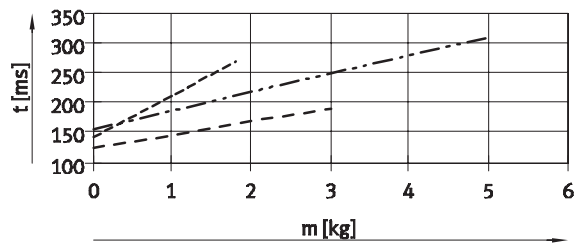

- | | | | |
|---------|---------|---------|---------|
| — | DGSL-4 | - - - - | DGSL-12 |
| - - - - | DGSL-6 | - - - - | DGSL-16 |
| - - - - | DGSL-8 | - - - - | DGSL-20 |
| - - - - | DGSL-10 | - - - - | DGSL-25 |

Mini slides DGSL

Technical data



Travel time t as a function of the effective load m and the cushioning P1 – horizontal mounting position



The values in the graphs are determined by calculation. The travel time as a function of effective load must not be reduced below

the values shown, because the kinetic impact or residual energy at the end positions can result in damage to the drive.

Vertical mounting position → 17

Advancing Stroke 100 mm, size 10 ... 16

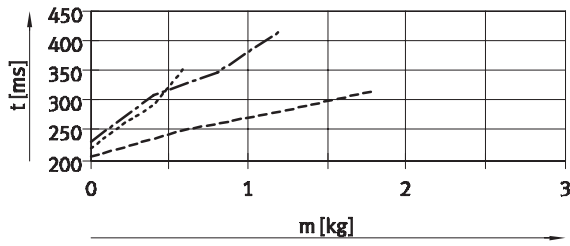

Retracting Stroke 100 mm, size 10 ... 25

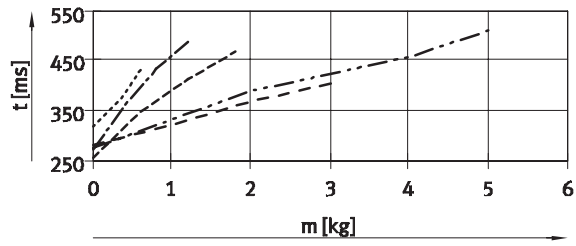

Stroke 100 mm, size 20 ... 25

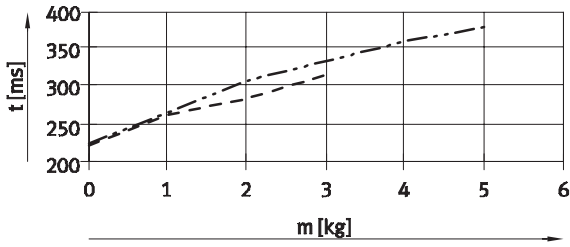

Stroke 150 mm, size 12 ... 25

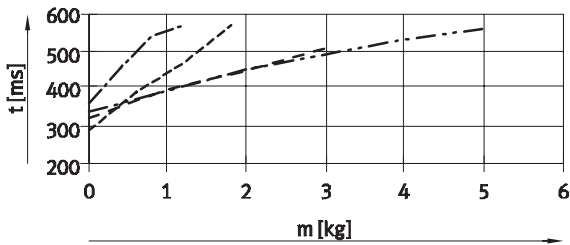

Stroke 150 mm, size 12 ... 25

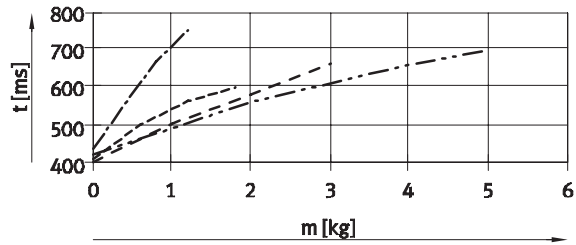

- | | |
|---------------|---------------|
| ————— DGSL-4 | ----- DGSL-12 |
| ----- DGSL-6 | ----- DGSL-16 |
| ----- DGSL-8 | ----- DGSL-20 |
| ----- DGSL-10 | ----- DGSL-25 |

Mini slides DGSL

Technical data

Travel time t as a function of the effective load m and the cushioning P1 – horizontal mounting position



The values in the graphs are determined by calculation. The travel time as a function of effective load must not be reduced below

the values shown, because the kinetic impact or residual energy at the end positions can result in damage to the drive.

Vertical mounting position → 17

Advancing

Stroke 200 mm, size 20

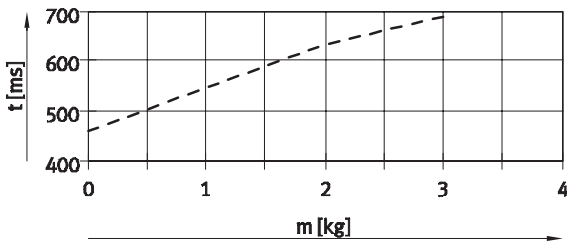

Retracting

Stroke 200 mm, size 20

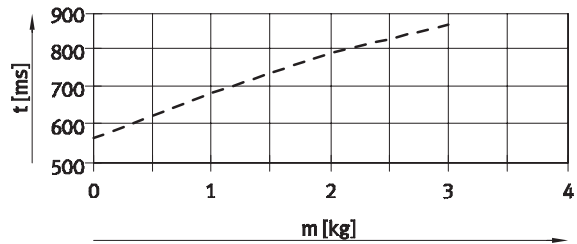

Stroke 200 mm, size 25

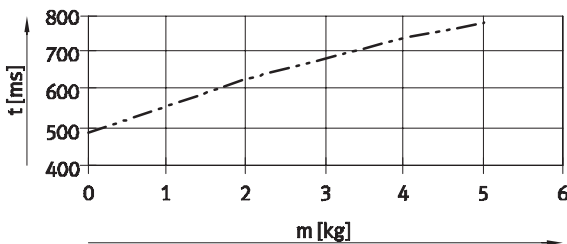

Stroke 200 mm, size 25

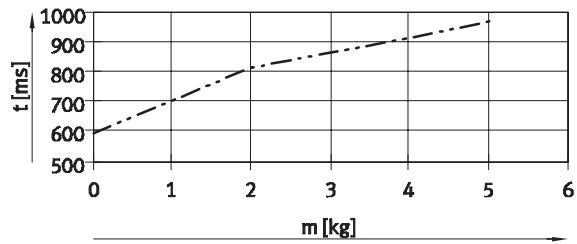

- DGSL-4
- - - - - DGSL-6
- DGSL-8
- - - - - DGSL-10
- - - - - DGSL-12
- - - - - DGSL-16
- - - - - DGSL-20
- - - - - DGSL-25

Vertical mounting position

The travel times for a vertical mounting position are calculated by multiplying the data ascertained for

horizontal mounting position by a correction factor k_a (advancing) and k_r (retracting), see adjacent table.

Given:

- Stroke = 200 mm
- Size = 20
- Effective load = 2 kg
- Ascertained travel time t_h (horizontal), see graph:
 - Advancing = 640 ms
 - Retracting = 780 ms

Calculated travel time t_v (vertical):

- Advancing: $t_v = t_h \times k_a$
 $t_v = 640 \text{ ms} \times 0.9 = 576 \text{ ms}$
- Retracting: $t_v = t_h \times k_r$
 $t_v = 780 \text{ ms} \times 1.1 = 858 \text{ ms}$

Stroke [mm]	Size	Advancing (k_a) ¹⁾	Retracting (k_r)
10	4, 6, 8, 10	1	1.1
	12, 16, 20, 25	1.1	1.2
30	4, 6, 8, 10	1	1.1
	12, 16, 20, 25	1.1	1.2
50	6, 8, 10, 12	1	1.1
	16, 20, 25	0.9	1.1
100	10, 12, 16, 20, 25	0.95	1.1
150	12, 16, 20, 25	0.95	1.1
200	20, 25	0.9	1.1

1) Downward

Mini slides DGSL

Technical data



Travel time t as a function of the effective load m and the cushioning Y3 – horizontal mounting position

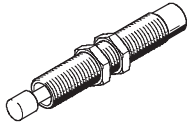

The values in the graphs are determined by calculation.
The travel time as a function of effective load must not be reduced below

the values shown, because the kinetic impact or residual energy at the end positions can result in damage to the drive.

Vertical mounting position
→ 20

Advancing Stroke 30 mm, size 8 ... 12

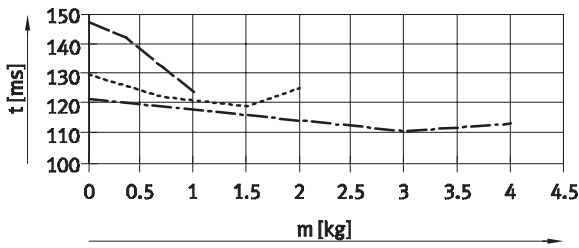

Retracting Stroke 30 mm, size 8 ... 12

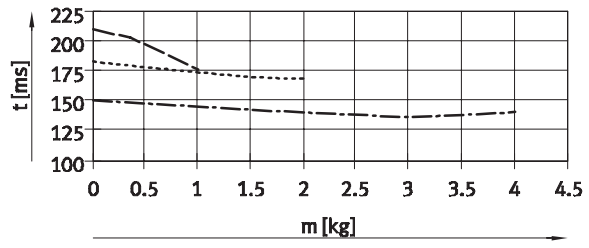

Stroke 30 mm, size 16 ... 25

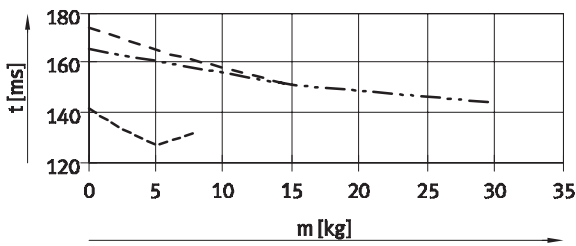

Stroke 30 mm, size 16 ... 25

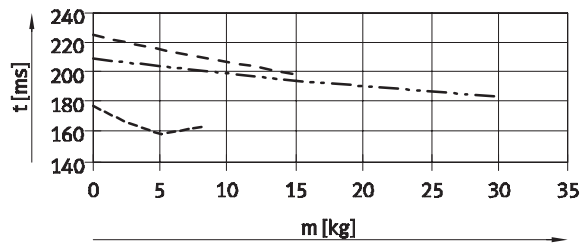

Stroke 50 mm, size 8 ... 12

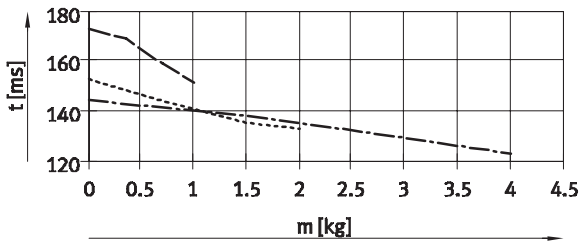

Stroke 50 mm, size 8 ... 12

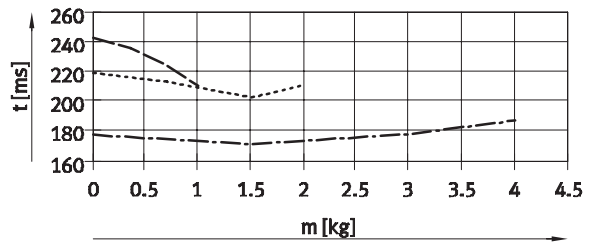

Stroke 50 mm, size 16 ... 25

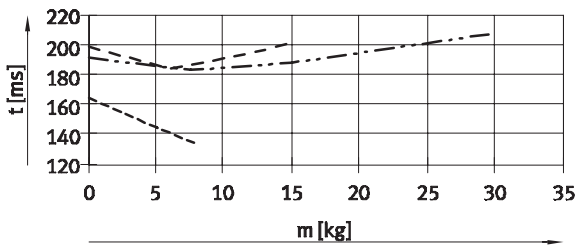

Stroke 50 mm, size 16 ... 25

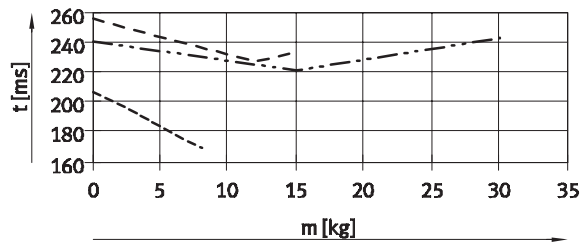

- DGSL-8
- DGSL-10
- DGSL-12
- DGSL-16
- - - DGSL-20
- · - · DGSL-25

Mini slides DGSL

Technical data

Travel time t as a function of the effective load m and the cushioning Y3 – horizontal mounting position

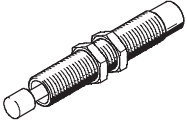

The values in the graphs are determined by calculation. The travel time as a function of effective load must not be reduced below

the values shown, because the kinetic impact or residual energy at the end positions can result in damage to the drive.

Vertical mounting position
→ 20

Advancing

Stroke 100 mm, size 10 ... 25

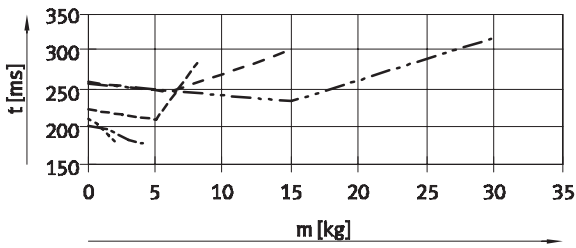

Retracting

Stroke 100 mm, size 10 ... 25

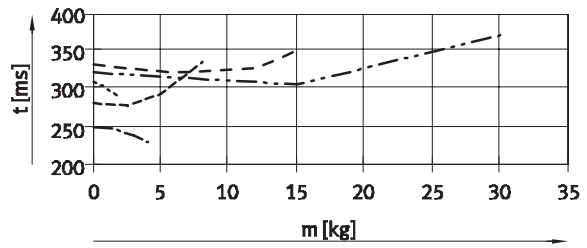

Stroke 150 mm, size 12 ... 25

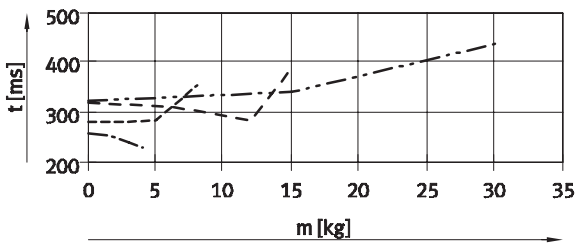

Stroke 150 mm, size 12 ... 25

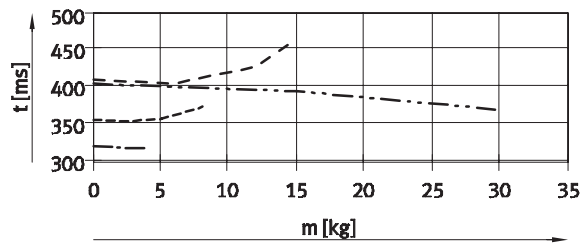

Stroke 200 mm, size 20 ... 25

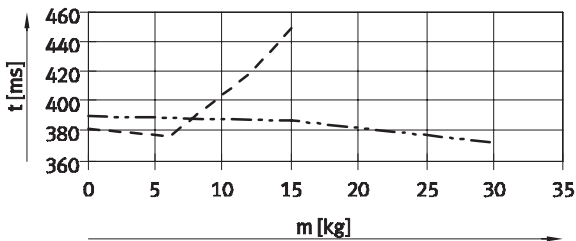

Stroke 200 mm, size 20 ... 25

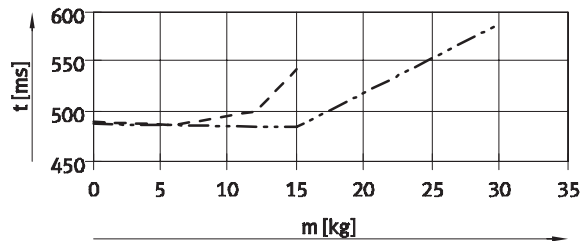

- DGSL-8
- - - DGSL-10
- · - DGSL-12
- - - DGSL-16
- - - DGSL-20
- · - DGSL-25

Mini slides DGSL

Technical data

Travel time t as a function of the effective load m and the cushioning Y3 – horizontal mounting position

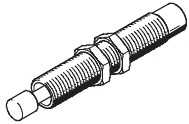

The values in the graphs are determined by calculation. The travel time as a function of effective load must not be reduced below

the values shown, because the kinetic impact or residual energy at the end positions can result in damage to the drive.

Vertical mounting position
→ 20

Vertical mounting position

The travel times for a vertical mounting position are calculated by multiplying the data ascertained for

horizontal mounting position by a correction factor ka (advancing) and kr (retracting), see adjacent table.

Given:

- Stroke = 200 mm
- Size = 20
- Effective load = 10 kg
- Ascertained travel time th (horizontal), see graph:
 - Advancing = 405 ms
 - Retracting = 490 ms

Calculated travel time tv (vertical):

- Advancing: $t_v = t_h \times k_a$
 $t_v = 405 \text{ ms} \times 0.9 = 365 \text{ ms}$
- Retracting: $t_v = t_h \times k_r$
 $t_v = 490 \text{ ms} \times 1.5 = 735 \text{ ms}$

Stroke [mm]	Size	Advancing (ka) ¹⁾	Retracting (kr)
30	8, 10, 12	0.95	1.2
	16, 20, 25	0.9	1.5
50	8, 10, 12	0.9	1.5
	16, 20, 25	0.9	1.5
100	10, 12, 16, 20, 25	0.8	1.5
150	12, 16, 20, 25	0.9	1.5
200	20, 25	0.9	1.5

1) Downward

Mini slides DGSL

Technical data

Dynamic specific load values

Torques are indicated with reference to the centre of the guide. They must not be exceeded in operational use. Special attention must be paid to the cushioning phase.

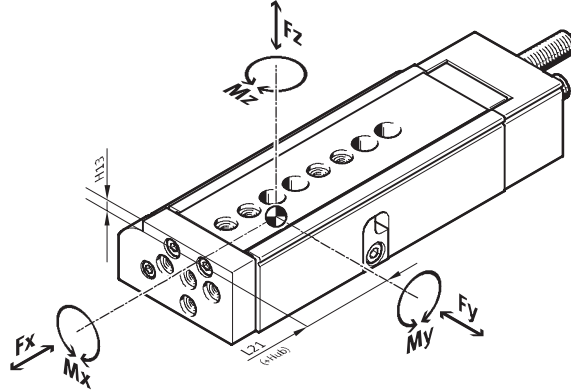

If the drive is subjected to more than two of the indicated forces and torques simultaneously, the following equation must be satisfied in addition to the indicated maximum loads:

$$\frac{|F_{y1}|}{F_{y_{max}}} + \frac{|F_{z1}|}{F_{z_{max}}} + \frac{|M_{x1}|}{M_{x_{max}}} + \frac{|M_{y1}|}{M_{y_{max}}} + \frac{|M_{z1}|}{M_{z_{max}}} \leq 1$$

Position of the guide centre

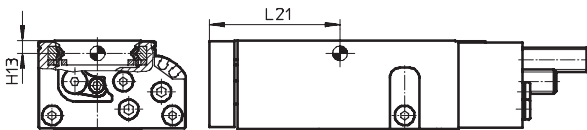

Calculation example

Given:

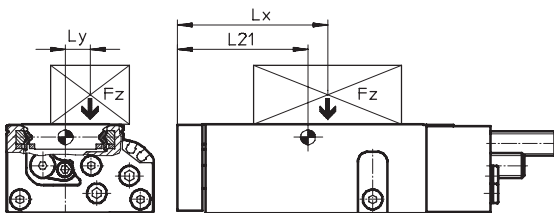

Mini slide	= DGSL-10
Stroke length	= 80 mm
Lever arm L _x	= 50 mm
Lever arm L _y	= 30 mm
Weight F _z	= 0.8 kg
Acceleration a	= 0 m/s ²

To be calculated:

F_y, F_z, M_x, M_y, M_z
and
verification of operation with
combined load

Solution:

L₂₁ = 83 mm from table

F_y = 0 N

F_z = m x g
= 0.8 kg x 9.81 m/s² = 7.848 N

M_x = m x g x L_y
= 0.8 kg x 9.81 m/s² x 30 mm = 0.236 Nm

M_y = m x g x [(L₂₁+stroke)-L_x]
= 0.8 kg x 9.81 m/s² x [(83 mm + 80 mm) - 50 mm] = 0.886 Nm

M_z = 0 Nm

Combined load:

$$\frac{|F_{y1}|}{F_{y_{max}}} + \frac{|F_{z1}|}{F_{z_{max}}} + \frac{|M_{x1}|}{M_{x_{max}}} + \frac{|M_{y1}|}{M_{y_{max}}} + \frac{|M_{z1}|}{M_{z_{max}}} = 0 + \frac{7.848\text{N}}{1200\text{N}} + \frac{0.236\text{Nm}}{18\text{Nm}} + \frac{0.886\text{Nm}}{12\text{Nm}} + 0 = 0.094 \leq 1$$

Forces and torques

→ 22

Mini slides DGSL

Technical data



Permissible forces and torques						Geometric characteristics	
Size	Stroke	F _y max [N]	F _z max [N]	M _x max [Nm]	M _y max, M _z max [Nm]	H13 [mm]	L21 [mm]
4							
	10	343	343	2	2	2.7	31
	20	368	368	2	2		36
	30	387	387	2	2		42
6							
	10	540	540	6	4.5	3.4	37
	20	590	590	7	5		42
	30	631	631	8	5.5		47
	40	677	677	8	5.5		52
	50	719	719	8	5.5		57
8							
	10	657	657	7	5.5	3.25	41
	20	745	745	8	5.5		46
	30	850	850	9	5.5		51
	40	934	934	10	5.5		56
	50	962	962	10	8		67
	80	971	971	10	8		82
10							
	10	927	927	15	6	4.2	43
	20	1003	1003	15	7		46
	30	1078	1078	15	8		51
	40	1152	1152	15	9		56
	50	1175	1175	18	9		61
	80	1200	1200	18	12		83
	100	1250	1250	18	12		96
12							
	10	942	942	15	8	5.2	44
	20	1006	1006	15	9		49
	30	1075	1075	15	10		54
	40	1142	1142	18	11		59
	50	1200	1200	18	12		64
	80	1280	1280	20	15		88
	100	1340	1340	20	15		98
	150	1400	1400	20	15		124
16							
	10	1769	1769	35	20	6.4	54
	20	2021	2021	35	22		59
	30	2274	2274	35	22		64
	40	2527	2527	40	25		69
	50	2780	2780	40	25		74
	80	2800	2800	50	27		89
	100	2850	2850	50	43		113
	150	2900	2900	50	43		138

Mini slides DGSL

Technical data



Permissible forces and torques						Geometric characteristics	
Size	Stroke	$F_{y_{max}}$ [N]	$F_{z_{max}}$ [N]	$M_{x_{max}}$ [Nm]	$M_{y_{max}}, M_{z_{max}}$ [Nm]	H13 [mm]	L21 [mm]
20							
	10	2911	2911	60	30	7.55	56
	20	3143	3143	60	30		61
	30	3354	3354	60	30		66
	40	3612	3612	60	40		71
	50	3816	3816	70	50		76
	80	4032	4032	80	50		91
	100	4200	4200	85	80		121
	150	4400	4400	90	80		152
	200	4600	4600	90	80		177
25							
	10	3270	3270	100	60	8.55	64
	20	3744	3744	100	60		69
	30	4205	4205	100	60		74
	40	4643	4643	110	60		79
	50	4650	4650	120	60		84
	80	4700	4700	130	80		112
	100	4750	4750	130	80		129
	150	4800	4800	130	80		154
	200	4800	4800	130	80		179

Parallelism

The term parallelism refers to the accuracy of alignment between the mounting surface and the slide surface.

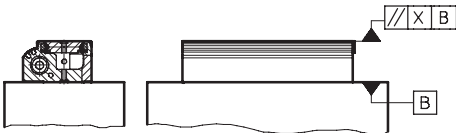

Size	Stroke	4	6	8	10	12	16	20	25
Parallelism X	10	0.02	0.02	0.02	0.02	0.02	0.02	0.02	0.02
	20	0.02	0.02	0.02	0.02	0.025	0.025	0.025	0.025
	30	0.025	0.025	0.025	0.025	0.025	0.025	0.03	0.03
	40	-	0.025	0.025	0.025	0.03	0.03	0.035	0.035
	50	-	0.03	0.03	0.03	0.035	0.035	0.04	0.04
	80	-	-	0.035	0.035	0.04	0.04	0.045	0.045
	100	-	-	-	0.045	0.05	0.05	0.055	0.055
	150	-	-	-	-	0.075	0.075	0.08	0.08
	200	-	-	-	-	-	-	0.08	0.08

Linearity

The term linearity refers to the accuracy of alignment between the mounting surface and the slide surface as a function of the stroke.

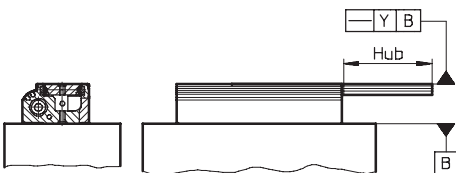

Linear travel accuracy y as a function of the stroke length l

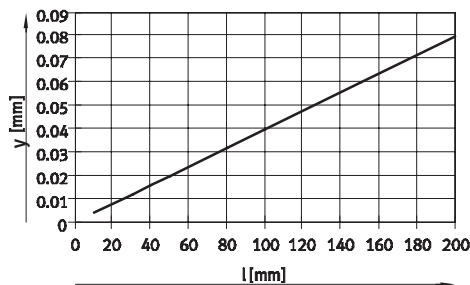

Mini slides DGSL

Technical data



Possible combinations without adapter plate

Pick & place

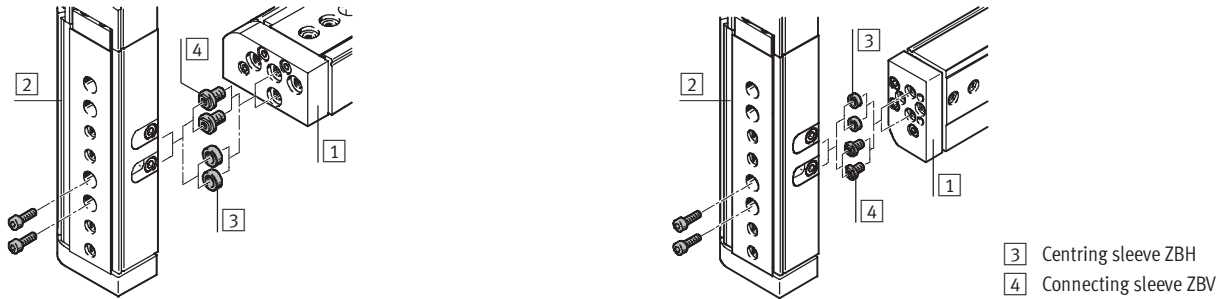

Piggy-back assembly



Example of mounting with connecting sleeve ZBV

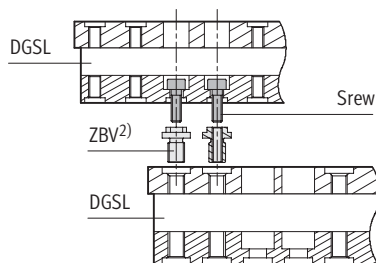

		1 Basic drive								
		Size	4	6	8	10	12	16	20	25
2 Assembly drive	4	2x M3x7 2x ZBH-5 ¹⁾	2x M3x10 2x ZBH-5 ¹⁾	ZBV-M4-7 ²⁾	ZBV-M4-7 ²⁾	-	-	-	-	-
	6	-	2x M3x10 2x ZBH-5 ¹⁾	ZBV-M4-7 ²⁾	ZBV-M4-7 ²⁾	-	-	-	-	-
	8	-	-	2x M4x12 2x ZBH-7 ¹⁾	2x M4x12 2x ZBH-7 ¹⁾	ZBV-M5-7 ²⁾	ZBV-M5-7 ²⁾	-	-	-
	10	-	-	-	2x M4x14 2x ZBH-7 ¹⁾	ZBV-M5-7 ²⁾	ZBV-M5-7 ²⁾	-	-	-
	12	-	-	-	-	2x M5x14 2x ZBH-7 ¹⁾	2x M5x16 2x ZBH-7 ¹⁾	ZBV-M6-9 ²⁾	ZBV-M6-9 ²⁾	-
	16	-	-	-	-	-	2x M5x18 2x ZBH-7 ¹⁾	ZBV-M6-9 ²⁾	ZBV-M6-9 ²⁾	-
	20	-	-	-	-	-	-	2x M6x20 2x ZBH-9 ¹⁾	2x M6x20 2x ZBH-9 ¹⁾	-
	25	-	-	-	-	-	-	-	2x M6x30 2x ZBH-9 ¹⁾	-

1) Centring sleeves ZBH are included in the scope of delivery of the mini slide DGSL

2) Connecting sleeves ZBV → 42

Mini slides DGSL

Technical data

Adjustable end position range

Coarse adjustment of the front end position

The mini slide DGSL allows the front fixed stop to be adjusted by removing the cover.

This permits stroke reduction down to the next but one smaller standard stroke.

Advantages:

- Can be flexibly adapted to the application
- Integrated, which means fewer conversion overheads
- Large setting range

 Note
Removal of the fixed stops can result in the destruction of the mini slide DGSL.

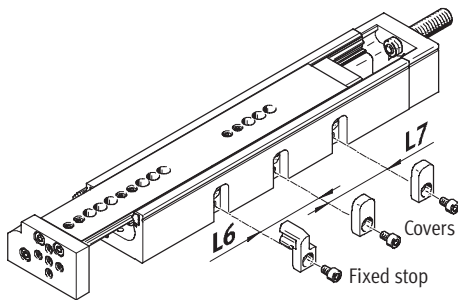

Size/ stroke	4		6		8		10		12		16		20		25	
	L6	L7	L6	L7	L6	L7	L6	L7	L6	L7	L6	L7	L6	L7	L6	L7
10	-	-	-	-	-	-	-	-	-	-	-	-	-	-	-	-
20	10	-	14	-	10	-	-	-	-	-	-	-	-	-	-	-
30	10	-	14	-	10	-	-	-	-	-	-	-	-	-	-	-
40	-	-	14	-	10	-	-	-	-	-	-	-	-	-	-	-
50	-	-	14	14	10	-	-	-	-	-	-	-	-	-	-	-
80	-	-	-	-	10	10	24	-	29	-	35	-	-	-	55	-
100	-	-	-	-	-	-	24	24	29	-	35	-	44	-	55	-
150	-	-	-	-	-	-	-	-	29	29	35	-	44	-	55	-
200	-	-	-	-	-	-	-	-	-	-	-	-	44	44	55	-

Example:

DGSL-12-150-...

Max. stroke = 150 mm

By setting the fixed stop by the dimensions L6:

Stroke = 150 - 29 = 121 mm

By setting the fixed stop by the dimensions L6 and L7:

Stroke = 150 - 29 - 29 = 92 mm

Precision adjustment of the front and rear end position

The stroke can be precisely adjusted using the cushioning components (on the slide and in the end cap).

Step 1:

Loosen the clamping component.

Step 2:

Position the slide by hand in the desired end position.

Step 3:

Turn the end-stop component using an Allen key until the end position is reached.

Step 4:

Tighten the clamping component.

Step 1

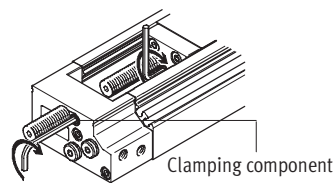

Step 2 ... 4

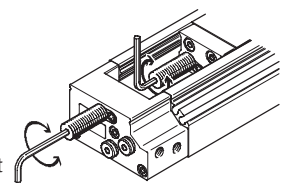

Adjustable end position range [mm] per end position									
Size		4	6	8	10	12	16	20	25
Front end position									
With cushioning	P	14.5	16.5	19.5	27.5	27.5	37.5	50.5	53.5
	P1	14.5	16.5	19.5	27.5	27.5	37.5	50.5	53.5
	Y3	-	-	15	22.5	27.5	36.5	43	56
Rear end position									
With cushioning	P	13.5	15	18.5	20	25.5	39.5	49.5	49
	P1	13.5	15	18.5	20	25.5	39.5	49.5	49
	Y3	-	-	14	15	25.5	38.5	42	51.5

Mini slides DGSL

Technical data



Dimensions Download CAD data → www.festo.com/en/engineering

Size 4 ... 10

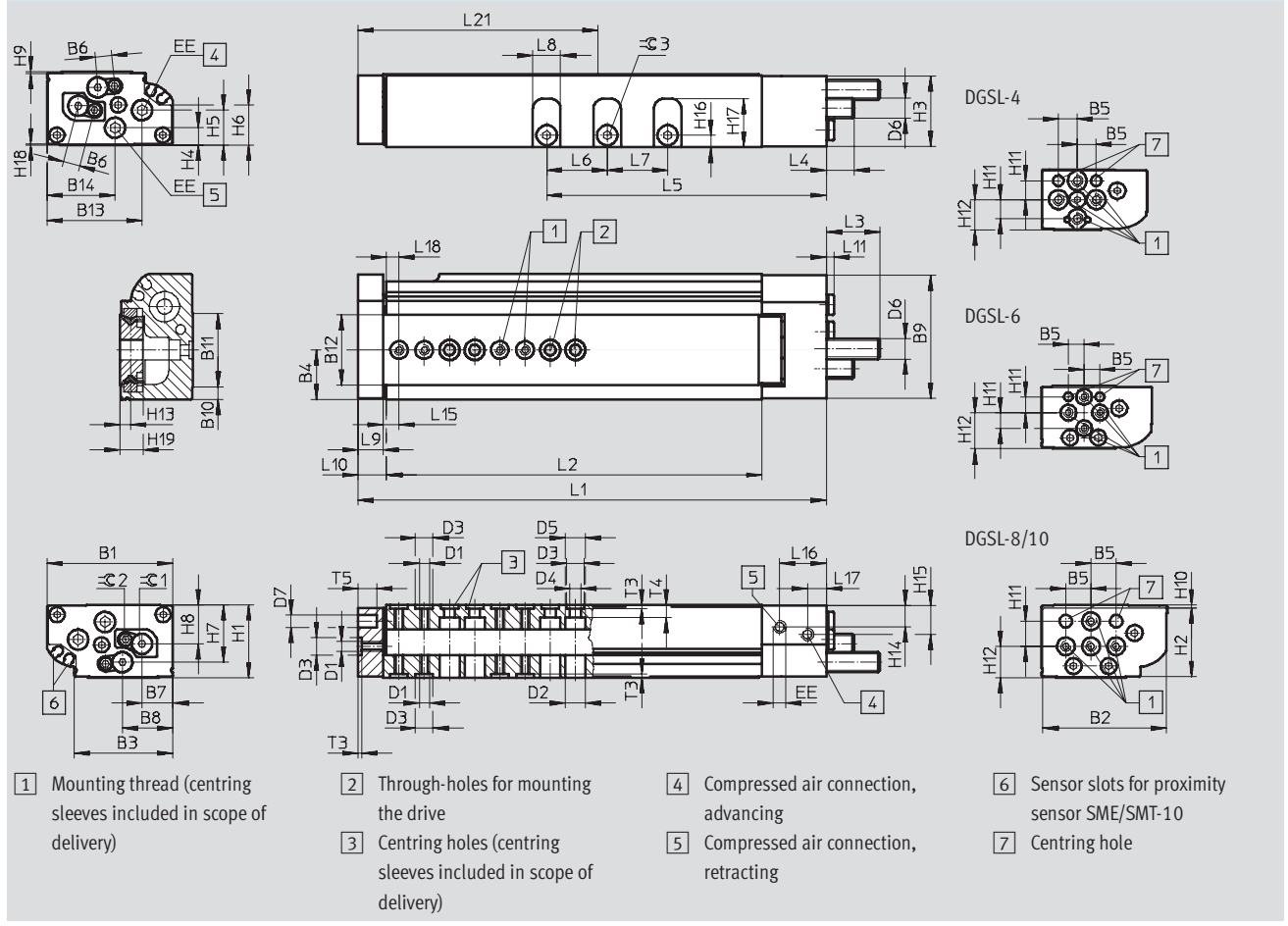

General dimensions

Size	B1	B2	B3	B4	B5	B6	B7	B8	B9	B10	B11	B12	B13	B14	D1
4	28	27.4	18.1	9.4	5	3.55	6.3	11.95	27.5	2	17.2	12.4	23.15	16.15	M3
6	35	34.5	26	13.5	5	5	8.2	13.5	34.5	3.5	19.9	20	28.1	18.9	M3
8	42	41.3	31.2	16.6	10	6	10.3	16.25	41.5	4.5	24	24.1	33	24.4	M4
10	50	49	39.2	19.65	10	6.8	12.35	20.1	49	5	29.2	28	37.7	27	M4

Size	D2	D3	D4	D5	D6	D7	EE	H1	H2	H3	H4	H5	H6	H7	H8
	∅	∅	∅	∅		∅		±0.08							
4	6.2	5 ^{H7}	3.3	6	M4x0.5	3 ^{H7}	M3	16	15.4	15.1	3.85	6.3	8.6	8.4	8.1
6	6.2	5 ^{H7}	3.3	6	M5x0.5	3 ^{H7}	M3	20	19	19.25	4.7	7.8	10.2	16	10.55
8	8	7 ^{H7}	4.3	8	M6x0.5	5 ^{H7}	M3	24	22.7	23	6.5	10.6	14	18.9	13.3
10	8	7 ^{H7}	4.3	8	M8x1	5 ^{H7}	M5	29	27.1	28	6.8	13.8	15.8	22.8	15.5

Size	H9	H10	H11	H12	H13	H14	H15	H16	H17	H18	H19	T3	T4	T5	∅ 2	∅ 3
												+0.1				
4	0.65	0.3	5	8	2.7	5.35	5.85	3	10.6	0.25	5.3	1.3	2.3	4	1.3	2
6	0.5	0.5	5	11.5	3.4	6.5	7.2	3.7	13.1	0.27	6.5	1.3	3.3	6	1.5	2.5
8	0.6	0.9	10	8.7	3.25	7.8	10.5	4.1	16.8	0.35	6.6	1.6	3.8	7.5	2	2.5
10	0.6	1.4	10	12.5	4.2	8.75	11.75	4.8	19.25	0.4	9	1.6	5	7.5	2.5	3

Mini slides DGSL

Technical data



Stroke-dependent dimensions															
Size	Stroke	L1	L2	L5	L6	L7	L8	L9	L10	L11	L15 ±0.05	L16	L17	L18 ±0.05	L21
4	10	72.1	48	36.35	–	–	6.5	5.5	6.6	2.5	4	13.25	4.95	3	31
	20	81.2	57.1	37.95	10	36									
	30	91.2	67.1	47.95	11	42									
6	10	81.1	54	33.1	–	14	8	8	9.6	2.5	5.1	13.25	4.95	3.5	37
	20	91.1	64	43.1	14										42
	30	101.1	74	53.1	14										47
	40	111.1	84	63.1	14										52
	50	121.1	94	73.1	14										57
8	10	90.2	59.6	34.6	–	–	8	10	11.6	2.5	7	14.65	6.1	5.5	41
	20	100.2	69.6	44.6	10	46									
	30	110.2	79.6	54.6	16	51									
	40	120.2	89.6	64.6	16	56									
	50	142.2	111.6	74.6	16	67									
	80	172.2	141.6	104.6	10	82									
10	10	103.1	66	41.3	–	–	11	10	11.6	2.5	6.4	18.5	7.5	5	43
	20	112.8	75.7	51	–	46									
	30	122.8	85.7	61	–	51									
	40	132.8	95.7	71	–	56									
	50	142.8	105.7	81	–	61									
	80	186.2	149.1	111	24	83									
	100	206.2	169.1	131	24	24									96

Cushioning-dependent dimensions					
Size	Cushioning	L3 max.	L4 max.	≈ 1	
				For adjusting the cushioning stroke	For adjusting the end position
4	P	15.2	7.8	–	1.3
	P1	14	6	1.3	2.5
6	P	17.6	8.1	–	1.5
	P1	15.5	5.8	1.5	3
8	P	21.1	10.7	–	2
	P1	19	9.1	2	4
	Y3	24.3	23.9	–	2
10	P	22.8	12.5	–	2.5
	P1	20.5	10.2	2.5	5
	Y3	25.5	14.9	–	2.5

Mini slides DGSL

Technical data

FESTO

Hole pattern for mounting threads and centring holes

DGSL-4-10

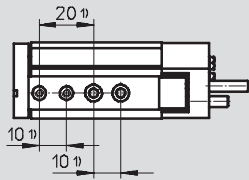

DGSL-4-20

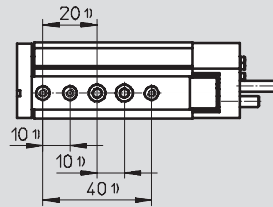

DGSL-4-30

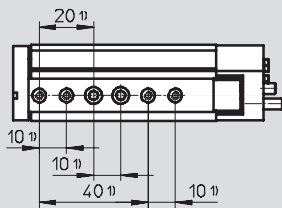

DGSL-6-10

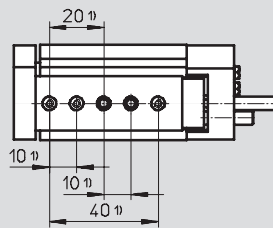

DGSL-6-20

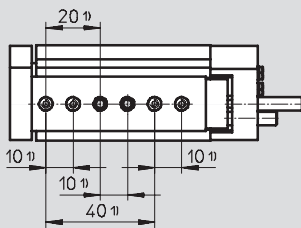

DGSL-6-30

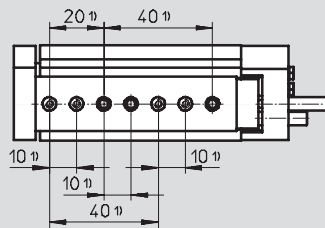

DGSL-6-40/50

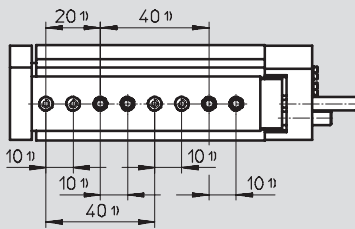

DGSL-8-10

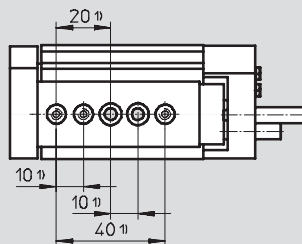

DGSL-8-20

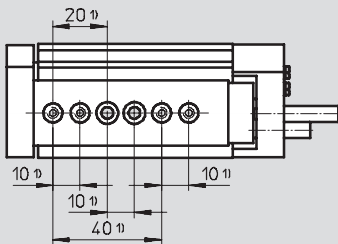

DGSL-8-30

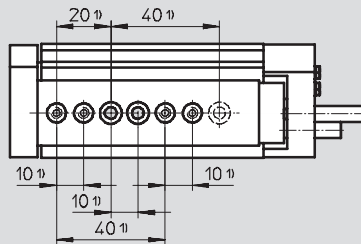

Mini slides DGSL

Technical data

Hole pattern for mounting threads and centring holes

DGSL-8-40

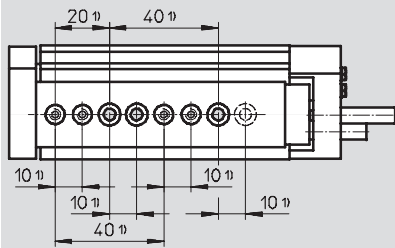

DGSL-8-50/80

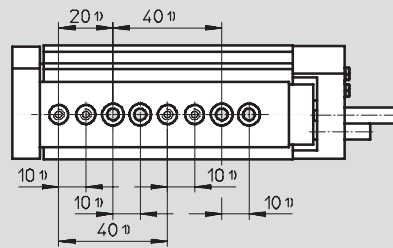

DGSL-10-10

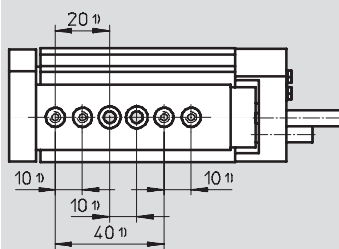

DGSL-10-20

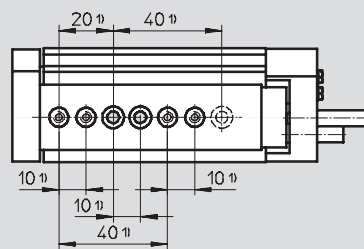

DGSL-10-30

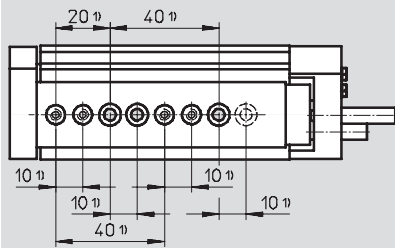

DGSL-10-40 ... 100

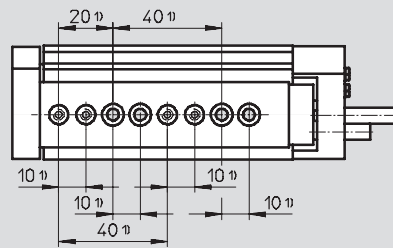

Distances from the yoke plate to the mounting threads and centring holes

DGSL-4 ... 10

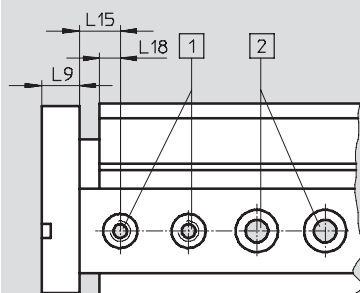

- 1) Centring holes with thread
- 2) Through-holes for mounting the drive
- 1) Tolerance for centring hole ± 0.02
- Tolerance for through-hole ± 0.1

Size	L9	L15 ± 0.05	L18
4	5.5	4	3
6	8	5.1	3.5
8	10	7	5.5
10	10	6.4	5

Mini slides DGSL

Technical data



Dimensions

Download CAD data → www.festo.com/en/engineering

Size 12/16

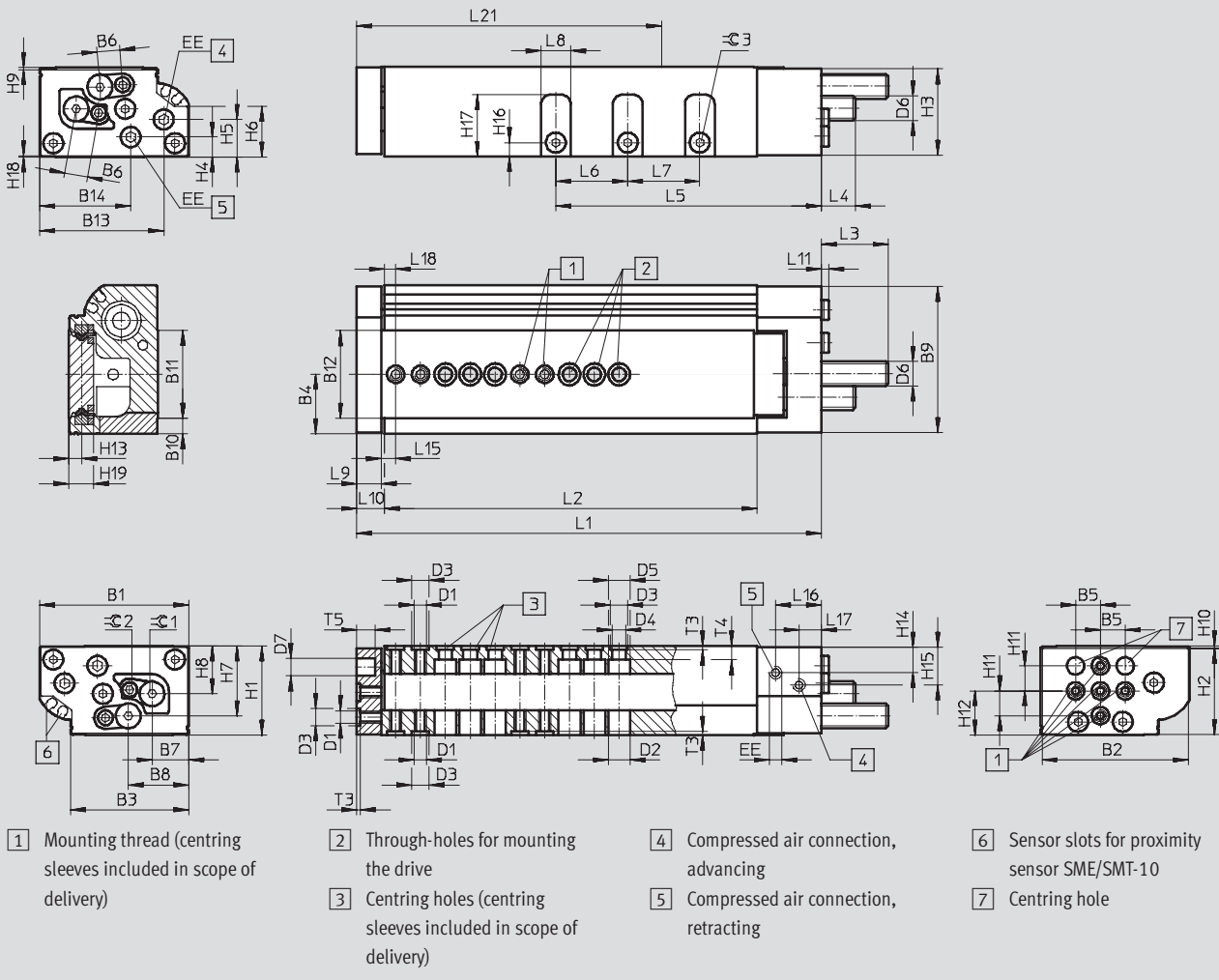

General dimensions

Size	B1	B2	B3	B4	B5	B6	B7	B8	B9	B10	B11	B12	B13	B14	D1
12	60	59	47.6	24	10	9.2	14.7	24.3	59	6.4	35.35	35.2	50	36.7	M5
16	66	65	53.5	26.7	10	11.1	16.7	27.5	65	7.75	37.9	38	50.4	36.7	M5

Size	D2	D3	D4	D5	D6	D7	EE	H1	H2	H3	H4	H5	H6	H7	H8
	∅	∅	∅	∅		∅		±0.08							
12	8.8	7 ^{H7}	5.5	8.8	M10x1	8 ^{H7}	M5	36	34.8	34.7	8	15.1	20.35	28.2	19.3
16	8.8	7 ^{H7}	5.5	9.2	M12x1	8 ^{H7}	M5	40	38	39	8.5	16.7	20.6	31.7	20.8

Size	H9	H10	H11	H12	H13	H14	H15	H16	H17	H18	H19	T3	T4	T5	∠2	∠3
												+0.1				
12	0.8	0.95	10	17.9	5.2	10.75	15.75	5.5	24.9	0.5	10	1.6	5.6	7.5	3	3
16	0.5	1.5	10	20	6.4	10.5	16.7	7	26.6	0.5	12.4	1.6	6.1	9	4	4

Mini slides DGSL

Technical data



Stroke-dependent dimensions															
Size	Stroke	L1	L2	L5	L6	L7	L8	L9	L10	L11	L15 ±0.05	L16	L17	L18 ±0.05	L21
12	10	106.2	68.6	42.4	-	-	12	10	11.6	2.5	5.8	18.5	9	4.5	44
	20	116.2	78.6	52.4											49
	30	126.2	88.6	62.4											54
	40	136.2	98.6	72.4											59
	50	146.2	108.6	82.4											64
	80	197.6	160	117	29	29	88								
	100	217.6	180	137	98										
	150	267.6	230	187	124										
16	10	124.1	82.5	45	-	-	14	12	13.6	2.5	6.8	21	10	5.5	54
	20	134.6	93	54.6											59
	30	144.6	103	64.6											64
	40	154.6	113	74.6											69
	50	164.6	123	84.6											74
	80	194.6	153	114.6	35	35	89								
	100	243.6	202	134.6	113										
	150	293.6	252	184.6	138										

Cushioning-dependent dimensions					
Size	Cushioning	L3 max.	L4 max.	≈ 1	
				For adjusting the cushioning stroke	For adjusting the end position
12	P	28.1	14.9	-	3
	P1	26	12.8	3	6
	Y3	36.9	23.7	-	3
16	P	42.3	26.1	-	4
	P1	40	23.8	4	8
	Y3	51.9	35.7	-	4

Mini slides DGSL

Technical data

FESTO

Hole pattern for mounting threads and centring holes

DGSL-12-10

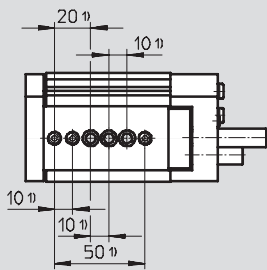

DGSL-12-20

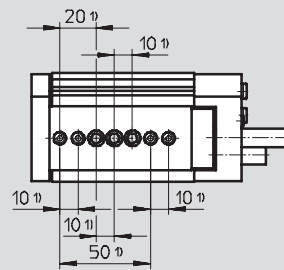

DGSL-12-30

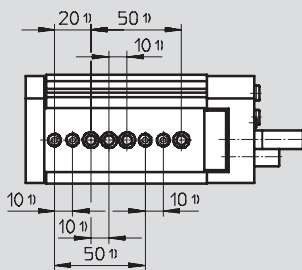

DGSL-12-40

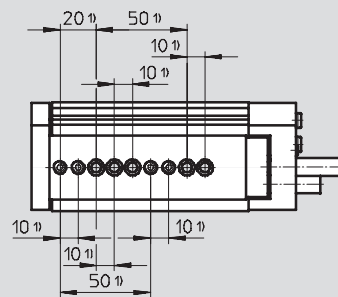

DGSL-12-50 ... 100

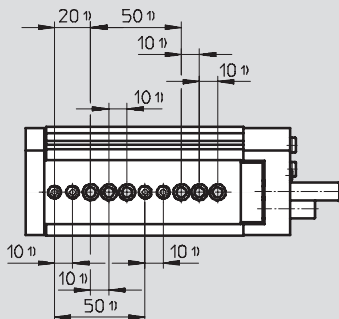

DGSL-12-150

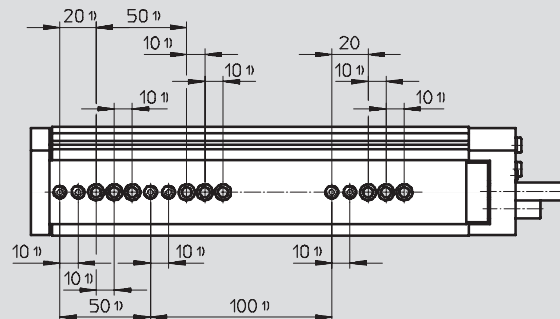

DGSL-16-10

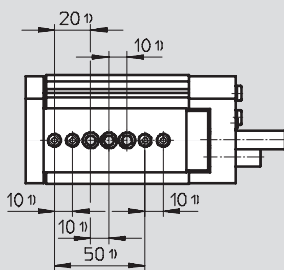

DGSL-16-20

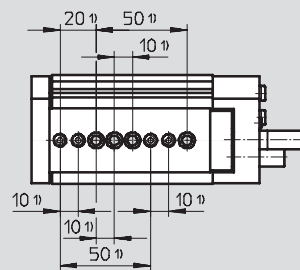

Mini slides DGSL

Technical data

Hole pattern for mounting threads and centring holes

DGSL-16-30

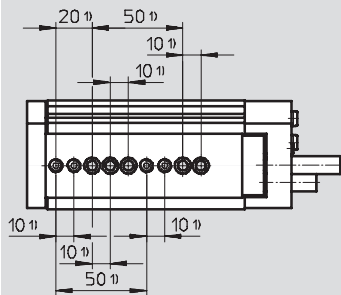

DGSL-16-40 ... 100

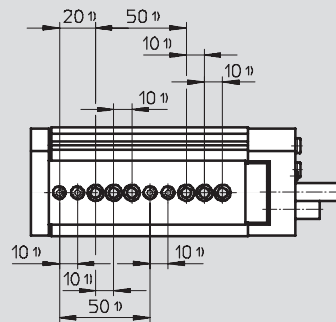

DGSL-16-150

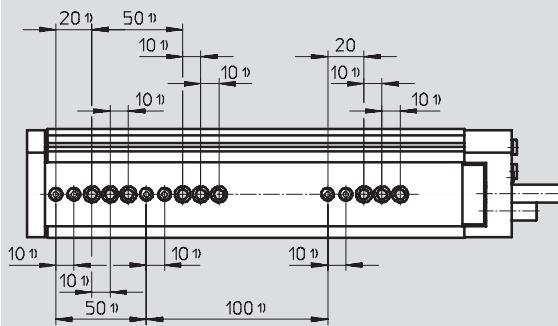

Distances from the yoke plate to the mounting threads and centring holes

DGSL-12/16

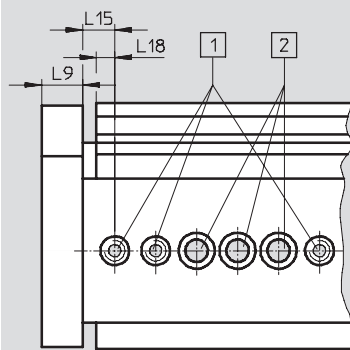

- 1 Centring holes with thread
 - 2 Through-holes for mounting the drive
- 1) Tolerance for centring hole ± 0.02
Tolerance for through-hole ± 0.1

Size	L9	L15 ± 0.05	L18
12	10	5.8	4.5
16	12	6.8	5.5

Mini slides DGSL

Technical data



Dimensions

Download CAD data → www.festo.com/en/engineering

Size 20/25

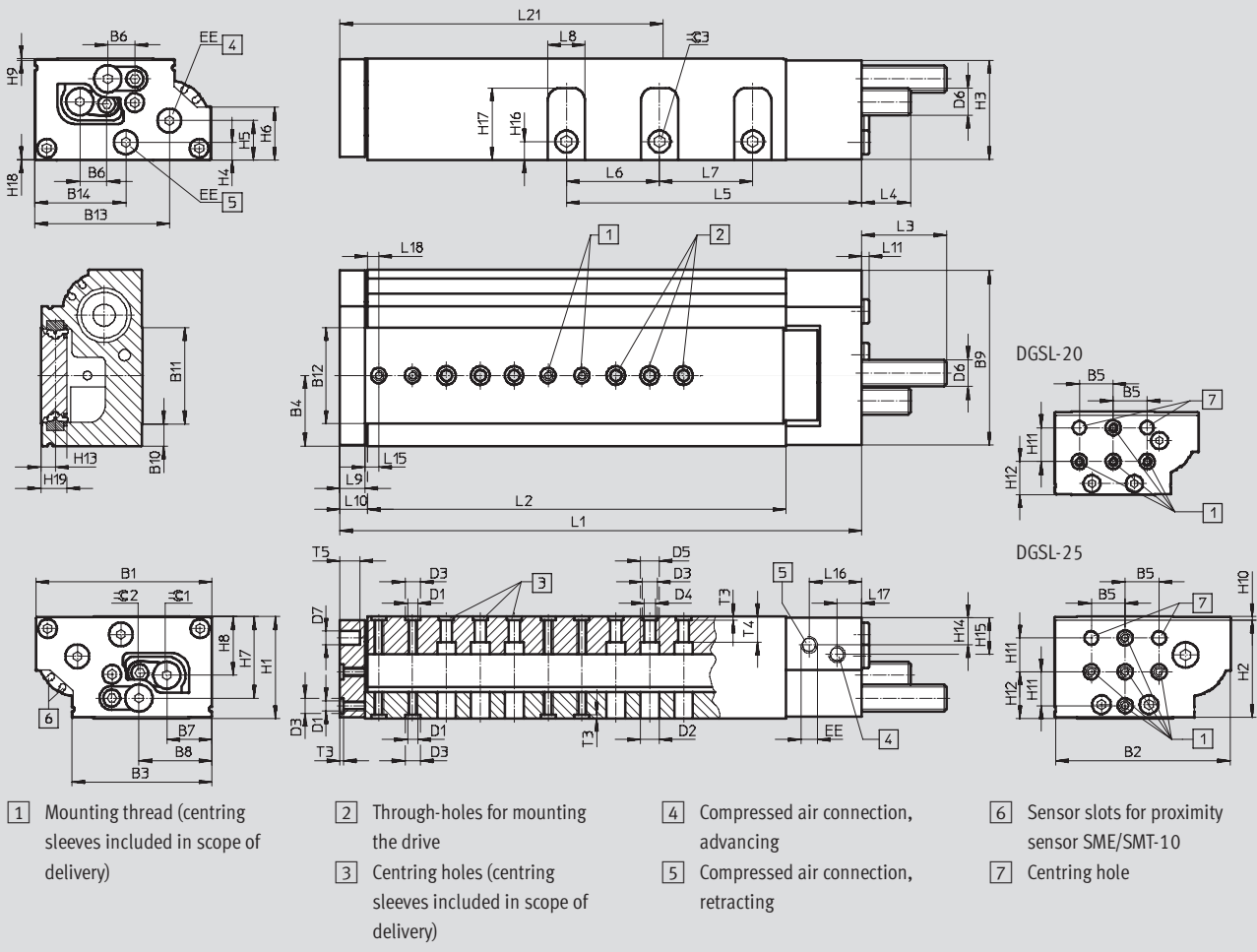

General dimensions

Size	B1	B2	B3	B4	B5	B6	B7	B8	B9	B10	B11	B12	B13	B14	D1
20	85	84	68.85	34.5	20	14	21.4	36.35	83.4	10	48.9	49.2	64.1	48.6	M6
25	104	103	82.6	41.6	20	16.2	26.6	43.1	103	13.25	56.5	56.7	79.4	53.7	M6

Size	D2	D3	D4	D5	D6	D7	EE	H1	H2	H3	H4	H5	H6	H7	H8
	∅	∅	∅	∅		∅		±0.08							
20	11	9 ^{H7}	6.6	11	M14x1	8 ^{H7}	G ¹ / ₈	49	46.5	47.7	10.3	20.6	23.2	38.2	26.1
25	11	9 ^{H7}	6.6	11	M16x1	8 ^{H7}	G ¹ / ₈	60	57.5	58.5	10.5	23.4	31.2	48	34.5

Size	H9	H10	H11	H12	H13	H14	H15	H16	H17	H18	H19	T3	T4	T5	≈ 2	≈ 3
20	0.5	2	20	19.6	7.55	14.7	14.7	10	33.3	0.8	14.5	2.1	8.8	10	4	5
25	1	2	20	27.5	8.55	16.6	22.2	11	42.7	0.5	15.5	2.1	15.1	12	5	6

Mini slides DGSL

Technical data



Stroke-dependent dimensions																	
Size	Stroke	L1	L1	L2	L5	L6	L7	L8	L9	L10	L11	L15 ±0.05	L16	L17	L18 ±0.05	L21	
20	10	141.2	140.9	84.6	59.1	-	-	17	14	15.6	4.6	7.8	29.3	12	6.5	56	
	20	151.2	150.9	94.6	69.1											61	
	30	161.2	160.9	104.6	79.1											66	
	40	171.2	170.9	114.6	89.1											71	
	50	183.2	182.9	126.6	99.1											76	
	80	211.2	210.9	154.6	129.1											91	
	100	270.2	269.9	213.6	149.1											44	121
	150	333.2	332.9	276.6	199.1											152	
	200	383.2	382.9	326.6	252.1	44	177										
25	10	157.1	157	96	63.7	-	-	22	15	16.6	4.6	8	30.9	14.5	6.5	64	
	20	167.1	167	106	72.2											69	
	30	177.1	177	116	82.2											74	
	40	187.1	187	126	92.2											79	
	50	197.1	197	136	102.2											84	
	80	253.1	253	192	132.2											55	112
	100	286.1	286	225	152.2											129	
	150	338.1	338	277	202.2											154	
	200	388.1	388	327	254.2	179											

Cushioning-dependent dimensions					
Size	Cushioning	L3 max.	L4 max.	≈ 1	
				For adjusting the cushioning stroke	For adjusting the end position
20	P	52.4	31.2	-	4
	P1	50.1	28.9	4	8
	Y3	55.5	34.3	-	4
25	P	51.9	30.5	-	5
	P1	49.6	28.2	5	10
	Y3	65.2	43.8	-	5

Mini slides DGSL

Technical data

FESTO

Hole pattern for mounting threads and centring holes

DGSL-20-10/20

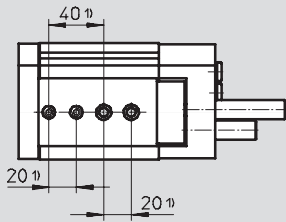

DGSL-20-30/40

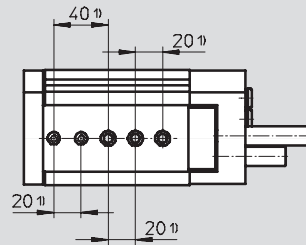

DGSL-20-50

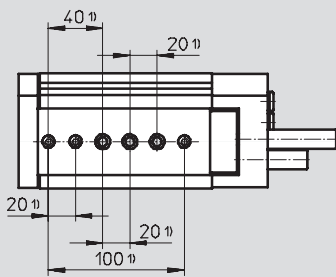

DGSL-20-80

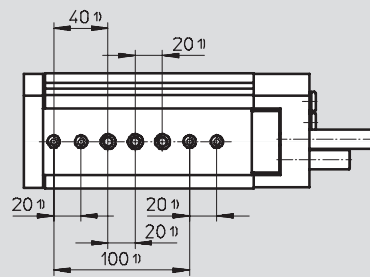

DGSL-20-100 ... 200

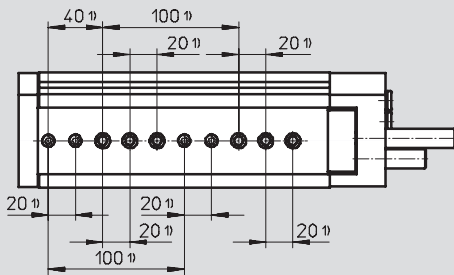

DGSL-25-10

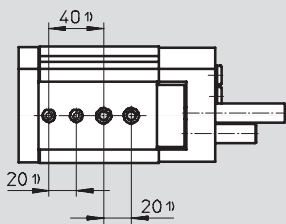

DGSL-25-20

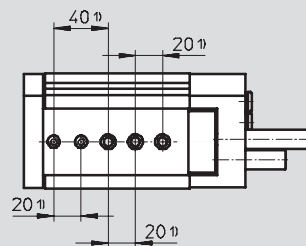

Mini slides DGSL

Technical data

Hole pattern for mounting threads and centring holes

DGSL-25-30/40

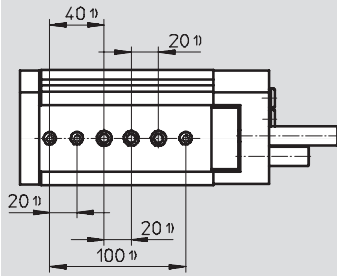

DGSL-25-50

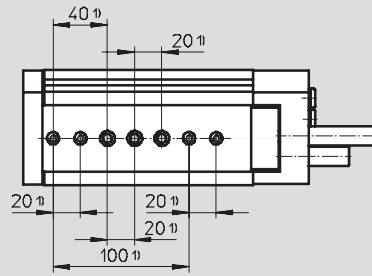

DGSL-25-80

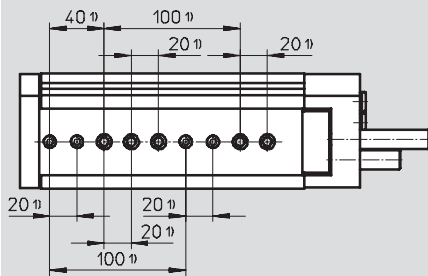

DGSL-25-100 ... 200

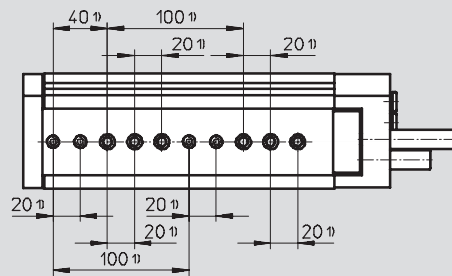

Distances from the yoke plate to the mounting threads and centring holes

DGSL-20/25

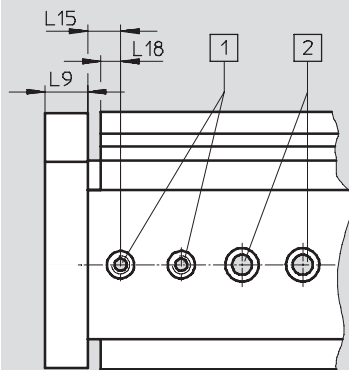

- 1 Centring holes with thread
- 2 Through-holes for mounting the drive
- 1) Tolerance for centring hole ± 0.02
- Tolerance for through-hole ± 0.1

Size	L9	L15 ± 0.05	L18
20	14	7.8	6.5
25	15	8	6.5

Mini slides DGSL-C/-E3

Technical data



Function
C – Clamping unit

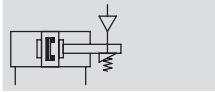

E3 – End position locking

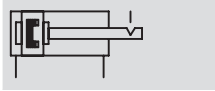

Size
6 ... 25

Wearing parts kits
→ 42



Note

Additional measures are required for use in safety-related control systems; in Europe, for example, the standards listed under the EC Machinery Directive must be observed. Without

additional measures in accordance with statutory minimum requirements, the product is not suitable for use in safety-related sections of control systems.

General technical data – Clamping unit								
Size		6	8	10	12	16	20	25
Function		– Mechanical clamping – For fixing the slide in any position – Frictional locking						
Clamping type with effective direction of action		From both sides						
		Clamping via spring force, air pressure to release						
Pneumatic connection		M5						
Mounting position		Any						
Static holding force	[N]	80	80	180	180	350	350	600
Product weight	[g]	10	10	15	15	50	50	50

Operating and environmental conditions – Clamping unit	
Operating medium	Dried compressed air, lubricated or unlubricated
Min. release pressure	[bar] 3
Max. operating pressure	[bar] ≤ 10

General technical data – End-position locking								
Size		6	8	10	12	16	20	25
Function		– Mechanical locking when the end position is reached – For fixing the slide in the unpressurised, retracted state – Positive locking						
Clamping type with effective direction of action		From both sides						
		Clamping via spring force, air pressure to unlock						
Pneumatic connection		M5						
Mounting position		Any						
Static holding force	[N]	60	60	160	160	250	380	640
Product weight	[g]	13	13	26	26	64	64	65

Operating and environmental conditions – End position locking	
Operating medium	Dried compressed air, lubricated or unlubricated
Operating pressure	[bar] 3 ... 8

Mini slides DGSL-C/-E3

Technical data



Adjustable end position range

When using end position locking (E3), the adjustable range of the rear end position is reduced by the following values.

1 Adjustable end position range

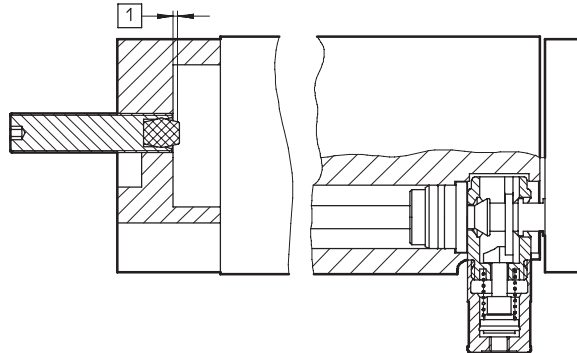

Size	1
6, 8	max. 1.5 mm
10, 12	max. 2.3 mm
16, 20, 25	max. 2.7 mm

Dimensions

Download CAD data → www.festo.com/en/engineering

C – Clamping unit / E3 – End position locking

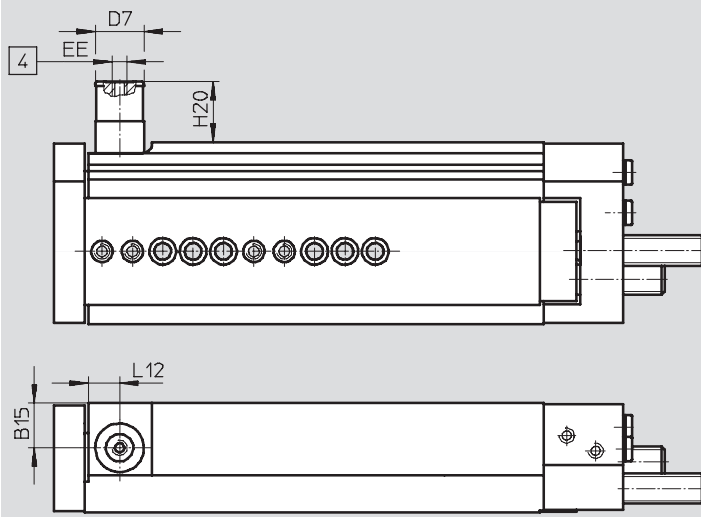

4 Compressed air connection

Size	B15	D7 Ø	EE	H20		L12
				C	E3	
6	7.2	12	M5	10.7	21.2	7.3
8	9.9	12		10.5	21	7.3
10	11.2	16		11.8	21.2	10.5
12	14.8	16		10.5	19.9	10.3
16	14	20		27.5	30.5	13
20	17	20		21.3	24.3	14
25	22.55	20		17.75	20.65	14

Mini slides DGSL

Technical data



Ordering data				Ordering data				Ordering data				
Size	Stroke [mm]	Part No.	Type	Size	Stroke [mm]	Part No.	Type	Size	Stroke [mm]	Part No.	Type	
With cushioning P				With cushioning P1				With cushioning Y3				
4	10	543 910	DGSL-4-10-PA	4	10	543 913	DGSL-4-10-P1A	4	10	-		
	20	543 911	DGSL-4-20-PA		20	543 914	DGSL-4-20-P1A		20	-		
	30	543 912	DGSL-4-30-PA		30	543 915	DGSL-4-30-P1A		30	-		
6	10	543 916	DGSL-6-10-PA	6	10	543 921	DGSL-6-10-P1A	6	10	-		
	20	543 917	DGSL-6-20-PA		20	543 922	DGSL-6-20-P1A		20	-		
	30	543 918	DGSL-6-30-PA		30	543 923	DGSL-6-30-P1A		30	-		
	40	543 919	DGSL-6-40-PA		40	543 924	DGSL-6-40-P1A		40	-		
	50	543 920	DGSL-6-50-PA		50	543 925	DGSL-6-50-P1A		50	-		
8	10	543 926	DGSL-8-10-PA	8	10	543 932	DGSL-8-10-P1A	8	10	-		
	20	543 927	DGSL-8-20-PA		20	543 933	DGSL-8-20-P1A		20	-		
	30	543 928	DGSL-8-30-PA		30	543 934	DGSL-8-30-P1A		30	543 938	DGSL-8-30-Y3A	
	40	543 929	DGSL-8-40-PA		40	543 935	DGSL-8-40-P1A		40	543 939	DGSL-8-40-Y3A	
	50	543 930	DGSL-8-50-PA		50	543 936	DGSL-8-50-P1A		50	543 940	DGSL-8-50-Y3A	
	80	543 931	DGSL-8-80-PA		80	543 937	DGSL-8-80-P1A		80	543 941	DGSL-8-80-Y3A	
10	10	543 942	DGSL-10-10-PA	10	10	543 949	DGSL-10-10-P1A	10	10	-		
	20	543 943	DGSL-10-20-PA		20	543 950	DGSL-10-20-P1A		20	-		
	30	543 944	DGSL-10-30-PA		30	543 951	DGSL-10-30-P1A		30	543 956	DGSL-10-30-Y3A	
	40	543 945	DGSL-10-40-PA		40	543 952	DGSL-10-40-P1A		40	543 957	DGSL-10-40-Y3A	
	50	543 946	DGSL-10-50-PA		50	543 953	DGSL-10-50-P1A		50	543 958	DGSL-10-50-Y3A	
	80	543 947	DGSL-10-80-PA		80	543 954	DGSL-10-80-P1A		80	543 959	DGSL-10-80-Y3A	
	100	543 948	DGSL-10-100-PA		100	543 955	DGSL-10-100-P1A		100	543 960	DGSL-10-100-Y3A	
	150	543 949	DGSL-10-150-PA		150	543 956	DGSL-10-150-P1A		150	543 961	DGSL-10-150-Y3A	
12	10	543 961	DGSL-12-10-PA	12	10	543 969	DGSL-12-10-P1A	12	10	-		
	20	543 962	DGSL-12-20-PA		20	543 970	DGSL-12-20-P1A		20	-		
	30	543 963	DGSL-12-30-PA		30	543 971	DGSL-12-30-P1A		30	543 977	DGSL-12-30-Y3A	
	40	543 964	DGSL-12-40-PA		40	543 972	DGSL-12-40-P1A		40	543 978	DGSL-12-40-Y3A	
	50	543 965	DGSL-12-50-PA		50	543 973	DGSL-12-50-P1A		50	543 979	DGSL-12-50-Y3A	
	80	543 966	DGSL-12-80-PA		80	543 974	DGSL-12-80-P1A		80	543 980	DGSL-12-80-Y3A	
	100	543 967	DGSL-12-100-PA		100	543 975	DGSL-12-100-P1A		100	543 981	DGSL-12-100-Y3A	
	150	543 968	DGSL-12-150-PA		150	543 976	DGSL-12-150-P1A		150	543 982	DGSL-12-150-Y3A	
16	10	543 983	DGSL-16-10-PA	16	10	543 991	DGSL-16-10-P1A	16	10	-		
	20	543 984	DGSL-16-20-PA		20	543 992	DGSL-16-20-P1A		20	-		
	30	543 985	DGSL-16-30-PA		30	543 993	DGSL-16-30-P1A		30	543 999	DGSL-16-30-Y3A	
	40	543 986	DGSL-16-40-PA		40	543 994	DGSL-16-40-P1A		40	544 000	DGSL-16-40-Y3A	
	50	543 987	DGSL-16-50-PA		50	543 995	DGSL-16-50-P1A		50	544 001	DGSL-16-50-Y3A	
	80	543 988	DGSL-16-80-PA		80	543 996	DGSL-16-80-P1A		80	544 002	DGSL-16-80-Y3A	
	100	543 989	DGSL-16-100-PA		100	543 997	DGSL-16-100-P1A		100	544 003	DGSL-16-100-Y3A	
	150	543 990	DGSL-16-150-PA		150	543 998	DGSL-16-150-P1A		150	544 004	DGSL-16-150-Y3A	
20	10	544 005	DGSL-20-10-PA	20	10	544 014	DGSL-20-10-P1A	20	10	-		
	20	544 006	DGSL-20-20-PA		20	544 015	DGSL-20-20-P1A		20	-		
	30	544 007	DGSL-20-30-PA		30	544 016	DGSL-20-30-P1A		30	544 023	DGSL-20-30-Y3A	
	40	544 008	DGSL-20-40-PA		40	544 017	DGSL-20-40-P1A		40	544 024	DGSL-20-40-Y3A	
	50	544 009	DGSL-20-50-PA		50	544 018	DGSL-20-50-P1A		50	544 025	DGSL-20-50-Y3A	
	80	544 010	DGSL-20-80-PA		80	544 019	DGSL-20-80-P1A		80	544 026	DGSL-20-80-Y3A	
	100	544 011	DGSL-20-100-PA		100	544 020	DGSL-20-100-P1A		100	544 027	DGSL-20-100-Y3A	
	150	544 012	DGSL-20-150-PA		150	544 021	DGSL-20-150-P1A		150	544 028	DGSL-20-150-Y3A	
200	544 013	DGSL-20-200-PA	200	544 022	DGSL-20-200-P1A	200	544 029	DGSL-20-200-Y3A				
25	10	544 030	DGSL-25-10-PA	25	10	544 039	DGSL-25-10-P1A	25	10	-		
	20	544 031	DGSL-25-20-PA		20	544 040	DGSL-25-20-P1A		20	-		
	30	544 032	DGSL-25-30-PA		30	544 041	DGSL-25-30-P1A		30	544 048	DGSL-25-30-Y3A	
	40	544 033	DGSL-25-40-PA		40	544 042	DGSL-25-40-P1A		40	544 049	DGSL-25-40-Y3A	
	50	544 034	DGSL-25-50-PA		50	544 043	DGSL-25-50-P1A		50	544 050	DGSL-25-50-Y3A	
	80	544 035	DGSL-25-80-PA		80	544 044	DGSL-25-80-P1A		80	544 051	DGSL-25-80-Y3A	
	100	544 036	DGSL-25-100-PA		100	544 045	DGSL-25-100-P1A		100	544 052	DGSL-25-100-Y3A	
	150	544 037	DGSL-25-150-PA		150	544 046	DGSL-25-150-P1A		150	544 053	DGSL-25-150-Y3A	
200	544 038	DGSL-25-200-PA	200	544 047	DGSL-25-200-P1A	200	544 054	DGSL-25-200-Y3A				

Mini slides DGSL

Ordering data – Modular products



[M] Mandatory data				[O] Options		[M]	
Module No.	Function	Size	Stroke	Clamping unit	End position locking	Cushioning	Position sensing
543 902	DGSL	4	10 ... 200	C	E3	P P1 Y3	A
543 903		6					
543 904		8					
543 905		10					
543 906		12					
543 907		16					
543 908		20					
543 909		25					
Order example							
543 904	DGSL	8	30		E3	Y3	A

Ordering table											
Size	4	6	8	10	12	16	20	25	Condi- tions	Code	Enter code
[M] Module No.	543 902	543 903	543 904	543 905	543 906	543 907	543 908	543 909			
Function	Mini slide with recirculating ball bearing guide									DGSL	DGSL
										-	-
Size	4	6	8	10	12	16	20	25		...	-
										-	-
Stroke [mm]	10									10	
	20									20	
	30									30	
	-	40								40	
	-	50								50	
	-	-	80						80		
	-	-	-	100				100			
	-	-	-	-	150			150			
	-	-	-	-	-	-	200	200			
[O] Clamping unit	Built-on									C	
End position locking	With piston rod in retracted position									[1] E3	
[M] Cushioning	Flexible cushioning rings/plates at both ends, end positions adjustable									P	
	Flexible cushioning rings/plates at both ends, end positions adjustable, with fixed stop									P1	
	-	-	Progressive shock absorber at both ends						[2] Y3		
Position sensing	Via proximity sensor									A	A

[1] E3 Not with clamping unit C

[2] Y3 Minimum stroke 30 mm

Transfer order code







	DGSL	-		-		-		-		A
--	------	---	--	---	--	---	--	---	--	---

Mini slides DGSL

Wearing parts kits and accessories



Ordering data – Wearing parts kits		
Size	Part No.	Type
4	713 743	DGSL-4-...
6	713 744	DGSL-6-...
8	713 745	DGSL-8-...
10	713 746	DGSL-10-...
12	713 747	DGSL-12-...
16	713 748	DGSL-16-...
20	713 749	DGSL-20-...
25	713 750	DGSL-25-...



Ordering data						
	For size	Brief description	Order code	Part No.	Type	PU ¹⁾
Centring sleeve ZBH Technical data → Internet: zbh						
	4, 6	For centring loads and attachments (the scope of delivery of the mini slide includes six centring sleeves)	-	189 652	ZBH-5	10
	8, 10, 12, 16			186 717	ZBH-7	
	20, 25			150 927	ZBH-9	
Connecting sleeve ZBV Technical data → Internet: zbv						
	8, 10	<ul style="list-style-type: none"> For connecting mini slide DGSL with mini slide DGSL Sizing information refers to the y axis 	-	548 802	ZBV-M4-7	3
	12, 16			548 803	ZBV-M5-7	
	20, 25			548 804	ZBV-M6-9	
Shock absorber DYEF Technical data → Internet: dyef						
	4	Flexible cushioning, with metal stop	P1	548 370	DYEF-M4-Y1F	1
	6			548 371	DYEF-M5-Y1F	
	8			548 372	DYEF-M6-Y1F	
	10			548 373	DYEF-M8-Y1F	
	12			548 374	DYEF-M10-Y1F	
	16			548 375	DYEF-M12-Y1F	
	20			548 376	DYEF-M14-Y1F	
	25			548 377	DYEF-M16-Y1F	
Shock absorber DYSW Technical data → Internet: dysw						
	8	Progressive shock absorbers, both ends	Y3	548 070	DYSW-4-6-Y1F	1
	10			548 071	DYSW-5-8-Y1F	
	12			548 072	DYSW-7-10-Y1F	
	16			548 073	DYSW-8-14-Y1F	
	20			548 074	DYSW-10-17-Y1F	
	25			548 075	DYSW-12-20-Y1F	
One-way flow control valve GRLA Technical data → Internet: grla						
	4, 6, 8	<ul style="list-style-type: none"> For speed regulation Only one GRLA-M3-QS-3 can be mounted onto the front of size 4 slides 	-	175 041	GRLA-M3-QS-3	1
	10, 12, 16			175 038	GRLA-M3	
	20, 25			193 138	GRLA-M5-QS-4-D	
				193 144	GRLA-G ¹ / ₈ -QS-6-D	
Push-in fitting QSM Technical data → Internet: qsm						
	4, 6, 8	For connecting compressed air tubing with standard external diameters	-	153 301	QSM-M3-3	10
	10, 12, 16			153 304	QSM-M5-4	
	20, 25			153 307	QSM-1/8-6	



1) Packaging unit quantity

Mini slides DGSL



Accessories

FESTO

Technical data → Internet: sm						
	Type of mounting	Switch output	Electrical connection, connection direction	Cable length [m]	Part No.	Type
N/O contact						
	Insertable in the slot from above, flush with cylinder profile	PNP	Cable, 3-wire, in-line	2.5	525 915	SMT-10F-PS-24V-K2,5L-OE
			Plug M8x1, 3-pin, in-line	0.3	525 916	SMT-10F-PS-24V-K0,3L-M8D
			Plug M8x1, 3-pin, lateral	0.3	526 675	SMT-10F-PS-24V-K0,3Q-M8D
	Insertable in the slot lengthwise	PNP	Plug M8x1, 3-pin, in-line	0.3	173 220	SMT-10-PS-SL-LED-24
			Cable, 3-wire, in-line	2.5	173 218	SMT-10-PS-KL-LED-24

Technical data → Internet: sm						
	Type of mounting	Switch output	Electrical connection, connection direction	Cable length [m]	Part No.	Type
N/O contact						
	Insertable in the slot from above, flush with cylinder profile	Contacting	Plug M8x1, 3-pin, in-line	0.3	525 914	SME-10F-DS-24V-K0,3L-M8D
			Cable, 3-wire, in-line	2.5	525 913	SME-10F-DS-24V-K2,5L-OE
			Cable, 2-wire, in-line	2.5	526 672	SME-10F-ZS-24V-K2,5L-OE
	Insertable in the slot lengthwise	Contacting	Plug M8x1, 3-pin, in-line	0.3	173 212	SME-10-SL-LED-24
			Cable, 3-wire, in-line	2.5	173 210	SME-10-KL-LED-24

 Note
Proximity sensors SME are not permitted for size 4.

Ordering data – Connecting cables						
Technical data → Internet: nebu						
	Electrical connection, left	Electrical connection, right	Cable length [m]	Part No.	Type	
	Straight socket, M8x1, 3-pin	Cable, open end, 3-wire	2.5	541 333	NEBU-M8G3-K-2.5-LE3	
			5	541 334	NEBU-M8G3-K-5-LE3	
	Angled socket, M8x1, 3-pin	Cable, open end, 3-wire	2.5	541 338	NEBU-M8W3-K-2.5-LE3	
			5	541 341	NEBU-M8W3-K-5-LE3	

Products and services – everything from a single source

Products incorporating new ideas are created when enthusiasm for technology and efficiency come together. Tailor-made service goes without saying when the customer is the focus of attention.

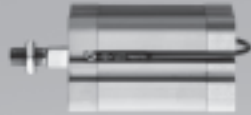

Pneumatic and electrical drives

- Pneumatic cylinders
- Semi-rotary drives
- Handling modules
- Servopneumatic positioning systems
- Electromechanical drives
- Positioning controllers and controllers



Valves and valve terminals

- Standard valves
- Universal and application-optimised valves
- Manually and mechanically actuated valves
- Shut-off, pressure control and flow control valves
- Proportional valves
- Safety valves

Fieldbus systems/ electrical peripherals

- Fieldbus Direct
- Installation system CP/CPI
- Modular electrical terminal CPX



Compressed air preparation

- Service unit combinations
- Filter regulators
- Filters
- Pressure regulators
- Lubricators
- On-off and soft-start valves
- Dryers
- Pressure amplifiers
- Accessories for compressed air preparation

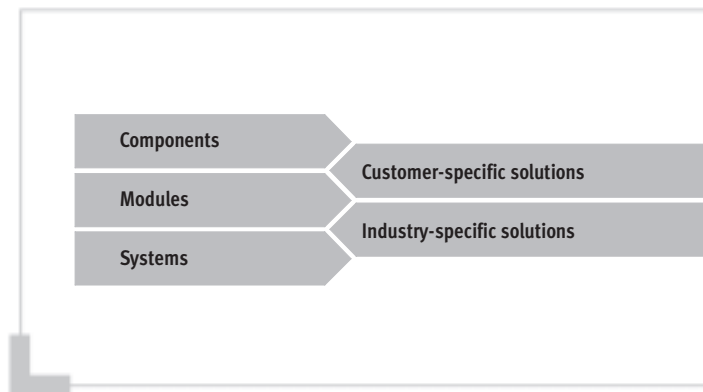

Services from Festo to increase your productivity – across the entire value creation sequence



Engineering – for greater speed in the development process

- CAD models
- 14 engineering tools
- Digital catalogue
- FluidDRAW®
- More than 1,000 technical consultants and project engineers worldwide
- Technical hotlines



Supply chain – for greater speed in the procurement process

- E-commerce and online shop
- Online order tracking
- Euro special manufacturing service
- Logistics optimisation



Gripping and vacuum technology

- Vacuum generators
- Vacuum grippers
- Vacuum security valves
- Vacuum accessories
- Standard grippers
- Micro grippers
- Precision grippers
- Heavy-duty grippers



Sensors and monitoring units

- Proximity sensors
- Pressure and flow sensors
- Display and operating units
- Inductive and optical proximity sensors
- Displacement encoders for positioning cylinders
- Optical orientation detection and quality inspection



Controllers/bus systems

- Pneumatic and electropneumatic controllers
- Programmable logic controllers
- Fieldbus systems and accessories
- Timers/counters
- Software for visualisation and data acquisition
- Display and operating units



Accessories

- Pipes
- Tubing
- Pipe connectors and fittings
- Electrical connection technology
- Silencers
- Reservoirs
- Air guns

All in all, 100% product and service quality

A customer-oriented range with unlimited flexibility: Components combine to produce ready-to-install modules and systems. Included in this are special designs – since at Festo, most industry-specific products and customer-specific solutions are based on the 23,000 plus catalogue products. Combined with the services for the entire value creation sequence, the end result is unbeatable economy.



Assembly – for greater speed in the assembly/commissioning process

- Prepack
- Preassembly
- Turnkey pneumatics
- Handling solutions



Operation – for greater speed in the operational process

- Spare parts service
- Energy saving service
- Compressed air consumption analysis
- Compressed air quality analysis
- Customer service

What must be observed when using Festo components?

Specified limit values for technical data and any specific instructions must be adhered to by the user in order to ensure recommended operating conditions.

When pneumatic components are used, the user shall ensure that they are operated using correctly prepared compressed air without aggressive media.

When Festo components are used in safety-oriented applications, the user shall ensure that all applicable

national and local safety laws and regulations, for example the machine directive, together with the relevant references to standards are observed. Unauthorised conversions or modifications to products and systems from Festo involve a safety risk and are thus not permissible.

Festo does not accept any liability for resulting damages.

You should contact Festo's advisors if one of the following apply to your application:

- The ambient conditions and conditions of use or the operating medium differ from the specified technical data.
- The product is to perform a safety function.
- A risk or safety analysis is required.
- You are unsure about the product's suitability for use in the planned application.
- You are unsure about the product's suitability for use in safety-oriented applications.

All technical data applies at the time of going to print.

All texts, representations, illustrations and drawings included in this catalogue are the intellectual property of Festo AG & Co. KG, and are protected by copyright law.

All rights reserved, including translation rights. No part of this publication may be reproduced or transmitted in any form or by any means, electronic, mechanical, photocopying or otherwise, without the prior written permission of Festo AG & Co. KG. All technical data subject to change according to technical update.