

Електролукс Electrolux Bitola

KOMPLETEN KATALOG NA ELEKTRICNI GREALKI I KALORIFERI-TAJFUNI

Electric Heating Equipment

Model	Description	Page No.
UNIT HEATERS		
EGH	Heavy Duty Forced Air Unit Heaters, 15 - 50 kW	2
EGE	Forced Air Unit Heaters, 2 - 40 kW	4
EXU	Explosion Proof Forced Air Unit Heaters, 3 - 30 kW	6
CONVECTION HEATERS		
ECV	Heavy Duty Convection Heater, 2 - 3 kW	10
DUCT HEATERS		
EDDF	Flanged Air Duct Heater, 2.5 - 62.5 kW	11
EDIF	Insert Air Duct Heater, 2.5 - 62.5 kW	11
INFRARED HEATERS		
General Information		15
ERI Series	Process Heating Radiant Heaters, 1 - 10 kW	17
ERIC	with a Singular Tubular Element	17
ERIE	with Double Tubular Heating Elements	17
ERIR	with Hairpin Tubular Heating Element and Moisture Resistant Housing	17
ERIQT	with Quartz Tube Heating Element	18
ERIQF	with Double Quartz Heating Elements	18
ERIQL	with Quartz Lamp Heating Element	18
ERIH	Heavy Duty Infrared Heater with Double Tubular Heating Elements	18
ER	Series Comfort Heating Radiant Heaters, 1 - 6.2 kW	19
ERC	with Single Tubular Heating Element	19
ERE	with Double Tubular Heating Elements	19
ERQT	with Quartz Tube Heating Element	19
ERQL	with Quartz Lamp Heating Element	20
ERH	Series Heavy Duty Comfort Heating Radiant Heaters, 1 - 6.5 kW	20
ERHC	with Single Tubular Heating Element	20
ERHR	with Hairpin Tubular Heating Element and Moisture Resistant Housing	20
ERHQT	with Quartz Tube Heating Element	20
TECHNICAL DATA		
Electrical Circuits		21
Hazardous Locations Descriptions, Atmospheric Conditions and Temperature Codes		22
OTHER ELECTRICAL HEATING EQUIPMENT*		
EPH	Control Panel and Pump House Heater	23
EXCA/EXC	Explosion Resistant Convection Heaters	23
EPW Series	Packaged Circulation Water Heaters	23
EYSB	Packaged Steam Boilers	23
WARRANTY		
Limited Product Warranty		24

SODRZINA NA KATALOGOT



Електродукс Electrolux Bitola

Technical Data Hazardous Locations

ATMOSPHERIC CONDITIONS AND TEMPERATURE CODES

The information listed on this page is to be used only as a general guide. Consult the latest edition of the Code to check the suitability of the heater to your needs.

For detailed information concerning the installation of electrical equipment in hazardous locations, refer to either the Canadian Electrical Code Part 1 Section 18, available from the Canadian Standards Association, or the National Electrical Code Chapter 5 Articles 500 through 503, available from the National Fire Protection Association.

Where electrical equipment is required by Section 18 or Chapter 5 to be approved for the class of location, it shall also be approved for the specific gas, vapor, or dust that will be present. Such approval may be indicated by one or more atmospheric group designations which have been established for the purpose of testing and approval.

Note that the maximum external temperature of the equipment shall not exceed the minimum ignition temperature of the atmosphere as listed in Table 2.

Table 1 - Equipment Maximum Temperature

Temperature Code	Maximum External Temperature
T1	430°C / 802°F
T2	300°C / 572°F
T2A	280°C / 536°F
T2B	260°C / 500°F
T2C	230°C / 446°F
T2D	215°C / 411°F
T3	200°C / 392°F
T3A	180°C / 336°F
T3B	165°C / 320°F
T3C	160°C / 320°F
T4	135°C / 275°F
T4A	120°C / 248°F
T5	100°C / 212°F
T6	85°C / 185°F

Table 2 - Atmospheric Conditions

ATMOSPHERE	MIN. IGNITION TEMP. LIMIT
GROUP A CONTAINING	
acetylene	305°C / 581°F
GROUP B CONTAINING	
butadiene	420°C / 788°F
ethylene oxide	420°C / 788°F
hydrogen	500°C / 932°F
manufactured gases containing more than 30% hydrogen (by volume)	500°C / 932°F
propylene oxide	405°C / 760°F
GROUP C CONTAINING	
acetaldehyde	175°C / 347°F
cyclopropane	498°C / 928°F
diethyl ether	160°C / 320°F
ethylene	450°C / 842°F
unsymmetrical dimethyl hydrazine (UDMH 1, 1-dimethyl hydrazine)	240°C / 460°F
GROUP D CONTAINING	
acetone	465°C / 869°F
acrylonitrile	481°C / 898°F
alcohol (see ethyl alcohol)	
ammonia	651°C / 1204°F
benzene	498°C / 928°F
benzene (see petroleum naphtha)	
benzol (see benzene)	
butane	287°C / 549°F
1-butanol (butyl alcohol)	318°C / 603°F
2-butanol (secondary butyl alcohol)	405°C / 761°F
butyl acetate	425°C / 797°F
isobutyl acetate	421°C / 790°F
ethane	473°C / 883°F
ethyl alcohol	363°C / 683°F
ethyl acetate	426°C / 799°F
ethylene dichloride	415°C / 779°F
acetylene	380°C / 716°F
hexane	204°C / 389°F
heptane	233°C / 451°F
isopentane	105°C / 240°F
methane	535°C / 1005°F
methanol (methyl alcohol)	383°C / 721°F
2-methyl-1-butanol (isomethyl alcohol)	350°C / 662°F
methyl ethyl ketone	404°C / 759°F
methyl isobutyl ketone	448°C / 838°F
2-methyl-1-propanol (isobutyl alcohol)	415°C / 779°F
2-methyl-2-propanol (tertiary butyl alcohol)	478°C / 892°F
naphtha (see petroleum naphtha)	
normal gas	482°C / 900°F
octane	206°C / 403°F
pentane	260°C / 500°F
1-pentanol (amyl alcohol)	300°C / 572°F
petroleum naphtha	288°C / 550°F
propane	432°C / 810°F
1-propanol (propyl alcohol)	412°C / 774°F
2-propanol (isopropyl alcohol)	308°C / 580°F
propylene	455°C / 851°F
isoprene	490°C / 914°F
toluene	480°C / 896°F
vinyl acetate	402°C / 756°F
vinyl chloride	472°C / 882°F
xylene	463°C / 865°F

Ovaj crtež e sopstvenost na Electrolux-Bitola. Bez negovo pismeno odobruvanje istiot nesmee da se prepisiva, umnozava niti kopira bez soglasnost od Electroluks vo sprotivno se snosat posledici vo smislana clenovite 163 i 164 od Kriviciot zakon R.M. (povreda na avtorsko pravo)

Electroluks is registered trademark of Elektroluks companies in Macedonia and other countries



Електролукс Electrolux Bitola

Ovoј crtez e sopstvenost na Electrolux-Bitola.Bez negovo pismeno odobruvanje istot nesmee da se prepisiva ,umozuva niti kopira bez soglasnost od Elctroluks vo sproftivo se snosat posledici vo smislana clenovite 163 i 164 od kriticniot zakon R.Mi (povreda na avtorsko pravo)



APPLICATION

The Reznor EGH heater has been designed specifically for heavy duty use in industrial environments. This heater will reduce the downtime and maintenance costs experienced with heaters of standard design.

STANDARD EGH PRODUCT FEATURES

- approved for horizontal and vertical air flow
- automatic reset high limit
- 15, 20, 25, 30, 40, 50 kw units
- 40 and 50 kw units incorporate split loads (50%) for remotely controlled energy management systems
- factory installed transformers, contactors, and thermostats where specified
- individually adjustable louvres
- factory balanced aluminum fan blade
- fan delay in "ON" and "OFF" cycles
- full sized control panel with hinged removable door, constructed to NEMA 12 standards
- "Fan Only" terminals for connection to remote switch
- 14 Gauge steel cabinet
- epoxy painted (ASA 61 Grey) for superior resistance to corrosion
- 1/3 Hp motor with sealed ball bearings and totally enclosed construction
- motor mounted outside of the element bundle eliminating premature failure due to overheating and providing easy access for motor maintenance
- elements are robust finned tubular sheathed type with epoxy sealed terminals to eliminate contamination from moisture and airborne impurities

Page 1

Model EGH

Heavy Duty, Electric, Forced-Air, Unit Heater,

APPLICATIONS

Reznor Model EGH is designed for use in commercial or industrial heating applications. Typical applications include:

- mine shafts
- pulp and paper mills
- hoist houses
- welding shops
- maintenance shops
- sewage treatment plants
- chemical plants
- repair shops
- wash down areas
- weigh scale pits
- elevator shafts
- high humidity areas
- crane cabs

MOUNTING CONFIGURATIONS

FIGURE 1 - HORIZONTAL AIR FLOW WALL MOUNT

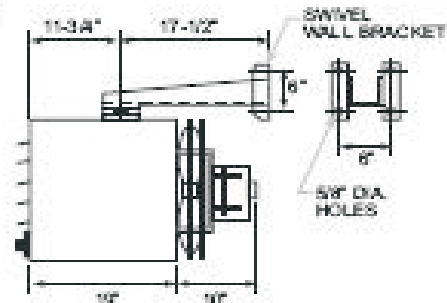

FIGURE 2 - HORIZONTAL AIR FLOW CEILING MOUNT

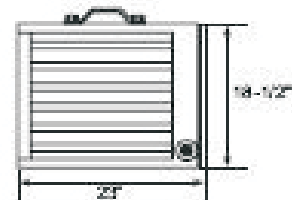
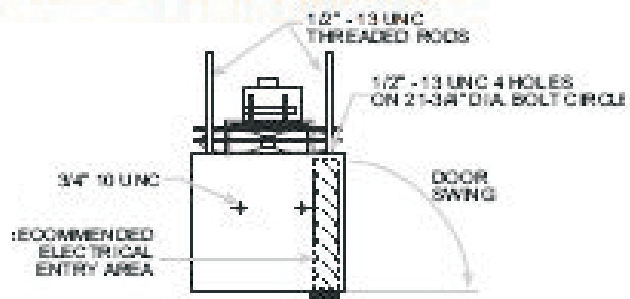

FIGURE 3 - VERTICAL AIR FLOW



Браќа Минџови бр.18, Стара Царица Битола. Г.Т.Ц.Бунјаковец Скопје
Тел/Факс: 047/203-900; 203-330; 070/237-108
Тел/Факс: 02/329 8 130; 070/237 198

www.elektroluks.com.mk, www.electrolux.com.mk, electrolux@mt.net.mk

Electroluks is registered trademark of Elektroluks companies in Macedonia and other countries



Електролукс Electrolux Bitola

Ovoј crtez e сопственост на ElectroLux-Bitola. Bez negovo писмено одобрување истиот несмеа да се препишува, умножува ниш копира без согласност од ElectroLux во спротивно се сносат последици во смисланиа членовите 163 и 164 од кривичниот закон R.M. (повреда на авторско право)

SPECIFICATIONS Model EGH

SIZE	kW (BTU/H)	VOLTS	PHASE	CFM	TEMP RISE		NET WEIGHT	
					°F	°C	LIB	KG
15	15 (51180)	208	3	1800	25	(14)	105	(47.6)
		240						
		480						
		600						
20	20 (68240)	208	3	1800	34	(19)	105	(47.6)
		240						
		480						
		600						
25	25 (83100)	208	3	1800	41	(24)	105	(47.6)
		240						
		480						
		600						
30	30 (102300)	480	3	2100	41	(24)	105	(47.6)
		600						
		600						
40	30 (136480)	480	3	2100	58	(32)	125	(56.7)
		600						
50	50 (170600)	480	3	2100	72	(40)	125	(56.7)

NOTES

1. Motor voltage and phase is same as heater supply.
2. Standard control voltage is 240V. A control transformer is included where required. Other control voltages are available (check factory).
3. 15, 20, 25, 30 kw units are pre-wired as one circuit. The split load feature (50%) is available as an option.
4. 40 and 50 kw units are pre-wired for split load (50%) control by customer unless specified otherwise.
5. All motors are 1/3 hp, totally enclosed ball bearing type, permanently lubricated, thermally protected.

OPTIONAL FACTORY INSTALLED FEATURES

- built-in thermostat 41°F to 100°F (5°C to 38°C)
- disconnect switch with door interlock
- HRC main load fuses
- fused control circuit
- manual reset high limit
- "Fan Only" switch
- low voltage relay for remote 24V thermostat
- epoxy painted fan blade and motor
- special wattages and voltages
- special control voltages (standard is 240V)
- available in special finishes
- split load feature - 15, 20, 25, 30 kw units
- nickel plated elements
- alloy elements with brazed alloy fins
- NEMA 4 construction - epoxy & sealed elements
- stainless steel cabinet



ACCESSORIES FOR FIELD INSTALLATION

- Thermostat kit 41°F to 100°F (5°C to 38°C)
- Wall mount bracket (horizontal air flow)
- air diffuser (vertical air flow)
- "Fan Only" switch and cover plate
- line voltage and low voltage thermostats

TO ORDER SPECIFY:

Model number, voltage, phase, kilowatts, optional features, and accessories.



Електролуks Electrolux Bitola

Ovoј crtez e сопственост на Electrolux-Bitola. Bez negovo писмено одобрување истиот несмеа да се препишува, умножува нити копира без согласност од Electroluks во спротивно се сносат последици во смисла на членовите 163 и 164 од Кривичниот закон Р.М. (повреда на авторско право)

TABLE 3 - SPECIFICATIONS Model EGE

SIZE	KW (BTU/H)	VOLTS	PHASE	CFM	TEMP RISE		MOTOR VOLTS
					°F	°C	
2	2 (6824)	208	1 or 3	460	14	(8)	208/240
		240	1 or 3				
		347	1				
3	3 (10216)	208	1 or 3	460	21	(12)	208/240
		240	1 or 3				
		347	1				
4	4 (13648)	208	1 or 3	475	28	(16)	208/240
		240	1 or 3				
		347	1				
		480	1 or 3				
		600	1 or 3				
5	5 (17060)	208	1 or 3	480	40	(22)	208/240
		240	1 or 3				
		347	1				
		600	1 or 3				
7	7.5 (25560)	208	3	590	43	(24)	208/240
		240	3				
		480	1 or 3				
		600	1 or 3				
10	10 (34120)	208	3	760	45	(25)	208/240
		240	3				
		480	1 or 3				
		600	1 or 3				
15	15 (51180)	240	3	1040	50	(28)	240
		480	1 or 3				480
		600	1 or 3				600
20	20 (68240)	480	1 or 3	1260	55	(31)	480
		600					600
25	25 (85300)	480	3	1500	61	(34)	480
		600					600
30	30 (102360)	480	3	1500	70	(39)	480
		600					600
40	40 (136480)	480	3	1500	80	(44)	480
		600					600

OPTIONAL FACTORY INSTALLED FEATURES

- built-in thermostat 41°F to 100°F (5°C to 38°C)
- fused control circuit
- manual reset high limit
- "Fan Only" switch
- low voltage relay for remote 24V thermostat
- epoxy painted fan blade and motor
- special wattages and voltages
- special control voltages (standard is 240V)
- available in special finishes

ACCESSORIES FOR FIELD INSTALLATION

- Thermostat kit 41°F to 100°F (5°C to 38°C)
- Wall mount bracket
- line voltage and low voltage thermostats

TO ORDER SPECIFY:

Model number, voltage, phase, kilowatts, optional features, and accessories.



Електролукс Electrolux Bitola

Ovoј crtez e сопственост на Electrolux-Bitola. Bez negovo писмено одобрување истиот несмее да се препишува, умножува нити копира без согласност од Electroluks во спротивно се сносат последици во смисланиа членовите 163 и 164 од кривичниот закон R.M. (повреда на авторско право)

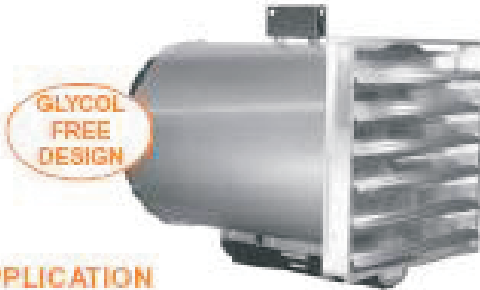

APPLICATION

The Resnor Super x-Max® unit heater is designed specifically for heating industrial spaces where potentially explosive substances are or may be present. Efficient design allows for a high temperature rise through the unit while maintaining surface temperatures suitable for T2D or T3B environments.

The EXU is intended for use in hazardous environments such as mines, water or sewage treatment plants, oil refineries, compressor stations, pulp & paper mills, paint storage rooms and cement plants.

GLYCOL FREE DESIGN

The Super x-Max® unit heater utilizes proven heat sink technology in a compact package. The heater does not contain glycol, freeing the user from the need to recharge or replace messy fluids.

If desired, the EXU can be tilted at a 30° angle below the horizontal. This mounting capability, coupled with the individually adjustable louvers, provide the maximum capability for air flow direction. Additionally, the entire louver assembly can be conveniently rotated 90°, giving the user even more air flow options.

STANDARD PRODUCT FEATURES

- units suitable for Class I, Groups C & D and Class II, Groups F & G, Divisions 1 & 2 (Group E available on special order). Also approved to IEC zone system
- ratings from 3.75 kW to 30 kW
- 208 V to 600 V, 1 or 3 phase
- high surface area extruded aluminum heat emitter with integral tubular heating elements eliminates the need for filling and recharging with glycol
- glycol free design allows the heater to be tilted at 30° below the horizontal
- proprietary x-Max® housing with track and trolley system simplifies installation and servicing
- heavy duty 16 ga. stainless steel cabinet
- 1/2 hp explosion-proof motor
- terminals for remote thermostat connection
- fan delay in ON and OFF cycles
- dual automatic reset high limits
- louvered outlet provides maximum range for outlet flow direction (air can be directed almost vertically)
- contactors are derated for extended service life

Page 6

Model EXU

Electric, Forced-Air, Unit Heater, Explosion Resistant

OPTIONAL FEATURES

- fan-only switch
- pilot light
- on-off switch
- built-in, externally adjustable thermostat
- one automatic and one manual reset high limit
- moisture resistant construction

CONSTRUCTION AND INSTALLATION

The Super x-Max® explosion resistant unit heater utilizes a unique copper free aluminum extruded convector and x-Max® terminal housing. Large convector surface area and high mass fins ensure safe and efficient low temperature heat transfer from the heating elements to the environment.

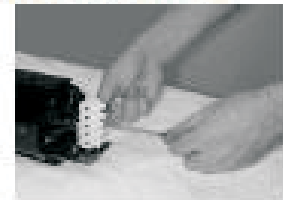

To facilitate installation, the x-Max® housing can be equipped with multiple tapped conduit entries throughout its length. A track and trolley system allows easy access to internal components.

Note: Refer to installation instructions prior to selecting fusing type and size.

THERMOSTATS

Resnor offers a wide variety of explosion resistant thermostats to suit most every need.

Super x-Max® heaters are available with optional built-in externally adjustable bulb type thermostats which are field convertible to tamper-proof.

Thermostats for remote mounting can also be provided on request.

MOTORS

- approved for Class I, Group C & D ; Class II, Groups F & G (Group E available on special order)
- fan cooled with built-in thermal overload
- double shielded ball bearings
- 1800 rpm
- 1/2 hp



Браќа Минѓови бр.18, Стара Царница Битола. Г.Т.Ц.Бунјаковец Скопје
Тел/Факс: 047/203-900; 203-330; 070/237-108
Тел/Факс: 02/329 8 130; 070/237 198

www.elektroluks.com.mk, www.electrolux.com.mk, electrolux@mt.net.mk

Electroluks is registered trademark of Elektroluks companies in Macedonia and other countries



Електролукс Electrolux Bitola

The Super x-Max® unit heater is available in ratings from 3.75 kW to 30 kW. One compact cabinet size houses all standard Super x-Max® heaters. Inlet wire guard and outlet louvre assembly are supplied with all units. Control circuit voltage is 120V. Motor voltage and phase are the same as heater voltage and phase.

Model EXU can be mounted from the ceiling, wall, from a mounted post or on a free standing floor stand. See sketches of the mounting accessories on the following pages.

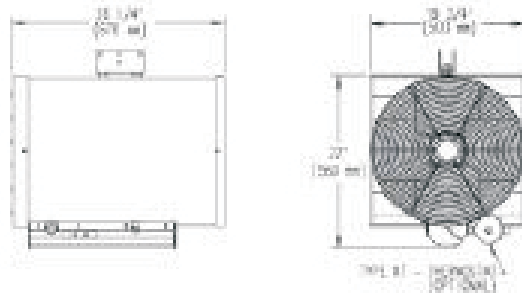

Ovoј crtez e сопственост на Electrolux-Bitola. Bez negovo писмено одобрување истиот несмеа да се препишува, умножува нити копира без согласност од Electroluks во спротивно се сносат последици во смисланиа членовите 163 и 164 од кривичниот закон R.M. (повреда на авторско право)

SIZE	kW (BTU/H)	VOLTAGE	PHASE		APPROX CFM (LITERS/SEC)	APPROX TEMPERATURE		TEMP CODE		ATMOSPHERE CONDITIONS		APPROX. WEIGHT (LBS) (KG)
			1ø	3ø		°F	°C	T20	T30	CL I, GRP C & D	CL II, GRP E & G	
3	3.75 (12795)	208	✓	✓	2800 (1320)	4	(2.2)	✓	✓	✓	✓	135 (70)
		240	✓	✓				✓	✓			
		480	--	✓				✓	✓	✓		
		600	--	✓				✓	✓	✓		
5	5 (17060)	208	✓	✓	2800 (1320)	5	(3.0)	✓	✓	✓	✓	135 (70)
		240	✓	✓				✓	✓			
		480	--	✓				✓	✓	✓		
		600	--	✓				✓	✓	✓		
7	7.5 (25390)	208	✓	✓	2800 (1320)	8	(4.5)	✓	✓	✓	✓	135 (70)
		240	✓	✓				✓	✓			
		480	--	✓				✓	✓	✓		
		600	--	✓				✓	✓	✓		
10	10 (34120)	208	--	✓	2800 (1320)	11	(6.0)	✓	✓	✓	✓	135 (70)
		240	✓	✓				✓	✓			
		480	--	✓				✓	✓	✓		
		600	--	✓				✓	✓	✓		
15	15 (51180)	208	--	✓	2500 (1180)	18	(10.0)	✓	✓	✓	✓	180 (82)
		240	--	✓				✓	✓	✓		
		480	--	✓				✓	✓	✓		
		600	--	✓				✓	✓	✓		
20 L	20 (68240)	480	--	✓	2200 (1040)	27	15.0	✓	✓	✓	✓	205 (93)
		600	--	✓				✓	✓	✓		
20 H	20 (68240)	480	--	✓	2500 (1180)	24	(13.3)	✓	--	✓	✓	180 (82)
		600	--	✓				✓	--	✓	✓	
22 L	22.5 (76770)	480	--	✓	2200 (1040)	31	(17.0)	✓	✓	✓	✓	205 (93)
		600	--	✓				✓	✓	✓		
22 H	22.5 (76770)	480	--	✓	2500 (1180)	27	15.0	✓	--	✓	✓	180 (82)
		600	--	✓				✓	--	✓	✓	
25	25 (85300)	480	--	✓	2200 (1040)	34	(18.0)	✓	--	✓	✓	205 (93)
		600	--	✓				✓	--	✓	✓	
30	30 (102360)	480	--	✓	2200 (1040)	41	(22.7)	✓	--	✓	✓	205 (93)
		600	--	✓				✓	--	✓	✓	

NOTE:

- (1) Built-in externally adjustable thermostat is optional.
- (2) Remote thermostat can be ordered separately.
- (3) Outlet wire guard is available in place of louvre assembly.
- (4) Mounting accessories must be ordered separately.

TO ORDER SPECIFY:

Quantity, model number, volts, phase, kilowatts, area classification, temperature code option, optional equipment and other special features, intended use.

MOUNTING ACCESSORIES

Type	Option Number
Ceiling Mount Kit	CK4
Wall Mount Kit	CK5
Post-mount Kit	CK20
Floor stand Kit	CK21



Електролукс Electrolux Bitola

Ovoј crtez e sopstvenost na Electrolux-Bitola.Bez negovo pismeno odobruvanje istot nesmee da se prepisiva ,umozuiva niti kopira bez soglasnost od Elctroluks vo sprofitno se snosat posledici vo smislana clenovite 163 i 164 od kriticniot zakon R.M. (повреда на авторско право)

Model EXU Electric, Forced-Air, Unit Heater, Explosion Resistant (cont'd)

Super x-Max® ACCESSORIES

Super x-Max® unit heaters readily adapt to most mounting requirements. Each heater is equipped with a basic swivel bracket that is compatible with any of the standard mounting kits.

Standard mounting brackets allow the unit to be held from a wall, ceiling, 3" pipe, or floor stand. Each mounting configuration provides maximum flexibility for outlet flow direction. The swivel bracket (standard on all heaters) features holes for affixing a safety chain. Units are shipped on a skid which can be used to lift the unit up to the desired mounting location.

In structures with very high ceilings, competitors' units may not have the range of motion needed to direct air flow to the floor. In these situations, the glycol free design of the Super x-Max® allows the unit to be mounted at 30° to the horizontal. An additional 40° downward flow can be realized with outlet louvre adjustment.



FIGURE 1 - Ceiling
Mounting Kit, Option CK4

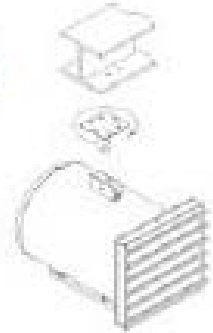

FIGURE 2 - Wall Mounting
Kit, Option CK5

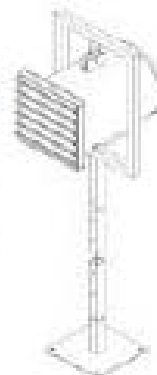

FIGURE 3 - Post Mount Kit,
Option CK20



FIGURE 4 - Floor Stand Kit,
Option CK21

Adjustable overall height from 72" to 120" (1800mm to 3050mm)
Must be lagged to a stable floor or platform.





Електролукс Electrolux Bitola

Model EXU

Electric, Forced-Air, Unit Heater, Explosion Resistant (cont'd)

STANDARD FEATURES:

- (1) 1/2 hp explosion-proof motor
- (2) inlet wire guard
- (3) tubular heating elements
- (4) extruded aluminum convector
- (5) proprietary *x-Max*® explosion resistant terminal housing
- (6) 120 V control circuit includes:
 - terminals for remote thermostat connection
 - fan delay in ON and OFF cycles
 - dual automatic reset high limits
- (7) heavy duty 16 ga. stainless steel casing
- (8) outlet louver assembly with adjustable louvers
- (9) swivel bracket

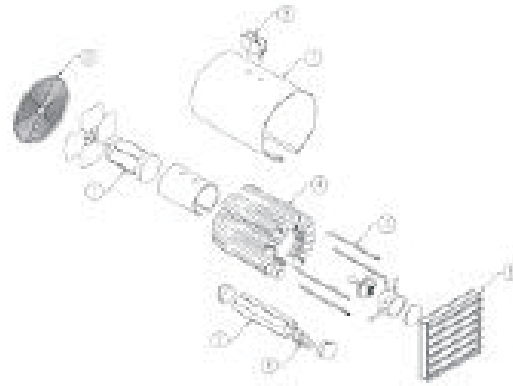

FIGURE 5 - Super *x-Max*®
Unit Heater Components

Super *x-Max*® EXPLOSION RESISTANT UNIT HEATER SAMPLE SPECIFICATION

- 1.0 Electric unit heaters shall be *Swagor x-Max*® Series, Model EXU, CSA (CUL) certified with built-in controls as indicated.
- 2.0 The heater shall be suitable for installation in
 - Class I, Group C & D (Temp. Code T2D), or,
 - Class I, Group C & D; Class II, Groups F & G (Temp Code T3B)
- 3.0 The heater shall be rated at _____ V, _____ phase, _____ kW.
- 4.0 The heater shall not contain glycol or any other heat transfer fluid.
- 5.0 The heating elements shall be metal sheathed type, completely enclosed within a copper-free aluminum extruded convector.
- 6.0 The motor shall have the same approval ratings as the heater. The motor shall be 1/2 hp, 1800 rpm, fan cooled with built-in thermal overload and double-shielded ball bearings. Three phase motors are required for three phase supply voltages.
- 7.0 The heater cabinet shall be 16 gauge stainless steel.
- 8.0 The terminal enclosure shall be extruded aluminum *x-Max*® housing with track and trolley system to facilitate wiring.
- 9.0 The following accessories and controls are to be built-in and factory pre-wired in the terminal enclosure:
 - dual automatic reset high limit protection
 - contactor (transformer included when necessary)
 - fan delay in ON and OFF cycles
 - terminals for remote thermostat connection
- 10.0 Built-in externally adjustable thermostat 'O' shall / 'O' shall not be included, or,
 Remote thermostat (if required) shall be suitable for operation with an inductive contactor coil load.
- 11.0 The heater shall be suitable for horizontal mounting or for tilting at 30° below the horizontal.
- 12.0 Mounting hardware supplied with the unit shall be suitable for:
 - Ceiling Mounting
 - Wall Mounting
 - Post Mounting
 - Floor Stand Mounting



Електролукс Electrolux Bitola

Ovoј crtez e сопственост на Electrolux-Bitola. Bez negovo pismeno одобруvanje istiот nesmee da se prepisiva, umnozuvati niti kopirati bez soglasnost od Electroluks vo sprofitno se snosati posledici vo smislana clenovite 163 i 164 od Krivichniот zakon R.M. (повreda na avtorsko pravo)

Heavy Duty Electric Convection Heaters

HEAVY DUTY ECV CONVECTION HEATER MODEL ECV

APPLICATION

Reznor ECV type convection heaters are ideally suited for industrial applications where a rugged and dependable unit is required. Typical installations include:

- factory offices
- crane cabs
- ticket booths
- guard houses
- repair shops
- shipping rooms
- trains and streetcars

The unit is not for use in hazardous locations. Please check with your Reznor Representative if you require heaters approved for hazardous areas

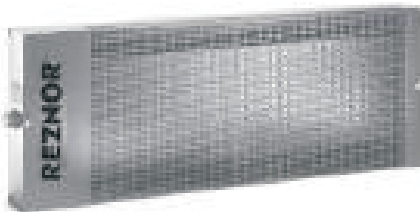

CONSTRUCTION

Model ECV heater features low density stainless steel sheathed heating elements for extended life.

The perforated enclosure is 14 gauge steel to withstand even the most hostile industrial environment. Standard finish is scratch resistant black wrinkle baked enamel.

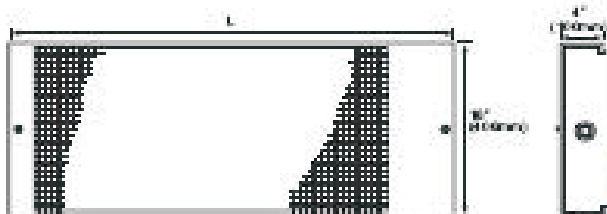

Symmetrical design allows the terminal box to be located at the left or right side of the heater.

SPECIAL FEATURES

Heaters are available without controls for connection to a remote switch or with built-in thermostat.

INSTALLATION

In addition to the reversible terminal enclosure, as a further convenience, heaters include combination brackets (shipped separately) suitable for wall or floor mounting.

When installed, heaters must be spaced not less than 3-5/8" (92mm) from floor or wall. Use supply wires suitable for 90°C.

Sizes

2 - 3 kilowatts.

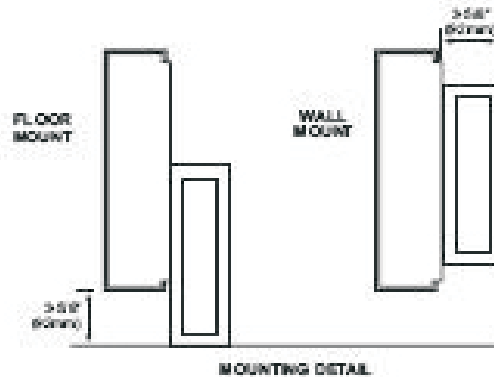

DIMENSION AND TECHNICAL DATA

Size	kW	Volts	P.H.	L		Approx. Ship Weight	
				in.	(mm)	lbs.	(kg)
2S	2	120	1	26 1/2	(673)	30	(15)
		208, 240, 480, 600	1 or 3	26 1/2	(673)	30	(15)
2L	2	208, 240, 480, 600	1 or 3	40	(1016)	30	(15)
		3	3	208, 240, 480, 600	1 or 3	40	(1016)

S=Short Unit, L=Long Unit

TO ORDER:

Specify quantity, model size, voltage, phase and wattage.



Електролукс Electrolux Bitola

Ovoј crtez e сопственост на Electrolux-Bitola. Bez negovo писмено одобрување истаот несмее да се препишува, умножува нити копира без согласност од Electroluks во спротивно се сносат последици во смисланиа членовите 163 и 164 од кривичниот закон R.M. (повреда на авторско право)

Electric Air Duct Heaters

APPLICATION

Reznor air duct heaters are designed for use in comfort heating applications. Typical applications include:

- makeup air heating
- air preheating
- air handling equipment
- fan coils
- terminal reheating
- multi-zone reheating
- heat pump auxiliary systems
- return air heating



Type EDEF



Type EDIF

TYPE EDEF is a flanged duct heater with finned tubular heating elements.

TYPE EDIF is an insert duct heater with finned tubular heating elements.

STANDARD FEATURES

- Primary linear cutout, 160°F (71°C)
277/600 VAC, 25/10 AMP noninductive
- Secondary linear cutout - Manual reset complete with backup magnetic contactor on units under 300V, 30 KW and less, 225°F (107°C)
277/600 VAC, 25/10 AMP noninductive

OPTIONAL AUXILIARY DUCT HEATER CONTROLS

These controls are available as factory installed on the duct heater or as an NEMA rated (specify) control panel for wall mount:

- wall thermostats (1 stage) (2 stage) (0-135 OHM)
- duct thermostats (1 stage) (2 stage) (0-135 OHM)
- bulb holders
- silent contactors
- SCR controllers
- sail switch
- differential pressure switch
- main disconnect
- pneumatic electric switches
- on-off switch
- magnetic contactors
- step controllers
- HRC fusing
- control transformers
- fan interlock relay
- pilot lights
- non-fired tubular heating elements

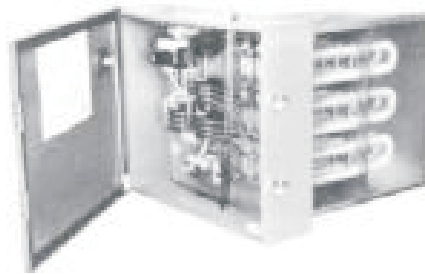

ELEMENT TYPES

The finned tubular element design is the most popular. It incorporates the highest wattage per cross sectional duct area thus making it more economical than the incoloy tubular design.



Figure 1- FINNED TUBULAR ELEMENT

Finned tubular elements are constructed using a steel tube with a corrugated steel fin wrapped around it and brazed together. This increases the heat transfer surface of the element resulting in a lower operating temperature than tubular designs.



Електролукс Electrolux Bitola

Ovoј crtez e сопственост на Electrolux-Bitola. Bez negovo писмено одобрување истиот несмеа да се препишува, умножува нити копира без согласност од Electroluks во спротивно се сносат последици во смисланиа членовите 163 и 164 од кривичниот закон R.M. (повреда на авторско право)

STANDARD DIMENSIONS

Insert type duct heaters are slightly undersized to permit installation in ducts having the A and B dimensions listed in Table 1.



SELECTION AND INSTALLATION

Finned tubular duct heaters are approved for horizontal duct installation where the maximum inlet air temperature does not exceed 25°C (77°F) and the maximum rating does not exceed 120 kW.

Multiple heaters can be installed in tandem (series) provided that the inlet temperature to any heater section (one heater) is not more than 25°C (77°F) and the air velocity is not less than the requirements of Figure 6.

Check with your factory representative if you require assistance.

Figure 6 - AIR VELOCITY REQUIREMENTS

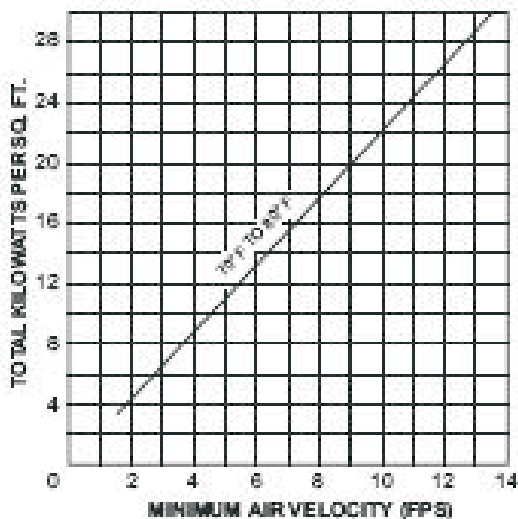

See Table 1 for typical duct heater sizes and kW ratings based on an air flow velocity of 500 ft./min. or higher.

If the flow velocity is less than 500 ft./min, the typical maximum kW ratings in the table must be derated by multiplying the kW ratings shown in Table 1 by the appropriate derating factor from Figure 7.

Electric Air Duct Heaters (cont'd)

Figure 7 - DERATING FACTORS

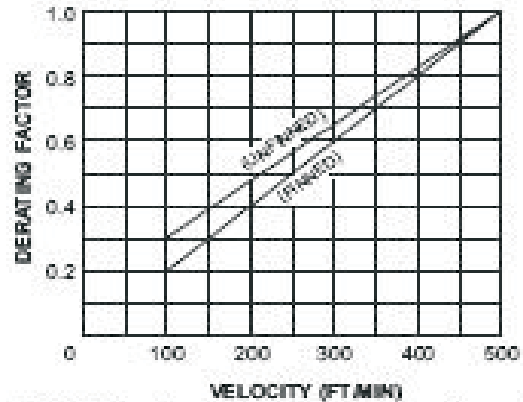

Table 1 below lists some of the more common heater sizes with maximum kilowatt ratings for each size. Stock modular frames allow quick delivery for other sizes in increments of 2".

Table 1 - MAXIMUM SINGLE HEATER kW RATING FOR TYPICAL DUCT HEATERS SIZES

DIMENSIONS INCHES A x B	TYPES EDIPEEIT	
	MAX. kW	MAX. NO. OF ELEMS.
6 x 6	2.5	3
8 x 6	3	3
10 x 6	4	3
10 x 8	5.5	4
12 x 6	5	3
12 x 8	6.5	4
12 x 10	8	5
14 x 8	7.5	4
14 x 10	9.5	5
14 x 12	11.5	6
16 x 10	11	5
16 x 12	13	6
16 x 14	15.5	7
18 x 12	16	6
18 x 14	17.5	7
18 x 16	20	8
20 x 14	18	7
20 x 16	22	8
20 x 18	25	9
22 x 16	24	8
22 x 18	27.5	9
22 x 20	30.5	10
24 x 18	26	9
24 x 20	31	10
24 x 22	36.5	11
26 x 20	26	10
26 x 22	35.5	11
26 x 24	42	12
28 x 22	42.5	11
28 x 24	46.5	12
28 x 26	50.5	13
30 x 24	50	12
30 x 26	54	13
30 x 28	58	14
30 x 30	62.5	15



Електролукс Electrolux Bitola

Electric Air Duct Heaters (cont'd)

Types of EDFF and EDIF duct heaters are designed and approved for comfort heating applications. Unit must be installed in a horizontal duct with the terminal housing at the side or bottom.

Tandem mounting (more than one heater in series) is permitted within certain limitations. See previous discussion.

Units listed in Table 2 are representative only. It is reasonably safe to specify any similar unit using this table as a guideline, and we will build to your specifications.

STANDARD FEATURES

- Primary linear cutout, 160°F (71°C) 277/600 VAC, 25, 10 AMP noninductive
- Secondary linear cutout - Manual reset complete with backup magnetic contactor on units under 300V, 30 kW and less, 225°F

Model EDFF

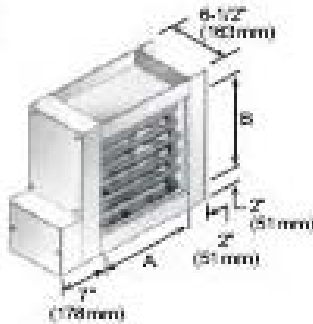

Model EDIF



SIZE	KW	STANDARD VOLTAGES						DIMENSIONS		MINIMUM AIR FLOW		NO. OF ELEM.	APPROX. WEIGHT	
		120V 1Ø	208V 1Ø	240V 3Ø	480V 1Ø	600V 3Ø	A in. (mm)	B in. (mm)	CFM	DM/MIN	LB		KG	
1	1	X	X	n/a	n/a	n/a	6 (152)	6 (152)	50	(1.4)	2	15	(7)	
2	2.5	X	X	X	n/a	n/a	6 (152)	6 (152)	50	(1.4)	2	15	(7)	
7	7.5	n/a	X	X	X	X	14 (356)	8 (203)	350	(9.8)	6	20	(9)	
10	10	n/a	X	X	X	X	14 (356)	12 (305)	450	(12.7)	6	25	(11)	
12	12.5	n/a	X	X	X	X	16 (406)	12 (305)	575	(16.3)	6	30	(14)	
15	15	n/a	X	X	X	X	18 (457)	12 (305)	675	(19.1)	6	30	(14)	
17	17.5	n/a	X	X	X	X	18 (457)	14 (356)	800	(22.7)	6	35	(16)	
20	20	n/a	X	X	X	X	18 (457)	16 (406)	900	(25.5)	6	35	(16)	
25	25	n/a	n/a	X	X	X	20 (508)	18 (457)	1125	(31.9)	9	50	(23)	
30	30	n/a	n/a	X	X	X	24 (610)	18 (457)	1350	(38.2)	9	55	(25)	
35	35	n/a	n/a	X	X	X	24 (610)	22 (559)	1575	(44.6)	9	60	(27)	
40	40	n/a	n/a	X	X	X	26 (660)	24 (610)	1800	(52.4)	12	70	(32)	
45	45	n/a	n/a	X	X	X	28 (711)	24 (610)	2025	(57.3)	12	75	(34)	
50	50	n/a	n/a	X	X	X	28 (711)	26 (660)	2500	(68.1)	12	80	(36)	
60	60	n/a	n/a	X	X	X	30 (762)	30 (762)	3000	(83.3)	15	95	(43)	
80	80	n/a	n/a	X	X	X	36 (914)	32 (813)	3600	(101.9)	15	105	(48)	
100	100	n/a	n/a	X	X	X	42 (1067)	36 (914)	4500	(128.8)	18	130	(59)	
120	120	n/a	n/a	X	X	X	48 (1219)	36 (914)	5400	(152.9)	18	150	(68)	



Електролукс Electrolux Bitola

Ovoј crtez e сопственост на Electrolux-Bitola. Bez negovo pismeno одобруvanje istiот nesmee da se prepisuva, umnozuva niti kopira bez soglasnost od Elctroluks vo sproftivo se snosat posledici vo smislana clenovite 163 i 164 od kivicniот zakon R.M. (повreda na avtorsko pravo)

Electric Radiant Heaters

GENERAL INFORMATION

The major benefit of infrared heating is its ability to transfer heat to a person or object without heating the surrounding air.

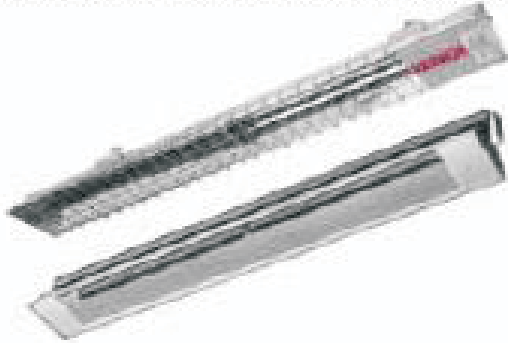

As an example, a person doing heavy work requires an air temperature of 66-68°F to maintain the feeling of warmth, but to provide the same feeling of warmth with infrared heating requires an air temperature of only 55-60°F.

Normal Air Type of Work	Normal Air Temperature	Equivalent Temperature with Infrared Heating
Heavy Work	66-68°F	55-60°F
Light Work	70-72°F	60-62°F
Seated	74-76°F	65-70°F
Swimming Pool	85-90°F	75-80°F

DANGER-HAZARD OF FIRE - AVOID DIRECT CONTACT OF HEATER CASE WITH ANY COMBUSTIBLE SURFACES. ENERGIZED HEATERS SHOULD BE SPACED SO THAT NO COMBUSTIBLE SURFACES EXCEED 194°F (90°C). SEE INSTALLATION INSTRUCTIONS.

FEATURES

Reznor electric infrared heaters are available in a wide variety of fixtures with a choice of metal sheathed (type C), quartz tube (type QT), or quartz lamp (type QL) heating elements. Quartz lamp heaters are more efficient than quartz tube heaters which are in turn more efficient than metal tube heaters.

Where vibration or mechanical shock risk exists, do not use quartz tube or quartz lamp heaters. Use metal sheathed heaters in these instances. Terminal ends must be protected from severe moisture or contaminating vapors. Use heaters with moisture resistant terminal housings in these environments.

Two fixture types are available. The deep reflector type gives better radiation at greater than normal mounting height.

LIFE EXPECTANCY

The normal life expectancy of a radiant heater depends, in part, on heater watt density and operating conditions. Applications characterized by high ambient temperatures or frequent switching are the most demanding. Note that the heaters are warranted only for defects in material and workmanship. Estimates on life expectancy for a particular application are available on request.

APPLICATION

In general, the application of infrared heaters is complex and allowances must be made for in-field adjustments to output intensity and heater positioning.

Figure 1 - Recommended installed watts/sq. ft. of floor area using quartz lamp heaters

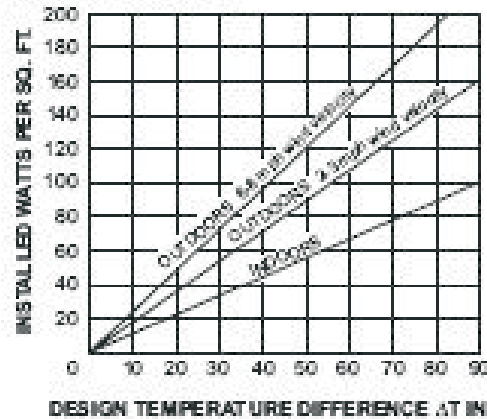

Spaceheating applications are reasonably straight forward. Pay close attention to the energy spread to achieve maximum utilization.

For process heating applications, it may be necessary to run a series of test to establish the most satisfactory heating method. Your Reznor Representative can help you to achieve the best results.

ENERGY SPREAD

Use the table below to determine the effective energy spread for the 45°, 60° and 70° fixtures. Proper applications of this information will help in establishing an efficient layout for uniform infrared coverage of the product or space.

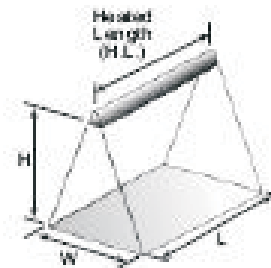

Table 1 - RADIANT COVERAGE AT VARIOUS HEIGHTS

SPREAD ANGLE	WIDTH (W)	LENGTH (L)
45°	.83 x H	H + HL*
60°	1.15 x H	H + HL*
70°	1.4 x H	H + HL*

* See listing for H, L. (Heated Length).



Електролукс Electrolux Bitola

Electric Radiant Heaters (cont'd)

SELECTION

APPLICATION	Tubular Element	Quartz Tube Element	Quartz Lamp Element
COMFORT HEATING APPLICATIONS			
Arcade	X		
Assembly areas	X		X
Auditoriums	X	X	X
Bathrooms		X	
Booth	X	X	
Bowling alleys	X	X	X
Brooders for chickens, etc.	X	X	
Building entrances	X		X
Car washes and stations	X	X	X
Car washes especially coin operated	X		X
Churches (especially rural)	X	X	
Concessions (restaurants, bars, etc.)	X	X	X
Entrances	X		X
Exhibition halls	X		X
Factories	X		X
Farm animals	X		X
Farm shops	X	X	
Gardens	X		X
Globes	X		X
Greenhouses	X		X
Grandstands			X
Greenhouses	X		X
Hot pans	X		X
Hospital emergency entrances			X
Hotel entrances	X		X
Loading platforms			X
Milk parlors	X	X	
Outdoor cafes		X	X
Refrigerators	X		
Refrigerators	X		
Shoe making (refer to factory)			X
Spot heating, indoor	X	X	X
Spot heating, outdoor	X		X
Stadiums			X
Subway entrances	X		X
PROCESS HEATING APPLICATIONS			
Baking (concrete radiant mats)	X	X	
Baking (concrete) painted plastic or wood		X	X
Baking cakes, etc.			X
Bleaching vegetation			X
Boiling temperatures in cooking ovens	X		
Broiling chickens, etc.			X
Chemical systems	X	X	X
Chemical systems	X		X
Distributing	X		X
Drying abrasive powder	X		
Drying concentrates	X		
Drying paint on powder (e.g. envelopes and tissues)			X
Drying paint on textiles - heavy	X	X	X
Drying paint on textiles - light		X	X
Drying paint or print on paper, plastic		X	X
Drying soil, clay, sand, etc.	X		
Hot drying in ceramic processes	X		
Incubation in chicken, broilers, etc.	X		
Milking machines (refer to factory)			X
Mime coating	X		
Paper machinery			X
Refrigerators, etc.			X
Refrigerators (refer to factory)	X		
Risk screen drying			X
Thawing frozen ore or coal in railroad cars for water dumps	X		X
Thawing ice			X
Thawing soil			X
Vacuum formation	X		

Page 16

CONTROL OPTIONS

PERCENTAGE TIMERS

Percentage timers (input controllers) are used mainly for pulsing power to metal tubular element type radiant heaters. Where load voltage and current ratings exceed the timer's contact rating, the timer can be used to switch a contactor(s). Percentage timers can not be effectively used on quartz lamp type radiant heaters and have restricted use on quartz tube type heaters.

The percentage timer features a synchronous motor driven cam which closes a snap action switch for a percentage of 30 second "on" time. The adjustment knob sets the pointer to an "on" time of 0 to 100%. For instance, a timer set to 50% (mid scale) would allow full voltage to the heater(s) for 15 seconds and no voltage for 15 seconds thus reducing the average heat output. Standard features include a plug-in style mounting, an electrically isolated pilot light and a cycle progress pointer. Check factory for details on ordering.

THERMOSTATIC CONTROL

Thermostatic control is used primarily for indoor applications and consists of an indoor thermostat, or an indoor thermostat combined with an outdoor thermostat. Rooms heated with infrared heaters can normally be maintained at lower temperatures and still be in the comfort range.

Thermostats should be located in the area to be heated but not directly exposed to the heater beam pattern. Thermostats may be shielded by placing a reflective cover over top.

Thermostatic controls can be used in conjunction with a percentage timer for cost efficient space heating. Two thermostats (or one two stage thermostat) are required.

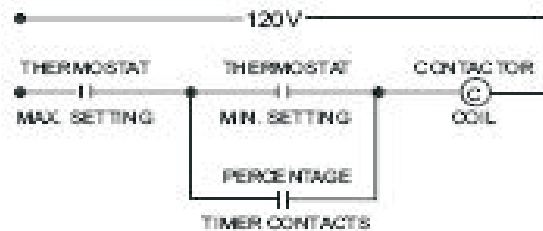

In the above circuit, one thermostat is set at the maximum required room temperature and one is set at the minimum desired room temperature. The input controller is adjusted to provide modulated infrared heat when the space temperature is between the above limits.

STEP AND CONTINUOUS CONTROL

Larger installations may require custom control panels for more sophisticated zone control using staging and SCRs. Consult your nearest Remor representative to aid you in selecting the proper type of control for your individual requirements.

Ovoj crtez e sopstvenost na Electrolux-Bitola.Bez negovo pismeno odobruvanje istiot nesmee da se prepisuvava, umozuva niti kopira bez soglasnost od Electroluks vo sproitivno se snosati posledici vo smislana clenovite 163 i 164 od kriticniot zakon R.M. (povreda na avtorsko pravo)

Браќа Минѓови бр.18, Стара Царица, Битола. Г.Т.Ц.Бунјаковец Скопје
Тел/Факс: 047/203-900; 203-330; 070/237-108
Тел/Факс: 02/329 8 130; 070/237 198

www.electroluks.com.mk, www.electrolux.com.mk, electrolux@mt.net.mk

Electroluks is registered trademark of Elektroluks companies in Macedonia and other countries



Електролукс Electrolux Bitola

Electric Radiant Heaters (cont'd) Process Heating

ERI SERIES

APPLICATIONS

Resistor series ERI electric infrared radiant heaters are primarily designed for industrial applications such as:

- conveyorized or batch type ovens
- degreasing
- weld preheating
- roll heating
- curing, drying, softening of resins, vinyls, and plastics
- baking, drying, curing of paint, lacquers and adhesives
- defrosting soil prior to pouring concrete
- curing concrete in winter construction
- thawing ore and coal in railroad cars for easier dumping

Model ERIC



WIRE GUARD AVAILABLE
(CHECK FACTORY)

DANGER-HAZARD OF FIRE - AVOID DIRECT CONTACT OF HEATER CASE WITH ANY COMBUSTIBLE SURFACES. ENERGIZED HEATERS SHOULD BE SPACED SO THAT NO COMBUSTIBLE SURFACES EXCEED 194°F (90°C). SEE INSTALLATION INSTRUCTIONS.

FEATURES

Available with a choice of single or dual incoloy tubular elements, quartz tubes, or quartz lamps. Anodized and chemically brightened extruded aluminum reflector. Custom mounting frames and carts to suit individual requirements can be provided upon request (check factory).

For wiring, use standard 200°C supply wires.

ERIC - SINGLE TUBULAR ELEMENT

Generally used in conveyorized or batch type process heating applications requiring far infrared for drying or curing where a small economical unit is preferred. The mineral insulated alloy sheath heating element enables the unit to withstand splashing and vibration and is the most durable of the three heat sources.

SIZE	KW	STANDARD VOLTAGES	OVERALL LENGTH in. (mm)	HEATED LENGTH in. (mm)	SHIPPING WEIGHT lb. (kg)
10	0.95	120, 208, 240	29 (737)	20 (508)	2.5 (1.1)
15	1.5		41 (1041)	32 (813)	3.4 (1.5)
19	1.9		47 (1194)	38 (965)	4.2 (1.9)
20	2.0	208, 240, 480, 600	41 (1041)	32 (813)	3.8 (1.7)
23	2.3		47 (1194)	38 (965)	4.3 (2.0)
30	3.0		59 (1499)	50 (1270)	5.2 (2.4)
38	3.8	71 (1803)	62 (1575)	6.2 (2.8)	

NOTE: For 45° spread, order option TM1.

For 60° spread, order option TM2.

Model ERIE

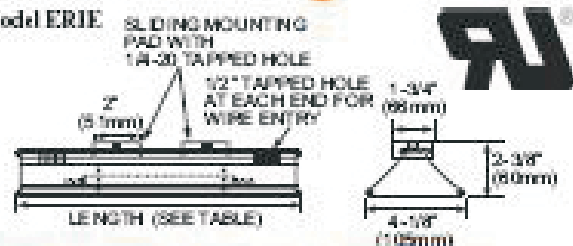

ERIE - DOUBLE TUBULAR ELEMENT

With two series wired heating elements in each reflector, these units are normally used in industrial applications where a rugged, efficient, high heat concentration is required. Applications include degreasing, weld preheating, roll heating, drying, sterilization, etc.

SIZE	KW	STANDARD VOLTAGES	OVERALL LENGTH in. (mm)	HEATED LENGTH in. (mm)	SHIPPING WEIGHT lb. (kg)
18	1.8	208, 240, 480, 600	29 (737)	20 (508)	3.5 (1.6)
32	3.2		41 (1041)	32 (813)	4.8 (2.2)
38	3.8		47 (1194)	38 (965)	5.4 (2.5)
50	5.0	59 (1499)	50 (1270)	6.7 (3.0)	
62	6.2	71 (1803)	62 (1575)	8.0 (3.6)	

ERIR - HAIRPIN TUBULAR ELEMENT WITH MOISTURE RESISTANT TERMINAL HOUSING

Type R heaters are for use in outdoor installations or areas subject to periodic wash-down.

WIRE GUARD OPTIONAL.



SIZE	KW	STANDARD VOLTAGES	OVERALL LENGTH in. (mm)	HEATED LENGTH in. (mm)	SHIPPING WEIGHT lb. (kg)
11	1.1	208, 240, 480, 600	18 1/4 (463)	14 (356)	2.9 (1.3)
16	1.6		21 1/4 (540)	19 (483)	4.8 (2.2)
21	2.1		29 1/4 (743)	25 (635)	5.4 (2.5)
25	2.5	33 1/4 (844)	29 (737)	5.8 (2.6)	
30	3.0	38 1/4 (971)	34 (864)	6.4 (2.9)	
36	3.6	45 1/4 (1149)	41 (1041)	7.1 (3.2)	
53	5.3	63 1/4 (1606)	59 (1499)	9.1 (4.1)	
65	6.5	75 1/4 (1911)	71 (1803)	10.4 (4.7)	

DANGER-HAZARD OF FIRE - AVOID DIRECT CONTACT OF HEATER CASE WITH ANY COMBUSTIBLE SURFACES. ENERGIZED HEATERS SHOULD BE SPACED SO THAT NO COMBUSTIBLE SURFACES EXCEED 194°F (90°C). SEE INSTALLATION INSTRUCTIONS.

TO ORDER SPECIFY:

Quantity, model, size, voltage and wattage.

Ovoј crtez e сопственост на Electrolux-Bitola. Bez negovo писмено одобрување истиот несмеа да се препишува, умножува нити копира без согласност од Electroluks во сродноство со сносат поседници во смислана членовите 163 i 164 од кривичниот закон R.M. loovreda на авторско право



Електролукс Electrolux Bitola

Ovoј crtez e сопственост на Electrolux-Bitola. Bez negovo писмено одобрување истаот несмее да се препишува, умножува нити копира без согласност од Electroluks во спротивно се сносат последици во смисланиа закон R.M. (повреда на авторско право)

Electric Radiant Heaters Process Heating (cont'd)

ERI SERIES (cont'd)

ERIQT - QUARTZ TUBE ELEMENT

These units are commonly used in industrial applications where medium intensity infrared heat is required such as paint spray booths, curing, drying and softening of resins, vinyls, or plastics.

Quartz tube features must be mounted horizontally.



SIZE	KW	STANDARD VOLTAGES	OVERALL LENGTH		HEATED LENGTH		SHIPPING WEIGHT	
			in.	(mm)	in.	(mm)	lb.	(kg)
8	0.8	120, 208, 240	25	(635)	16	(406)	2.6	(1.2)
16	1.6	240	41	(1041)	32	(813)	3.8	(1.7)
25	2.5	208, 240, 480, 600	59	(1499)	50	(1270)	5.0	(2.3)
31	3.1		71	(1803)	62	(1575)	5.8	(2.6)

ERIQF - TWO QUARTZ TUBE ELEMENTS

For use in applications where high intensity heat is required but the light emitted by quartz lamps would be objectionable.

Quartz tube features must be mounted horizontally.



SIZE	KW	STANDARD VOLTAGES	OVERALL LENGTH		HEATED LENGTH		SHIPPING WEIGHT	
			in.	(mm)	in.	(mm)	lb.	(kg)
16	1.6	120, 208, 240	25	(635)	16	(406)	3.2	(1.5)
12	1.2	240	41	(1041)	32	(813)	4.6	(2.1)
50	5	208, 240, 480, 600	59	(1499)	50	(1270)	6.1	(2.8)
62	6.2		71	(1803)	62	(1575)	7.1	(3.2)

ERIQL - QUARTZ LAMP ELEMENT

These are widely used in industrial applications where high intensity radiation is required and where it is essential to turn the heat on or off instantaneously. They are commonly used for baking, drying and curing items such as paint, varnishes, lacquers, and adhesives, for softening plastics and for food processing.



SIZE	KW	STANDARD VOLTAGES	OVERALL LENGTH		HEATED LENGTH		SHIPPING WEIGHT	
			in.	(mm)	in.	(mm)	lb.	(kg)
5	0.5	120, 208, 240	14	(356)	5	(127)	1.9	(0.9)
10	1.0		18	(463)	10	(254)	2.2	(1.0)
1.6	1.6		25	(635)	16	(406)	2.6	(1.2)
25	2.5	480, 600	34	(864)	25	(635)	3.3	(1.5)
38	3.8	600	47	(1194)	38	(965)	4.2	(1.9)

ERIH SERIES

APPLICATIONS

The ERIH infrared radiant heater is used where an extra high density rugged heat source is required. It is suited for process or comfort heating.

FEATURES

This unit features two incooly tubular elements which are designed for operation under severe working conditions. Thermal insulation decreases heat losses, increases efficiency, and reduces power required. Tarnish free, high lustr, aluminum reflector increases efficiency by concentrating energy on the area to be heated (energy spread approx. 60°).



MODEL ERIH



WIRE GUARD AVAILABLE
(CONTACT YOUR FACTORY REPRESENTATIVE)

Models are available with general purpose or weatherproof terminal boxes to meet a wide variety of special process heating applications.

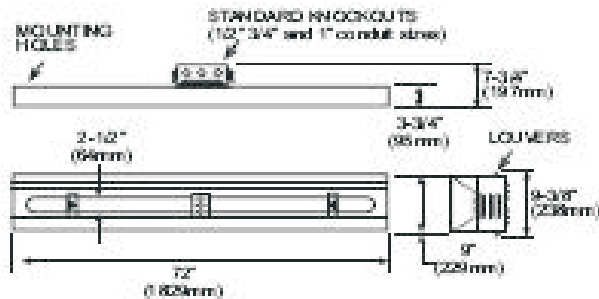

SIZE	KW	STANDARD VOLTAGES	SHIPPING WEIGHT	
			lb.	(kg)
64	6.4	208, 240, 480, 600	38	(17.4)
80	8.0		38	(17.4)
100	10.0		38	(17.4)

DANGER-HAZARD OF FIRE - AVOID DIRECT CONTACT OF HEATER CASE WITH ANY COMBUSTIBLE SURFACES. ENERGIZED HEATERS SHOULD BE SPACED SO THAT NO COMBUSTIBLE SURFACES EXCEED 194°F (90°C). SEE INSTALLATION INSTRUCTIONS.

TO ORDER SPECIFY:

Quantity, model, size, voltage and wattage.



Електролукс Electrolux Bitola

Electric Radiant Heaters (cont'd) Comfort Heating

ERE - DOUBLE TUBULAR ELEMENT

ER SERIES

APPLICATIONS

- outdoor grandstands
- indoor arenas
- indoor pools
- churches and halls
- patios
- outdoor shelters
- spot heating in large unheated buildings and garages
- entry vestibules
- store front snow melting
- warehouse loading bays
- work areas in farm buildings

FEATURES

All units are available with incoloy tubular, quartz tube, or quartz lamp type elements. Extruded aluminum, anodized and chemically brightened reflectors are standard. Tilting accessories are not required; units come complete with swivel bracket and set screw adjustment. Eyebolts are supplied for chain mounting. Units may also be surface mounted to recessed outlet box on noncombustible surfaces. Use 90°C wires.

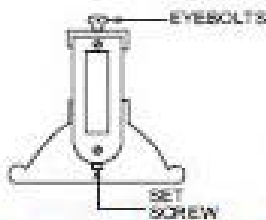

Tilting accessories are not required. Simply adjust set screw at one end to achieve desired degree horizontal tilting. Eyebolts with holes for chain mounting are provided.

ERC - SINGLE TUBULAR ELEMENT

Commonly used for indoor spot heating applications where a great amount of heat is not required and where the mounting height is relatively low. Example installations would include churches, garages, and indoor pools.

SIZE	kW	STANDARD VOLTAGES	OVERALL LENGTH		HEATED LENGTH		SHIPPING WEIGHT
			in.	(mm)	in.	(mm)	
10	0.95	120, 208, 240	31 1/2	(800)	29	(598)	5.1 (2.3)
15	1.5		43 1/2	(1103)	32	(813)	6.8 (3.1)
19	1.9		49 1/2	(1257)	38	(965)	8.0 (3.6)
20	2.0	208, 240, 480, 600	43 1/2	(1103)	32	(813)	7.2 (3.3)
21	2.1		49 1/2	(1257)	38	(965)	8.1 (3.7)
30	3.0		61 1/2	(1562)	50	(1270)	9.9 (4.5)
38	3.8		73 1/2	(1867)	62	(1575)	11.7 (5.3)

NOTE: For 45° spread, order option TM1.

For 60° spread, order option TM2.

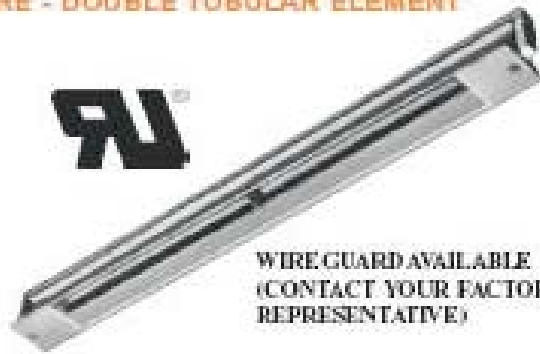

WIRE GUARD AVAILABLE
(CONTACT YOUR FACTORY REPRESENTATIVE)

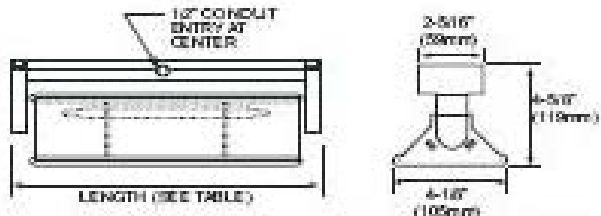

Ideal for heating small indoor areas where a more intense heat is required and where the light emitted by a quartz lamp would be objectionable.

SIZE	kW	STANDARD VOLTAGES	OVERALL LENGTH		HEATED LENGTH		SHIPPING WEIGHT
			in.	(mm)	in.	(mm)	
18	1.80	208, 240, 480, 600	31 1/2	(800)	29	(598)	6.0 (2.7)
32	3.2		43 1/2	(1103)	32	(813)	8.2 (3.7)
38	3.8		49 1/2	(1257)	38	(965)	9.2 (4.2)
50	5.0		61 1/2	(1562)	50	(1270)	11.4 (5.2)
62	6.2		73 1/2	(1867)	62	(1575)	14 (6.3)

ERQT - QUARTZ TUBE

Ideal for indoor and outdoor applications where fast heat up and no light is required such as canopies, patios and garages.

Quartz tube fixtures must be mounted horizontally.

SIZE	kW	STANDARD VOLTAGES	OVERALL LENGTH		HEATED LENGTH		SHIPPING WEIGHT
			in.	(mm)	in.	(mm)	
8	0.8	120, 208, 240	27 1/2	(699)	16	(406)	4.9 (2.2)
16	1.6		43 1/2	(1103)	32	(813)	7.1 (3.2)
25	2.5	208, 240, 480, 600	61 1/2	(1562)	50	(1270)	9.7 (4.4)
31	3.1		73 1/2	(1867)	62	(1575)	11 (5.0)

TO ORDER SPECIFY:

Quantity, model, size, voltage and wattage.



Ovoј crtez e сопственост на Electrolux-Bitola. Bez negovo писмено одобрување истиот несмеа да се препишува, умножува нити копира без согласност од Electroluks во спротивно се сносат последици во смислana членовите 163 и 164 од кривичниот закон R.M. (повреда на авторско право)

Electroluks is registered trademark of Elektroluks companies in Macedonia and other countries

Браќа Минѓови бр.18, Стара Царица - Битола. Г.Т.Ц. Бунјаковец Скопје
Тел/Факс: 047/203-900; 203-330; 070/237-108
Тел/Факс: 02/329 8 130; 070/237 198

www.elektroluks.com.mk, www.electrolux.com.mk, electrolux@mt.net.mk



Електролукс Electrolux Bitola

Ovoј crtez e сопственост на Electrolux-Bitola. Bez negovo писмено одобрување истиот несмеј да се препишува, умножува нишј копира без согласност од Electroluks во спротивно се сносат последици во смисла на членовите 163 и 164 од Кривичниот закон Р.М. (повреда на авторско право)

Electric Radiant Heaters Comfort Heating (cont'd)

ERQL - QUARTZ LAMP

For use in indoor or outdoor comfort heating applications where the mounting height is greater than 15 ft. and a small compact unit is required.



MODEL ERQL - 60° SPREAD

SIZE	kW	STANDARD VOLTAGES	OVERALL LENGTH		HEATED LENGTH		SHIPPING WEIGHT	
			in.	(mm)	in.	(mm)	lb.	(kg)
5	0.5	120	16 1/2	(419)	5	(127)	3.4	(1.5)
10	1.0	208, 240	21 1/2	(547)	10	(254)	4.1	(1.9)
16	1.6		27 1/2	(699)	16	(406)	4.9	(2.2)
23	2.3	480, 600	36 1/2	(927)	23	(583)	6.2	(2.8)
38	3.8	600	49 1/2	(1257)	38	(965)	8.0	(3.6)

ERH SERIES - HEAVY DUTY

ERHC - INCOLOY TUBULAR ELEMENT

Ideal for arenas and other indoor applications where a larger, more rugged unit is required and where the light emitted from a quartz lamp would be objectionable. Excellent for indoor comfort heating applications such as factory work stations or isolated service booths where good temperature control is required.

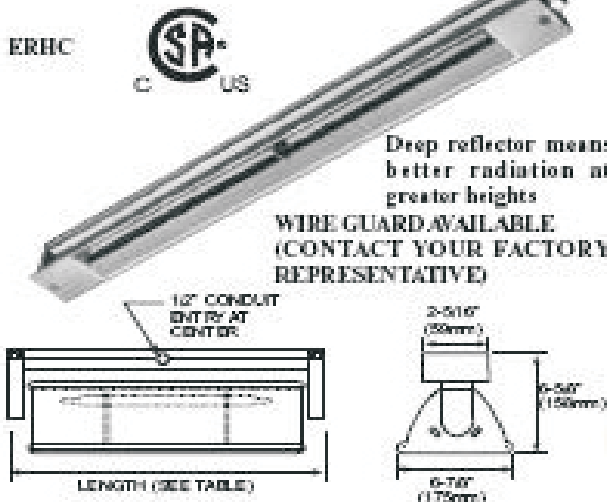

SIZE	kW	STANDARD VOLTAGES	OVERALL LENGTH		HEATED LENGTH		SHIPPING WEIGHT	
			in.	(mm)	in.	(mm)	lb.	(kg)
10	0.95	120, 208,	31 1/2	(800)	20	(508)	7.7	(3.5)
15	1.5	240	43 1/2	(1103)	32	(813)	10.2	(4.6)
18	1.8		49 1/2	(1257)	38	(965)	11.9	(5.4)
20	2.0		43 1/2	(1103)	32	(813)	10.8	(4.9)
23	2.3	208, 240,	49 1/2	(1257)	38	(965)	11.9	(5.4)
30	3.0	480, 600	61 1/2	(1562)	42	(1067)	14.8	(6.7)
38	3.8		73 1/2	(1867)	52	(1321)	17.9	(8.1)

NOTE: For 45° spread, order option TM1.

For 70° spread, order option TM3.

Page 20

ERHR - HAIRPIN TUBULAR ELEMENT WITH MOISTURE RESISTANT TERMINAL HOUSING

Model ERHR heaters, featuring a hair-pin shaped element in a moisture resistant housing, provide a high heat concentration minimizing the number of heaters required. Suitable for outdoor or indoor installation. Note that this model does not have the tilting fixture. Sliding mounting pads with hooks are provided.



ERHQT - QUARTZ TUBE ELEMENT

Used in applications similar to the quartz lamp where light emitted by the lamp would be undesirable. Maintains high density at greater than normal mounting heights.

Quartz tube fixtures must be mounted horizontally.



SIZE	kW	STANDARD VOLTAGES	OVERALL LENGTH		HEATED LENGTH		SHIPPING WEIGHT	
			in.	(mm)	in.	(mm)	lb.	(kg)
8	0.8	120, 208,	27 1/2	(699)	16	(406)	7.2	(3.3)
16	1.6	240	43 1/2	(1103)	32	(813)	10.8	(4.9)
23	2.3	208, 240,	61 1/2	(1562)	50	(1270)	14.3	(6.5)
31	3.1	480, 600	73 1/2	(1867)	62	(1573)	16.8	(7.6)

NOTE: For 45° spread, order option TM1.

For 70° spread, order option TM3.

DANGER-HAZARD OF FIRE - AVOID DIRECT CONTACT OF HEATER CASE WITH ANY COMBUSTIBLE SURFACES. ENERGIZED HEATERS SHOULD BE SPACED SO THAT NO COMBUSTIBLE SURFACES EXCEED 194°F (90°C). SEE INSTALLATION INSTRUCTIONS.

TO ORDER SPECIFY:

Quantity, model, size, voltage and wattage.

Браќа Минѓови бр.18, Стара Царница - Битола. Г.Т.Ц. Бунјаковец Скопје
Тел/Факс: 047/203-900; 203-330; 070/237-108
Тел/Факс: 02/329 8 130; 070/237 198

www.elektroluks.com.mk, www.electrolux.com.mk, electrolux@mt.net.mk

Electroluks is registered trademark of Elektroluks companies in Macedonia and other countries



Ovoј crtez e сопственост на Electroлux-Bitola. Bez negovo писмено одобрување истиот несмее да се препишува, умножува нити копира без согласност од Electroлuks во спротивно се сносат последици во смисла на членовите 163 и 164 од Кривичниот закон Р.М. (повреда на авторско право)

Technical Data Electrical Circuits

ELECTRICAL EQUATIONS

Single phase relationships:

$$V = \sqrt{WR} = W \div I = IR$$

$$RW \div I^2 = V^2 \div W = V \div I$$

$$I = V \div R = W \div V = \sqrt{W \div R}$$

$$W = V^2 \div R = I^2 R = VI$$

For current in electrically balanced three phase A.C. circuits:

$$I = \frac{W}{V(\sqrt{3})}$$

NOTE: For circuits wired in 3 phase delta, wattage may be reduced to 1/3 by rewiring to a 3 phase wye connection.

FIG. 1 - THREE PHASE DELTA CONNECTION

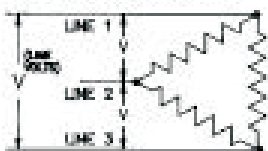

FIG. 2 - THREE PHASE WYE OR STAR CONNECTION

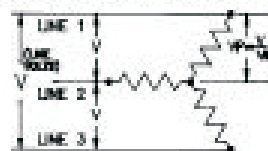

FIG. 3 - SPECIAL USE OF TWO POLE THERMOSTAT

Single phase circuit split with half of the current load across each thermostat contact.

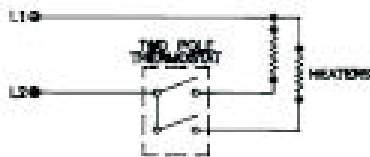

FIG. 4 - USE OF CONTACTOR (SINGLE PHASE)

Single phase circuit for conditions where the line current exceeds the thermostat rating and a contactor is added.

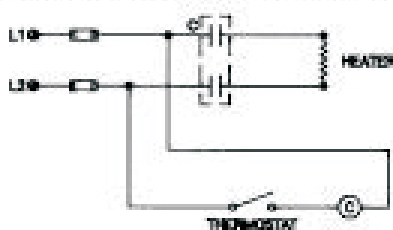

FIG. 5 - USE OF CONTACTOR (THREE PHASE)

Three phase circuit for conditions where the line current exceeds the thermostat rating and a contactor is added.

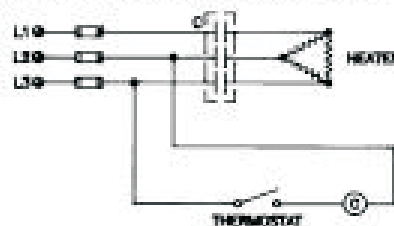

FIG. 6 - SERIES TO PARALLEL DELTA TRANSFORMATION

Special circuit with two thermostats and two contactors. When both contactors are closed, elements are wired in 3 phase parallel delta and circuit operates at full power. When only one of the contactors is closed, elements are wired in 3 phase series delta and the circuit operates at 1/4 power.

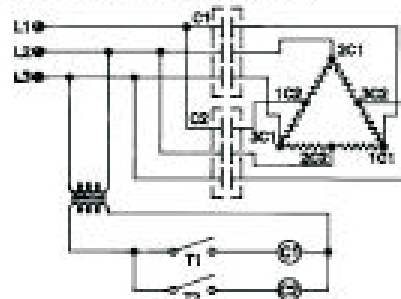
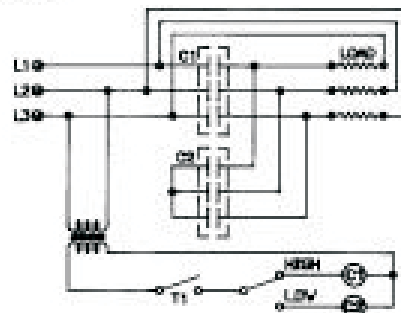

FIG. 7 - WYE TO DELTA TRANSFORMATION

Special circuit with two contactors, thermostat and two position switch.

When contactor 1 (C1) is closed, elements are wired in 3 phase delta and circuit operates at full power. When contactor 2 (C2) is closed, contactor 1 (C1) is opened, elements are wired in 3 phase wye and the circuit operates at 1/3 power. CAUTION: Contactors C1 and C2 must be mechanically interlocked in this configuration.





Електролукс Electrolux Bitola

Ovoј crtez e сопственост на Electrolux-Bitola. Bez negovo писмено одобрување истиот несмее да се препишува, умножува нити копира без согласност од Electroluks во спротивно се сносат последици во смисла на членовите 163 и 164 од кривичниот закон R.M. (повреда на авторско право)



Model EGE

Sizes 2-10 kW have 5 louvers. Sizes 10-40 have seven louvers.

APPLICATION

The Resnor fan forced EGE unit heater is designed for use in regular duty industrial and commercial space heating applications. This heater features the Resnor robust design which surpasses the standards of most competitive models.

If the environment is particularly demanding, the Resnor model EGH heater is recommended.

Resnor Model EGE is designed for use in commercial or industrial (nonhazardous) heating applications. Typical applications include:

- factories
- warehouses
- parking garages
- boiler rooms
- arenas
- grandstands
- mechanical rooms
- shopping malls
- display areas
- stores

FEATURES

- 2 kW to 40 kW output
- 208V to 600V - 1 or 3 phase
- field convertible from 1 to 3 phase
- permanently lubricated motors
- phosphate coated steel for rust protection
- epoxy painted (ASA 61 Grey)
- optional thermostats and controls
- optional ceiling and wall brackets
- motors mounted outside element bundle
- tubular heating elements
- adjustable air flow louvers
- overheat protection

MOUNTING BRACKETS

- Wall Mounting Bracket available for all sizes.
- Ceiling Mounting Brackets available for all sizes.

Page 4

Model EGE

Electric, Forced-Air, Unit Heater, Standard Duty

MOTORS

- 2 - 10 kW heaters are standard with dual rated motors; 208/240V single phase. Where necessary, transformers are used to provide proper motor voltage.
- 15 - 40 kW heaters are standard with single phase full voltage rated motors.
- standard motors have permanently lubricated bearings and built-in thermal overloads.
- totally enclosed ball bearing motors are standard.
- motor RPM - 1550 unless otherwise stated.
- motor HP
 - 2 to 10kW - 1/20 HP
 - 15 to 40 kW - 1/10 HP
 - other ratings available, check factory.

CONTACTORS AND TRANSFORMERS

- Factory installed contactors are available when required.
- Transformers are standard when primary voltage is not suitable for motor operation or contactor coil ratings.
- Standard control voltage is 240V.

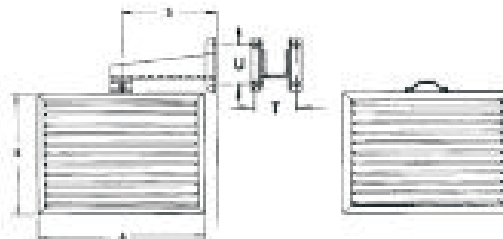

TABLE 1 - DIMENSIONS - in. (mm)

HEATER RATING kW	A	B	C DEPTH	BOLT SIZE	HOLE DIA.	S	T	U
2-10	17 (432)	14 (356)	15 1/2 (394)	1/2-20x3 N.C.	9/16 (14)	12 1/2 (318)	4 1/2 (114)	4 1/2 (114)
15 - 40	24 (610)	19 1/2 (495)	22 (559)	3/4-20x10 N.C.	7/8 (22)	17 1/2 (445)	6 (152)	6 (152)

TABLE 2 - HEIGHT & WEIGHT

kW	NORMAL MOUNTING HEIGHT ft (m)	SHIPPING WEIGHT lbs. (kg)
2-10	6 - 8 (1.8 - 2.4)	50 (24)
15 - 40	8 - 12 (2.4 - 3.0)	104 (47)

Браќа Минѓови бр.18, Стара Царица Битола. Г.Т.Ц.Бунјаковец Скопје
Тел/Факс: 047/203-900; 203-330; 070/237-108
Тел/Факс: 02/329 8 130; 070/237 198

www.elektroluks.com.mk, www.electrolux.com.mk, electrolux@mt.net.mk

Electroluks is registered trademark of Elektroluks companies in Macedonia and other countries



Електролукс Electrolux Bitola

Ovoј crtez e сопственост на Electrolux-Bitola. Bez negovo писмено одобрување истиот несмее да се препишува, умножува нити копира без согласност од Electroluks во спротивно се сносат последици во смисла на членовите 163 и 164 од кривичниот закон R.M. (повреда на авторско право)

Electric Air Duct Heaters (cont'd)

Figure 2 - TUBULAR ELEMENT



Incoloy tubular elements are similarly constructed, but without the steel fin in order to increase the corrosion resistance.

The incoloy design should be chosen where high humidity or slightly corrosive chemical contaminants are present in the air stream. These units are made and approved on special order only.

Both element types are designed to provide many years of maintenance free service.

Unlike open coil designs, duct heaters fitted with tubular elements are not subject to hazards of electrical shock which allows installation close to a register or grille.

RECOMMENDED KILOWATTS

In order to select the proper kW for your applications, use Figure 3 below.

Figure 3 - RECOMMENDED KILOWATTS

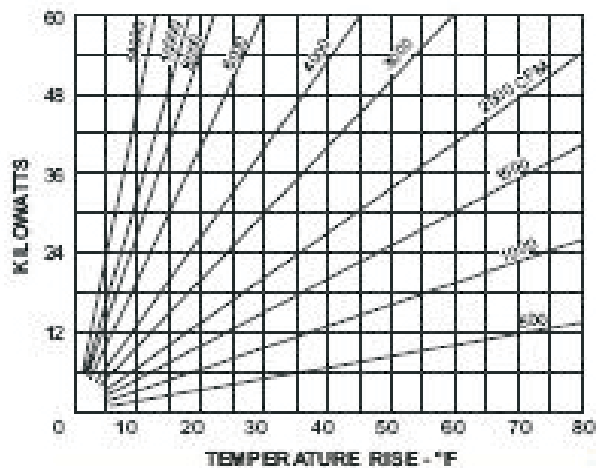

Page 12

WIRING AND AUXILIARY CONTROLS

Reznor electrical duct heaters are available for supply voltages up to 600V, 3 phase. Multi-staging to provide increments of temperature rise can be incorporated where dimensional space and element spacing allows. Special electrical features are available providing simple or sophisticated temperature control to suit individual requirements. See optional controls.

CONSTRUCTION

Two basic heater frame constructions are available, flange type or insert type (see Figures 4 and 5 below).

Figure 4 - INSERT TYPE

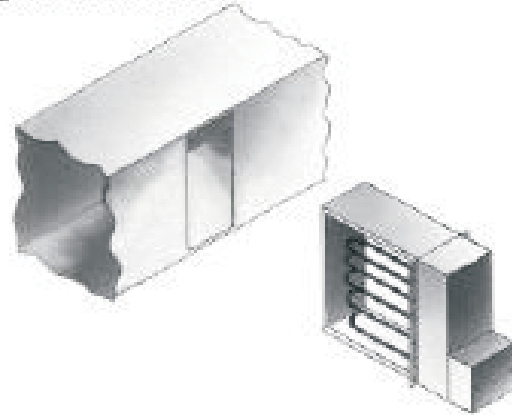
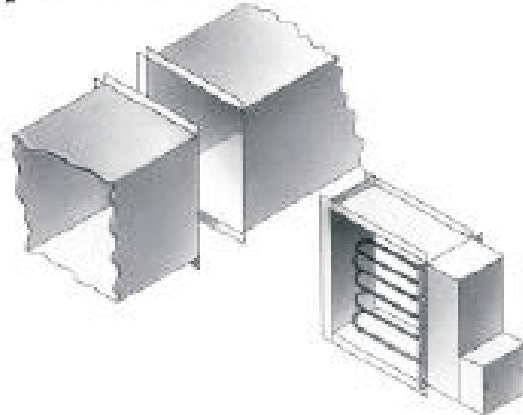

Figure 4 - FLANGE TYPE



Air frames are fabricated from 16 gauge satin coat steel. Specially constructed stainless steel frames are also available.

A unique modular construction using stock frame components is employed using vertical and horizontal dimensional increments of two inches, ensuring rapid delivery.

Браќа Минџови бр.18, Стара Царица Битола. Г.Т.Ц.Бунјаковец Скопје
Тел/Факс: 047/203-900; 203-330; 070/237-108
Тел/Факс: 02/329 8 130; 070/237 198

www.elektroluks.com.mk, www.electrolux.com.mk, electrolux@mt.net.mk

Electroluks is registered trademark of Elektroluks companies in Macedonia and other countries



Електролукс Electrolux Bitola

Ovoј crtez e сопственост на Electroflux-Bitola. Bez negovo писмено одобрување истиот несмее да се препишува, умножува нити копира без согласност од Electroflux во спротивно се сносат последици во смисла на членовите 163 и 164 од кривичниот закон R.M. (повреда на авторско право)

Other Electrical Heating Equipment

Model EPH - Control Panel and Pump House Heater

Convection type heater for enclosures less than 100 square feet of surface area. The heating capacity range is 50 Watts to 600 Watts.

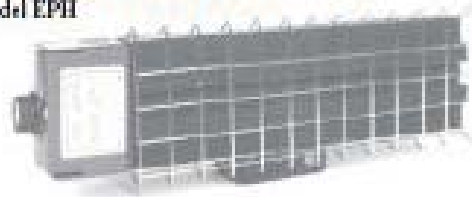

Model EXCB

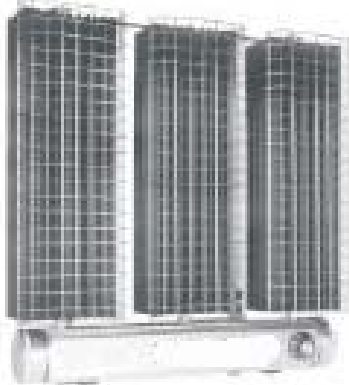

Models EXCA and EXCB - Explosion Resistant Convection Heater.

The heaters are designed for space heating where potentially explosive substances are or may be present.

Typical applications include:

- control cabinets and small enclosures
- storage rooms for paints and cleaners
- grain elevators
- flour mills
- spray booths
- gas plants
- pump houses
- service stations
- oil platforms
- cleaning and dyeing plants

The heating capacity range is 50 Watts to 5 kW

EPW Series Packaged Circulation Water Heaters

EPW Series packaged water heaters are designed for installation in circulating loops where space is limited.

The basic unit can be equipped with various control packages which will allow the heater to function:

- a) as a commercial swimming pool heater, or
- b) as a side arm domestic water heater or commercial dishwasher booster heater, or
- c) as a commercial hot water furnace for comfort or process heating.

The heating capacity range is 6 kW to 60 kW.



EPW Series

Model EVSB - Packaged Steam Boilers

Electric resistance boilers find broad application in commercial and industrial heating systems. Their main advantages over fuel fired boilers are that they are clean and odorless with no requirement for venting and that they are easy to operate.

The heating capacity range is 9 kW to 270 kW.



Model EVSB