



Spare parts suitable for:
FABAR



G.E.V. Großküchen-Ersatzteil-Vertrieb GmbH
Robert-Koch-Straße 3a
82152 Planegg/Munich
Germany

Phone: +49 (0)89 745572-0
Fax: +49 (0)89 745572-83
order@gev-online.com
www.gev-online.com

Member of the  **GEV GROUP**



Wash and rinse systems

Page 4



Various and air traps

Page 5



Drain and filter systems

Page 6



Door and hood components

Page 6



Electrical components

Page 7



Heating elements and boilers

Page 8



Pumps and components

Page 8

F Wash and rinse systems

Suitable for Fabar

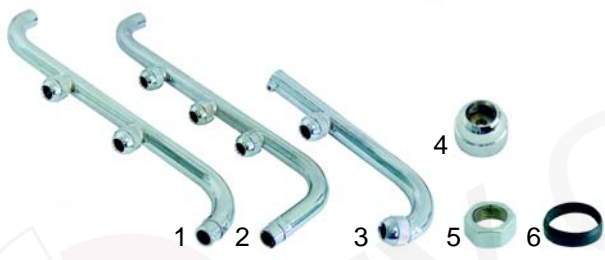

Item	Order	Description	Model	OEM
1	503047	wash pipe lower	T34I/ T34S	05063
2	503048	wash pipe upper	T39I/ T39S	05063B
3	503049	wash pipe on the side		05064
4	503046	wash jet	T34I/ T34S, T39I/ T39S	05061
5	503060	union nut 1"		06091
6	503061	gasket		06092



Item	Order	Description	Model	OEM
1	503080	rinse arm	T34I/ T34S	09127
2	503081	rinse arm	T39I/ T39S	09127B
3	503082	rinse jet	T34I/ T34S, T39I/ T39S	09128

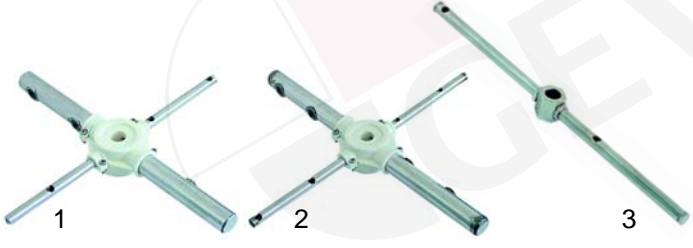

Item	Order	Description	Model	OEM
1	503056	wash and rinse arm	Q35S	06087CI
2	503055	wash and rinse arm	Q40S	06087I
3	503050	rinse arm/ upper	Q35S/ Q40S	06083

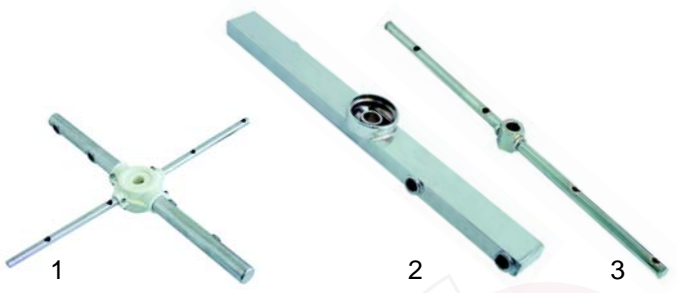

Item	Order	Description	Model	OEM
1	503069	wash and rinse arm		07098BI
2	503075	wash arm/ lower	Q45F/ Q45FM	07103B
3	503072	rinse arm		07101B

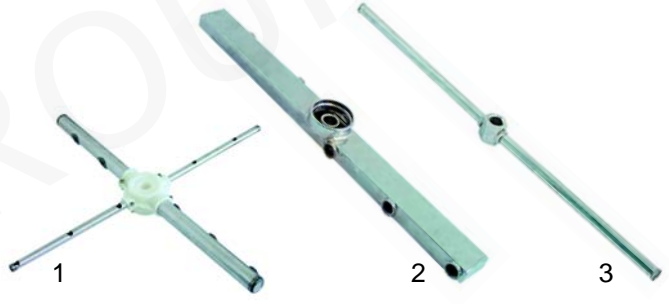

Item	Order	Description	Model	OEM
1	503068	wash and rinse arm	Q50F/ Q50FA,	07098I
2	503074	wash arm/ lower	Q50FM,	07103
3	503071	rinse arm	Q50FAM	07101



Item	Order	Description	Model	OEM
1	503057	rinse jet	Q35S, Q40S,	06088B
2	503111	O-ring/ rinse jet	Q45F, Q45FM,	15215
3	503073	wash jet	Q50F, Q50FA, Q50FM, Q50FAM	07102

Turning basket system



Item	Order	Description	Model	OEM
1	503033	basket turn table		04039
2	503034	basket turn table bearing, compl.		04040
3	503038	nut	T34I,	04043
4	503039	thumbscrew	T34S,	04044
5	503040	bearing nut	T39I,	04045
6	503041	O-ring	T39S	04046
7	503042	nut, 3/8"		04047
8	503044	door stay		04048
9	503045	nut, 1/4"		04049



Item	Order	Description	Model	OEM
1	503041	gasket, 3/8"		04046
2	503042	nut, 3/8"	T34I,	04047
3	503084	T-fitting	T34S,	09129B
4	503086	gasket, 1/4"	T39T,	09130
5	520702	screw cap, 1/4"	T39S	09131



Item	Order	Description	Model	OEM
1	503120	rinse arm holder, upper		CUF3812
2	503042	nut, 3/8"		04047
3	503041	O-ring	Q35S,	04046
4	503053	nipple, 3/8", A/ M10I	Q40S	06085R
5	503051	bearing bush		06084
6	503052	rinse arm spindle		06085



Item	Order	Description	Model	OEM
1	503059	wash arm support		06090
2	503054	screw	Q35S, Q40S	06086
3	503062	bearing bush		06104
4	503058	wash arm shaft		06089

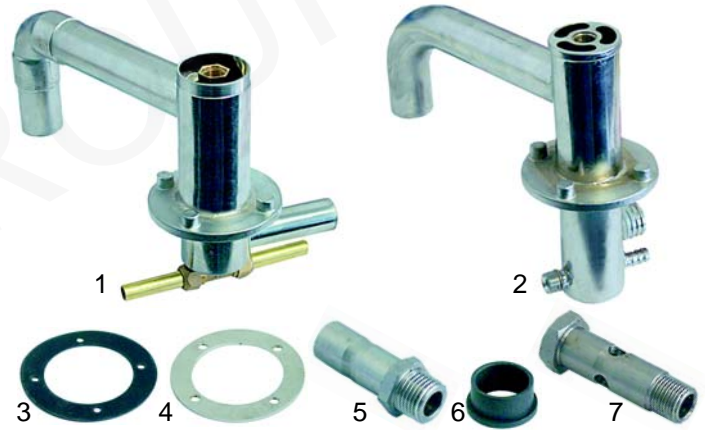

Item	Order	Description	Model	OEM
1	503077	wash arm support, lower	Q45F/ Q45FM	07105B
2	503076	wash arm support, lower	Q50F/ Q50FA, Q50FM, Q50FAM	07105A
3	503112	gasket	Q45F/ Q45FM,	16241
4	503067	flange	Q50F/ Q50FA, Q50FM, Q50FAM	07096C
5	503070	wash arm shaft		07099
6	503062	bearing bush		06104
7	503052	banjo bolt		06085



Item	Order	Description	Model	OEM
1	503060	union nut		06091
2	503061	gasket, conical		06092
3	503020	O-ring - pump (pressure)		03030
4	503041	gasket, 3/8"	Q35S,	04046
5	503042	nut, 3/8"	Q40S	04047
6	503085	T-fitting		09129Q
7	503091	T-fitting, curved		09149I
8	503086	gasket, 1/4"		09130
9	520702	screw cap, 1/4"		09131

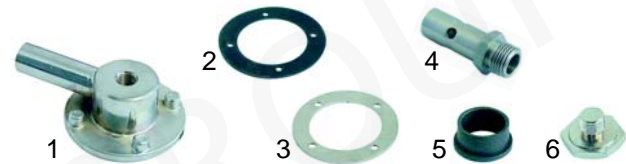

Item	Order	Description	Model	OEM
1	503066	wash arm support, upper		07096C
2	503112	gasket	Q45F, Q45FM, Q50F, Q50FA,	16241
3	503067	flange	Q50FM, Q50FAM	07096C
4	503058	wash arm shaft		06089
5	503062	bearing bush		06104
6	503054	screw		06086

Air traps



Item	Order	Description	Model	OEM
1	503113	air trap		21002
2	503119	gasket		21005
3	503115	nut	T34I/ T34S, T39I/ T39S,	21003A
4	503118	gasket	Q35S/ Q40S,	21004
5	503117	hose connector	Q45F/ Q50F, Q50FA	21002C
6	503116	union nut		21003B
7	503114	hose, 4 x 1,5		21002A



Item	Order	Description	Model	OEM
1	503078	union nut 1"		07106
2	503138	gasket, conical	Q45F/ Q45FM, Q50F/ Q50FA,	07107
3	503109	O-ring - pump (pressure)	Q50FM,	11165
4	503083	T-fitting	Q50FAM	09129
5	503086	gasket, 1/4"		09130
6	520702	screw cap, 1/4"		09131

F Drain and filter systems

Over flow system

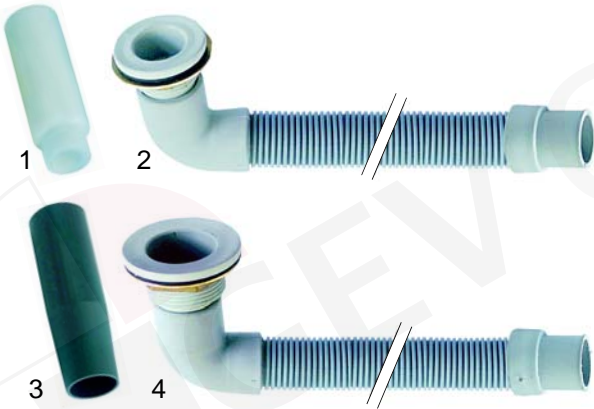

Item	Order	Description	Model	OEM
1	503017	drain plug	T34I/ T34S	03028/A/F
2	503023	outflow, 1", compl.	T39I/ T39S, Q35S/ Q40S	030310
3	503016	drain plug	Q45F/ Q45FM	03028B
4	503026	outflow, 1 1/4", compl.	Q50F/ Q50FA, Q50FM/ Q50FAM	030320

Pumps-filter (air inlet system)

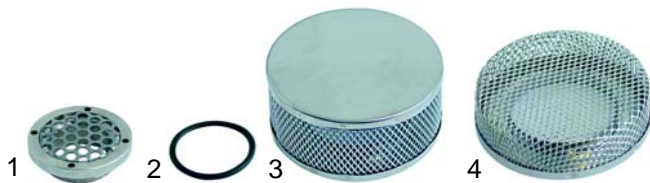

Item	Order	Description	Model	OEM
1	503108	screw + filter	T34I/ T34S, T39I/ T39S	11164
2	503109	O-ring, 1 1/4"	Q35S/ Q40S,	11165
3	503030	filter	T34I/ T34S, T39I/ T39S	03035
4	503031	filter	Q35S/ Q40S	030352



Item	Order	Description	Model	OEM
1	503110	nut with filter	Q45F/ Q45FM, Q50F/ Q50FA, Q50FM/ Q50FAM	12175
2	503079	O-ring, 1 1/2"		08123
3	503032	filter		03035A

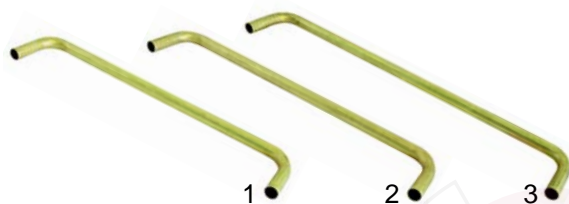

Item	Order	Description	Model	OEM
1	503063	rising pipe	Q45F/ Q45FM	07095B
2	503064	rising pipe	Q50F/ Q50FM	07095C
3	503065	rising pipe	Q50FA/ Q50FAM	07095D



Item	Order	Description	Model	OEM
1	503107	angle piece	T34I/ T34S, Q35	10165B
2	503090	connection (boiler/ solenoid valve)	T34I/ T34S, Q35S	09149
2	503092	connection (boiler/ solenoid valve)	T39I/ T39S, Q40S	09149L
2	503137	connection (boiler/ solenoid valve)	T45F/ T45FM, T50F/ T50FM, T50FA/ T50FAM	09149E



Item	Order	Description	Model	OEM
1	503098	heating pipe	T34I/ T34S,	10156
2	503041	O-ring, 3/8"	T39I/ T39S, Q35S/ Q40S	04046
3	503042	nut, 3/8"		04047
4	503099	heating pipe	Q45F/ Q45FM,	10156E
5	503010	O-ring, 1/2"	Q50F/ Q50FM, Q50FA/ Q50FAM	02018
6	503043	nut, 1/2"		04047B

Door and hood components



Item	Order	Description	Model	OEM
1	503009	door handle		02017B
2	503010	gasket	T34I/ T34S, T39I/ T39S,	02018
3	503012	nut, 1/2"	Q35S/ Q40S,	02019
4	503013	fixing elbow	Q45F/ Q45FM,	02020
5	503121	star washer	Q50F/ Q50FM,	R0008A
6	503122	screw, M8 x 10	Q50FA/ Q50FAM	V810E
7	503093	watertap compl.		101010

Electrical components



Item	Order	Description	Model	OEM
1	503001	micro switch kit	ALLE	01035K
2	345363	micro switch		01035
3	503104	thermostat pocket	T34I/ T34S, Q35	10158



Item	Order	Description	Model	OEM
1	360210	timer 4° water filling	Q45FM	130191
2	360211	timer 120°	Q50FM	130190
3	110340	knob	Q50FAM	13188



Item	Order	Description	Model	OEM
1	370239	solenoid valve	T34I/ T34S,	09132
2	503088	nipple, 1/2" - 3/4"	T39I/ T39S,	09133
3	503089	gasket, 3/4"	Q35S/ Q40S,	09133B
4	371071	solenoid coil, 230V	Q45F/ Q45FM, Q50F/ Q50FM, Q50FA/ Q50FAM	09139



Item	Order	Description	Model	OEM
1	541162	pressure switch 80/50	T34I/ T34S/ T39I/	21001A
2	365045	interference suppression filters	T39S/ Q35S/ Q40S/ Q45F/ Q50F/ Q50FA	13300

Switches

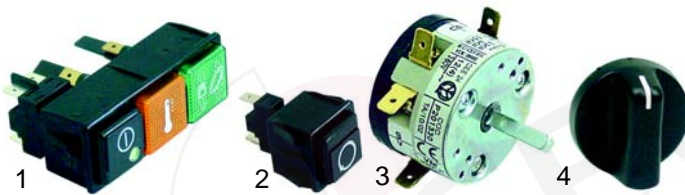

Item	Order	Description	Model	OEM
1	345558	push button 3-fold	T34I/ T34S	13403
2	345557	push button 1-fold	T39I/ T39S	13401
3	345559	switch 2-pole	Q35S/ Q40S/ Q45F/ Q50F/ Q50FA	13186
4	110340	knob	Q50FAM	13188

Timers

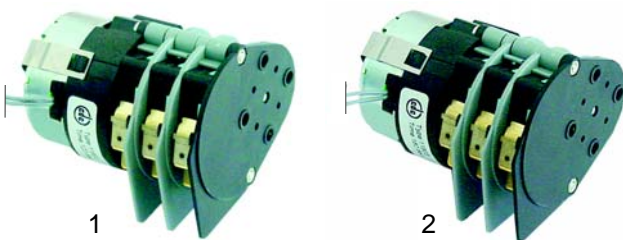

Item	Order	Description	Model	OEM
1	360212	timer 120°	T34S / T39S Q35S/ Q40S	13190F
2	360213	timer 180°	Q45F/ Q50F/ Q50FA	13190M

Thermostats

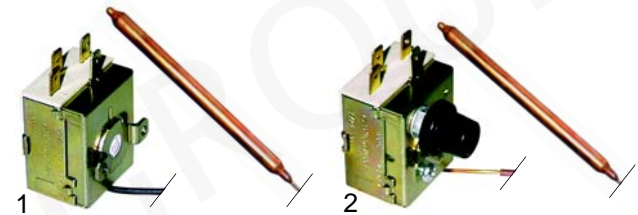

Item	Order	Description	Model	OEM
1	390421	thermostat 0-90°	T34I/ T34S/ T39I/ T39S/ Q35S/ Q40S/ Q45F/ Q50F/	14197
2	390023	safety thermostat 110 °C	Q50FA/ Q45FM/ Q50FM/ Q50FAM	141197A

Relays/contactors

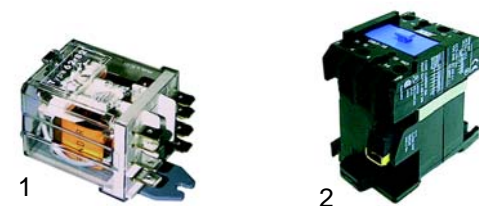

Item	Order	Description	Model	OEM
1	380139	relay	T39S/ Q40S/ Q45F/ Q50F/ Q50FA	13192C
2	380203	contactor	Q45F/ Q45FM/ Q50F/ Q50FM/ Q50FA/ Q50FAM	13192

Signal lamps



Item	Order	Description	Model	OEM
1	359027	signal lamp green	Q45 FM/ Q50FM/	13183B
2	359048	signal lamp yellow	Q50FAM	13183

F Connector blocks

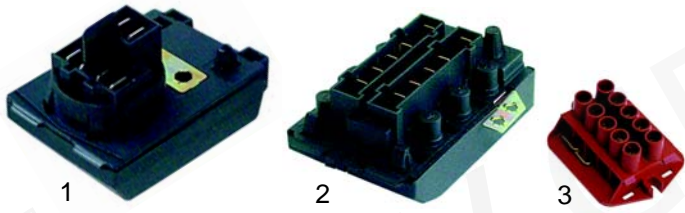

Item	Order	Description	Model	OEM
1	550488	connector block 3-pole	T34 I/ T34S/ T39 I/ T39S/ Q35S/ Q40S/ Q45FM/ Q50FM/ Q50FAM	01213
2	550489	connector block 5-pole	Q45F/ Q50F/ Q50FAM	01214
3	550034	connector block 5-pole	all	01212

Heating elements and boilers



Item	Order	Description	Model	OEM
1	415160	heating element, 1000W/230V	T34I/ T34S/ Q35S	10163
2	415161	heating element, 2700W	T39I/ T39S/ Q40S/ Q45F/ Q45FM	10162
3	415162	heating element, 5000W	Q50F/ Q50FM/ Q50FA/ Q50FAM	10162B

Pumps and components



Item	Order	Description	Model	OEM
1	500334	pump 0,55 HP	T34I/T34S/ T39I/ T39S/ Q35S/ Q40S	111130
2	500336	pump 0,75 HP	Q45F/ Q45FM	121220
3	500335	pump 1,0 HP	Q50F/ Q50FM/ Q50FA/ Q50FAM	121230



Item	Order	Description	Model	OEM
1	503106	gasket heating element	T34I/ T34S/Q35S	10161
2	503105	gasket heating element	T39I/ T39S/ Q40S/ Q45F/ Q45FM/ Q50F/ Q50FM/ Q50FA/ Q50FAM	10160

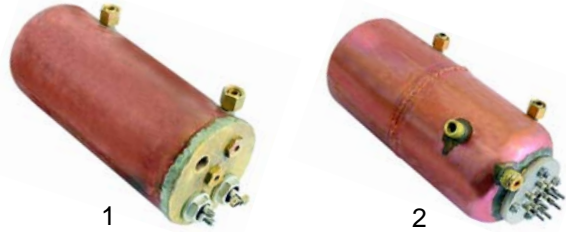

Item	Order	Description	Model	OEM
1	503100	boiler compl.	T34I/ T34S/ Q35S	10157
2	503101	boiler compl.	T39I/ T39S/ Q40S	10157B



Item	Order	Description	Model	OEM
1	503102	boiler compl.	Q45F/ Q45FM	10157C
2	503103	boiler compl.	Q50F/ Q50FM/ Q50FA/ Q50FAM	10157 I



1	2	3	4	5	6	7	8	9	10						
Pumps		Pump cover		Impellor		Mechanical seal		Gegenring		Housing gasket		Pump body		Capacitor	
Order	OEM	Order	OEM	Order	OEM	Order	OEM	Order	OEM	Order	OEM	Order	OEM	Order	OEM
500334	111130	503126	11166	503128	11169BP	503129	11170	503130	11171	503125	11167	503131	11173	365015	11174
500336	121220	503132	12177	503133	12179	503129	11170	503130	11171	503125	11167	503136	12182	365020	11174B
500335	121230	503132	12177	503134	12179A	503129	11170	503130	11171	503125	11167	503136	12182	365019	11174C

