

Operating manual

Direct print module
DPM III xi series

June 2010



Copyright by Carl Valentin GmbH / 7967005A0610

Information on the scope of delivery, appearance, performance, dimensions and weight reflect our knowledge at the time of printing.

We reserve the rights to make modifications.

All rights, including those regarding the translation, are reserved.

No part of this document may be reproduced in any form (print, photocopy or any other method) or edited, copied or distributed electronically without written permission from Carl Valentin GmbH.

Carl Valentin direct print modules comply with the following safety guidelines:

CE EG Low-Voltage Directive (2006/95/EG)
EG Electromagnetic Compatibility Directive (89/336/EWG)



Carl Valentin GmbH

Postfach 3744

D-78026 Villingen-Schwenningen

Neckarstraße 78-82+94

D-78056 Villingen-Schwenningen

Phone: +49 7720 9712-0

Fax: +49 7720 9712-9901

E-mail: info@valentin-carl.de

www.valentin-carl.de

Table of contents

Table of contents	3
1 Important notes	5
1.1 Intended use	5
1.2 Environmentally-friendly disposal.....	6
1.3 Figures.....	6
1.4 Print principle.....	8
2 Safety notes	9
2.1 Warnings	9
2.2 Operating conditions.....	10
3 Technical data	15
3.1 Control inputs and outputs (version I)	16
3.2 Control inputs and outputs (version II)	20
3.3 Plug & Play	24
4 Installation and Initiation	25
4.1 Installation of print mechanics at machines	26
4.2 Connection of pneumatic power supply	27
4.3 Adjustment of pressure power.....	28
4.4 Connecting the direct print module.....	29
4.5 Before initial operation.....	29
4.6 Print control	30
4.7 Initiation	30
4.8 Loading transfer ribbon	31
5 Foil keyboard	33
5.1 Keyboard assignment (standard)	33
5.2 Keyboard assignment (text entry/customized)	34
6 Function menu	37
6.1 Menu structure.....	37
6.2 Print settings.....	39
6.3 Machine parameters.....	40
6.4 Layout settings	44
6.5 Ribbon save.....	45
6.6 Device settings	46
6.7 I/O parameters.....	48
6.8 Network (option)	49
6.9 Remote console.....	49
6.10 Interface.....	50
6.11 Emulation.....	51
6.12 Date & time	52
6.13 Service functions	53
6.14 Main menu	55
7 Compact Flash card	57
8 Maintenance and cleaning	61
8.1 Cleaning the printhead	61
8.2 Replacing printhead	61
8.3 Transfer ribbon tension	63
8.4 Angle adjustment.....	64
8.5 Zero point adjustment.....	65
8.6 Print quality optimisation	66
8.7 Cycle optimisation	67

9	Signal diagrams	69
9.1	Mode 1 (single item processing)	69
9.2	Mode 2 (continuous mode).....	70
9.3	Mode 4 (continuous mode).....	71
9.4	Mode 8 (single item processing)	72
10	Error correction	73
11	Additional information	83
11.1	Column printing	83
11.2	Password	84
11.3	Hotstart	86
12	Index	89

1 Important notes

The direct print module is equipped with 6 vector, 6 bitmap and 6 proportional fonts. It is possible to print inverse, in italic format or 90 degrees turned fonts.

The handling of our durable print module is easy and comfortable. The settings are made with the keys of the foil keyboard. At each time the two-line display shows the current status.

An enormously high print quality is obtained by most modern printhead technology.

By a new-developed electronics a maximum print speed up to 450 mm/s can be achieved.

Time-saving update of the design software is possible by interface.

As default, the print module is equipped with a parallel, serial and USB interface. The device automatically recognizes by which interface it is controlled.

Thanks to the large number of options the print module can be adapted to each task.

1.1 Intended use

The direct print module is a state-of-the-art device which complies with the recognized safety-related rules and regulations. Despite this, a danger to life and limb of the user or third parties could arise and the direct print module or other property could be damaged while operating the device.

The direct print module may only be used while in proper working order and for the intended purpose. Users must be safe, aware of potential dangers and must comply with the operating instructions. Faults, in particular those which affect safety, must be remedied immediately.

The direct print module is solely intended to print suitable media which have been approved by the manufacturer. Any other or additional use is not intended. The manufacturer/supplier is not liable for damage resulting from misuse. Any misuse is at your own risk.

Intended used includes heeding the operating manual, including the maintenance recommendations/regulations specified by the manufacturer.

1.2 Environmentally-friendly disposal

Manufacturers of B2B equipments are obliged to take-back and dispose old equipment which was manufactured after 13 August 2005. In principle, these old equipments may not be delivered to communal collecting points. They may only be organised used and disposed by the manufacturer. Valentin products accordingly labelled can therefore in future be returned to Carl Valentin GmbH.

Thereupon old equipment is professionally disposed.

Thereby Carl Valentin GmbH observes all obligations in the context of old equipment disposal in time and makes therewith the smooth selling of products furthermore possible. Please understand that we can only take-back equipment that is send free of carriage charges.

Further information is available from WEEE directive or our web site.

1.3 Figures

Print mechanics

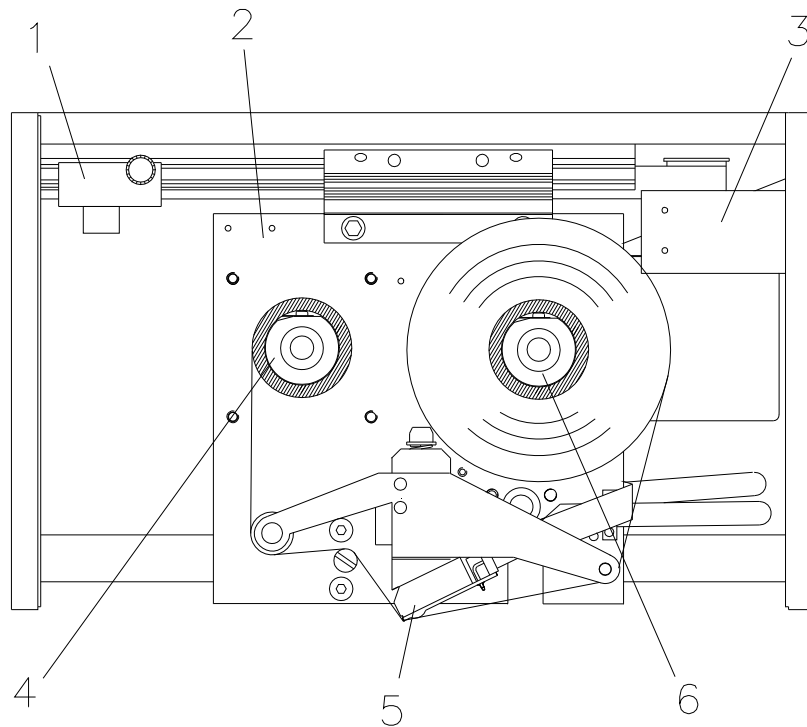

Figure 1

- 1 = Zero point adjustment
- 2 = Printing carriage
- 3 = End position control
- 4 = Ribbon rewinding unit
- 5 = Printhead
- 6 = Ribbon unwinding unit

Connector assignment of control unit

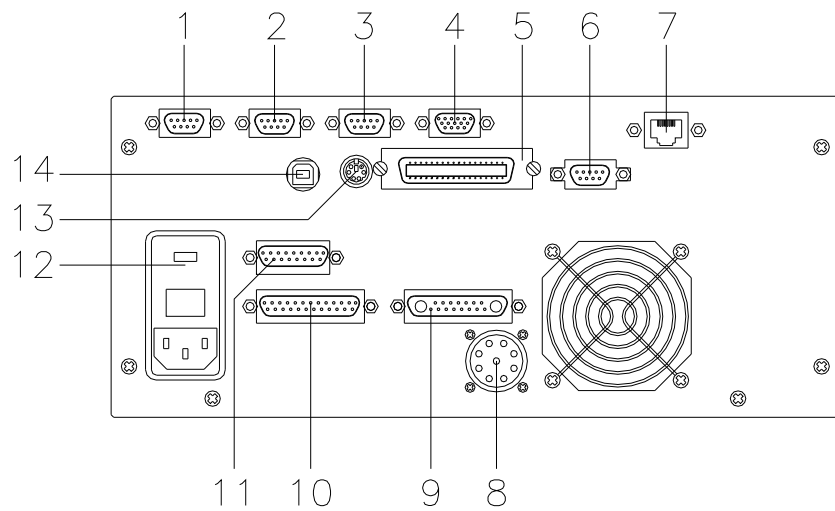

Figure 2

- | | | |
|------|---------------------------------|-------------------------|
| 1 = | External output 1-4 (Output I) | |
| 2 = | External input 1-4 (Input I) | |
| 3 = | External output 5-8 (Output II) | |
| 4 = | Version I | Version II |
| | SUB-D plug 9-pin | SUB-D plug 15-pin |
| | External input 5-8 | External bushing I/O-24 |
| | see chapter 3.1 | see chapter 3.2 |
| 5 = | Centronics interface | |
| 6 = | RS-232 interface | |
| 7 = | Ethernet interface (option) | |
| 8 = | Connecting cable power | |
| 9 = | Connecting cable motor | |
| 10 = | Connecting cable signal | |
| 11 = | Connecting cable sensors | |
| 12 = | Power supply | |
| 13 = | PS/2 keyboard connection | |
| 14 = | USB interface | |

1.4 Print principle

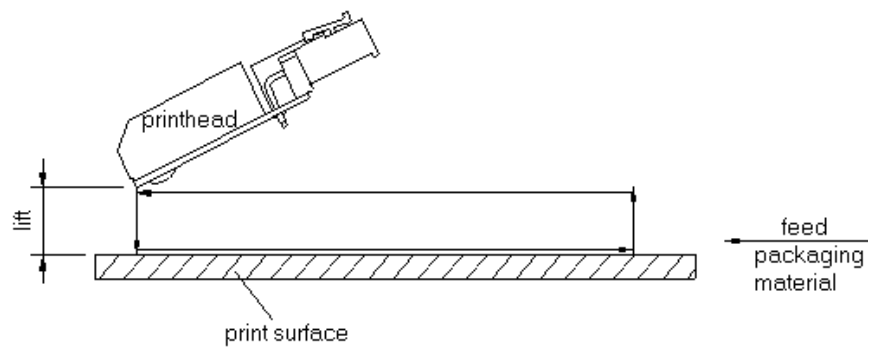

Figure 3

After starting a print order the printhead moves against the print medium. Afterwards the printing carriage moves corresponding to the set or transferred layout length linear over the material which is to be printed. After the print procedure the printhead again lifts up and the printing carriage moves again to the starting position.

2 Safety notes

The direct print module is designed for power supply systems from 230V. Connect the direct print module only to electrical outlets with a ground contact.

Couple the direct print module to devices using extra low voltage only. Before making or undoing connections, switch off all devices involved (computer, printer, accessories etc.).

Operate the direct print module in a dry environment only and do not get it wet (sprayed water, mist etc.).

If the direct print module is operated with the cover open, ensure that clothing, hair, jewellery and similar personal items do not contact the exposed rotating parts.

The print unit can get hot during printing. Do not touch the printhead during operation. Cool down the print unit before changing material, removal or adjustment.

Carry out only the actions described in these operating instructions. Other tasks may only be performed by trained personnel or service technicians.

2.1 Warnings

Warnings are presented with three signal words for the different levels of danger.

DANGER identifies an extraordinarily great and immediate danger which could lead to serious injury or even death.

WARNING identifies a possible danger would could lead to serious bodily injury or even death if sufficient precautions are not taken.

CAUTION indicates a potentially dangerous situation which could lead to moderate or light bodily injury or damage to property.

2.2 Operating conditions

Before initial operation and during operation these operating conditions have to be observed to guarantee safe and interference-free service of our devices.

Therefore please carefully read these operating conditions.

Shipment and storage of our devices are only allowed in original packing.

Installation and initial operation of direct print module is only allowed if operating conditions were fulfilled.

Initial operation, programming, operation, cleaning and service of our direct print modules are only recommended after careful study of our manuals.

Operation of direct print module is only allowed by especially trained persons.



Perform trainings regularly.

These indications are also valid for someone else's equipment supplied by us.

Only use original spare and exchange parts.

Instructions for lithium battery

CPU of direct print module is equipped with a lithium battery (type CR 2032) for which the battery regulation is to apply. This regulation plans that unloaded batteries have to be given to used battery collecting containers of trade and public carries. In case that batteries were not completely discharged you have to make arrangements for short-circuits. At a shutdown of direct print module the battery has to be disposed in either case separately from direct print module.



DANGER!

⇒ Danger of life by explosion!

Use non-conducting tools.

Conditions for installation place

The installation place of direct print module should be even, free of vibration and currents of air are to be avoided.

The direct print modules have to be installed to ensure optimal operation and servicing.

Installation of power supply

The installation of the power supply to connect our direct print modules has to be effected according to the international rules and regulations, especially the recommendations of one of the three following commissions:

- International Electronic Commission (IEC)
- European Committee for Electro technical Standardisation (CENELEC)
- Verband Deutscher Elektrotechniker (VDE)

Our direct print modules are constructed according to VDE and have to be connected to a grounded conductor. The power supply has to be equipped with a grounded conductor to eliminate internal interfering voltage.

Technical data of power supply

Power line voltage and power line frequency: See type plate
 Allow. tolerance of power line voltage: +6% to -10% of nominal value
 Allow. tolerance of power line frequency: +2% to -2% of nominal value
 Allowable distortion factor of power line voltage: $\leq 5\%$

Anti-Interference measures:

In case your net is infected (e.g. by using thyristor controlled machines) anti-interference measures have to be taken. You can use one of the following possibilities:

- Provide separate power supply to our direct print modules.
- In case of problems please connect capacity-decoupled isolation transformer or similar interference suppressor in front of our direct print modules.

Stray radiation and immunity from disturbance

Emitted interference according to EN 61000-6-4: 08-2002

- Interference voltage to wires according to EN 55022: 09-2003
- Interference field power according to EN 55022: 09-2003
- System perturbation according to EN 61000-3-2: 09-2005
- Flicker according to EN 61000-3-3: 05-2002

Immunity to interference according to EN 61000-6-2: 03-2006

- Stray radiation against discharge of static electricity according to EN 61000-4-2: 12-2001
- Electromagnetic fields according to EN 61000-4-3: 11-2003
- Fast transient burst according to EN 61000-4-4: 07-2005
- Surge according to EN 61000-4-5: 12-2001
- High-frequency tension according to EN 61000-4-6: 12-2001
- Voltage interruption and voltage drop according to EN 61000-4-11: 02-2005



This is a machine of type A. This machine can cause interferences in residential areas; in this case it can be required from operator to accomplish appropriate measures and be responsible for it.

Connecting lines to external machines

All connecting lines have to be guided in shielded lines. Shielding has to be connected on both sides to the corner shell.

It is not allowed to guide lines parallel to power lines. If a parallel guiding cannot be avoided a distance of at least 0.5 m has to be observed.

Temperature of lines between: -15 to +80 °C.

It is only allowed to connect devices which fulfil the request 'Safety Extra Low Voltage' (SELV). These are generally devices which are checked corresponding to EN 60950.

Installation of data lines

The data cables must be completely protected and provide with metal or metallised connector housings. Shielded cables and connectors are necessary, in order to avoid radiant emittance and receipt of electrical disturbances.

Allowable lines

Shielded line: 4 x 2 x 0,14 mm² (4 x 2 x AWG 26)
 6 x 2 x 0,14 mm² (6 x 2 x AWG 26)
 12 x 2 x 0,14 mm² (12 x 2 x AWG 26)

Maximum line length: interface V 24 (RS-232C) - 3 m at max. 19200 bds
 Centronics - 3 m
 USB - 5 m
 Ethernet - 100 m

Air convection

To avoid inadmissible heating, free air convection has to be ensured.

Limit values

Protection according IP: 20

Ambient temperature °C (operation): Min. +5 Max. +40

Ambient temperature °C (storage): Min. -20 Max. +60

Relative air humidity % (operation): Max. 80

Relative air humidity % (storage): Max. 80
(bedewing of direct print modules not allowed)

Guarantee

We do not take any responsibility for damage caused by:

- Ignoring our operating conditions and operating manual.
- Incorrect electric installation of environment.
- Building alterations of our direct print modules.
- Incorrect programming and operation.
- Not performed data protection.
- Using of not original spare parts and accessories.
- Natural wear and tear.

When (re)installing or programming our direct print modules please control the new settings by test running and test printing. Herewith you avoid faulty results, reports and evaluation.

Only specially trained staff is allowed to operate the direct print modules.

Control the correct handling of our products and repeat training.

We do not guarantee that all features described in this manual exist in all models. Caused by our efforts to continue further development and improvement, technical data might change without notice.

By further developments or regulations of the country illustrations and examples shown in the manual can be different from the delivered model.

Please pay attention to the information about admissible print media and the notes to the direct print module maintenance, in order to avoid damages or premature wear.

We endeavoured to write this manual in an understandable form to give you as much as possible information. If you have any queries or if you discover errors, please inform us to give us the possibility to correct and improve our manual.

3 Technical data

	DPM III xi53	DPM III xi107	DPM III xi128
Print width	max. 53,3 mm	max. 106,6 mm	max. 128 mm
Print length	60 mm, 140 mm, 240 mm, 340 mm, 447 mm, 570 mm, 630 mm		
Resolution	300 dpi		
Print speed	50-450 mm/s*	50-450 mm/s*	50-400 mm/s*
Back speed	50-500 mm/s*	50-500 mm/s*	50-400 mm/s*
Printhead	Corner Type		
Built-in fonts	vector fonts: 6 free scaleable BITSTREAM® fonts bitmap fonts: 6 proportional fonts: 6 font height: min. 1 mm - max. 99 mm		
Bar codes 1D bar codes	CODABAR, Code 128, Code 2/5 interleaved, Code 39, Code 39 extended, Code 93, EAN 13, EAN 8, EAN ADD ON, GS1-128 (EAN 128), Identcode, ITF 14, Leitcode, Pharmacode, PZN Code, UPC-A, UPC-E		
2D bar codes	CODABLOCK F, DataMatrix, MAXICODE, PDF 417, QR Code		
Composite bar codes	GS1 DataBar Expanded, GS1 DataBar Limited, GS1 DataBar Omnidirectional, GS1 DataBar Stacked, GS1 DataBar Stacked Omnidirectional, GS1 DataBar Truncated		
Interface	Serial: RS-232C (up to 19200 Baud) – Parallel: Centronics USB: 1.1 – Ethernet: 10/100 Base-T (option)		
Transfer ribbon	core diameter: 25,4 mm / 1" length: max. 600 m (Ø 85 mm) colour: outside/inside		
Module memory Memory card	max. 4 MB Compact Flash Card: 128 MB, 256 MB, 512 MB, 1024 MB, 1 GB, 2 GB		
Dimensions in mm (width x height x depth)			
Print mechanics	(print length + 230) x 170 x 260	(print length + 230) x 170 x 3150	(print length + 230) x x 170 x 335
Control unit	285 x 130 x 350 - connecting cable to mechanics 2,5 m		
Weight Print mechanics Electronics (incl. cable)	(depending on print width) e.g. xi53 x 60 mm = 7,3 kg / xi128 x 630 mm = 23 kg 10,5 kg		
Connection values Pneumatic connection Nominal voltage Nominal current Safety values	min. 6 bar dry and free of oil standard: 230 V / 50-60 Hz option: 115 V / 50-60 Hz 230 V / 1,5 A – 115 V / 3 A 230 V / 3,15 AT – 115 V / 6,3 A		
Operating conditions Temperature Relative humidity	5-40 °C max. 80% (non-condensing)		

Technical modifications are subject to change.

* depending on installation position

3.1 Control inputs and outputs (version I)

Plug connection - back side of control unit

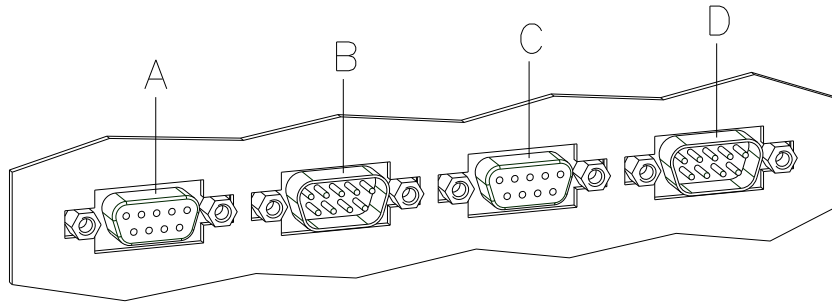

Figure 4

- A = External output 1-4 (Output I)
- B = External input 1-4 (Input I)
- C = External output 5-8 (Output II)
- D = External input 5-8 (Input II)

Control outputs

By means of the signal outputs different operating states of the print module can be queried.

The signal outputs are provided by two 9-pin SUB-D-bushings (OUTPUT I and OUTPUT II) on the back side of the control unit.

They consist of optocoupler semiconductor sections, which are connected through and/or blocked according to different operating states.

The maximum allowable current in a semiconductor section is $I_{max} = 30 \text{ mA}$.

Output I
Figure 4, A

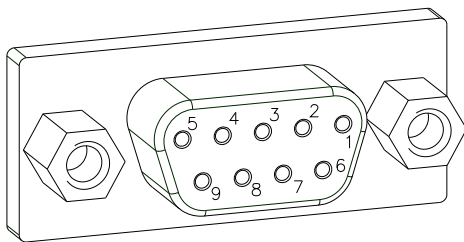

Figure 5

PIN (bushing)	Output I
	Out 1: Error message Each error status such as ribbon error is displayed.
	Out 2: Print order The print module was activated by a print order.
	Out 3: Generation The print module is filled with current layout data.
	Out 4: Layout print The content of print memory is transferred on the printable medium by means of the printhead.

Example

Connection of a lamp to a 24V relay by Out 1:

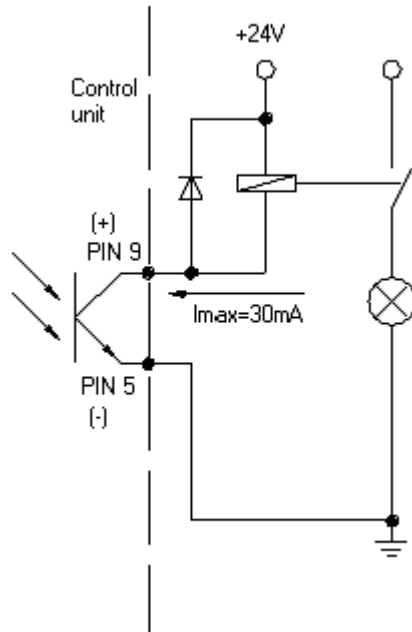

Figure 6

Output II
Figure 4, C

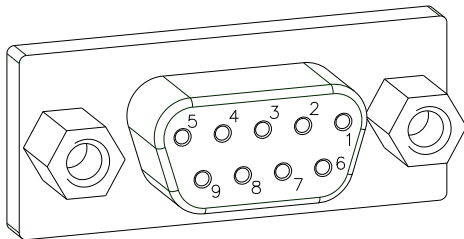

Figure 7

PIN (bushing)	Output II
<p>9 (+) 5 (-)</p>	<p>Out 5: Print-Ready signal It is indicated if the print module is ready to process a start impulse. In contrary to the print order signal, the generating time is taken into consideration.</p>
<p>8 (+) 7 (-)</p>	<p>Out 6: Printhead up The printhead has reached the upper rest position (e.g. return to zero point).</p>
<p>6 (+) 2 (-)</p>	<p>Out 7: Return to start After termination of print procedure the flexible part of the print module is moved back to the start position. After the start position was reached a new start can be released.</p>
<p>4 (+) 3 (-)</p>	<p>Out 8: Prior warning of transfer ribbon end</p>

Control inputs

By means of the control inputs it is possible to control printing. The control inputs at Input I are electroplated separated and have to be provided with an external tension source. The signal level is active "HIGH".

Input I
Figure 4, B

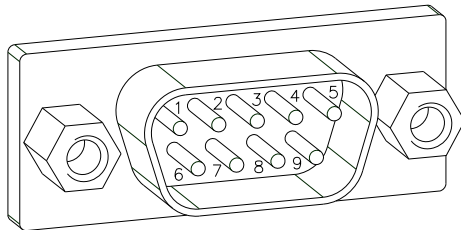

Figure 8

PIN (pin)	Input I
	In 1: Print start
	In 2: Not used
	In 3: Reset external counter
	In 4: Not used

Example

Connection of a switch with 24V voltage supply by In 1:

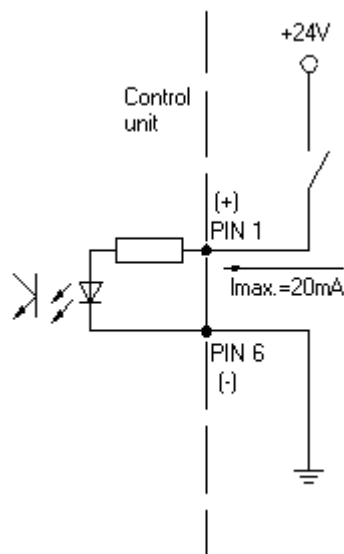

Figure 9

Input II
Figure 4, D

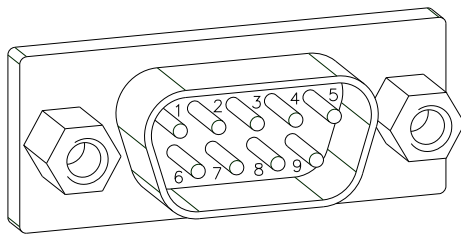

Figure 10

PIN (pin)	Input II
	In 5: Not used
	In 6: Not used
	In 7: Not used
	In 8: Not used

3.2 Control inputs and outputs (version II)

Plug connection - back side of control unit

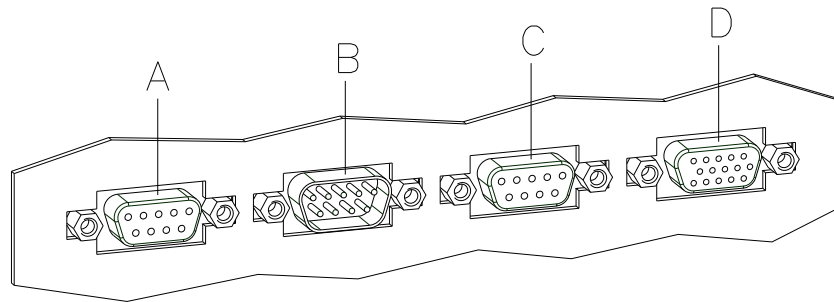

Figure 11

- A = External output 1-4 (Output I)
- B = External input 1-4 (Input I)
- C = External output 5-8 (Output II)
- D = External bushing 15pin (I/O-24)

Control outputs

By means of the signal outputs different operating states of the print module can be queried.

The signal outputs are provided by two 9-pin SUB-D-bushings (OUTPUT I and OUTPUT II) on the back side of the control unit.

They consist of optocoupler semiconductor sections, which are connected through and/or blocked according to different operating states.

The maximum allowable current in a semiconductor section is $I_{max} = 30 \text{ mA}$.

Output I
Figure 11, A

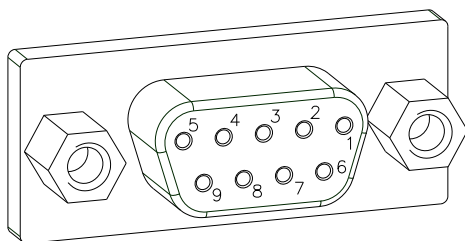

Figure 12

PIN (bushing)	Output I
	Out 1: Error message Each error status such as ribbon error is displayed.
	Out 2: Print order The print module was activated by a print order.
	Out 3: Generation The print module is filled with current layout data.
	Out 4: Layout print The content of print memory is transferred on the printable medium by means of the printhead.

Example

Connection of a lamp to a 24V relay by Out 1:

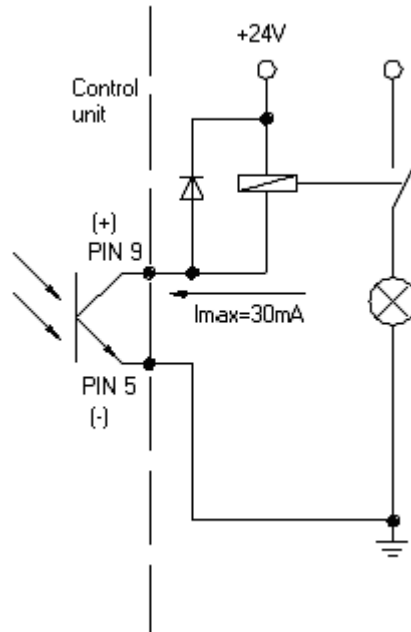

Figure 13

Output II
Figure 11, C

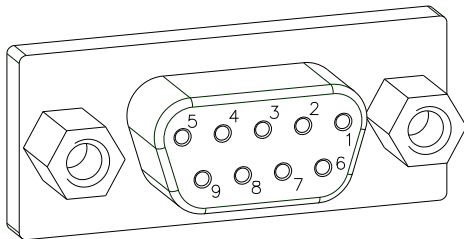

Figure 14

PIN (bushing)	Output II
<p>9 (+) 5 (-)</p>	<p>Out 5: Print-Ready signal It is indicated if the print module is ready to process a start impulse. In contrary to the print order signal, the generating time is taken into consideration.</p>
<p>8 (+) 7 (-)</p>	<p>Out 6: Printhead up The printhead has reached the upper rest position (e.g. return to zero point).</p>
<p>6 (+) 2 (-)</p>	<p>Out 7: Return to start After termination of print procedure the flexible part of the print module is moved back to the start position. After the start position was reached a new start can be released.</p>
<p>4 (+) 3 (-)</p>	<p>Out 8: Prior warning of transfer ribbon end</p>

Control inputs

By means of the control inputs it is possible to control printing. The control inputs at Input I are galvanic separated and have to be provided with an external tension source. The signal level is active "HIGH".

Input I
Figure 11, B

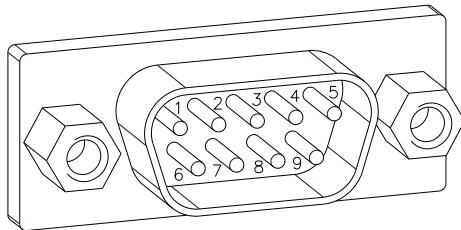

Figure 15

PIN (pin)	Input I
	In 1: Print start
	In 2: Not used
	In 3: Reset external counter
	In 4: Not used

Example

Connection of a switch with 24V voltage supply by In 1:

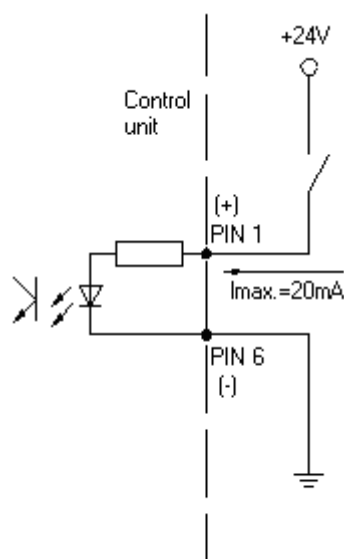

Figure 16

External bushing I/O-24
Figure 11, D

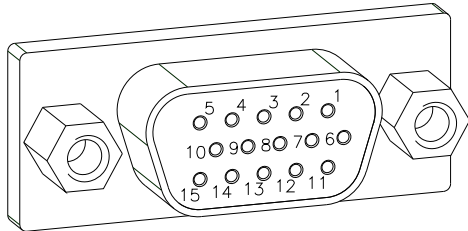
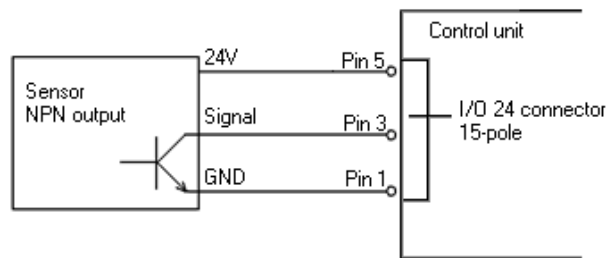

Figure 17

This input is executed as 15-pole and provides user-sided 24V/100mA.
In case of using this bushing, exists **no galvanic separation**.

PIN	Function
1, 6	Gnd
5, 10	24 V / 100 mA
3	Print start (NPN initiator)
2	Print start (PNP initiator)
4	Print start by potential-free contact
14	
7	Signal lamp 24 V / 100 mA (error)
13	

Example 1



Connection scheme for creating a start signal by a sensor with NPN output

Example 2

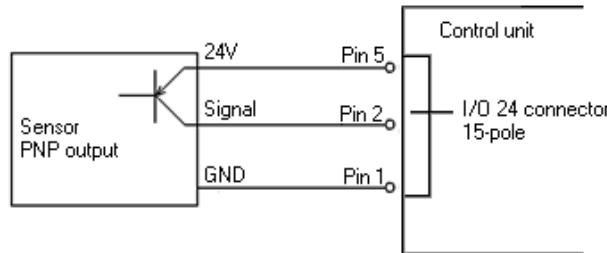

Connection scheme for creating a start signal by a sensor with PNP output

Example 3

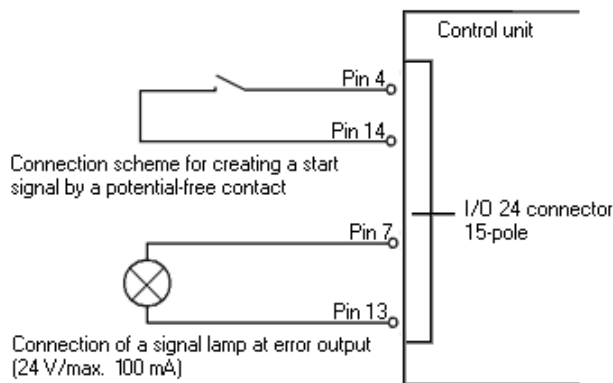

Connection scheme for creating a start signal by a potential-free contact

Connection of a signal lamp at error output (24 V/max. 100 mA)

3.3 Plug & Play

Plug & Play capable printers can be recognised automatically at parallel ports, USB-IEEE 1394- or infra-red connections but the last both are not important for our direct print modules.

The following table shows the Plug & Play capability of the different operating systems.

Port		Windows					
		95	98	Me	NT4	2000	XP
LPT	Support	✓	✓	✓	✓	✓	✓
	Recognition by	Boot procedure, device manager			x		Installation
USB	Support	x	✓	✓	s.b.	✓	✓
	Recognition by	x	Hot Plug & Play		s.b.	Hot Plug & Play	

The table above shows that USB provides the recognition during the connection in current operating mode, the so-called Hot-Plug & Play. The following possibilities exist for parallel port:

- Windows 95 / 98 / Me
Printers are recognised during the start procedure by Windows or by the search for new hardware by means of the hardware wizard.
- Windows 2000 / XP
Printers can be recognised during the start procedure by Windows or by the search for new hardware by means of the hardware wizard or, if the option 'Automatic recognition and installation of Plug & Play printers' is set in the printer installation wizard. For Windows XP the Hot Plug & Play when switching on the printer is obviously possible.



Windows NT 4.0 does not support USB devices. However, some distributors offer drivers that support USB (without Plug & Play). Such a driver which suits to our printer is offered from BSQUARE. For more information, visit their web side: www.bsquare.com or contact

BSQUARE Headquarters (USA)
888-820-4500
sales@bsquare.com

BSQUARE (Europe)
+49 (811) 600 59-0
europe@bsquare.com

4 Installation and Initiation

Unpack the direct print module

- ⇒ Lift the direct print module out of the box.
- ⇒ Check the direct print module for transport damages.
- ⇒ Check delivery for completeness.

Scope of delivery

- Print mechanics.
- Control unit.
- Power cable.
- Connection cable (printhead/motors, sensors, power).
- Mini controller.
- Manometer.
- Pneumatic tube.
- Push-on connector.
- I/O accessories (female connectors for I/O, I/O 24 cable).
- 1 transfer ribbon roll.
- Empty core, mounted on transfer ribbon rewinder.
- Cleaning foil for printhead.
- Documentation.
- CD with printer drivers.



Retain original packaging for subsequent transport.

4.1 Installation of print mechanics at machines

At the bottom of the print mechanics are two M8 threads that can be used to fasten the print mechanics.

Please observe the following conditions:

- The maximum thread engagement of the M6 threads is 14 mm.
- The print mechanics has to be installed with a distance from printhead to brake stator of 1...2,5 mm (see illustration).



A distance of 2 mm is recommended.

- The best print results can be received if the silicon of printing roll consists of a hardness of 60 - 65° Shore A (average value of roughness Ra 3.2 µm).
- The print surface has to be installed parallel to the linear movement of print unit and the focal line of printhead. Discrepancies to the focal line and cavities in the print surface of 0.2mm can lead to an inferior print quality at these positions.

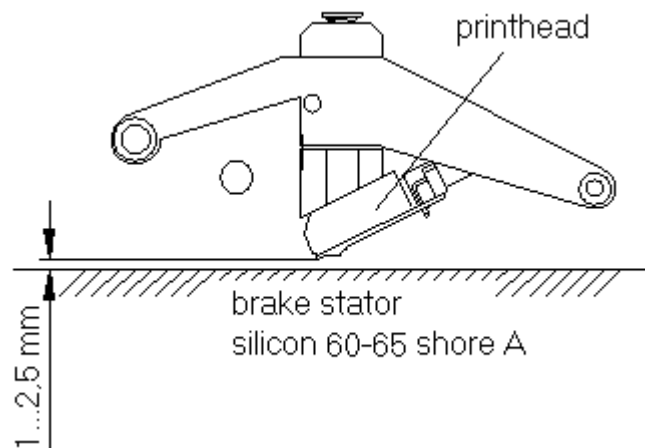

Figure 18

4.2 Connection of pneumatic power supply

The pneumatic power supply for the printhead mechanics has to be made available a minimum continuous pressure of 4 - 6 bars in front of the pressure regulator. The maximum pressure in front of the pressure regulator is 7 bars and 4 bars after the pressure regulator.



A pneumatic power supply of 4 bars is recommended.

The compressed-air has to be dry and oil free.

The supplied pressure regulator with manometer is to connect with a plastic tube \varnothing 8 mm via a plugging bolting to the pneumatic power supply. It is necessary to make a connection between the pressure regulator and the print mechanics via a plastic tube \varnothing 8 mm.

Please observe the following notes:

- Position pressure regulator as near as possible to the print mechanics.
- The pressure regulator is only to operate in the direction that is indicated on its underside. The direction shows the way of the streaming air.
- It is not allowed to bend the plastic tubes.
- Shortening of the plastic tubes has to be made with a clean right-angled cut without squashing the tube. If necessary use special tools (available in pneumatic requirements).
- Please observe a possible short length of the 8 mm plastic tubes.

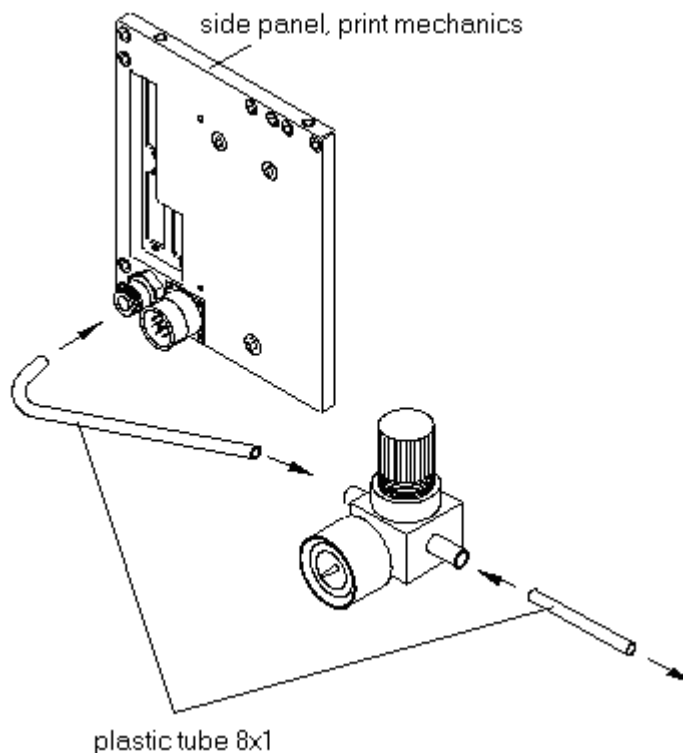
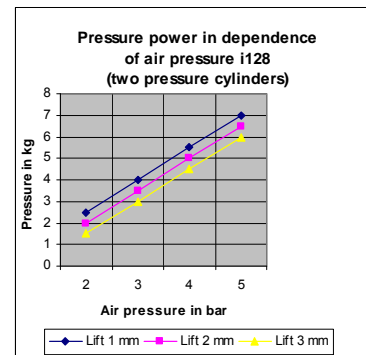
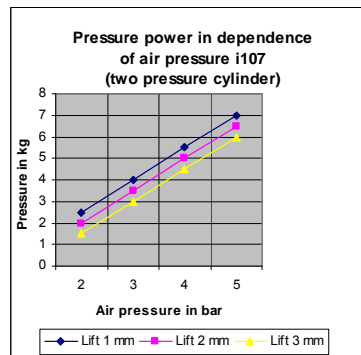
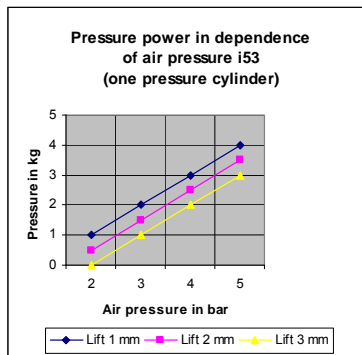

Figure 19

4.3 Adjustment of pressure power



The pressure power of the printhead can be set with the pressure regulator. The values are indicated in the following table:



In case the pressure power is set too low, it is possible that the printhead has no contact to the counter-pressure plate. Because of the missing heat during the print this could damage the printhead. In this case an error message appears. This error message is only to protect the printhead for overheating and is not to use as print quality control.

The lift indicates the distance between printhead and brake stator in 'print less' status.

	DPM III xi53	DPM III xi107	DPM III xi128
Recommended pressure power:	30 N	40 N	40 N
Max. pressure power:	36 N	48 N	48 N

As the mechanical wear and tear of the printhead increases with the pressure power, the pressure power should be as low as possible.

4.4 Connecting the direct print module

Connecting to the power supply

The direct print module is equipped with a versatile power supply unit. The device may be operated with a mains voltage of 230 V / 50-60 Hz without any adjustments or modifications.



CAUTION!

The direct print module can be damaged by undefined switch-on currents.

- ⇒ Set de power switch to '0' before plugging in the direct print module.
- ⇒ Insert power cable into power connection socket.
- ⇒ Insert plug of power cable into a grounded electrical outlet.

Connecting to a computer or to a computer network



Insufficient or missing grounding can cause faults during operation.

Ensure that all computers and connection cables connected to the direct print module are grounded.

- ⇒ Connect direct print module to computer or network with a suitable cable.

4.5 Before initial operation

- Mount print mechanics.
- Connect all cables between print mechanics and control unit.
- Protect cables against unintentional unscrewing.
- Connect compressed air line.
- Connect control unit and PC by printer interface.
- Connect control unit and packaging machine by inputs and outputs.
- Connect power cable of control unit.

4.6 Print control

Because of the fact that the print module is always in control mode it is only possible to transmit and not to start print orders by the available interfaces (serial, parallel, USB or Ethernet). The print is started by a start signal to the 'print start-control input'. It is necessary for the control unit to recognise the moment of setting the start signal and therefore it is possible and also necessary to observe the print status by the outputs.

4.7 Initiation

Once all connections have been made:

- ⇒ Switch control unit on with the power switch.
After switching on the device the main menu appears which shows the model type, current date and time.
- ⇒ Insert transfer ribbon (see chapter 4.8, on page 31).

4.8 Loading transfer ribbon



As for the electrostatic unloading the thin coating of the thermal printhead or other electronic parts can be damaged, the transfer ribbon should be antistatic.

The use of wrong materials can lead to printer malfunctions and the guarantee can expire.

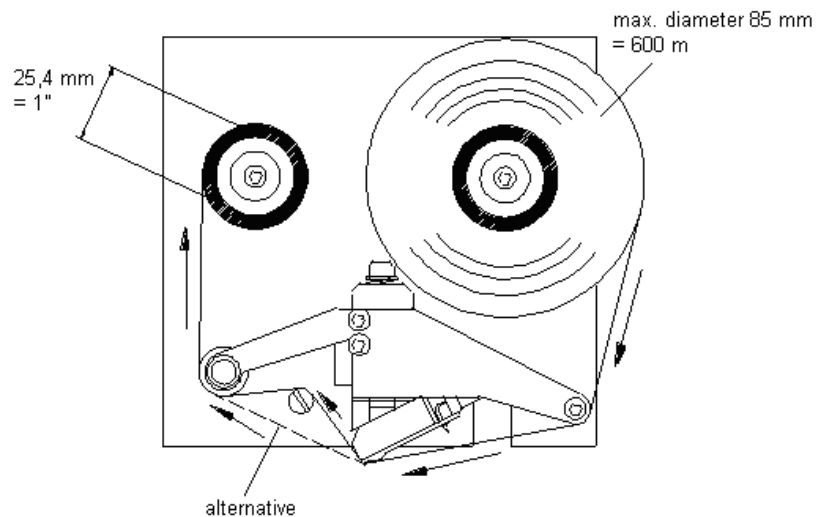

Figure 20



Before loading a new transfer ribbon roll, we recommend to clean the printhead with printhead and roll cleaner (97.20.002).

- Load a new transfer ribbon roll (1) onto the unwinding unit (2) and push it until it stops.





















The colour of the transfer ribbon must be on the outside.

- Load an empty rewinding roll (3) onto the rewinding unit (4) until it stops.
- Load the transfer ribbon according to the illustration.
- Depending on the transfer ribbon, the 'alternative' ribbon guiding can improve the print quality.
- Stick the transfer ribbon with an adhesive tape to the empty roll and tighten the transfer ribbon with some turns of the roll.

5 Foil keyboard

5.1 Keyboard assignment (standard)

Key	Meaning	Function
	Main menu	Back to main menu. Activate test print. Delete stopped print order.
	Up	Printhead upwards.
	Down	Printhead downwards.
	Function menu	Change to function menu. In function menu, one menu item back.
	Feed	In main menu, one layout feed. In function menu, change to next menu item.
	Start/Stop	Confirm settings in function menu. Stop and continue current print order. Delete stopped print order with key  . No further layout of the print order is printed.
	Memory	Change to Compact Flash card menu.
	Quant	Change to number of copies menu. Press keys  and  to select the number of copies that are to print.
	Forwards	In main menu, printing carriage moves to the before set service position. Change to next input field. Press keys  and  to change values.
	Backwards	In main menu, printing carriage moves back to zero point. Change to previous input field. Press keys  and  to change values.
0 - 9	Function keys	Parameter selection (e.g. speed).
F1 + F2	Function keys	No function.
	Function key	Delete complete entry.
	Function key	Confirm entry. After confirmation of settings, return to the main menu.

5.2 Keyboard assignment (text entry/customized)

The control unit of the print module is equipped with an alphanumeric character block which allows the user to enter parameters and customised variables without the connection of an external keyboard. Each key contains letters and similar to the use of a mobile phone (like sms) a direct and time-saving input is possible.

The mode is displayed in the first line at the right position so the user can control in which input mode is selected.

```
Article no.  0
1234_
```

As the input is almost done with characters from one mode, the characters are divided in different groups. Following input modes are available:

```
Color code  M
AB_
```

Symbol	Mode
0	Standard, starting with figures
M	Starting with capital letters
m	Starting with small letters
A	Input Alt
a	Input Alt, is switched off after one character

Mode 0

This mode is displayed as default. At first the figure which corresponds to the key is displayed, then all capital and afterwards the small letters.

Mode M

At first all capital, then the small letters and at last the corresponding figure.

Mode m











At first all small letters, then the figure and at last the capital letters.

Mode A

This mode can be used for the creation of special characters. The desired character can be displayed by the assigned number by entering the ANSI code. Please note that the ANSI code has to consist of three digits, i.e. you have possible to enter a zero first.

Mode a

Same as mode A. After input of the selected ANSI code the machine, however, changes back to the previously selected input mode.

Key	Meaning	Function
	Main menu	Back to main menu. Activate test print. Delete stopped print order.
	Up	For customized variables, change between single entries.
	Down	For customized variables, change between single entries.
	Funktion menu	No function.
	Vorschub	Entry confirmation. Change to the main menu.
	Start/Stop	Confirmation/end of entry.
	Memory	Entry mode selection.
	Quant	Delete character at cursor position. If the cursor is behind the last character, the last one is deleted. Character is only deleted if it was before entered by the character block.
	Forwards	Cursor one position to the right.
	Backwards	Cursor one position to the left.
0 - 9	Character block	Entry of desired data.
F1 + F2	Function keys	No function.
C	Function key	Delete complete entry. The entry is only deleted if it was entered by the character block.
E	Function key	Confirm entry. After confirmation of settings, return to the main menu.

6 Function menu

6.1 Menu structure

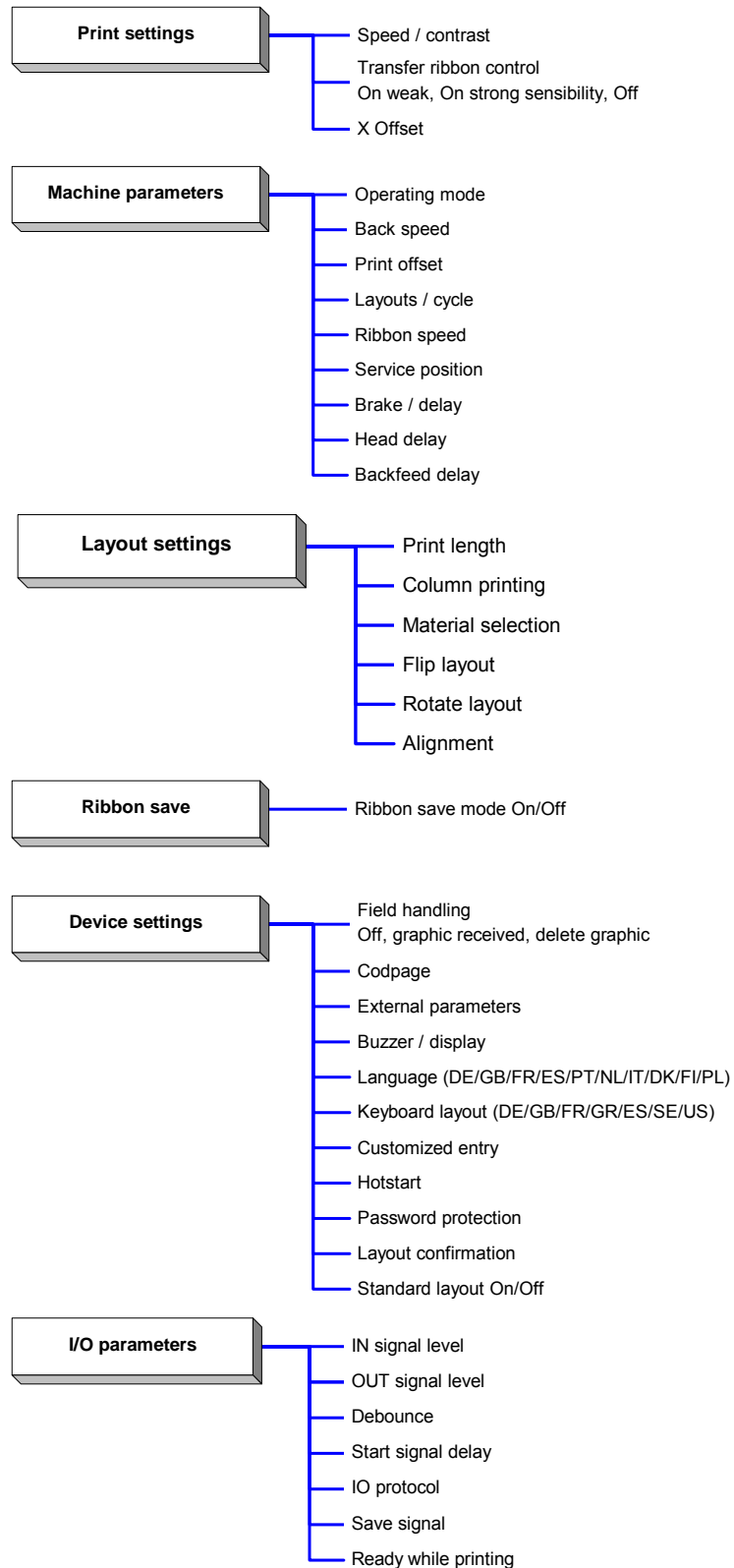

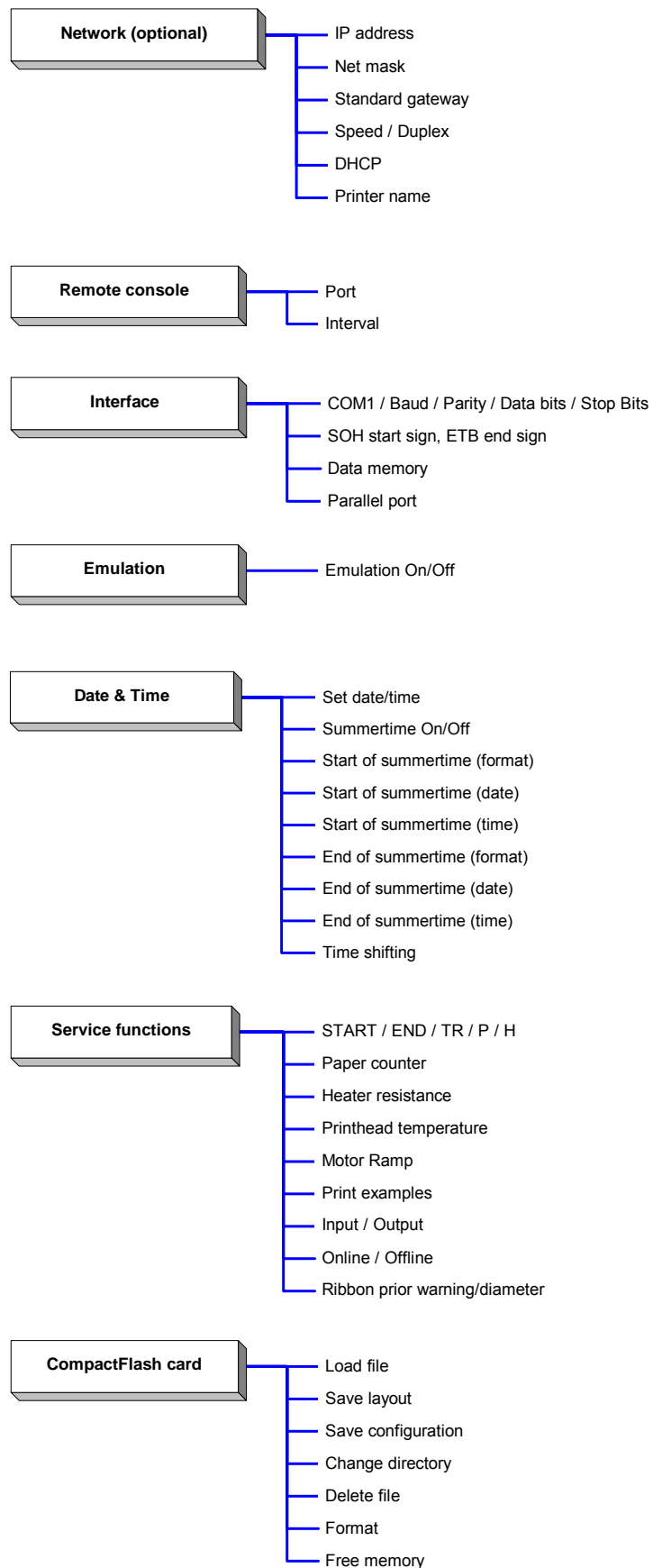

6.2 Print settings

Press key **F** to access the function menu.

Press key **●** to select the menu.

Function Menu
Print Settings

Speed: 100
Contrast: 100

Speed:

Indication of speed in mm/s
(see Technical data, on page 15).

Contrast:

Indication of contrast in %.
Value range: 10% - 200 %.
Step size: 10%.

Press key **▶** to arrive at the next menu item.

Ribbon Control
ON strong sens.

Ribbon control:

Examination if the transfer ribbon roll is to end or if the ribbon was torn at the unwinding roll.

Off: The ribbon control is deselected, i.e. the direct print module continues without an error message.

On: The ribbon control is selected, i.e. the current print order is interrupted and an Error Message appears at the display.

strong sensibility: The direct print module reacts immediately to the end of the transfer ribbon.

weak sensibility: The direct print module reacts at approx. 1/3 more slowly to the end of the transfer ribbon.

Press key **▶** to arrive at the next menu item.

X Displacement
Offs (mm): -1.5

X displacement:

Indication of displacement in X direction. The fields on the layout are moved.

Value range: -90.0 to +90.0.

6.3 Machine parameters

Press key **F** to access the function menu.

Press key **▲** as long as you arrive at the 'Machine Parameters' menu.

Function Menu
Machine Param.

Press key **●** to select the menu.

Mode
2 Fortlaufend

Mode:

Selection of operating mode.

Mode 1 = Single item processing:

A print order with a defined number of pieces is transferred. After the generating process the target number and the actual number of pieces is shown in the display. A cycle is started via signal input 1 or with key **▲**. With each cycle the actual number of pieces is increased by the number of printed layouts. In case the target number of pieces is reached the print order is finished and the display shows again the main menu.

Mode 2 = Continuous mode:

A print order is transferred. After the generating process the number of printed layouts is shown in the display. A cycle is started via signal input 1 or with key **▲**. With each cycle the number of printed layouts is increased. The print order is active as long as it is terminated by the user or in case of new data transmission.

Mode 3:

Actually not used.

Mode 4 = Continuous mode, return without 'layout print' signal:

This operating mode corresponds to mode 2. At the return of the print unit to the zero point of machine, however, the signal output 4 'layout print' is not active.

Mode 5:

Actually not used.

Mode 6 = Test mode:

This operating mode corresponds to mode 2. After the return of the print unit to the zero point of the machine, however, internally a further cycle is started (endurance test).

Mode 7 = Direct start:

A print order is transferred. After termination of generating process the print order is executed without an external signal.

Mode 8 = Single item processing, return without 'layout print' signal:

This operating mode corresponds to mode 4 but not continuous.

Back-Speed mm/s
400

Press key  to arrive at the next menu item.

Back-Speed:

Indication of back speed of the print mechanics after print end in mm/s.

Each cycle of the machine consists of printing and return to the zero point of machine. It is possible to set the print speed and back speed separately. The setting range for the back speed is between 50 and 500 mm/s.

Because of this value you can select for low machine clock cycles an operating method which saves the material and increases in this way the life of the printhead.

Because of the mass moment of inertia it could be better to reduce the speed at an installation position of the print unit at >30° horizontal.

Value range: 50 - 600 mm/s.

Press key  to arrive at the next menu item.

Print Offset
(mm) 10.0

Print offset:

Indication of distance of the layout (res. the first layout in case more layouts per cycles are to be printed) to the zero point of machine.

Value range: 0 - 93 mm

Default: 0 mm

Machine zero point

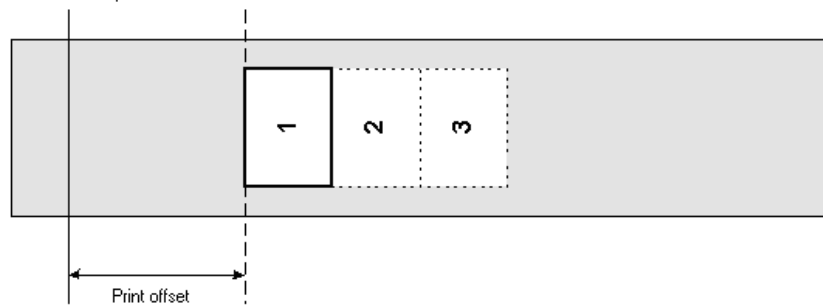

Press key  to arrive at the next menu item.

Layouts/cycle
1

Layouts/cycle:

Indication of the number of printed layouts per print start (cycle).

Value range: 1 - 25.

Machine zero point

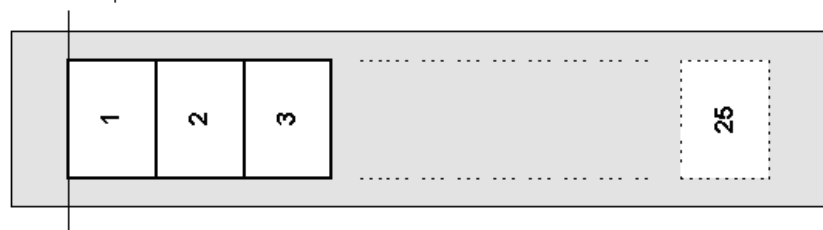

Ribbon-Speed %
100

Press key **▶** to arrive at the next menu item.

Ribbon speed:

Indication of ribbon speed in %.

In this mode it is possible to set the ribbon speed relative to the print speed. Because of a less speed of the ribbon you can reduce the consumption of ribbon. Reducing the ribbon speed can lead to an inferior print quality.

The setting range of the ribbon speed is between 50% and 100%.

The example shows the consumption of transfer ribbon in dependence of the ribbon speed.

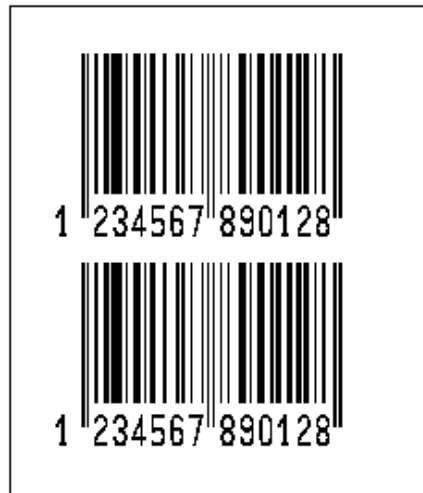

Ribbon Speed = 100%



Ribbon Speed = 75%

Service Position
(mm) 140.0

Service position:

Indication of position in 1/10 mm steps in which the print unit can be moved in times of service. In the main menu click key **▶** to move the print unit in service position. Press key **◀** to move the print unit again to zero point of machine.

Press key **▶** to arrive at the next menu item.

Brake Delay (s)
On 0.60

Brake:

In case the DPM III is installed in vertical position, the option brake should be available and set to On. Is the DPM III installed in horizontal or in variable position the option brake (if available) should be set to Off to avoid deceleration during printing.

Delay:

Indication of delay in 1/100 seconds. By means of this parameter it is possible to delay the closure of brake. If during the delay time no start impulse for printing a new cycle is effected, then the brake is closed. If the delay time is set to 0, the brake is closed immediate after return to zero point of machine.

Head Delay
(ms) 30

Press key  to arrive at the next menu item.

Head delay:

With the 'head delay' parameter, the time between moving down and start of movement of printing carriage can be set.

If fields are directly at the beginning of layout, the printhead is moved down before the printing carriage starts to move. The necessary time for moving down depends on the lift of printhead.

Default: 30 ms.

Press key  to arrive at the next menu item.

Backfeed Delay
(ms) 0

Backfeed delay:

Setting of time between end of print cycle and beginning of return of the printing carriage to the zero point.

Default: 50 ms.

6.4 Layout settings

Press key **F** to access the function menu.

Press key **▶** as long as you arrive at the 'Layout settings' menu.

Press key **●** to select the menu.

Function menu
Layout settings

Print length (mm)
120.0

Print length:

Indication of way which the print mechanics has to move. The print length depends on the length of the print mechanics.

Press key **▶** to arrive at the next menu item.

Width: 20.0
Columns: 4

Column printing:

Indication of width of one layout as well as how many layouts are placed side by side (see chapter 11.1 Column printing, on page 83).

Press key **▶** to arrive at the next menu item.

Material
Type 2

Material selection:

Selection of the used print media.

Press key **▶** to arrive at the next menu item.

Flip layout
Off

Flip layout:

The axis of reflection is in the middle of the layout. If the layout width was not transferred to the module, automatically the default layout width i.e. the width of the printhead is used. Because of this reason you have to note that the layout should have the same width as the printhead as otherwise this could lead to problems in positioning.

Press key **▶** to arrive at the next menu item.

Rotate layout
On

Rotate layout:

As default the layout is printed with 0° head forward. In case of an activated function, the layout is rotated by 180° and it is printed in reading direction.

Press key **▶** to arrive at the next menu item.

Alignment
Left

Alignment:

The adjustment of layout is effected only after 'flip/rotate label', i.e. the adjustment is independent of the functions flip and rotate layout.

Left: The layout is aligned at the left-most position of printhead.

Centre: The layout is aligned at central point of printhead.

Right: The layout is aligned at right-most position of printhead.

6.5 Ribbon save

Ribbon save = maximum utilisation of transfer ribbon



Function menu
Ribbon save

Press key **F** to access the function menu.

Press key **▶** as long as you arrive at the 'Ribbon save' menu.

Press key **●** to select the menu.

Press key **▲** so switch the ribbon save function On or Off.

6.6 Device settings

Press key **F** to access the function menu.

Press key  as long as you arrive at the 'Device Settings' menu.

Press key  to select the menu.

Function Menu
Device Settings

Field Handling
OFF

Field handling:

Off: The complete print memory is deleted.

Keep graphic: A graphic res. a TrueType font is transferred to the direct print module once and stored in the direct print module internal memory. For the following print order only the modified data is transferred to the direct print module. The advantage is the saving of transmitting time for the graphic data.

The graphic data created by the direct print module itself (internal fonts, bar codes, ...) is generated only if they were changed. The generating time is saved.

Delete graphic: The graphics res. TrueType fonts stored in the internal memory is deleted but the other fields are kept.

Press key  to arrive at the next menu item.

Codepage
ANSI charset

Codepage:

Indication of the font used in the direct print module.

The following possibilities are available:

ANSI character set / Codepage 437 / Codepage 850 / GEM German / GEM English / GEM French / GEM Swedish / GEM Danish.

Press key  to arrive at the next menu item.

ext. Parameters
ON

External parameters:

On: Sending parameters such as print speed and contrast via our creation software to the direct print module. Parameters which are set directly at the direct print module before are no longer considered.

Off: Only settings made directly at the direct print module are considered.

Press key  to arrive at the next menu item.

Buzzer Display
ON 3

Buzzer:

An acoustic signal is audible when pressing a key.

Value range: 1 - 7.

Off: No signal is audible.

Display:

Setting the contrast of display.

Value range: 0 to 7

Press key  to arrive at the next menu item.

Language
English

Language:

Selection of language in which you want to display the text in the display.

At the moment the following languages are available: German, English, French, Spanish, Portuguese, Dutch, Italian, Danish, Finnish or Polish.

Keyboard Layout
England

Press key  to arrive at the next menu item.

Keyboard layout:

Selection of region for the desired keyboard layout.

The following possibilities are available: Germany, England, France, Greece, Spain, Sweden and US.

Press key  to arrive at the next menu item.

Customized Entry
On

Customized entry:

On: The question referring the customized variable appears once before the print start at the display.

Auto: The question referring the customized variable appears after every printed layout.

Off: No question appears at the display. In this case the stored default value is printed.

Press key  to arrive at the next menu item.

Hotstart
Off

Hotstart:

On: Continue an interrupted print order after switching on the direct print module anew.

Off: After switching off the direct print module the complete data is lost (see chapter 11.3, on page 86).

Press key  to arrive at the next menu item.

Password Prot.
Active

Password:

By a password several functions can be blocked, so the user cannot work with them. There are several applications in which the use of password protection makes sense (see chapter 11.2 Password, page 84).

Press key  to arrive at the next menu item.

Layout P/Me Conf
On Off

Layout confirmation:

On: A new print order is only printed after confirmation at the device. An already active continuing print order is printed as long as the confirmation is effected at the device.

Off: No query appears at the display of control unit.

P/Me (print after measuring):

On: If an error occurred during printing, whose removal can be recognized by the module (e.g. transfer ribbon end, cassette open), then the module changes after the error correction (e.g. cassette closed again) immediately in the 'ready' mode.

Off: After removal and confirmation of error, the module changes into 'stopped' mode.

Press key  to arrive at the next menu item.

Standard layout
Off

Standard layout:

On: If a print order is started without previous definition of layout, the standard layout is printed.

```

P OS 108/12 R
V1.50 (Build 0001 )

NO LABEL DATA
  
```

Off: If a print order is started without previous definition of layout, an error message appears in the display.

6.7 I/O parameters

Press key **F** to access the function menu.

Press key **▶** as long as you arrive at the 'I/O Parameter' menu.

Press key **●** to select the menu.

Function Menu
I/O Parameter

IN signal level
1s2x3+4x5x6x7x8x

IN signal level:

Indication of signal at which a print order is started.

- + = active signal level is 'high' (1)
- = active signal level is 'low' (0)
- x = not activated signal level
- s = status can be affected by interface*

The modification of the signal level is only taken into consideration for the operating modes I/O static, I/O dynamic, I/O static continuous and I/O dynamic continuous.

Press key **▶** to arrive at the next menu item.

OUT signal level:

Indication of signal level for output signal.

- + = active signal level is 'high' (1)
- = active signal level is 'low' (0)
- s = Zustand kann über Schnittstelle beeinflusst werden*

Press key **▶** to arrive at the next menu item.

OUT signal level
1+2+3+4+5+6+7+8+

Debounce (ms)
50

Debounce:

Indication of debounce time of the dispenser input. The setting range of the debounce time is between 0 and 100 ms.

In case the start signal is not clear then you can debounce the input by means of this menu item.

Press key **▶** to arrive at the next menu item.

Start delay (s)
1.00

Start signal delay:

Indication in time per second of the delay for the start signal.

Value range: 0.00 to 9.99.

Press key **▶** to arrive at the next menu item.

IO protocol
Port: Off

IO protocol:

Indication of interface at which the modifications of input signals (I/O) were send.

Press key **▶** to arrive at the next menu item.

Save signal
On

Save signal

On: The start signal for the next label can already be released during printing the current label. The signal is registered from the printer. The printer starts printing the next label immediately after finishing the current one. Therefore time can be saved and performance be increased.

Off: The start signal for the next label can only be released if the current label is printed to the end and the printer is again in 'waiting' state (output 'ready' set). If the start signal was released already before, so this is ignored.

* in combination with Netstar PLUS

ReadyWhilePrint
Off

Press key  to arrive at the next menu item.

Ready while printing:

Indication if the output signal 'print ready' (Out 5, Output II) remains active while printing.

Off: At print start the 'print ready' signal is inactive (default setting).

On: At print start the 'print ready' signal remains active.

6.8 Network (option)

Press key **F** to access the function menu.

Press key  as long as you arrive at the 'Network' menu.

Function Menu
Network

Option Ethernet
not available

It is only possible to select this menu item in case a network card is recognised at switching on the printer, otherwise a message appears that the option is not available.

For more information, please see the separate manual.

6.9 Remote console

Press key **F** to access the function menu.

Press key  as long as you arrive at the 'Remote Console' menu.

Function Menu
Remote Console

For more information please contact our sales department.

6.10 Interface

Press key **F** to access the function menu.

Press key **▶** as long as you arrive at the 'Interface' menu.

Press key **●** to select the menu.

```
Function Menu
Interface
```

```
COM1 Baud P D S
0      9600 N 8 2
```

COM1:

0 - serial interface Off.

1 - serial interface On.

2 - serial Interface On, no error message occurs in case of a transmission error.

Baud rate:

Indication of bits which are transferred per second.

Following values are possible: 1200, 2400, 4800, 9600, 19200.

P = Parity:

N - No parity; E - Even; O - Odd

Please observe that the settings correspond to those of the direct print module.

D = Data bits:

Setting of data bits.

Value range: 7 or 8 Bits.

S = Stop bits:

Indication of stop bits between bytes.

Value range: 1 or 2 stop bits.

Press key **▶** to arrive at the next menu item.

```
Start (SOH): 01
End   (ETB): 17
```

SOH: Start of data transfer block → Hex format 01

ETB: End of data transfer block → Hex format 17

Two different start / end signs can be set. The settings are normally SOH = 01 HEX and ETB = 17 HEX. Several host computers cannot process these signs and therefore SOH = 5E HEX and ETB = 5F cannot be set.

Press key **▶** to arrive at the next menu item.

```
Data Memory
Standard
```

Data memory:

Standard: After starting a print order the direct print module buffer receives data as long as it is filled.

Advanced: During a current print order data is received and processed.

Off: After starting a print order no more data is received.

Press key **▶** to arrive at the next menu item.

```
Parallel Port
SPP
```

Parallel port:

SPP - Standard Parallel Port

ECP - Extended Capabilities Port (enables a fast data transmission but it is only to set at PCs of newer version).

Observe that the settings correspond to those of the PC.

6.11 Emulation

Press key **F** to access the function menu.

Press key  as long as you arrive at the 'Emulation' menu.

Function menu
Emulation

Press key  to select the menu.

Protocol
ZPL

Protocol:

CVPL: Carl Valentin Programming Language

ZPL: Zebra® Programming Language

Change between CVPL protocol and ZPL II® protocol.

Press key  to confirm the selection.

The printer performs a restart and ZPL II® commands are transformed into CVPL commands internally by the printer and then executed by the printer.

Press key  in menu protocol to arrive at the next menu item.

Head Resolution
11.8 (Dot/mm)

Printhead resolution:

At activated ZPL II® emulation the printhead resolution of the emulated printer must be set, e.g. 11.8 Dot/mm (= 300 dpi).



If the printhead resolution of the Zebra® printer differs from that of the Valentin printer, then the size of objects (e.g. texts, graphics) complies not exactly.

Press key  to arrive at the next menu item.

Drive mapping
B:->A: R:->R:

Drive mapping:

The access to Zebra® drives

B: Memory Card

R: RAM Disk (standard drive, if not indicated)

is rerouted to the corresponding Valentin drives

A: Memory Card (slot 1) and/or Compact Flash

B: Memory Card (slot 2)

R: RAM Disk

This can be necessary if the available space on the RAM disk (at present. 512 KByte) is not sufficient or if bitmap fonts are downloaded to the printer and be stored permanently.



As the printer build-in fonts in Zebra® printers are not available in Valentin printers, this can cause small differences in the text image.

6.12 Date & time

Press key **F** to access the function menu.

Press key **▶** as long as you arrive at the 'Date/Time' menu.

Press key **●** to select the menu.

```
Function menu
Date/Time
```

```
Date    17.11.04
Time    13:28:06
```

```
Summertime
On
```

```
ST start format
WW/WD/MM
```

```
WW    WD    MM
last  sunday 03
```

```
ST start time
02:00
```

```
ST end format
WW/WD/MM
```

```
WW    WD    MM
last  sunday 10
```

```
ST end time
03:00
```

```
Time shifting
01:00
```

Set date and time:

The upper line of display shows the current date, the second line the current time.

With keys **◀** and **▶** you can change to the next or previous field. With keys **▲** and **▼** you can increase and/or decrease the displayed values.

Press key **▶** to arrive at the next menu item.

Summertime:

On: Direct print module automatically adjust clock for daylight saving changes.

Off: Summertime is not automatically recognized and adjusted.

Press key **▶** to arrive at the next menu item.

Start of summertime (format):

Select the format in which you want to define beginning summertime. The above example indicates the default setting (European format).

DD = day WW = week WD = weekday

MM = month YY = year next day = only next day is taken into consideration

Press key **▶** to arrive at the next menu item.

Start of summertime (date):

By means of this function you can enter the date at which summertime has to start. This entry refers to the previously selected format.

Example: summertime is automatically adjusted at last Sunday in March (03).

Press key **▶** to arrive at the next menu item.

Start of summertime (time):

By means of this function you can define the time when you want to start summertime.

Press key **▶** to arrive at the next menu item.

End of summertime (format):

Select the format in which you want to define end of summertime.

The above example indicates the default setting (European format).

Press key **▶** to arrive at the next menu item.

End of summertime (date):

By means of this function you can define the date when you want to stop summertime. The entry refers to the previously selected format.

Example: summertime is automatically adjusted at last Sunday in October (10).

Press key **▶** to arrive at the next menu item.

End of summertime (time):

By means of this function you can define the time when you want to stop summertime.

Press key **▶** to arrive at the next menu item.

Time shifting:

By means of this function you can enter time shifting in hours and minutes (for automatically adjustment from summer and wintertime). This entry refers to the currently set direct print module time.

6.13 Service functions



In order that the distributor res. the manufacturer can provide fast support in case of malfunction, the direct print module is equipped with the Service functions menu.

Necessary information such as set parameters is indicated directly at the direct print module.

More information such as firmware or font version is shown in main menu (6.14, on page 55).

Press key **F** to access the function menu.

Press key  as long as you arrive at the 'Service Function' menu.

Press key  to select the menu.

```
Function Menu
Service Function
```

```
START END TR P H
0 0 0 1 1
```

Photocell parameters:

Start = Indication of Start photocell (0 or 1) status.

End = Indication of End photocell (0 or 1) status.

TR = Indication of transfer ribbon photocell status (0 or 1).

P = Pressure:

Indication of value for compressed-air control (0 or 1).

H = Head:

Indication of value 0 or 1 for the position of machine cover.

0 - cover open, 1 - cover closed

Press key  to arrive at the next menu item.

```
Paper Counter
D000007 G000017
```

Paper counter:

D: Indication of printhead attainment in meters.

G: Indication of direct print module attainment in meters.

Press key  to arrive at the next menu item.

```
Heater Resist.
1250
```

Heater resistance:

To achieve a high print quality, the indicated Ohm value must be set after an exchange of printhead.

Press key  to arrive at the next menu item.

```
Printhead Temp.
23
```

Printhead temperature:

Indication of printhead temperature. The printhead temperature corresponds normally to the room temperature. In case the maximum printhead temperature is exceeded, the current print order is interrupted and an error message appears at the direct print module display.

Press key  to arrive at the next menu item.

```
Motor Ramp
++ 2 -- 2
```

Motor / Ramp:

The higher the '++' value is set, the slower the feeding motor is accelerated.

The smaller the '--' value is set, the faster the feeding motor is limited.

This function is often used for high printing speed as the tearing of transfer ribbon can be prevented.

Print Examples
Settings

Press key  to arrive at the next menu item.

Print examples:

Settings: Printout of all settings such as speed, and transfer ribbon material.

Bar codes: Printout of all available bar code types.

Fonts: Printout of all available font types.

Press key  to arrive at the next menu item.

Input: 11111111
Output: 00000000

Input/Output:

Indication of signal level which indicates the signal a print order is started.

0 - Low; 1 - High

Press key  to arrive at the next menu item.

On/Offline
Off

Online/Offline:

This function is activated e.g. if the transfer ribbon is to be changed. It is avoided that a print order is processed although the module is not ready. If the function is activated then press the key  to change between Online and Offline mode. The respective state is indicated in the display.

Standard: Off

Online: Data can be received by interface. The keys of the foil keyboard are only active, if you changed in the Offline mode with key .

Offline: The keys of the foil keyboard are still active but received data are not processed. If the module is again in Online mode then new print orders can be again received.

Press key  to arrive at the next menu item.

TR advance warn.
On ø: 40 v: 100

TRB = Transfer ribbon advance warning:

Before the end of transfer ribbon, a signal is send by the control output.

Warning diameter:

Setting of transfer ribbon advance warning diameter.

In case you enter a value in mm then a signal appears via control output when reaching this diameter (measured at transfer ribbon roll).

v = Reduced print speed:

Setting of the reduced print speed. This can be set in the limits of the normal print speed. Additionally there are the following settings:

-: No reduced print speed

0: Printer stops at reaching the warning diameter and indicates 'ribbon error'.

6.14 Main menu

After switching on the direct print module the left indicated display shows the following:

```
DPM xi107-12 K
22/08/07 15:38
```

The first line of main menu indicates used device type.
The second line indicates current date and time.

Press key  and the display shows the following:

```
DPM xi107-12 K
V1.49a
```

The second line of display indicates version number of firmware.
After a short time the indication of display returns automatically to main menu.

Press again key  and the display shows the following:

```
DPM xi107-12 K
Build 0106
```

Indication of software Build version.

Press again key  and the display shows the following:

```
DPM xi107-12 K
Aug 8 2007
```

Indication of firmware creation date.

Press again key  and the display shows the following:

```
DPM xi107-12 K
10:51:25
```

Indication of firmware creation time.

Press again key  and the display shows the following:

```
DPM xi107-12 K
B-Font: V5.01
```

Indication of font version of bitmap fonts.

Press again key  and the display shows the following:

```
DPM xi107-12 K
V-Font: V6.01
```

Indication of font version of vector fonts.

Press again key  and the display shows the following:

```
DPM xi107-12 K
FPGA P:02 I:01
```

The second line of display indicates version numbers of both FPGA
(P = printhead; I = I/O).

Press again key  and the display shows the following:

```
DPM xi107-12 K
BOOT-SW V1.4d
```

Indication of version number of boot software.

Press again key  and the display shows the following:

```
DPM xi107-12 K
4 MB FLASH
```

Indication of memory size of FLASHs in MB.

7 Compact Flash card

This print module series are equipped with a slot for Compact Flash card. By means of this memory card you can permanently save via interface graphics, text, layout data or information from database.



In case of a malfunction of your original memory card we recommend a copy of your most important data. Please use a commercial Compact Flash reader for PC.

Insertion and removal of Compact Flash card

Insert Compact Flash card with contact side forwards to the slot that was planned for it.

In order to prevent wrong insertion of cards, both sides of Compact Flash cards have different guiding.

A small part of Compact Flash card is visible at the support at the direct print module rear, so you can remove the card easily with hand.



Please note that we support only Compact Flash cards of type 1 at the moment. The use of micro drives is not intended at this time.

File and/or directory name

```
→<.> 0
A:\STANDARD\
```

```
→<Directory>
A:\STANDARD\
```

The direct print module handles your Compact Flash card as a DOS compatible file system.

After formatting Compact Flash card the STANDARD directory is automatically available. After switching on the direct print module or inserting Compact Flash card, this directory is the current one. Main and sub-directories are indicated in <> (e.g. <Directory>).



The maximum length of directory is 254 characters. It is not allowed to use the following characters neither in file nor in directory names:

```
: \ " * / < > ? |
```



Press key  to indicate the saved layouts onto the Compact Flash card.

Press key **F** to enter the Compact Flash card menu.

Press key  to arrive at the next menu item.

Press key **F** to return to the previous menu item.

Press key  to select a menu and to confirm a query.

Press key  and  to browse the contents of the current directory.

Press key  and  to change to the indicated directory.



Before first use of Compact Flash card in your direct print module we recommend to format the card in your direct print module.

Selecting layoutKeys: 

```
→layout01      0
A:\STANDARD
```

Press key ◀ and ▶ to select the desired label in STANDARD directory.

```
Start print
No.layout: 12345
```

Press key ● to select the layout.

Select the number of layouts which you want to print.

Press key ● to start the print order.

After finishing the print order the display shows again the main menu.



It is NOT possible to change the directory. Enter the menu 'Change dir' to change the directory.

Loading file from Compact Flash cardKeys: , **F**

```
CF Functions
Load file
```

Press key ● to select the 'Load file' menu item.

```
→<STANDARD>  0
A:\
```

Select the file you want to load and confirm the selection with key ●. The loaded layout is now in the printer internal storage and after the loading procedure the display shows the main menu.

Press key  and enter the desired number you want to print. Confirm the selection with ● and the print order is started by an external signal (Input 1, PIN 1 and PIN 4).

Saving layout onto Compact Flash cardKeys: , **F**, 

```
CF Functions
Save layout
```

Press key ● to select the 'Save layout' menu item.

Select the directory and/or layout you want to save and confirm the selection with key ●.

```
File exists
Overwrite?
```

Confirm the query with ● and the layout will be saved.

After the saving procedure the display shows again the main menu.

Saving the configuration

CF Functions
Save config

Keys: , **F**, , 

Press key  to select the 'Save configuration' menu item.
As standard, the proposed file name is config.cfg. This name can be changed by the user. In this file the parameters of print module are saved which are not saved permanent in the internal Flash.

Press key  to start the saving procedure.
After the saving procedure, the display shows again the main menu.

Changing the directory





CF Functions
Change directory

←<.> M
A:\STANDARD\

Keys: , **F**, , , 

Press key  to select the 'Change directory' menu item.

The lower line of display shows the directory which is selected at the moment.

Press key  and  to change the directory in the upper line.
Press key  and  to show all available directories.

Press key  to confirm the selected directory.
After changing the directory the display shows again the main menu.

Deleting file from Compact Flash card

CF Functions
Delete file

x<.> M
A:\STANDARD

Keys: , **F**, , , , 

Press key  to select the 'Delete file' menu item.

Select directory and/or layout you want to delete and confirm the selection with key .

The selected layout is deleted from the Compact Flash card.

After the deleting procedure the display shows again the first menu item 'Load file'.

Formatting Compact Flash card



The formatting procedure is recommended before using the Compact Flash card for the first time in the label printer.

Keys: , **F** , , , , , ,

CF Functions
Format

Press key to select the 'Format' menu item.

Format A:

Press key to confirm the selection and the procedure is started.

When formatting the Compact Flash card the STANDARD directory is automatically created.

After the formatting procedure the display shows again the 'Load file' menu item.

Indication of free memory space

Keys: , **F** , , , , , ,

CF Functions
Free memory

Press key to select the 'Free memory' menu item.

Free memory
A: 253920 KB

The still available memory space onto Compact Flash card is indicated.

Press key to display again the 'Load file' menu item.

8 Maintenance and cleaning



DANGER!

Risk of death by electric shock!

- ⇒ Disconnect the direct print module from power supply before performing any maintenance work.

8.1 Cleaning the printhead

Printing can cause accumulation of dirt at printhead e.g. by colour particles of transfer ribbon, and therefore it is necessary to clean the printhead in regular periods depending on operating hours, environmental effects such as dust etc.



CAUTION!

Printhead can be damaged!

- ⇒ Do not use sharp or hard objects to clean the printhead.
- ⇒ Do not touch protective glass layer of the printhead.
- Remove transfer ribbon material.
- Clean printhead surface with special cleaning pen or a cotton swab dipped in pure alcohol.
- Allow printhead to dry for 2-3 minutes before commissioning the device.

8.2 Replacing printhead



CAUTION!

The printhead can be damaged by static electricity discharges and impacts!

- ⇒ Set up direct print module on a grounded, conductive surface.
- ⇒ Ground your body, e.g. by wearing a grounded wristband.
- ⇒ Do not touch contacts on the plug connections (2, 3).
- ⇒ Do not touch printing line (5) with hard objects or your hands.

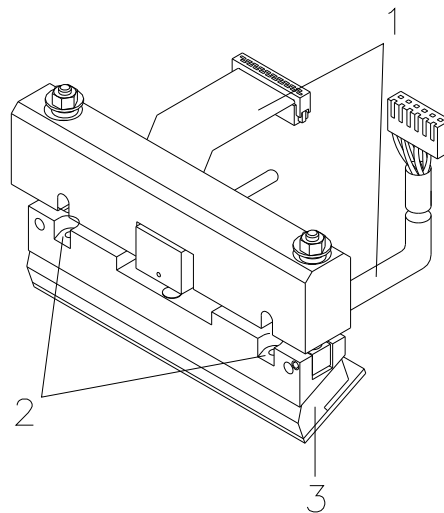
**Figure 21****Removing the printhead**

- Remove transfer ribbon material.
- Move printhead unit in an appropriate service position.
- Remove printhead cable (1).
- Remove screws (2) and afterwards the printhead (3).

Installing the printhead

- Do not touch the contacts of printhead.
- Position the printhead in the printhead support.
- Screw again screws (2) and tighten it.
- Connect again printhead cable (1).
- Insert again the transfer ribbon material (see 4.8. on page 31).
- Enter the resistance value of the new printhead in the 'Service Functions' (heater resistance). The value is indicated on the type plate of printhead.
- Start a test print to check printhead position.

8.3 Transfer ribbon tension

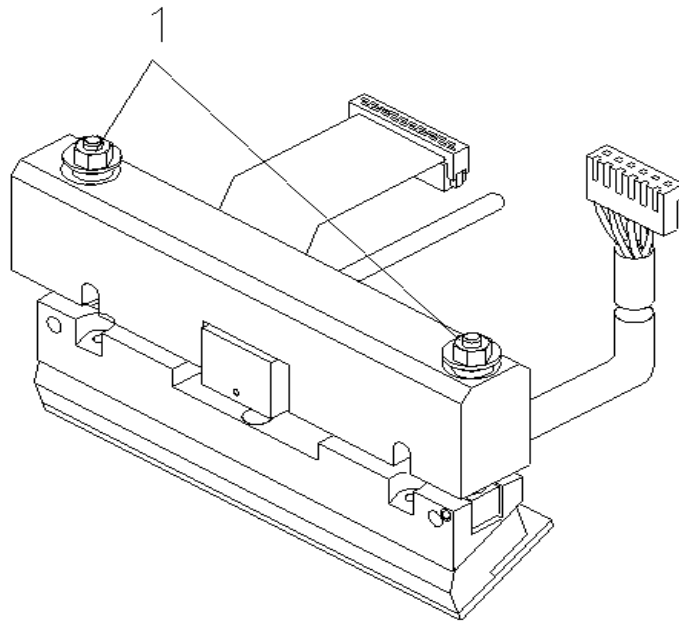

Figure 22

For a regular print quality it is necessary that the transfer ribbon is to tighten even over its width. With the nuts (1) it is possible to regulate a different transfer ribbon tension by a sideways overturn of the printhead.



CAUTION!

Folding at transfer ribbon!

⇒ Change factory settings only in exceptional cases.

- By loosen a nut the printhead moves down at the corresponding side.
The transfer ribbon tension is increased.
- By tightening a nut the printhead moves up at the corresponding side.
The transfer ribbon tension is reduced.



A strong regulation has result to the pressure power of printhead.

- Start a print order with approx. 3 layouts to check the correct unwrinkled ribbon run.

8.4 Angle adjustment

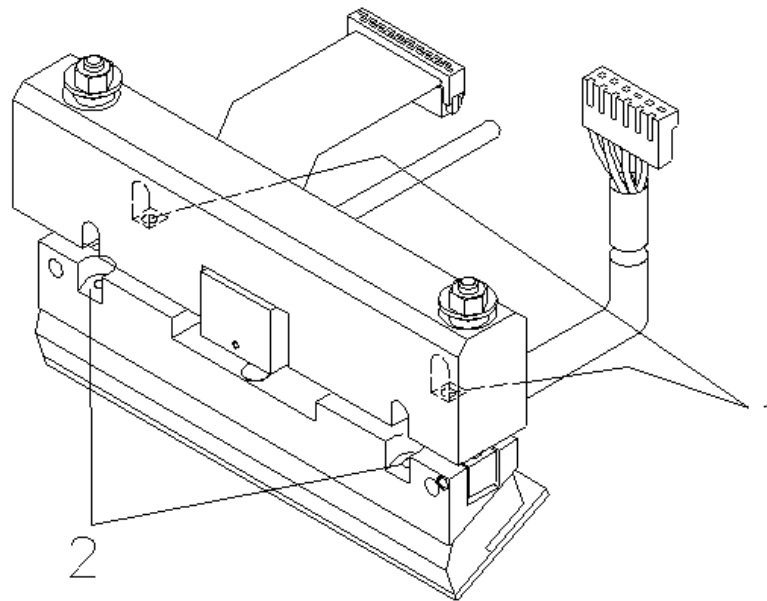

Figure 23

The installation angle of the printhead is default 26° to the print surface. However, manufacturing tolerances of printhead and mechanics can require another angle.



CAUTION!

Damage of printhead by unequal use!
Higher wastage of ribbon by faster ripping.

⇒ Change factory settings only in exceptional cases.

- Loosen slightly two Allen head screws (2).
- Move setscrews (1) to adjust the angle between printhead and printhead support.
Tighten = decrease angle
Loosen = increase angle
- Beide Gewindestifte sind immer gleich weit zu verdrehen.
- Tighten again the Allen head screws (2).
- Start a print order with approx. 3 layouts to check the correct unwrinkled ribbon run.



The slots serve for position control. Pay attention to a parallel adjustment.

8.5 Zero point adjustment

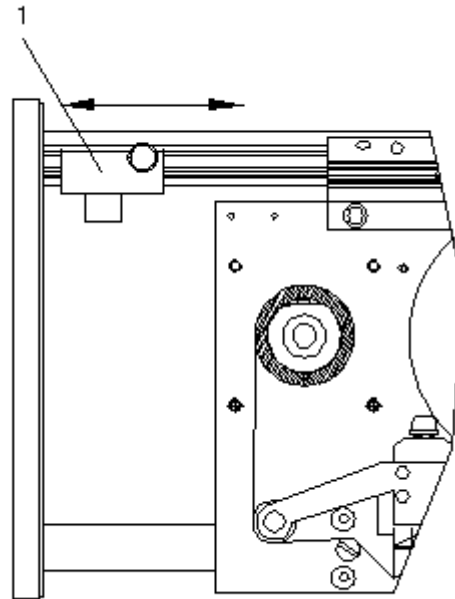

Figure 24

By means of a slider (1) you have the possibility to change the printer zero point.

In case the slider is at the end of its guiding then the maximum print length is available.

If you change the zero point the way from zero point to the print start is shortened. Moreover you can use the change of zero point to change the printhead position of the foil which is to be printed.

By changing the zero point of printer the print area is more shorten.

8.6 Print quality optimisation

The following table shows some possibilities to improve the print quality.

Generally you have to note: the higher the print speed the lower the print quality.

Problem	Possible solution
Regular inferior print quality	<ul style="list-style-type: none"> • Increase contrast • Increase pressure • Control 'alternative' transfer ribbon guiding • Reduce print speed • Reduce transfer ribbon speed • Reduce distance between printhead and print surface • Change combination of transfer ribbon and print medium • Control print surface (too soft) • Change print angle
Partial inferior print quality (on one side)	<ul style="list-style-type: none"> • Align surface parallel to printhead • Set regular transfer ribbon tension • Set regular printhead angle
Partial inferior print quality (periodical)	<ul style="list-style-type: none"> • Sharp surface even • Reinforce surface against bending

8.7 Cycle optimisation

Taktzahl = abgeschlossener Druckzyklus pro Zeiteinheit.

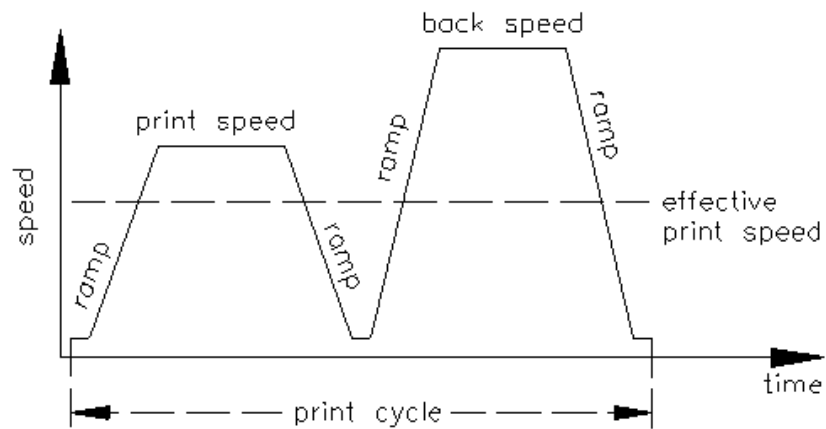

Figure 25

In case of 'time critical' applications you have the possibility with a good selection of different device parameters to increase the effective print speed and in this way the clock cycle.

- Generally increase the print speed.
- Generally increase the back speed.
- Increase acceleration and brake ramp.
- Change zero point of machine.
- Avoid vertical installation position of print mechanics. Install the machine in horizontal position.
- Control the short distance between printhead and print surface.
- Optimise the layout to a short print way, i.e. less blanks, no borders at the top res. bottom, rotate the layout.

9 Signal diagrams

9.1 Mode 1 (single item processing)

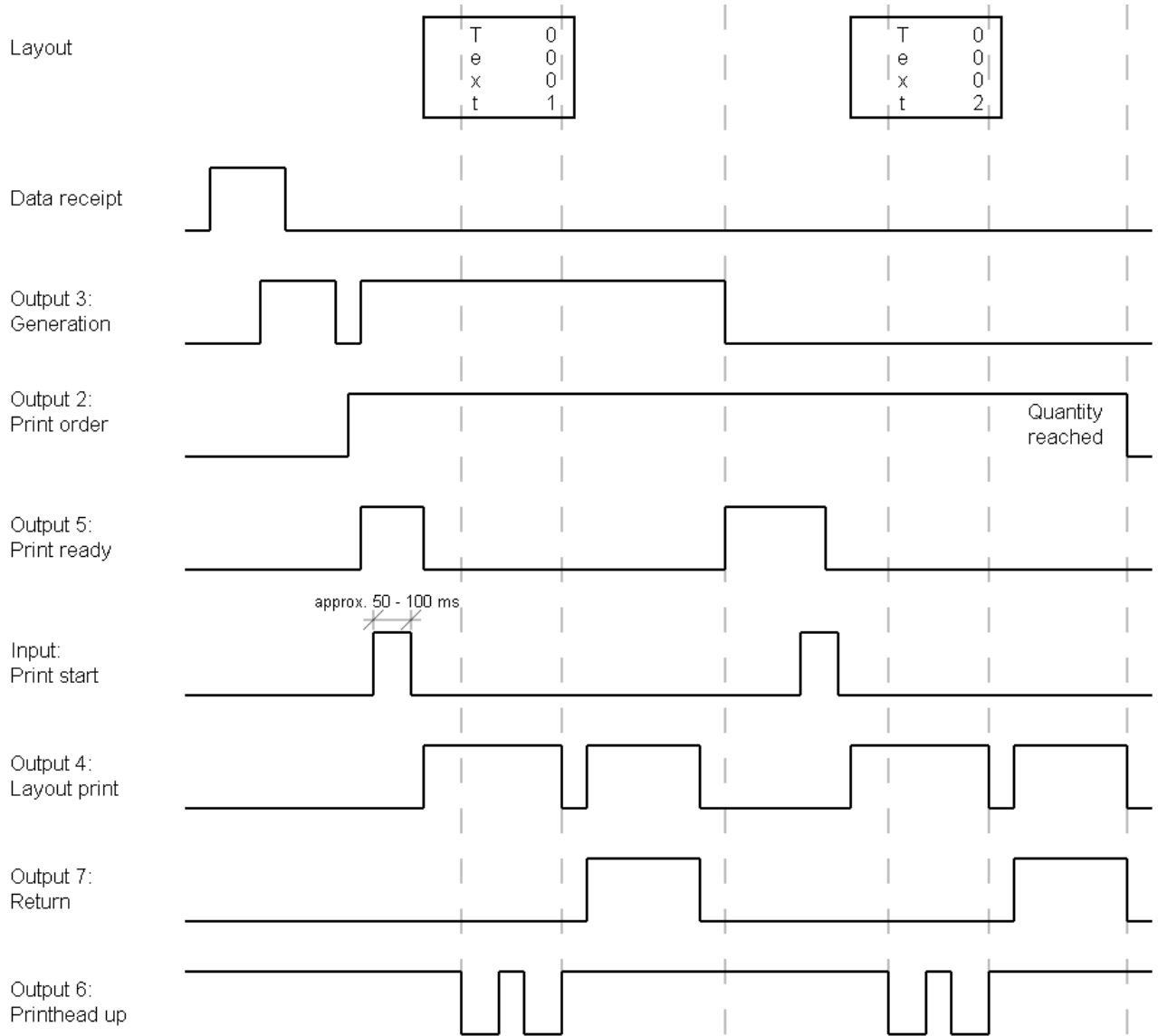

9.2 Mode 2 (continuous mode)

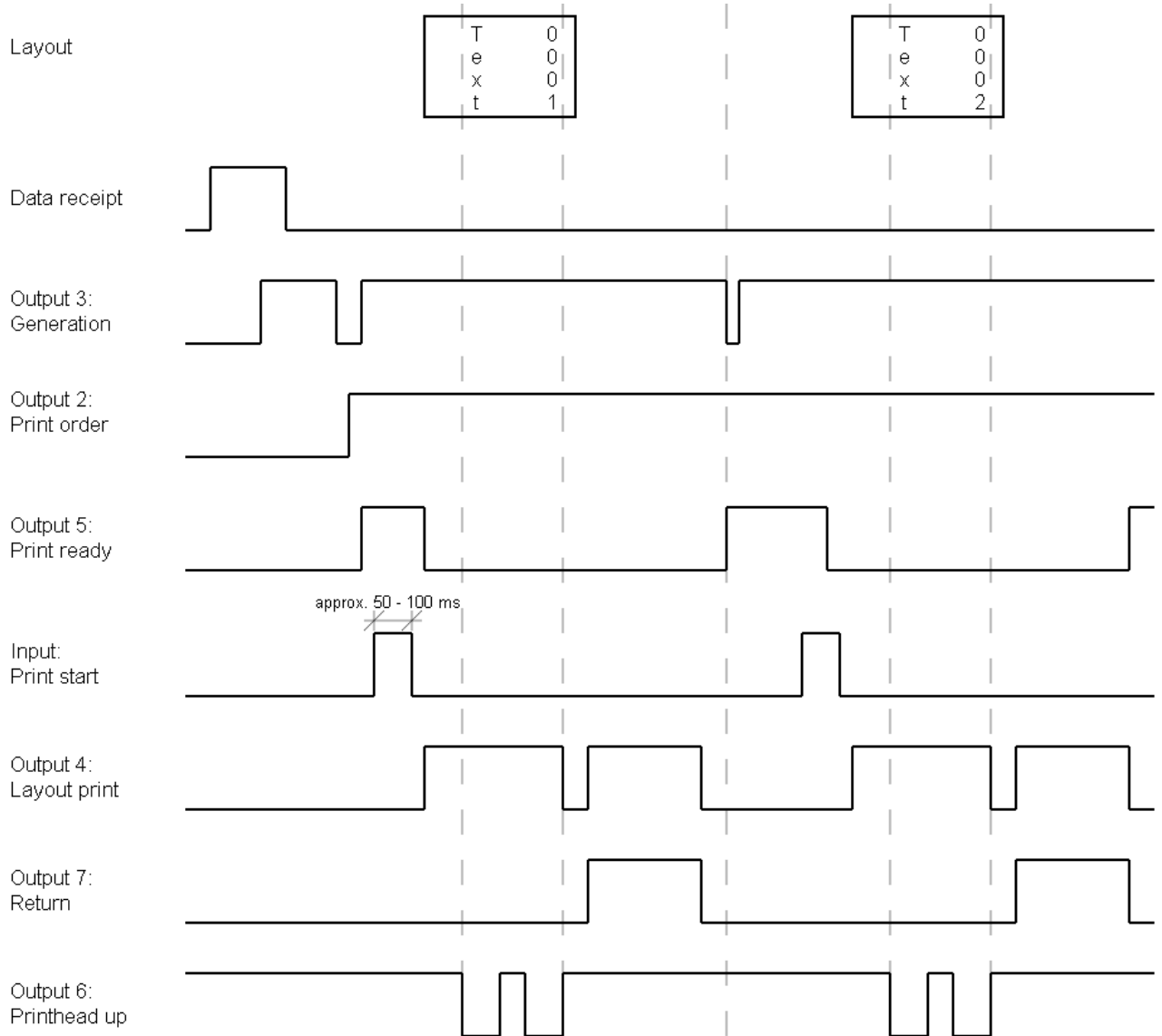

9.3 Mode 4 (continuous mode)

Return without 'layout printing' signal

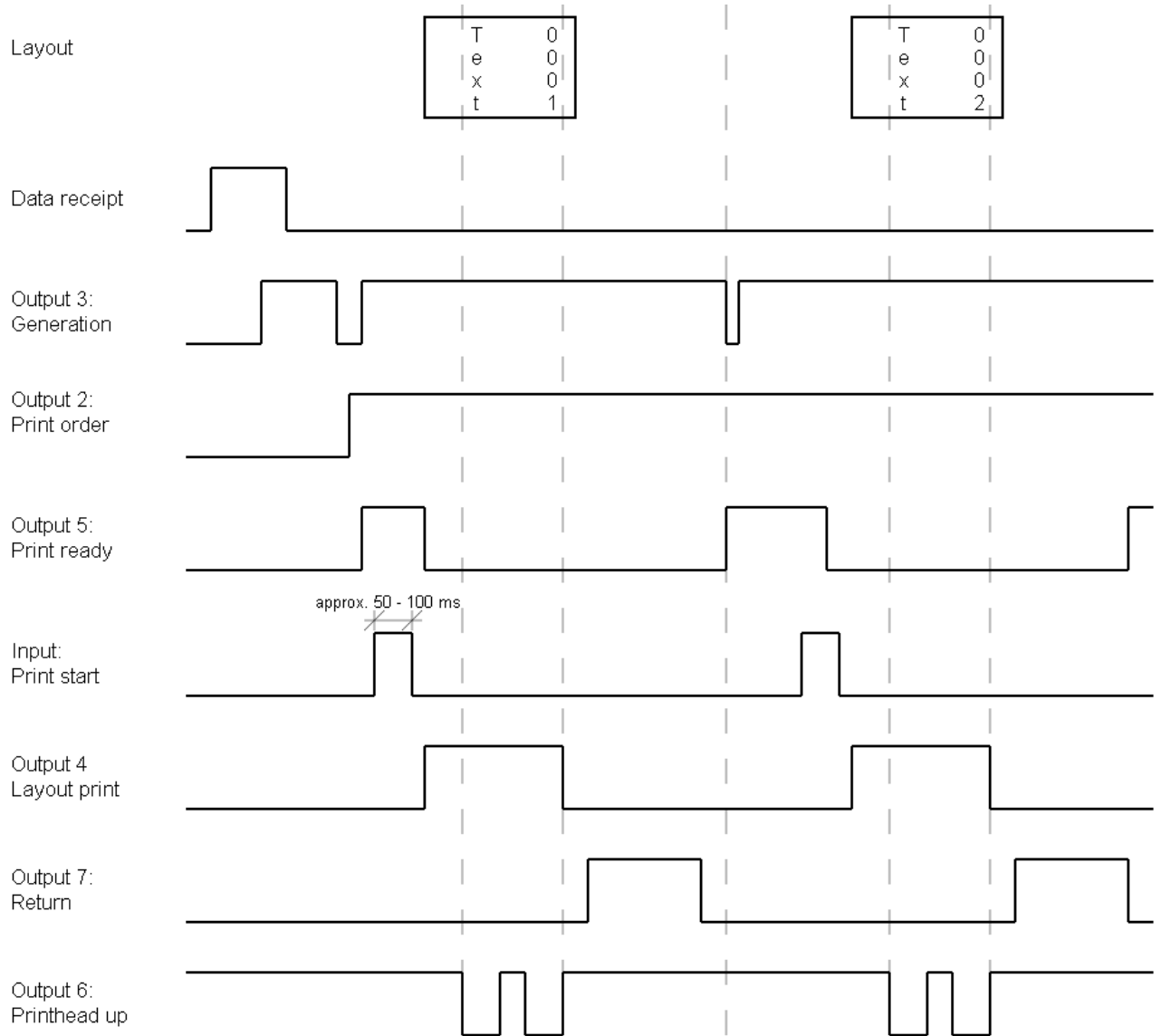

9.4 Mode 8 (single item processing)

Return without 'layout printing' signal

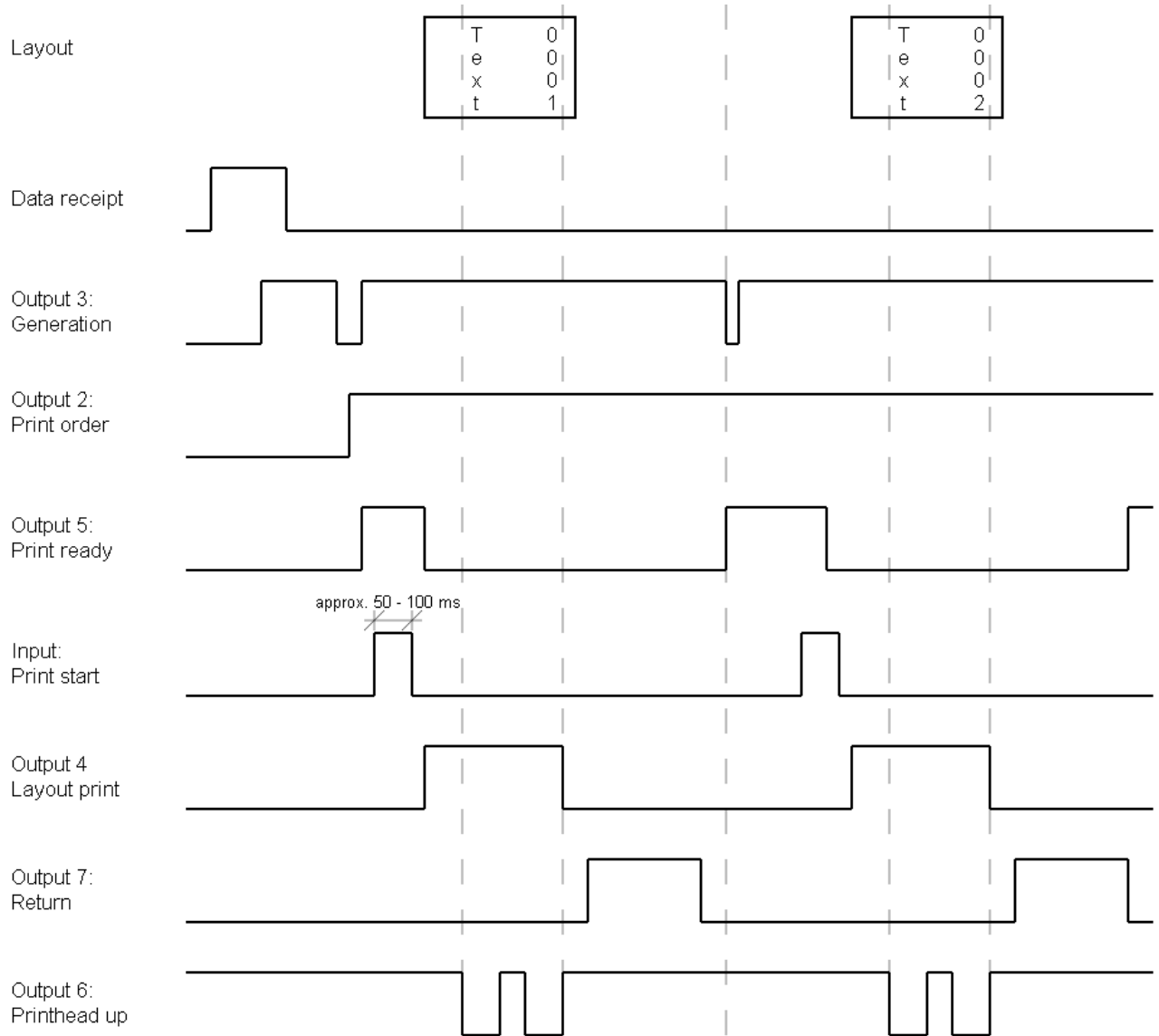

10 Error correction

Error 01 Line too high	Line rises up completely or partly over the upper edge of layout.	Move line down (increase Y value). Check rotation and font.
Error 02 Line too low	Line rises up completely or partly over the bottom edge of layout.	Move line up (reduce Y value). Check rotation and font.
Error 03 Character set	One res. several characters of the text is res. are not available in the selected font.	Change text. Change font.
Error 04 Unknown codetype	Selected code is not available.	Check code type.
Error 05 Illeqal rotation	Selected position is not available.	Check position.
Error 06 Font	Selected font is not available.	Check font.
Error 07 Vector font	Selected font is not available.	Check font.
Error 08 Measuring label	While measuring no layout was found. Set layout length is too large.	Check layout length and if layouts are inserted correctly. Restart measuring anew.
Error 09 No label found	No layout available. Soiled layout photocell. Layouts not inserted correctly.	Insert new layout roll. Check if layouts are inserted correctly. Clean the layout photocell.
Error 10 No ribbon	During the print order the ribbon roll becomes empty. Defect at the transfer ribbon photocell.	Change transfer ribbon. Check transfer ribbon photocell (service functions).
Error 11 COM Framing	Stop bit error.	Check stop bits. Check baud rate. Check cable (printer and PC).
Error 12 COM Parity	Parity error.	Check parity. Check baud rate. Check cable (printer and PC).

Error COM Overrun 13	Loss of data at serial interface (RS-232).	Check baud rate. Check cable (printer and PC).
Error Field number 14	Received line number is invalid at RS-232 and Centronics.	Check sent data. Check connection PC - printer.
Error Length mask 15	Invalid length of received mask statement.	Check sent data. Check connection PC - printer.
Error Unknown mask 16	Transferred mask statement is invalid.	Check sent data. Check connection PC - printer.
Error Missing ETB 17	No end of data found.	Check sent data. Check connection PC - printer.
Error Inv. character 18	One res. several characters of the text is res. are not available in the selected font.	Change text. Change font.
Error Inv. statement 19	Unknown transferred data record.	Check sent data. Check connection PC - printer.
Error Inv. checkdigit 20	For check digit control the entered res. received check digit is wrong.	Calculate check digit anew. Check code data.
Error Illegal SC code 21	Selected SC factor is invalid for EAN res. UPC.	Check SC factor.
Error Inv. no of digit 22	Entered digits for EAN res. UPC are invalid < 12; > 13.	Check number of digits.
Error Type checkdigit 23	Selected check digit calculation is not available in the bar code.	Check calculation of check digit. Check bar code type.
Error Inv. extension 24	Selected zoom factor is not available.	Check zoom factor.
Error Sign of offset 25	Entered sign is not available.	Check offset value.
Error Value of offset 26	Entered offset value is invalid.	Check offset value.

Error 27 Printhead temp.	Printhead temperature is too high. Defective printhead sensing device.	Reduce contrast. Change printhead.
Error 28 Error cutter	With cut an error occurred. Paper jam.	Check layout run. Check cutter run.
Error 29 Inv. parameter	Entered data do not correspond to the characters allowed from the application identifier.	Check code data.
Error 30 Appl. Identifier	Selected application identifier is not available in GS1-128 (EAN 128).	Check code data.
Error 31 HIBC Definition	F Missing HIBC system sign. Missing primary code.	Check definition of HIBC code.
Error 32 System clock	Real Time Clock function is selected but the battery is empty. Defective RTC.	Change battery. Change RTC component.
Error 33 No interface	Interrupted connection CPU - memory card. Defective memory card interface.	Check connection CPU - memory card interface. Check memory card interface.
Error 34 No print memory	No print memory found.	Check memory assembly on CPU.
Error 35 Cover open	At start of a print order the printhead is open.	Close the printhead and start print order anew.
Error 36 BCD inv format	BCD error Invalid format for the calculation of Euro variable.	Check entered format.
Error 37 BCD Overflow	BCD error Invalid format for the calculation of Euro variable.	Check entered format.
Error 38 BCD Division	BCD error Invalid format for the calculation of Euro variable.	Check entered format.
Error 39 FLASH Error	Flash component error.	Run a software update. Change CPU.

Error 40 Length command	Invalid length of the received command statement.	Check data sent. Check connection PC - printer.
Error 41 No drive	Memory card not found / not correctly inserted.	Insert memory card correctly.
Error 42 Drive error	Impossible to read memory card (faulty).	Check memory card, if necessary change it.
Error 43 Not formatted	Memory Card not formatted.	Format memory card.
Error 44 Delete act. dir.	Attempt to delete the actual directory.	Change directory.
Error 45 Path too long	Too long indication of path.	Indicate a shorter path.
Error 46 Drive WP	Memory Card is write-protected.	Deactivate write protection.
Error 47 Dir. not file	Attempt to indicate a directory as file name.	Correct your entry.
Error 48 File alrdy open	Attempt to change a file during an access is active.	Select another file.
Error 49 No file/dir	File does not exist on memory card.	Check file name.
Error 50 Invalid filename	File name contains invalid characters.	Correct entry of name, remove special characters.
Error 51 Int. file error	Internal file system error.	Please contact your distributor.
Error 52 Root full	The max. number (64) of main directory entries is reached.	Delete at least one main directory entry and create subdirectories.
Error 53 Drive full	Maximum memory capacity is reached.	Use new Memory Card, delete no longer required files.

Error 54 File/dir exists	The selected file/directory already exists.	Check name, select a different name.
Error 55 File too large	During copying procedure not enough memory space onto target drive available.	Use a larger target card.
Error 56 No update file	Errors in update file of firmware.	Start update file anew.
Error 57 Inv. graph. file	The selected file does not contain graphic data.	Check file name.
Error 58 Dir not empty	Attempt to delete a not empty directory.	Delete all files and sub-directories in the desired directory.
Error 59 No interface	No memory card drive found.	Check connection of memory card drive. Contact your distributor
Error 60 No card	No memory card is inserted.	Insert memory card in the slot.
Error 61 Webserver error	Error at start of web server.	Please contact your distributor.
Error 62 Wrong PH-FPGA	The direct print module is equipped with the wrong FPGA.	Please contact your distributor.
Error 63 End position	The layout length is too long. The number of layouts per cycle is too much.	Check layout length res. the number of layouts per cycle.
Error 64 Zero point	Defective photocell.	Change photocell.
Error 65 Compressed air	Pressure air is not connected.	Check pressure air.
Error 66 Ext. release	External print release signal is missing.	Check input signal.
Error 67 Row too long	Wrong definition of column width res. number of columns.	Reduce the column width res. correct the number of columns.

Error Scanner 68	The connected bar code scanner signals a device error.	Check the connection scanner/printer. Check scanner (dirty).
Error Scanner NoRd 69	Bad print quality. Printhead completely soiled or defective. Print speed too high.	Increase contrast. Clean printhead or exchange (if necessary). Reduce print speed.
Error Scanner Data 70	Scanned data does not correspond to the data which is to print.	Exchange printhead.
Error Invalid page 71	As page number either 0 or a number > 9 is selected.	Select a number between 1 and 9.
Error Page selection 72	A page which is not available is selected.	Check the defined pages.
Error Page not defined 73	The page is not defined.	Check the print definition.
Error Format user quid 74	Wrong format for customised entry.	Check the format string.
Error Format date/time 75	Wrong format for date/time.	Check the format string.
Error Hotstart MC 76	No memory card found.	If option hotstart was activated, a memory card must be inserted. Switch off the printer before inserting the memory card.
Error Mirror/Rotate 77	Selection of print of several columns and also mirror/rotate.	It is only possible to select one of both functions.
Error System file 78	Loading of temporary hotstart files.	Not possible.
Error Shift variable 79	Faulty definition of shift times (overlapping times).	Check definition of shift times.
Error RSS Code 80	General RSS bar code error.	Check definition and parameter of RSS bar code.

Error 81 IGP error	Protocol error IGP.	Check sent data.
Error 82 Time generation	Printing creation was still active at print start.	Reduce print speed. Use printers' output signal for synchronisation. Use bitmap fonts to reduce generating time.
Error 83 Transport prot.	Both DPM position sensors (start/end) are active.	Displace zero point sensor Check sensors in service functions menu
Error 84 No font data	Font and web data is missing.	Run a software update.
Error 85 No layout ID	Layout ID definition is missing.	Define layout ID onto the layout.
Error 86 Layout ID	Scanned data does not correspond to defined ID.	Wrong layout loaded from memory card.
Error 87 RFID no label	RFID unit cannot recognise a layout.	Displace RFID unit or use an offset.
Error 88 RFID verify	Error while checking programmed data.	Faulty RFID layout. Check RFID definitions
Error 89 RFID timeout	Error at programming the RFID layout.	Layout positioning. Faulty layout.
Error 90 RFID data	Faulty or incomplete definition of RFID data.	Check RFID data definitions.
Error 91 RFID type	Definition of layout data does not correspond with the used layout.	Check storage partitioning of used layout type
Error 92 RFID lock	Error at programming the RFID layout (locked fields).	Check RFID data definitions. Layout was already programmed.
Error 93 RFID program.	Error at programming the RFID layout.	Check RFID definitions.

Error 94 Scanner timeout	The scanner could not read the bar code within the set timeout time. Defective printhead. Wrinkles in transfer ribbon. Scanner wrong positioned. Timeout time too short.	Check printhead. Check transfer ribbon. Position scanner correctly, corresponding to the set feeding. Select longer timeout time.
Error 95 Scan layout diff	Scanner data does not correspond to bar code data.	Check adjustment of scanner. Check scanner settings / connection.
Error 96 COM break	Serial interface error.	Check settings for serial data transmission as well as cable (printer-PC).
Error 97 COM general	Serial interface error.	Check settings for serial data transmission as well as cable (printer-PC).
Error 98 No SW PH-FPGA	No printhead-FPGA data available.	Please contact your responsible distributor.
Error 99 Load SW PH-FPGA	Error when programming printhead-FPGA.	Please contact your responsible distributor.
Error 100 Upper position	Sensor signal up is missing (option APL 100).	Check input signals / compressed-air supply.
Error 101 Lower position	Sensor signal down is missing (option APL 100).	Check input signals / compressed-air supply.
Error 102 Vac. plate empty	Sensor does not recognise a label at vacuum plate (option APL 100).	Check input signals / compressed-air supply.
Error 103 Start signal	Print order is active but device not ready to process it.	Check start signal.
Error 104 No print data	Print data outside the defined layout. Selection of wrong module type (design software).	Check selected module type. Check selection of left/right version.

Error Printhead	105	No original printhead is used.	Check the used printhead. Contact your distributor.
Error Invalid Tag type	106	Wrong Tag type. Tag data do not match the Tag type in the printer.	Adapt data or use the correct Tag type.
Error RFID inactiv	107	RFID module is not activated. No RFID data can be processed.	Activate RFID module or remove RFID data from label data.
Error GS1-128 invalid	108	Transferred GS1-128 (EAN 128) bar code is invalid.	Verify bar code data (see GS1-128 bar code specification).
Error EPC Parameter	109	Error at EPC calculation.	Verify data (see EPC specification).
Error Housing open	110	When starting the print order the housing cover is not closed.	Close the housing cover and start the print order anew.
Error EAN.UCC Code	111	Transferred EAN.UCC code is invalid.	Verify bar code data (see corresponding specification).
Error Print carriage	112	Printing carriage does not move.	Check gear belt (possibly broken).
Error Applicator error	113	Applicator error.	Check applicator.
Error Left position	114	Applicator Left end position	Check LEFT final position switch for correct function and position. Check function of pneumatics for cross traverse.
Error Right position	115	Applicator: Right end position	Check RIGHT final position switch for correct function and position. Check function of pneumatics for cross traverse.
Error Print position	116	Applicator: Not in print position	Check TOP and RIGHT final position switch for correct function and position. Check function of pneumatics.
Error XML Parameters	117	Parameter error XML file.	Please contact your responsible distributor.

11 Additional information

11.1 Column printing

With this direct print module several columns can be printed, i.e. the information of one column can be printed several times (depending on its width) on a layout. Caused by this the use of the complete print width is possible and the generating time is enormously reduced.

For example 4 columns with a width of 25 mm or 2 columns with a width of 50 mm can be printed onto a layout with a width of 100 mm. Please note that the first layout is always the one with the largest x coordinate, i.e. it has the largest distance to the printhead.

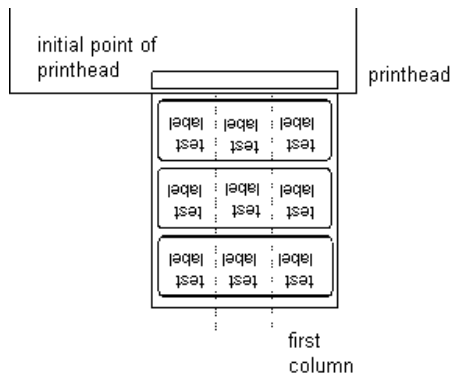

Setting the print of several columns

```
Width:      20.0
Columns:    4
```

Press key **F** to change to the function menu.

Press key **▲** as long as to the 'Layout' menu.

Press key **●** to confirm the selection.

Press key **▲** as long as the menu item (see illustration) appears.

Press key **▲** and **▼** to set the layout width. As column width the width of one layout is entered, e.g. 20.0 mm.

Press key **◀** and **▶** to enter the number of columns.

Press key **▲** and **▼** to change the number of columns, e.g. 4 columns at a layout width of 20.0 mm.

Press key **□** to start a print with indication of number of layouts and number of lines. The number of layouts corresponds to the number of layouts that are to print.

e.g. columns: 3, items: 4



The first four layouts were printed but not layout 5 and 6.

11.2 Password

Example 1

The supervisor programs a Compact Flash memory card directly with the direct print module. He stores 10 different layouts. As well he adjusts the printer parameters, like contrast, speed, etc. to the corresponding values. The user is only supposed to read the layouts from memory card and to print them. Therefore the supervisor blocks the function menu and the entry function by a password.

Example 2

The printer is connected to a PC. The user is only supposed to take the layouts dispensed by the printer and stick them on. To prevent, that the layouts or the printer set-up will not be changed, the supervisor blocks all printer functions (e.g. function menu, entry menu, etc.) by a password.

Example 3

The user has to change several texts before printing. It is not allowed to change any masks (fonts, position, etc.). Therefore the supervisor blocks the entry of mask and the function menu. By this means the user indeed can print layouts, but the printer set-up and the masks of the layouts can't be changed.

To receive a most flexible password protection, the printer functions will be divided into several function groups:

1. Function menu

In the function menu the printer parameters can be changed (contrast, speed, mode, ...). The password protection prevents modifications at the printer settings.

2. Compact Flash card

With the functions of your Compact Flash card layouts can be stored, loaded,

Here the password protection has to separate, if none or only reading functions are allowed.

3. Print functions

With key quant a print can be produced. In case the printer is connected to a PC, it can be useful, that the user is not able to produce a print manually. So the password protection prevents that prints can be produced manually.

Because of these different function groups the password protection is very flexible. The printer can be adjusted best to its actual order, as only certain functions are blocked.

Password definition

In case no password is defined res. the password protection is not activated, all functions can be used. In the function menu you will find the menu item "Password", where the password can be entered and the password protection activated.

Press key  as long as to the password menu.

Press key  to confirm the selection.

```

Password 0000 J
F:0 MC:0 D:0

```



Meaning of abbreviations:

F Function menu
 CF Compact Flash card functions
 D Print functions

In case the password protection is active, but the function menu is not protected, the password



(4-digit number between 0000 and 9999) has to be entered first, so the above shown display appears. Now changes can be done. In the first line the user can define the password (4-digit number).

Press key  to continue.

Press key  and  to activate/deactivate the password protection (yes/no).

Press key  to change to the second line.

Press key  and  to block/release individual function groups.

Press key  and  to change from one group to the next one.

F:	Function menu	0...open 1...locked
CF:	Compact Flash card	0...open 1...only reading access 2...access blocked
D:	Printer guiding	0...open 1...open 2...no manual print release

Activate blocked function

In case the user wants to perform a blocked function, he has to enter the valid password first.

```

Password Prot.
0000

```

The entered password has to be confirmed with E. In case the correct password has been entered the desired function can be performed. If the entered password was invalid no error message appears but the main menu will be displayed.

11.3 Hotstart



Because of the fact that no battery-buffered SRAM is available, the necessary data has to be saved in another way, i.e. the data is saved onto Compact Flash card. Therefore the option Compact Flash card is a condition for the hotstart menu item.

The function hotstart contains e.g. that in case of a power failure the currently loaded layout can be further processed without any loss of data.

Moreover a print order can be interrupted and to be continued after switching on the printer anew.



At an active hotstart all necessary data is stored on the Compact Flash therefore do not remove the card during operation. When removing during operation, this causes the loss of all data on the Compact Flash Card.

Saving the current layout

In case the hotstart function is set to on, at the start of a print order the data of the current layout is saved to the corresponding directory of the Compact Flash card.

However the following conditions have to be fulfilled:

- Compact Flash card inserted in drive A
- Compact Flash card not write protected
- Enough free storage space onto Compact Flash card

An error message appears in case these conditions are not fulfilled.

Saving the printer order state

At switching off the printer the state of the current print order is saved to the corresponding directory of the Compact Flash Card.

However the following conditions have to be fulfilled:

- Compact Flash card inserted in drive A
- Compact Flash card not write protected
- Enough free storage space onto Compact Flash card

Loading a layout and printer order state

In case the hotstart function is set to On, at a new start of printer the saved layout data and the print order state is loaded from the corresponding file on the Compact Flash card. Because of this reason a Compact Flash card has to be inserted at switching on the printer. In case it is impossible to load the data an error message appears.

Starting the print order

In case at switching off the direct print module a print order was active, then a print start is released automatically and the required res. actual number of printed layouts is refreshed.

In case the print order was stopped at switching off the direct print module, it is again set to the stopped mode after switching on the direct print module anew.

In case a customized entry was active during switching off the direct print module, the window for the first customized variable is displayed.

Refreshing the variable counter

As in the intended file only the start values of the counter are saved, they are refreshed at a new start of the print order by means of the number of printed layouts. Each counter is counted corresponding from its start value. Afterwards the position of the current and the next counter update are correctly set by means of the update intervals.



Make sure that in case graphics are onto the layout they have to be saved onto Compact Flash card.

12 Index

C

Column printing	83
Compact Flash card	57, 58, 59, 60
Connection	29

D

Delivery scope	25
----------------------	----

E

Environmentally-friendly disposal	6
Error correction	73, 74, 75, 76, 77, 78, 79, 80, 81

F

Figures	6, 7
Function menu	
Date/time	52
Device settings	46, 47
Emulation	51
I/O parameters	48, 49
Interface	50
Layout settings	44
Machine parameters	40, 41, 42, 43
Menu structure	37, 38
Network (option)	49
Print settings	39
Remote console	49
Ribbon save	45
Service functions	53, 54

H

Hotstart	86, 87
----------------	--------

I

Important notes	5
Initiation	30
Initiation, preparations	29
Inputs/outputs	16, 17, 18, 19, 20, 21, 22, 23
Installation at machines	26
Intended use	5

K

Keyboard	
Standard	33
Text entry/customized entry	34, 35

M	
Main menu.....	55
Maintenance/cleaning	
Angle adjustment.....	64
Cleaning printhead.....	61
Cycle optimisation.....	67
Print quality optimisation.....	66
Replacing printhead.....	61, 62
Transfer ribbon tension.....	63
Zero point adjustment.....	65
O	
Operating conditions	10, 11, 12, 13
P	
Password protection.....	84, 85
Plug & Play.....	24
Pneumatic power supply, connection.....	27
Print control	30
Print principle.....	8
S	
Safety notes	9
Signal diagram	
Mode 1 (single item processing).....	69
Mode 2 (continuous mode).....	70
Mode 4 (continuous mode, return without 'layout printing' signal) .	71
Mode 8 (single item processing, return without 'layout printing' signal).....	72
T	
Technical data	15
Transfer ribbon loading	31
U	
Unpacking.....	25
W	
Warnings	9