

Aircode™ ID AC-100

Upgrade the ventilation system!

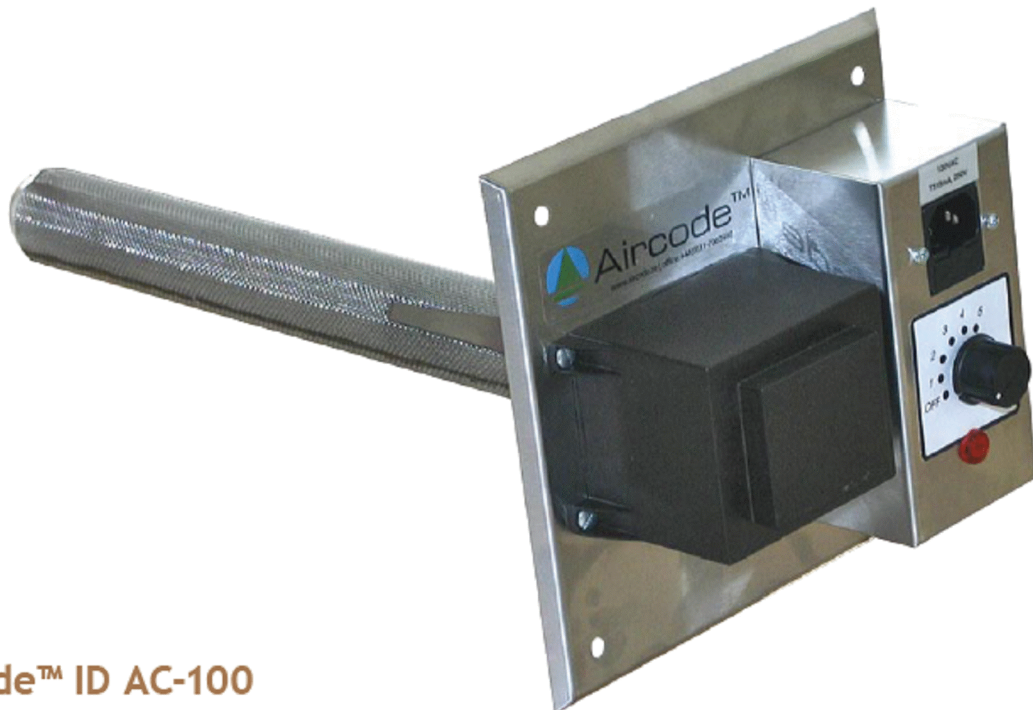

Aircode™ ID AC-100

Aircode™ ID AC-100 air purification system ionization unit information and easy ventilation system instructions. This unit cleans the air envelope environment contained within average sized home HVAC systems and can also be applied for commercial and industrial use applications. The unit is custom-fitted and is the smallest in-duct unit within the Aircode™ product line. The Aircode™ ID AC-100 eliminates odors, bacteria, airborne microbes, gases, mold, and fungus spores. The unit contains one ionization tube that lasts 9000 operating hours. It also has a five-step adjustment switch to control ion output.

Technical data ID AC-100

Location: Installed within the ventilation system

Voltage: 120V, 50-60 Hz

Number of tubes: 1

Size of tube: 30 (13.78")

Energy consumption: 10 watt

Weight: 2 kg (4.4 lbs)

Size: h: 7.48", w: 7.48", L: 3.11"

Capacity: Handles airflows up to 1500 m³/hour

Applications: Smaller (or branches of the) ventilation system in: homes, offices, clean rooms, factories, sewage facilities, etc.

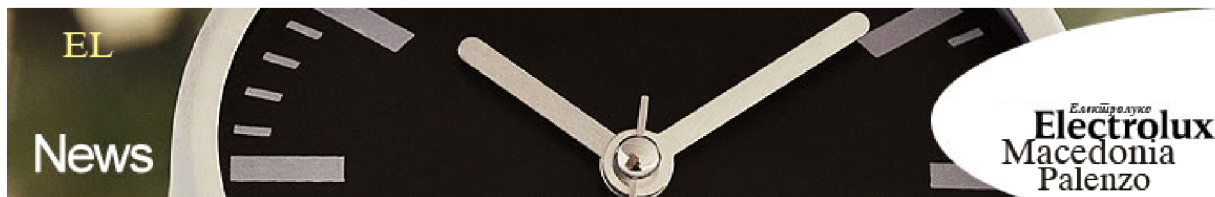

Intended use

Warning! The ID AC-100 air purification system is intended for installation within duct systems only. The system should not be installed outside of duct systems, since bodily contact with the high voltage ionization tube is extremely dangerous.

Equipment inspection

- Carefully remove the equipment from the shipping carton. Verify that the ID AC-100's voltage is the same as available voltage by checking the voltage label on the ID AC-100.
- Inspect the ionization tube for damage by making sure there are no cracks in the glass ionization tube; the black plastic end cap is securely fastened on the end of the tube; the wire mesh sock fits snugly over the tube and, that the threads on the stud protruding from the end of the black end cap are not worn or stripped.

Mechanical installation

- Screw the ionization tube into the ID AC-100. *fig 1*

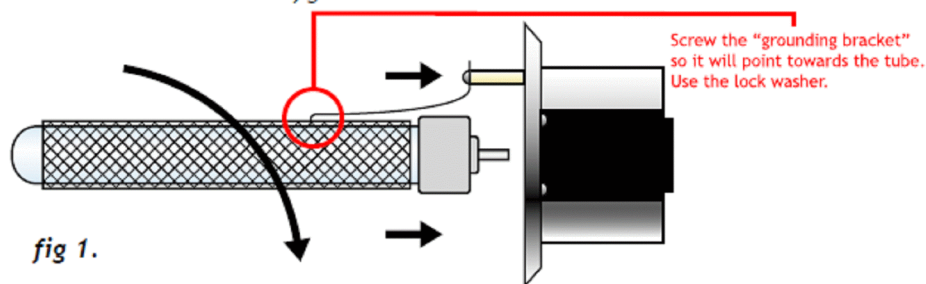

- Trace a 3.15" by 3.937" square on the surface of the duct onto which you are mounting the ID AC-100. *fig 2*

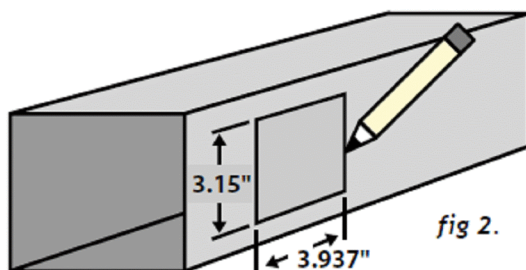

- Cut out the traced portion of the duct using snips or sheet metal cutters. *fig 3*

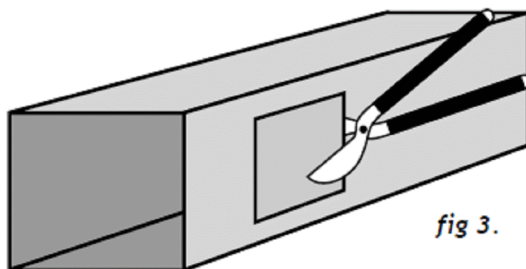

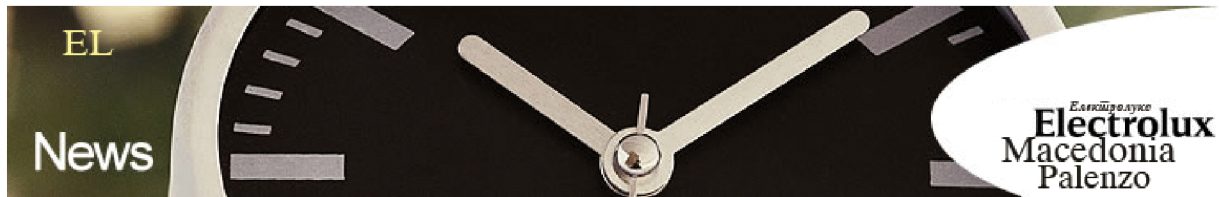

6. Screw the ID AC-100 onto the the duct using the supplied sheet metal screws. *fig 4*

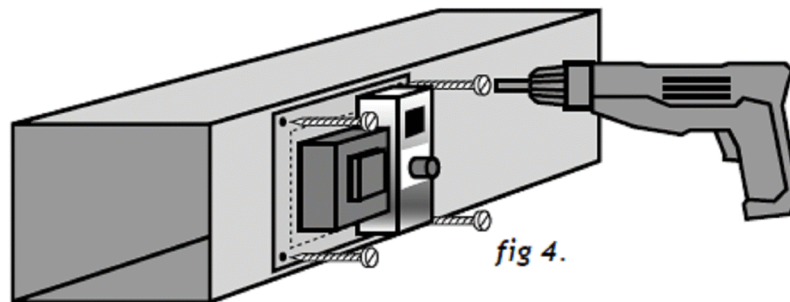

Electrical installation

**Warning! The secondary voltage to the ionization tube is 3000 volts!
DO NOT CONNECT THE ID AC-100 TO POWER BEFORE THE MECHANICAL INSTALLATION IS COMPLETE.
ALWAYS DISCONNECT POWER TO THE ID AC-100 BEFORE HANDLING ANY OF ITS COMPONENTS!**

8. Make sure the ID AC-100 is interfaced on the same electric line as the supply fan or, an air pressure switch has been installed.

**IMPORTANT: The ID AC-100 must ONLY operate while within a continuous air flow.
DO NOT operate without continuous air flow.**

9. Check local electric codes to ensure the enclosed 20 amp rated power cord is suitable for installation at this facility or home

10. Internal fuses protect the ID AC-100. Be sure that the maximum circuit amperage supplying the unit does not exceed 20 amps since the internal fuse protecting the ID AC-100 only has 20 amps maximum amperage.

Ionization setting

11. Set the ionization at level three (3) using the knob on the front of the unit. Check the ionization level in the occupied zone with an ion meter. The ionization level should be between 500 and 1500 ions/cm³. Return to the installation in two or three days to confirm that the ion levels are within this range. If the ion level is not in the desired range; adjust the ionization level control knob accordingly.

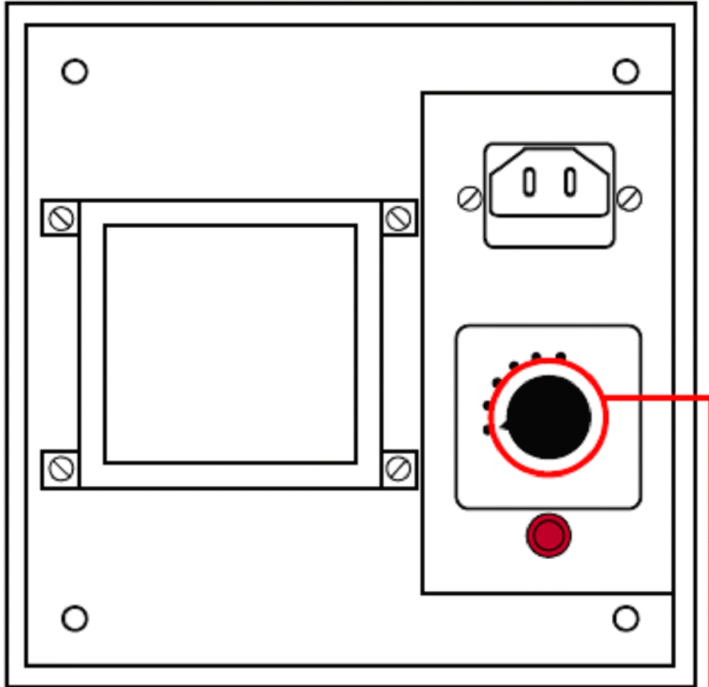

Ionization Level Control Knob

