

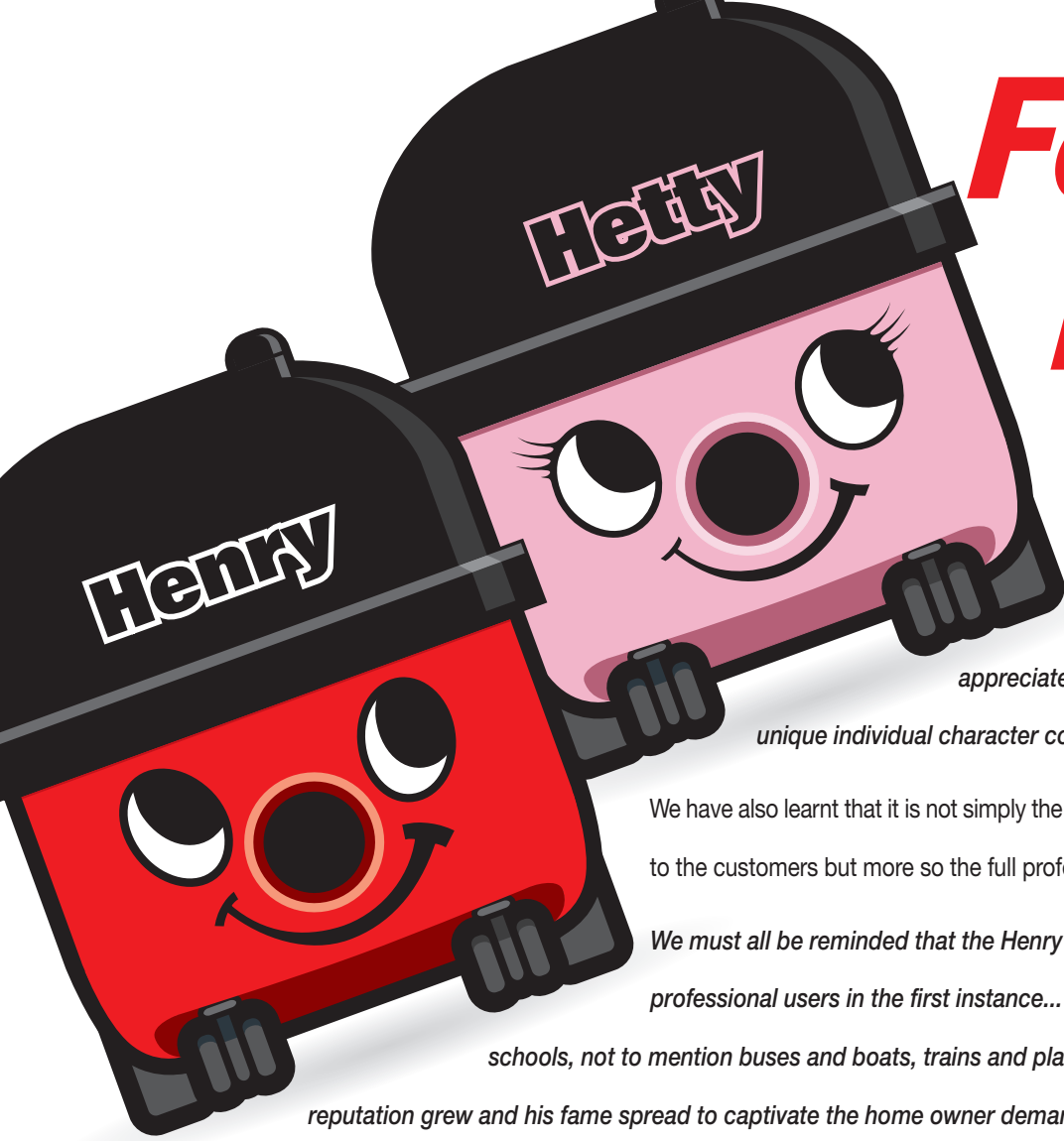

Homecare



Face to Face...

With the introduction of Henry with his happy but cheeky little smile more than 25 years ago, we have now come to truly understand just how much our customers appreciate, or dare we say in some cases love, the unique individual character concept.

We have also learnt that it is not simply the character that has endeared the Henry product to the customers but more so the full professional specification of the machine's design.

We must all be reminded that the Henry machine and concept was created for professional users in the first instance... being used in hospitals, hotels, shops and schools, not to mention buses and boats, trains and planes and it was from this beginning that his reputation grew and his fame spread to captivate the home owner demanding long life and improved performance.

Our daily lives are inundated with a whole range of inanimate appliances, the washing machine, dishwasher, cooker, refrigerator and we certainly could not be without them. But then there is Henry... not forgetting Hetty, James, Charles and George... out they come, a smile at every turn that really does say "Come on, let's get the job done together, it won't take long!" Be it cleaning the house, the car, the carpets or clearing out the loft, with one look that happy little smile lets you know that it's all under control.

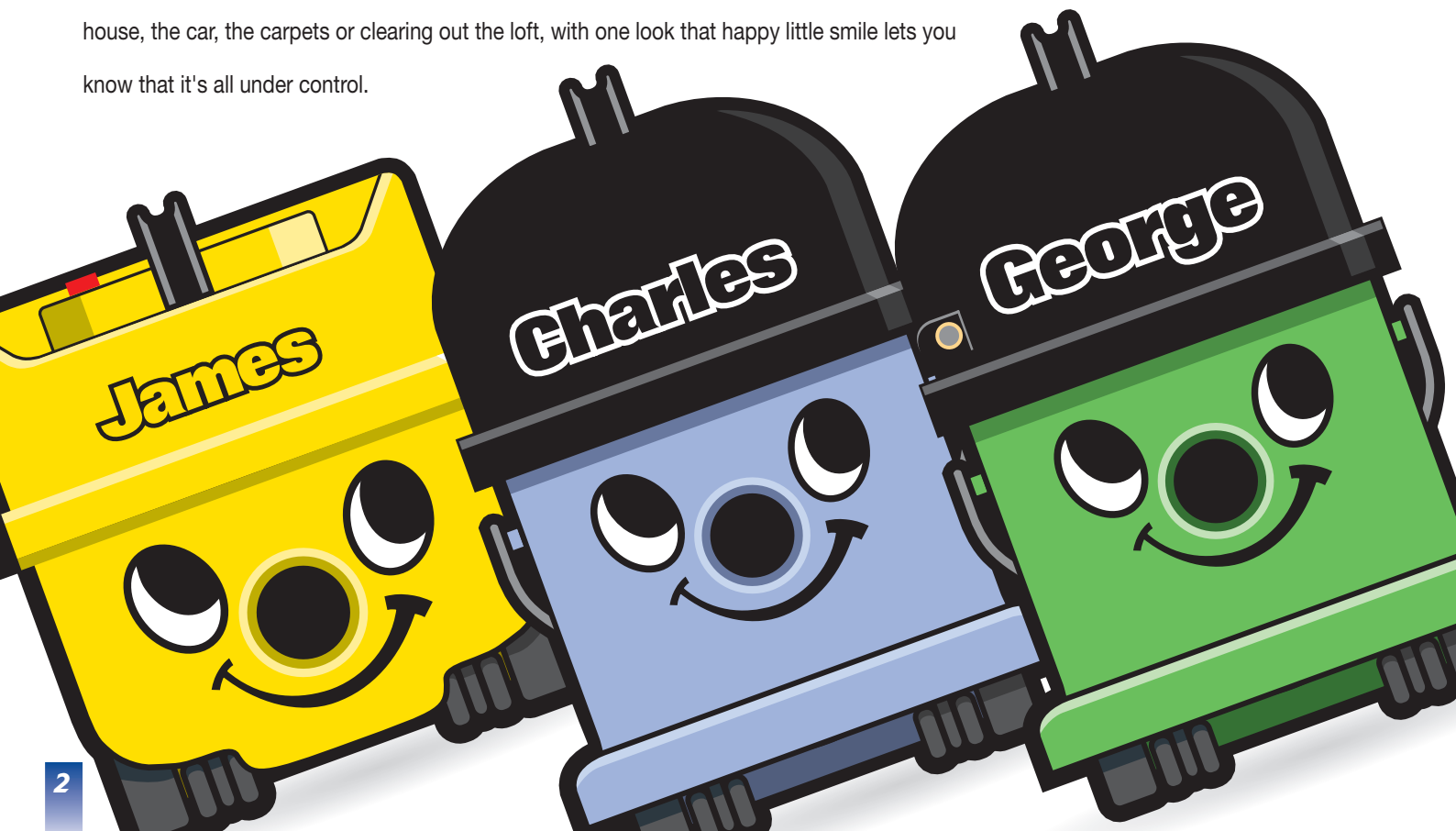



James *JVP180*

James is not only a classic with personality plus, but he's also a very clever design based on genuinely thoughtful simplicity coupled with superb power and performance.

The on switch is my master control, it's bright red so you can't miss it, but once used, get ready to be impressed... we're talking professional standards now! The unique caddy

top is brilliant... somewhere for your cable, the tools and even a duster and some polish... right where you need them, when you need them - every time. Even the cable is securely plugged to the machine allowing easy replacement should it accidentally become damaged.

Big capacity, four wheel stability, giant filters coupled with two stage Microflo' dust bags give you the very best of all worlds, quick and efficient to use, simple to empty.

Accessories are to full professional size and specification... nothing skimped... nothing forgotten. Designed to do the job and do it well, wherever, whenever.

James, a simple design that started where most others stopped.

Motor	Power	Airflow	Suction	Capacity	Range	Weight	Dimensions
1100W	230V AC 50/60Hz	40 L/sec	2200mm	8L	26.8m	5.2Kg	340 x 340 x 340mm

Also available in 115V/120V specification. For additional accessories see page 14



Henry *HVR200-22*

Full Twinflo' two-stage professional motor giving exceptional performance; Hi-Lo operation allows different power to meet different surfaces and applications, also reducing sound levels for sensitive areas. The 10-metre cable storage and rewind system is a work of art, trouble free and spring free, and it keeps everything neat and tidy. The giant Tritex



filter system makes sure that what goes in stays in, and giant Microflo' dust bags are really clean and easy for emptying.

The standard accessory kit is fully comprehensive and even some of the tools are stainless steel.

Twinflo'

A true professional in every sense of the word but never without that famous smile, loved and appreciated by users the world over... ask any Henry owner.

Motor	Power	Airflow	Suction	Capacity	Range	Weight	Dimensions
1200W	230V AC 50/60Hz	45 L/sec	2600mm	9L	26.8m	6.9Kg	340 x 340 x 370mm

Also available in 115V/120V specification. For additional accessories see page 14



Hetty HET200-22

Hetty (short for Henrietta) is not just a pretty face, she has all the Henry features and specification: giant twinflo', long life, 2-stage motors; 2-speed Hi/Lo controls allowing a



20% energy saving together with improved low noise levels during operation; high efficiency filtration; in fact, if Henry's got it, so has Hetty, but now she will even flutter her eyelashes!

Twinflo'

Like Henry himself, Hetty has a comprehensive, high performance, long life, accessory kit and a full range of optional accessories which add even further to its versatility.

Now you have a choice of machine, Henry or a girl Henry called Hetty.

Motor	Power	Airflow	Suction	Capacity	Range	Weight	Dimensions
1200W	230V AC 50/60Hz	45 L/sec	2600mm	9L	26.8m	6.9Kg	340 x 340 x 370mm

Also available in 115V/120V specification. For additional accessories see page 14



Henry Xtra HVX200-22

Henry Xtra is in every way a true Henry with its full professional specification, Twinflo' performance; Hi-Lo operation and 10-metre cable rewind system.

What makes Henry Xtra truly different is the addition of two unique features:-



The 3-stage Microfresh filter system enhances filtration standards to 98%, but more importantly - especially to pet owners - it embodies a giant activated charcoal filter membrane sandwiched between twin Tritex filters, providing an effective odour control system.

Twinflo'

To the comprehensive accessory kit has been added our unique Airo power brush providing a superb level of carpet care which, again, will be well received where pets are an important part of the family.

Whether you are a Home Owner or a Pet Owner, or both, the Henry Xtra with his cheeky little smile will equally bring a smile to your face. Cleaning has just never been this good.

Motor	Power	Airflow	Suction	Capacity	Range	Weight	Dimensions
1200W	230V AC 50/60Hz	45 L/sec	2600mm	9L	26.8m	6.9Kg	340 x 340 x 370mm

Also available in 115V/120V specification. For additional accessories see page 14

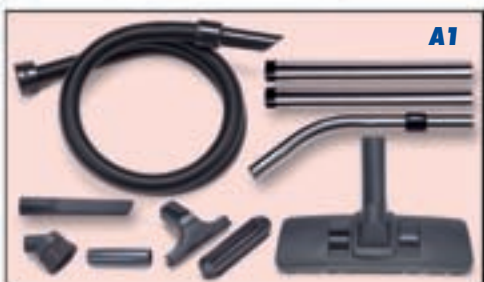
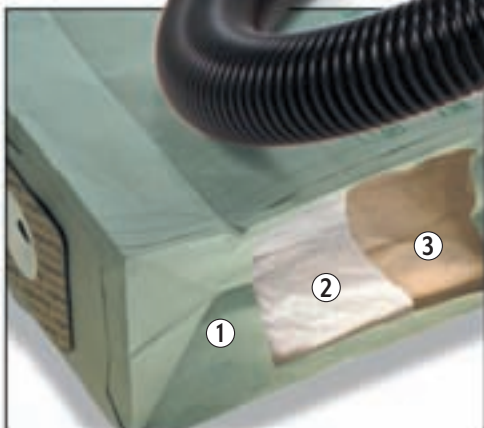

Henry Micro *HVR200M-22*

There are Henrys here and Henrys there, you'll find dear Henry everywhere, but so will you find dust related allergies; purported to affect between 20% and 30% of the population, especially the very young and the elderly.



Henry Micro is to the full Henry specification with the professional Twinflo' vacuum motor, Hi-Lo control for different surface applications, a 10-metre cable rewind and storage system: but to this has been added our exclusive Microtex filtration system approved to the highest allergen standard by the British Allergy Foundation.

In every way fast and friendly, never without his cheeky smile, Henry Micro comes to the aid of sufferers everywhere.

REMEMBER you can always add a Microtex filter to any standard Henry to upgrade filtration to this exceptional standard, if required.

Motor	Power	Airflow	Suction	Capacity	Range	Weight	Dimensions
1200W	230V AC 50/60Hz	45 L/sec	2600mm	9L	26.8m	6.9Kg	340 x 340 x 370mm

Also available in 115V/120V specification. For additional accessories see page 11.



Henry Turbo *HVR200T-2*

Again, the Henry Turbo embodies all the unique Henry features, including his famous smile but to the professional specification has been added two exceptional additional features:-



Twinflo'

The Microfresh filtration system - Micro being 98% efficient and fresh by virtue of a giant activated charcoal filter membrane, sandwiched between twin Tritex filters, providing a high degree of odour control.

The Turbo Electric Power Brush system is truly unique with its 24 volt floating, self-adjusting power brush design and removable brush roll for easy cleaning.

Added to this is a whole host of standard additional accessories to cover the full range of cleaning tasks.

Without doubt Henry Turbo is a serious model for extensively carpeted homes and also for pet owners, raising the overall cleaning standard to a new improved level.

Motor	Power	Airflow	Suction	Capacity	Range	Weight	Dimensions
1200W	230V AC 50/60Hz	45 L/sec	2600mm	9L	26.8m	7.3Kg	340 x 340 x 370mm

Also available in 115V/120V specification. For additional accessories see page 14



A21A



Charles CVC370-2

You want a vacuum cleaner that is totally without compromise, be it for wet or dry use, and that's exactly what you get. One minute (or most of the year in the majority of cases) Charles will be up to his neck in dust and dirt, keeping everything spick and span, and then suddenly the call arrives and he's expected to unblock the sink or dry the floor.



Twinflo'

Well, it's no problem with Charles, he has our full Twinflo' motor and performance to give you exactly what you need.

Big filters and disposable dust bags for dry use and a safety float valve for wet pick-up.

Tubes are lightweight aluminium and will never rust. Two floor nozzles, one for wet work and a superb combination nozzle for carpets and hard floors, and even that has a stainless steel high efficiency carpet plate. Add to this three smaller tools and you are ready to tackle almost anything that comes along, be it floors or floods, corners or curtains, you are in control.

Having a Charles about the house is like having an insurance policy but without the small print.

Motor	Power	Airflow	Suction	Dry	Wet	Range	Weight	Dimensions
1200W	230V AC 50/60Hz	40 L/sec	2500mm	15L	9L	26.8m	7.1Kg	355 x 355 x 500mm

Also available in 115V/120V specification. For additional accessories see page 15



A26A



George *GVE370-2*

The true "all in one" machine that is totally at home be it in the wet or the dry. This classic "all in one" is genuinely the family friend, dry vacuuming, wet vacuuming, scrubbing and drying hard floors, deep cleaning the carpet, cleaning the upholstery, unblocking the sink, you name it, George is your man.



Twinflo'

The combination of our highly efficient Twinflo' bypass vacuum motor and our powerflo' pump system provides you with professional cleaning standards, any time, anywhere, ensuring exceptional results.

The George design is in itself based entirely on our Cleantec professional range of machines; designed to work extensively and for long hours and functioning to a professional standard.

When it comes to dry vacuuming you have big filters, use of disposable Microflo dust bags, and you have a superb combination floor nozzle. In the wet mode, a simple exchange of the dry filter for the safety float valve allows any number of wet tasks to be achieved.

So there you have it wet, dry, carpets, hard floors, upholstery, you name it, George is your man.

Motor	Power	Airflow	Suction	Wet Capacity	Dry Cap.	Extraction Capacity	Range	Weight	Dimensions
1200W	230V AC 50/60Hz	40 L/sec	2500mm	9L	15L	6L	26.8m	8.8Kg	355 x 355 x 500mm

Also available in 115V/120V specification. For additional accessories see page 15

Henry Spray Mop



Hand spray operation



Dispenser mounting



400ml liquid container



Clicks into place



Foot spray operation

The Henry Spraymop combines all the real advantages of Microfibre floor mops and can be used dry or wet, with or without cleaning agents or disinfectant. Our onboard liquid dispenser, foot or hand operated, ensures that the mop head

can be maintained in a damp condition at all times allowing larger surfaces to be thoroughly cleaned without the use of a bucket.

In this day and age there is a vast range of hard floor surfaces: quarry tiles, PVC tiles, linoleum and now a vast range of laminate surfaces all of which need a fast and friendly means of maintenance.



Cleans 'Hard Floors' like no Henry has ever cleaned before.

Standard Retention Microfibre

Henry and the Henry Mop – The Perfect Team!

A good floor needs to be clean and look clean, on that I think we can all agree!

The Henry Spraymop is like Henry himself, born of the professional market, used extensively for spot cleaning and maintenance in hotels, restaurants, shops and offices and the like, where cleanliness and looking well cared for is all important!

This is genuinely floor maintenance taken into the 21st century with a single leap. With a full 40cm cleaning width you will never look back ... and floors will never look better.

Model	Bottle	Pad	Weight	Size
HM40	400ml	40cm	1Kg	1400mm

Homecare Optional Accessories

Each model within the Homecare has its own unique specification but, by virtue of our standardized design, there is full interchangeability of parts allowing retrofit upgrades as needed.



Microflo' Dust Bags

For all Homecare models there are specific twin-layer dust bags that enhance the performance and simplify emptying:-

1 Microflo' NVM-1C/2 10 per pack (604100)

Twin-wall 2-stage and suitable for Henry, Henry 'Xtra, Henry Turbo and James

2 Microflo' NVM-1C/3 5 per pack (604005)

These high efficiency 3-stage dust bags have been especially developed for the British Allergy Foundation approved Henry Micro machine

3 Microflo' NVM-2B/2 10 per pack (604102)

These larger twin-wall 2-stage dust bags are suitable for both Charles and George when used in the Dry Mode - Not for Wet Use.

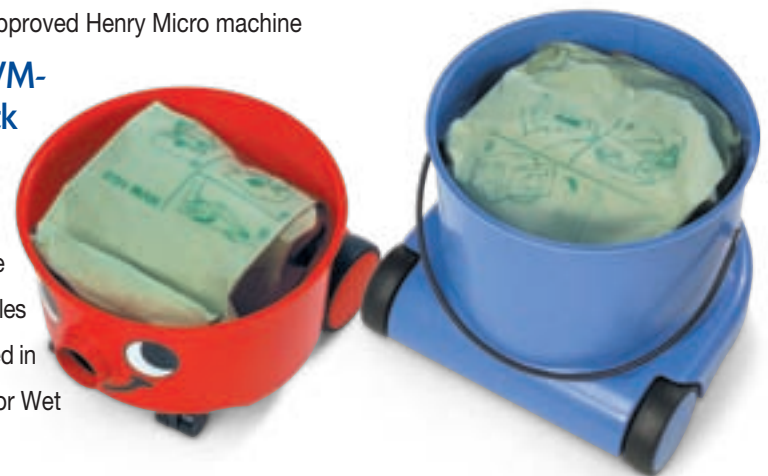

Interchangeable filters

For Homecare models there are optional filters to achieve a range of filtration requirements.

4 Microfresh Odour Control Filter (604170)

The 3-layer Microfresh filter system enhances filtration standards to 98% at 0.5 micron but equally important, it embodies a giant activated charcoal filter membrane sandwiched between twin Tritex filters, providing an effective odour control system... standard in the Henry 'Xtra and Turbo specifications but can be retro fitted to all Henry and James models.

5 Microtex Filter (604311)

This multilayer high efficiency filter has been developed for the Henry Micro machine and when used in conjunction with the 3-layer Microflo' dust bags (604005) will upgrade the machine to the full British Allergy Foundation approval standard (Dry Use Only).





6

With each Homecare model we have provided a comprehensive accessory kit to compliment the machines function and performance. To allow machine kits to be changed or upgraded there are a number of optional extras that may be selected.

6 Airo Brush Red (601226), Black (601227)

The Airo Brush is an exceptional floor nozzle developed to provide quick and efficient carpet care. This is especially effective for the removal of threads, dog and cat hairs... grooms the whole carpet and will allow power brush results where uprights can rarely go. A truly high performance Airo Power Brush, red for Henry Range, black for other models. (Standard on Henry 'Xtra)



6



6

7 Hard Floor Brush (601428)

A full 300mm twin brush floor nozzle with dual rubber wheels for quick, easy and efficient cleaning of all hard floor surfaces. Also provides excellent results on low profile fabric floor coverings. Suitable for all models.



7

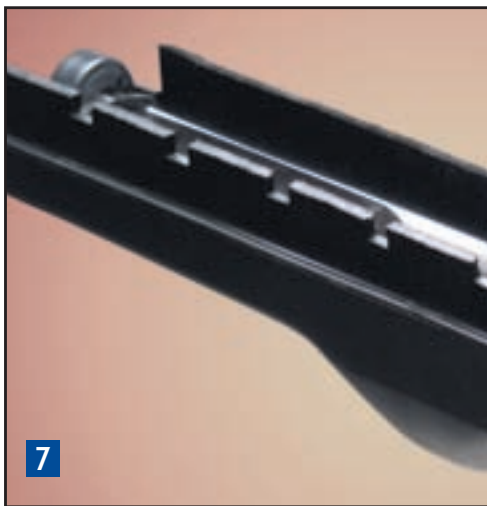

7

8 Microlight Tube Set (601026)

Many of our accessory kits include stainless steel tube sets, but for those wishing for something lighter we have a full tube set manufactured in aluminium, reducing the weight by 50%. (Standard on James and Charles)

8

9 Microlight Extension Tubes (601024)

If you find yourself cleaning at high levels regularly, then the Microlight extension tubes will prove to be of great benefit being 50% lighter than stainless steel. Each section is 422mm in length.

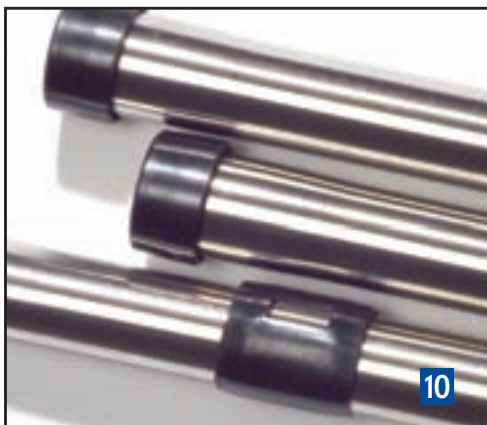

7

10 Stainless Steel Tube set (601023)

Long life stainless steel tube sets are in a class of their own but a little heavier than aluminium.

10

11 Stainless Steel Extension Tubes (601008)

Where longer reach is required additional 422mm extensions are available. (See also 9 Aluminium)



Homecare Accessory Kits 32mm

James Accessory Kit

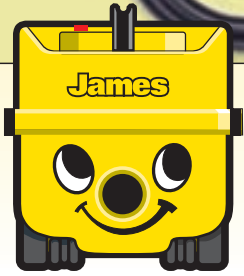

607089 Kit JV1 32mm Aluminium Combo Kit

- | | | | |
|------------|---|------------|--------------------------------|
| NVA-601010 | 1.9m Nuflex Bayonet Hose | NVA-601139 | 300mm Combination Floor Nozzle |
| NVA-601025 | Aluminium Tube Bend with Volume Control | NVA-601142 | 240mm Crevice Tool |
| NVA-601024 | Aluminium Extension Tube (2 off) | NVA-601344 | 60mm Multi Angle Brush |

Henry/Micro & Hetty Accessory Kit



607301 Kit A1 Full 32mm Stainless Steel Combo Kit

- | | | | |
|------------|---|------------|--|
| NVA-601101 | 2.4m Nuflex Threaded Hose | NVA-601142 | 240mm Crevice Tool |
| NVA-601027 | Stainless Steel Tube Bend with Volume Control | NVA-601144 | 65mm Soft Dusting Brush |
| NVA-601008 | Stainless Steel Extension Tube (2 off) | NVA-601145 | 150mm Upholstery Nozzle |
| NVA-601139 | 300mm Combination Floor Nozzle | NVA-601146 | 150mm Slide on Brush for Upholstery Nozzle |

Henry Xtra Accessory Kit



607170 Kit X1 Full 32mm Airo Brush Combo Kit

- | | | | |
|------------|---|------------|--|
| NVA-601101 | 2.4m Nuflex Threaded Hose | NVA-601141 | Double Taper Hose/Tool Adaptor |
| NVA-601027 | Stainless Steel Tube Bend with Volume Control | NVA-601142 | 240mm Crevice Tool |
| NVA-601008 | Stainless Steel Extension Tube (2 off) | NVA-601144 | 65mm Soft Dusting Brush |
| NVA-601139 | 300mm Combination Floor Nozzle | NVA-601145 | 150mm Upholstery Nozzle |
| NVA-601226 | 290mm Easy Ride Airo Brush (Red) | NVA-601146 | 150mm Slide on Brush for Upholstery Nozzle |

Henry Turbo Accessory Kit



607452 Kit T22 Henry Turbo Electric Kit

NVA-619061 2.0m Nuflex Turbo Electric Hose
 NVA-619080 300mm Turbo Electric Power Brush Nozzle, Red
 NVA-619015 300mm Combination Nozzle for Turbo Systems
 NVA-619007 Short Homecare Turbo Electric Aluminium Tube
 NVA-619120 Long Standard Turbo Electric Aluminium Tube

NVA-619031 Turbo Electric Hand Accessory Adaptor
 NVA-601142 240mm Crevice Tool
 NVA-601144 65mm Soft Dusting Brush
 NVA-601145 150mm Upholstery Nozzle
 NVA-601146 150mm Slide on Brush for Upholstery Nozzle

Charles Accessory Kit

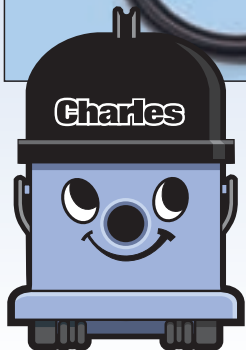

607221 Kit A21A Full 32mm Aluminium Wet and Dry Kit

NVA-601101 2.4m Nuflex Threaded Hose
 NVA-601025 Aluminium Tube Bend with Volume Control
 NVA-601024 Aluminium Extention Tube (2 off)
 NVA-601139 300mm Combination Floor Nozzle
 NVA-601328 300mm Wet Pick Up Nozzle

NVA-601141 Double Taper Hose/Tool Adaptor
 NVA-601142 240mm Crevice Tool
 NVA-601144 65mm Soft Dusting Brush
 NVA-601145 150mm Upholstery Nozzle
 NVA-601146 150mm Slide on Brush for Upholstery Nozzle

George Accessory Kit

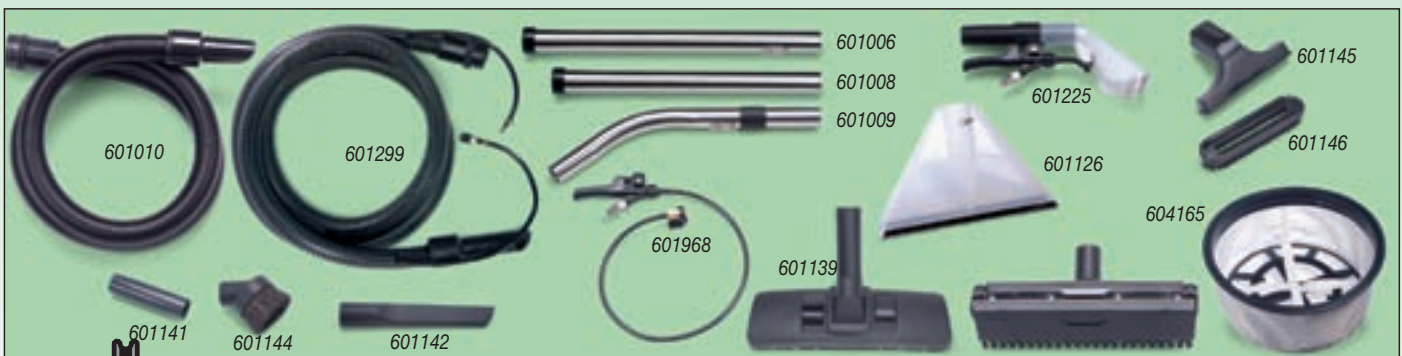

607326 Kit A26A Full 32mm Stainless Steel Spray Extraction Kit

NVA-601010 1.9m Nuflex Bayonet Hose
 NVA-601299 3.0m Cleantec Extraction Hose
 NVA-601009 Stainless Steel Extraction Trigger Bend Tube
 NVA-601006 Stainless Steel Lower Nozzle Extraction Tube
 NVA-601008 Stainless Steel Extention Tube
 NVA-601139 300mm Combination Floor Nozzle
 NVA-601126 275mm Fishtail Extraction Nozzle
 NVA-601827 300mm Dual Scrub/Wet Pick UP Nozzle

NVA-601225 100mm Upholstery Extraction Nozzle
 NVA-601968 Cleantec Trigger Valve and Spray Tube
 NVA-601144 65mm Soft Dusting Brush
 NVA-601142 240mm Crevice Tool
 NVA-601141 Double Taper Hose/Tool Adaptor
 NVA-604165 Tritex Filter for 12"/305mm dia Machines
 NVA-601145 150mm Wide Upholstery Nozzle
 NVA-601146 150mm Wide Slide on Brush for Upholstery Nozzle

Numatic United Kingdom

Numatic International Limited,
Chard, Somerset, TA20 2GB,
UNITED KINGDOM
Telephone: 01460 68480
Fax: 01460 68560
Sales- Tel: 01460 68600
Fax: 01460 68458
www.numatic.co.uk

Numatic France

Numatic International S.A.
13/17 rue du Valengelier,
EAE la Tuilerie,
77501 Chelles Cedex,
FRANCE
Tel: 01 64 72 61 61
Fax: 01 64 72 61 62
www.numatic.fr

Numatic Germany

Numatic International GmbH
Fränkische Straße 15-19,
30455 Hannover
DEUTSCHLAND
Tel: 05 11 98 42 16 0
Fax: 05 11 98 42 16 20
www.numatic.de

Numatic Netherlands

BeNeLux Distribution

Numatic International BV
Postbus 101
2400 AC Alphen aan den Rijn
NEDERLAND
Tel: 0172 467 999
Fax: 0172 467 970
www.numatic.nl

Numatic South Africa

Numatic International (Pty.) Ltd.
Tillbury Business Park,
16th Road, Randjes Park,
Midrand,
SOUTH AFRICA
P.O. Box 3867,
Midrand 1685
Tel: 011 314 1875
Fax: 011 314 1816
www.numatic.co.za

