

Wand-/Deckenverdampfer

Unit coolers



2



GÜNTNER *incline design*
3°



GHN.2

50 Hz

R404A, R507, R134a, R22, ...

- Verbesserter Tauwasserrücklauf und verbesserte Luftführung durch Güntner Incline Design
- Gute Zugänglichkeit: aufklappbare Seitenverkleidung + optional schwenkbare Ventilatoren
- Hohe Wurfweiten durch optionale Güntner Streamer
- Kondenswasserfreie Wannenkonstruktion
- 2 Ventilatorausführungen
- Improved condensation water drain and routing of air flow with Güntner Incline Design
- Good accessibility: hinged side covering + optional: swiveling fans
- Improved air throw with optional Güntner Streamer
- Condensation-water-free drip tray
- 2 types of fans available



schwenkbare Seitenverkleidung

hinged side covering

Anwendungsvorteile für Betreiber

Application benefits for operators

GÜNTNER *incline design*



Güntner Incline Design

- Bessere Luftführung
- Besserer Tauwasserrücklauf

Kondenswasser-freie Wannenkonstruktion

Die thermisch entkoppelte Tropfwanne reduziert Kondenswasserbildung an der Außenseite.



Zeitsparende Reinigung

Hygienevorschriften verlangen eine gründliche Reinigung des gesamten Verdampfers. Durch schwenkbare Ventilatoren (optional) können – mit einfachen Handgriffen – Öffnungen zum Reinigen des Wärmeaustauscherblockes und Innenraums geschaffen werden.

Abtauklappe

- Sichere und vollständige Abtaugung
- Die Abtauwärme bleibt im inneren des Gehäuses

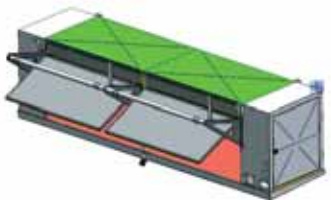

Güntner Incline Design

- Better routing of air flow
- Improved condensation water drain

Condensation-water-free drip tray construction

The drip tray prevents formation of condensation water at the outside due to its thermal properties.

Timesaving cleaning

Hygiene regulations require thorough cleaning of the entire evaporator coil. The swiveling fans (optional) make it possible to create without much ado openings for the cleaning of the heat exchanger coil and of the unit's interior.

Defrost flap

- Safe and complete defrosting
- The defrosting heat remains in the evaporator casing

Nomenklatur / Nomenclature

Wand-/Deckenverdampfer Unit coolers	GHN	
Ventilator Fan	071	Ø 710 mm
Generation Generation	.2	
Blockgröße Coil size	F /	
Anzahl der Ventilatoren Number of fans	2	
Lamellenteilung Fin spacing	7	
Luftabtaugung oder keine Abtaugung Air defrost or non defrost		- A
Abtaugung auf Wunsch elektrisch Electric defrost on request		- E
Heißgasabtaugung auf Wunsch Hot gas defrost on request		- H
Ventilatoren normale Ausführung fans standard design		- N
Ventilatoren verstärkte Ausführung fans reinforced design		- H
Spannung / Phase / Frequenz Voltage / Phase / Frequency	400 V 3~ 50 Hz Δ	D W S
	230 V 1~ 50 Hz	
	400 V 3~ 50 Hz Y	

Anwendungsvorteile für Anlagenbauer und Planer

Application benefits for contractors and planners



Montage / Service / Messung **Aufklappen - Loslegen**

Die Anschlüsse sind einfach durch die aufklappbaren Seitenwände erreichbar. Noch leichter zu öffnen mit den Schnappverschlüssen für die Baugrößen 071 und 080.

Kostenreduzierung bei der **Installation**

Werkseitig vormontierte Baugruppen (optional) reduzieren die Kosten bei der Installation.

- Expansionsventil werkseitig eingebaut
- Verrohrung der Heißgasabtauung zwischen Tropfwanne und Block
- Montage Rückschlagventil Heißgasabtauung

Sie müssen vor Ort nur noch den Verdampfer positionieren, an die Elektroversorgung anklemmen und das Rohrsystem anschließen.

Ventilator

- Bewährte Qualitätsventilatoren
- Hohe Wurfweiten durch optionale Güntner-Streamer
- Hohe Luftmenge
- Guter Wirkungsgrad
- 2 Ventilatorausführungen
 - normal
 - verstärkt

... keep(s) your quality

- Zuverlässiger Betrieb durch ausgereiftes und bewährtes Produkt
- Ansprechendes Design
- Kein Kondensatauswurf durch optimierte Luftgeschwindigkeiten in der Grundversion
- Optional verstärkte Ventilatoren für erhöhte Luftumwälzung
- Realisierung von kundenspezifischen Lösungen außerhalb des Standards möglich

Assembly/Maintenance/Gauging **Open and get started**

The connections are easily accessible through the hinged side coverings. Even easier to open with the snaplocks which are available for sizes 071 and 080.

Reduced installation costs

Components pre-assembled ex works (optional) of certain components reduce installation costs.

- Expansion valve installed ex works
- Pipe installation for hot gas defrosting between drip tray and coil
- Fitting of return valve for hot gas defrosting

All that remains to be done on site is to position the evaporator and connect it to the power supply and the pipe system.

Fan

- Reliable high-quality fans
- Extended air throw due to optional Güntner Streamer
- Large air quantity
- High efficiency
- 2 types of fans available
 - standard
 - reinforced

... keep(s) your quality

- Reliable operation of a tried and tested unit
- Pleasing design
- No spouting of condensation water due to optimised air velocities in the basic version
- Optional: more powerful fans for increased air circulation
- It is possible to realise customised solutions beyond the standard

GHN.2 - 1 Ventilator - 1 Fan

Typ Type	Nennleistung Nominal capacity R404A		Fläche Surface	Luftvolumenstrom Air volume flow	Wurfweite ohne Streamer Air throw without Streamer	Wurfweite mit Streamer Air throw with Streamer	Schalldruck Sound pressure	Anschlüsse Connections				El. Abtauheizung El. defrost			Anschlusschema Connection diagram	aufgenommene elektrische Leistung power consumption P _{el} total	Anschlussklemmen optionale Ventilatorverkabelung connection terminals optional fan wiring
	SC2 DT1 = 8 K t _b = - 8 °C	SC3 DT1 = 7 K t _b = - 25 °C						Ein Inlet	Aus Outlet	Heißgas Block ein Hot gas coil inlet	Heißgas Wanne ein / aus Hot gas tray inlet / outlet	Block Coil	Tropfwanne Drip tray	Gesamt Total			
040.2D/14-ANW50	5,2	4,1	32,7	3060	11	24	52	16*	22,0	15	15	1620	700	2,32	1 × A	0,22	1 × E
040.2F/14-ANW50	6,6	5,3	49,0	2810	10	23	52	16*	22,0	15	15	2700	1000	3,70	1 × B	0,22	1 × E
045.2D/14-ANW50	8,5	6,6	51,3	5110	15	33	56	16*	22,0	15	15	2580	1200	3,78	1 × B	0,50	1 × E
045.2E/14-ANW50	9,8	8,0	64,2	4860	14	32	56	16*	28,0	15	15	3440	1200	4,64	1 × B	0,51	1 × E
050.2D/14-ANS50	11,1	8,7	67,3	6650	19	38	56	16*	28,0	15	15	3000	1300	4,30	1 × B	0,52	1 × I
050.2E/14-ANS50	12,9	10,2	84,1	6470	19	36	56	16*	28,0	15	15	3750	1300	5,05	1 × B	0,53	1 × I
050.2F/14-ANS50	14,5	11,7	100,9	6300	18	34	56	22*	35,0	15	15	4500	1950	6,45	1 × B	0,54	1 × I
071.2D/14-AND50	19,6	15,8	117,6	11760	32	57	55	22*	42,0	15	15	6250	2700	8,95	1 × C	0,80	1 × G
071.2E/14-AND50	22,6	18,0	147,0	11230	32	56	55	22*	42,0	15	15	7500	2700	10,20	1 × C	0,81	1 × G
071.2F/14-AND50	24,7	19,3	176,4	10790	31	54	55	22*	42,0	22	22	8750	2700	11,45	1 × C	0,82	1 × G
080.2D/14-AND50	30,3	24,0	184,5	17970	39	68	63	22*	42,0	22	22	9000	3450	12,45	1 × C	1,35	1 × G
080.2E/14-AND50	35,2	28,1	230,7	17280	38	66	63	28*	54,0	22	22	12000	3450	15,45	2 × C	1,36	1 × G
080.2F/14-AND50	38,9	31,4	276,8	16720	37	64	63	28*	64,0	22	22	13500	3450	16,95	2 × C	1,36	1 × G
040.2F/17-ANW50	5,6	4,5	28,8	3100	12	24	52	16*	22,0	15	15	2700	1000	3,70	1 × B	0,22	1 × E
040.2H/17-ANW50	6,6	5,4	38,4	2930	11	23	52	16*	28,0	15	15	3240	1000	4,24	1 × B	0,22	1 × E
045.2E/17-ANW50	7,9	6,2	37,7	5320	15	36	56	16*	22,0	15	15	3440	1200	4,64	1 × B	0,49	1 × E
045.2F/17-ANW50	9,2	7,3	45,3	5190	14	35	56	16*	28,0	15	15	4300	1800	6,10	1 × B	0,50	1 × E
045.2H/17-ANW50	10,9	8,8	60,4	4840	14	33	56	16*	35,0	15	15	6020	1800	7,82	1 × B	0,51	1 × E
050.2F/17-ANS50	12,0	9,6	59,4	6700	20	38	56	16*	35,0	15	15	4500	1950	6,45	1 × B	0,51	1 × I
050.2H/17-ANS50	14,3	11,5	79,1	6420	19	36	56	22*	35,0	15	15	6750	1950	8,70	1 × B	0,53	1 × I
071.2E/17-AND50	18,4	14,7	86,5	12200	32	58	55	22*	42,0	15	15	7500	2700	10,20	1 × C	0,78	1 × G
071.2F/17-AND50	21,0	16,7	103,8	11890	32	57	55	22*	42,0	22	22	8750	2700	11,45	1 × C	0,80	1 × G
071.2H/17-AND50	25,0	20,1	138,4	11190	32	54	55	22*	42,0	22	22	11250	2700	13,95	1 × C	0,81	1 × G
080.2E/17-AND50	28,2	22,4	135,7	18520	40	69	63	22*	42,0	22	22	12000	3450	15,45	2 × C	1,33	1 × G
080.2F/17-AND50	32,1	25,0	162,8	18170	39	68	63	22*	42,0	22	22	13500	3450	16,95	2 × C	1,34	1 × G
080.2H/17-AND50	38,4	30,3	217,1	17210	38	66	63	28*	54,0	22	22	18000	3450	21,45	2 × C	1,36	1 × G
040.2F/110-ANW50	4,6	3,6	20,8	3210	13	25	52	16*	22,0	15	15	2700	1000	3,70	1 × B	0,21	1 × E
040.2H/110-ANW50	5,7	4,6	27,7	3060	12	24	52	16*	22,0	15	15	3240	1000	4,24	1 × B	0,22	1 × E
045.2E/110-ANW50	6,5	5,1	27,2	5530	15	37	56	16*	22,0	15	15	3440	1200	4,64	1 × B	0,48	1 × E
045.2F/110-ANW50	7,7	6,1	32,6	5400	15	36	56	16*	28,0	15	15	4300	1800	6,10	1 × B	0,49	1 × E
045.2H/110-ANW50	9,3	7,3	43,5	5070	14	34	56	16*	28,0	15	15	6020	1800	7,82	1 × B	0,50	1 × E
050.2H/110-ANS50	12,3	9,9	57,0	6620	20	39	56	22*	35,0	15	15	6750	1950	8,70	1 × B	0,52	1 × I
071.2E/110-AND50	14,9	12,0	62,3	12550	33	59	55	22*	42,0	15	15	7500	2700	10,20	1 × C	0,77	1 × G
071.2F/110-AND50	17,5	14,0	74,8	12330	33	58	55	22*	42,0	22	22	8750	2700	11,45	1 × C	0,78	1 × G
071.2H/110-AND50	21,4	16,7	99,7	11720	32	56	55	22*	42,0	22	22	11250	2700	13,95	1 × C	0,80	1 × G
080.2F/110-AND50	26,8	21,2	117,3	18660	40	70	63	22*	42,0	22	22	13500	3450	16,95	2 × C	1,33	1 × G
080.2H/110-AND50	33,4	26,6	156,4	17970	39	68	63	28*	54,0	22	22	18000	3450	21,45	2 × C	1,35	1 × G
040.2F/112-ANW50	4,2	3,3	17,6	3300	14	24	52	16*	22,0	15	15	2700	1000	3,70	1 × B	0,21	1 × E
040.2H/112-ANW50	5,3	4,2	23,5	3140	13	24	52	16*	22,0	15	15	3240	1000	4,24	1 × B	0,21	1 × E
045.2E/112-ANW50	5,9	4,7	23,1	5650	16	37	56	16*	22,0	15	15	3440	1200	4,64	1 × B	0,48	1 × E
045.2F/112-ANW50	6,9	5,4	27,7	5550	15	37	56	16*	22,0	15	15	4300	1800	6,10	1 × B	0,48	1 × E
045.2H/112-ANW50	8,6	6,8	37,0	5260	15	35	56	16*	28,0	15	15	6020	1800	7,82	1 × B	0,49	1 × E
050.2H/112-ANS50	11,3	9,1	48,4	6750	20	40	56	22*	35,0	15	15	6750	1950	8,70	1 × B	0,51	1 × I
071.2E/112-AND50	13,4	10,8	52,9	12770	33	60	55	22*	42,0	15	15	7500	2700	10,20	1 × C	0,76	1 × G
071.2F/112-AND50	15,9	12,8	63,5	12600	33	59	55	22*	42,0	22	22	8750	2700	11,45	1 × C	0,77	1 × G
071.2H/112-AND50	19,8	15,6	84,7	12070	32	57	55	22*	42,0	22	22	11250	2700	13,95	1 × C	0,79	1 × G
080.2F/112-AND50	24,3	19,4	99,6	19000	40	70	63	22*	42,0	22	22	13500	3450	16,95	2 × C	1,32	1 × G
080.2H/112-AND50	30,7	24,6	132,9	18310	40	68	63	28*	54,0	22	22	18000	3450	21,45	2 × C	1,33	1 × G

* Mehrfacheinspritzung
* Multiple injection 

Gewicht und Maße

Weights and Measures

GHN.2 - 1 Ventilator - 1 Fan												
Typ Type	Rohrvolumen Tube volume	Nettogewicht Net weight	Abmessungen Dimensions									Ablauf G-Gewinde flach- dichtend Drain G-thread flat sealing DIN-ISO 228-1
			L	B	H	E	F	C	M	S	A	
	l	kg	mm	mm	mm	mm	mm	mm	mm	mm	mm	K
040.2D/14-ANW50	6,0	42	1090	540	545	680	425	210	866	575	400	G1¼"
040.2F/14-ANW50	9,0	57	1090	815	555	680	700	210	866	850	400	G1¼"
045.2D/14-ANW50	8,9	55	1360	665	645	890	545	240	960	695	500	G1¼"
045.2E/14-ANW50	11,1	67	1360	665	645	890	545	240	960	695	500	G1¼"
050.2D/14-ANS50	11,5	73	1470	645	745	1000	545	240	1060	695	550	G1¼"
050.2E/14-ANS50	14,3	82	1470	645	745	1000	545	240	1060	695	550	G1¼"
050.2F/14-ANS50	17,2	96	1470	825	755	1000	700	240	1060	850	550	G1¼"
071.2D/14-AND50	19,1	192	2100	900	950	1360	715	380	1217	875	700	G2"
071.2E/14-AND50	23,9	208	2100	900	950	1360	715	380	1217	875	700	G2"
071.2F/14-AND50	28,7	236	2100	1050	960	1360	865	380	1217	1025	700	G2"
080.2D/14-AND50	29,4	254	2340	910	1250	1600	715	380	1517	875	700	G2"
080.2E/14-AND50	36,8	278	2340	910	1250	1600	715	380	1517	875	700	G2"
080.2F/14-AND50	44,1	345	2340	1060	1260	1600	865	380	1517	1025	700	G2"
040.2F/17-ANW50	9,0	52	1090	815	555	680	700	210	866	850	400	G1¼"
040.2H/17-ANW50	12,0	57	1090	815	555	680	700	210	866	850	400	G1¼"
045.2E/17-ANW50	11,1	60	1360	625	645	890	545	240	960	695	500	G1¼"
045.2F/17-ANW50	13,4	70	1360	815	655	890	700	240	960	850	500	G1¼"
045.2H/17-ANW50	17,8	78	1360	815	655	890	700	240	960	850	500	G1¼"
050.2F/17-ANS50	17,2	81	1470	825	755	1000	700	240	1060	850	550	G1¼"
050.2H/17-ANS50	22,9	96	1470	825	755	1000	700	240	1060	850	550	G1¼"
071.2E/17-AND50	23,9	177	2100	900	950	1360	715	380	1217	875	700	G2"
071.2F/17-AND50	28,7	220	2100	1050	960	1360	865	380	1217	1025	700	G2"
071.2H/17-AND50	38,2	235	2100	1050	960	1360	865	380	1217	1025	700	G2"
080.2E/17-AND50	36,8	255	2340	910	1250	1600	715	380	1517	875	700	G2"
080.2F/17-AND50	44,1	291	2340	1060	1260	1600	865	380	1517	1025	700	G2"
080.2H/17-AND50	58,8	320	2340	1060	1260	1600	865	380	1517	1025	700	G2"
040.2F/110-ANW50	9,0	50	1090	815	555	680	700	210	866	850	400	G1¼"
040.2H/110-ANW50	11,7	57	1090	815	555	680	700	210	866	850	400	G1¼"
045.2E/110-ANW50	11,1	58	1360	665	645	890	545	240	960	695	500	G1¼"
045.2F/110-ANW50	13,4	67	1360	815	655	890	700	240	960	850	500	G1¼"
045.2H/110-ANW50	17,8	77	1360	815	655	890	700	240	960	850	500	G1¼"
050.2H/110-ANS50	22,9	96	1470	825	755	1000	700	240	1060	850	550	G1¼"
071.2E/110-AND50	23,9	188	2100	900	950	1360	715	380	1217	875	700	G2"
071.2F/110-AND50	28,7	212	2100	1050	960	1360	865	380	1217	1025	700	G2"
071.2H/110-AND50	38,2	235	2100	1050	960	1360	865	380	1217	1025	700	G2"
080.2F/110-AND50	44,1	280	2340	1060	1260	1600	865	380	1517	1025	700	G2"
080.2H/110-AND50	58,8	320	2340	1060	1260	1600	865	380	1517	1025	700	G2"
040.2F/112-ANW50	9,0	49	1090	815	555	680	700	210	866	850	400	G1¼"
040.2H/112-ANW50	11,7	55	1090	815	555	680	700	210	866	850	400	G1¼"
045.2E/112-ANW50	11,1	56	1360	665	645	890	545	240	960	695	500	G1¼"
045.2F/112-ANW50	13,4	65	1360	815	655	890	700	240	960	850	500	G1¼"
045.2H/112-ANW50	17,8	75	1360	815	655	890	700	240	960	850	500	G1¼"
050.2H/112-ANS50	22,9	92	1470	825	755	1000	700	240	1060	850	550	G1¼"
071.2E/112-AND50	23,9	183	2100	900	950	1360	715	380	1217	875	700	G2"
071.2F/112-AND50	28,7	209	2100	1050	960	1360	865	380	1217	1025	700	G2"
071.2H/112-AND50	38,2	231	2100	1050	960	1360	865	380	1217	1025	700	G2"
080.2F/112-AND50	44,1	275	2340	1060	1260	1600	865	380	1517	1025	700	G2"
080.2H/112-AND50	58,8	314	2340	1060	1260	1600	865	380	1517	1025	700	G2"

Wandkonsolen für Typen 040.2, 045.2, 050.2
wall brackets for types

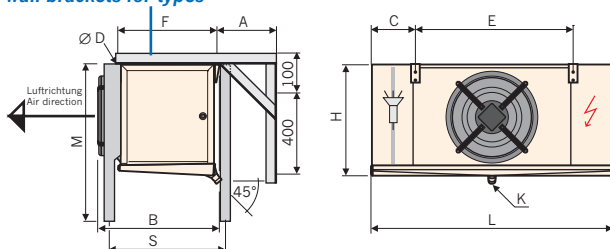

Deckenaufhänger
ceiling hangers

Baugröße / Size
040 - 050 071 - 080

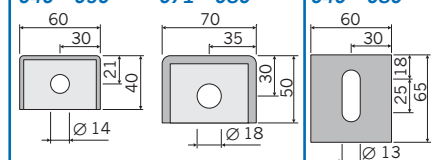

Fußplatte
base plate

040 - 080

GHN.2 - 2 Ventilatoren - 2 Fans

Typ Type	Nennleistung Nominal capacity R404A		Fläche Surface	Luftvolumenstrom Air volume flow	Wurfweite ohne Streamer Air throw without Streamer	Wurfweite mit Streamer Air throw with Streamer	Schalldruck Sound pressure	Anschlüsse Connections				El. Abtauheizung El. defrost			Anschlussschema Connection diagram	aufgenommene elektrische Leistung power consumption P _{el} total	Anschlussklemmen optionale Ventilatorverkabelung connection terminals optional fan wiring
	SC2 DT1 = 8 K t _b = - 8 °C	SC3 DT1 = 7 K t _b = - 25 °C						Kältemittel Refrigerant		400 V							
	kW	kW	m ²	m ³ /h	m	m	dB(A)/3m	Ein Inlet	Aus Outlet	Heißgas Block ein Hot gas coil inlet	Heißgas Wanne ein / aus Hot gas tray inlet / outlet	Block Coil	Tropfwanne Drip tray	Gesamt Total	W	W	W
040.2D/24-ANW50	10,5	8,3	65,4	6120	12	27	55	16*	28,0	15	15	3750	1200	4,95	1 × A	0,43	1 × E
040.2F/24-ANW50	13,2	10,4	98,0	5620	11	26	55	16*	28,0	15	15	6250	1700	7,95	1 × B	0,44	1 × E
045.2D/24-ANW50	17,0	13,3	102,6	10220	17	36	59	16*	35,0	15	15	4500	2300	6,80	1 × B	0,99	1 × E
045.2E/24-ANW50	19,7	15,9	128,3	9720	16	35	59	22*	42,0	15	15	6000	2300	8,30	1 × B	1,01	1 × E
050.2D/24-ANS50	21,9	16,9	134,5	13300	21	41	59	22*	35,0	22	22	7000	2400	9,40	1 × B	1,03	1 × I
050.2E/24-ANS50	25,5	20,4	168,2	12940	21	39	59	22*	42,0	22	22	8750	2400	11,15	1 × B	1,05	1 × I
050.2F/24-ANS50	29,0	23,5	201,8	12600	20	37	59	28*	54,0	22	22	10500	3600	14,10	1 × B	1,07	1 × I
071.2D/24-AND50	39,3	31,6	235,3	23520	35	64	57	28*	64,0	22	22	12500	4500	17,00	2 × C	1,59	2 × G
071.2E/24-AND50	44,7	34,7	294,1	22460	35	63	57	28*	54,0	22	22	15000	4500	19,50	2 × C	1,61	2 × G
071.2F/24-AND50	50,1	40,8	352,9	21580	34	61	57	35*	76,1	22	22	17500	4500	22,00	2 × C	1,64	2 × G
080.2D/24-AND50	60,6	48,2	369,0	35940	43	75	66	28*	64,0	22	22	18000	6000	24,00	2 × C	2,69	2 × G
080.2E/24-AND50	70,4	56,4	461,3	34560	42	73	66	35*	76,1	22	22	24000	6000	30,00	3 × C	2,71	2 × G
080.2F/24-AND50	78,0	62,9	553,6	33440	41	71	66	42*	76,1	28	28	27000	6000	33,00	3 × C	2,72	2 × G
040.2F/27-ANW50	11,3	9,0	57,7	6200	13	27	55	16*	28,0	15	15	6250	1700	7,95	1 × B	0,43	1 × E
040.2H/27-ANW50	13,1	10,2	76,9	5860	12	26	55	16*	28,0	15	15	7500	1700	9,20	1 × B	0,43	1 × E
045.2E/27-ANW50	15,9	12,4	75,5	10640	17	39	59	16*	35,0	15	15	6000	2300	8,30	1 × B	0,98	1 × E
045.2F/27-ANW50	18,4	14,8	90,6	10380	16	38	59	22*	42,0	22	22	7500	3450	10,95	1 × B	0,99	1 × E
045.2H/27-ANW50	21,3	16,5	120,8	9680	16	36	59	22*	42,0	22	22	10500	3450	13,95	1 × B	1,01	1 × E
050.2F/27-ANS50	23,4	18,6	118,7	13400	22	41	59	22*	42,0	22	22	10500	3600	14,10	1 × B	1,01	1 × I
050.2H/27-ANS50	28,7	23,1	158,3	12840	21	39	59	28*	54,0	22	22	15750	3600	19,35	2 × B	1,05	1 × I
071.2E/27-AND50	36,6	28,9	173,0	24400	35	65	57	28*	54,0	22	22	15000	4500	19,50	2 × C	1,56	2 × G
071.2F/27-AND50	42,1	33,4	207,6	23780	35	64	57	28*	64,0	22	22	17500	4500	22,00	2 × C	1,59	2 × G
071.2H/27-AND50	50,0	40,2	276,8	22380	35	61	57	28*	64,0	22	22	22500	4500	27,00	2 × C	1,61	2 × G
080.2E/27-AND50	55,8	43,3	271,3	37040	44	76	66	28*	64,0	22	22	24000	6000	30,00	3 × C	2,66	2 × G
080.2F/27-AND50	64,4	50,2	325,6	36340	43	75	66	28*	64,0	28	28	27000	6000	33,00	3 × C	2,68	2 × G
080.2H/27-AND50	76,4	60,9	434,2	34420	42	73	66	35*	76,1	28	28	36000	6000	42,00	4 × C	2,71	2 × G
040.2F/210-ANW50	9,4	7,5	41,6	6420	14	28	55	16*	28,0	15	15	6250	1700	7,95	1 × B	0,42	1 × E
040.2H/210-ANW50	11,5	9,0	55,4	6120	13	27	55	16*	28,0	15	15	7500	1700	9,20	1 × B	0,43	1 × E
045.2E/210-ANW50	13,1	10,4	54,4	11060	17	40	59	16*	35,0	15	15	6000	2300	8,30	1 × B	0,96	1 × E
045.2F/210-ANW50	15,1	11,8	65,3	10800	17	39	59	16*	35,0	22	22	7500	3450	10,95	1 × B	0,98	1 × E
045.2H/210-ANW50	18,6	14,6	87,0	10140	16	37	59	22*	42,0	22	22	10500	3450	13,95	1 × B	0,99	1 × E
050.2H/210-ANS50	24,6	19,9	114,1	13240	22	42	59	28*	54,0	22	22	15750	3600	19,35	2 × B	1,03	1 × I
071.2E/210-AND50	29,9	23,9	124,7	25100	36	66	57	28*	54,0	22	22	15000	4500	19,50	2 × C	1,54	2 × G
071.2F/210-AND50	35,1	28,1	149,6	24660	36	65	57	28*	64,0	22	22	17500	4500	22,00	2 × C	1,56	2 × G
071.2H/210-AND50	42,8	33,7	199,5	23440	35	63	57	28*	64,0	22	22	22500	4500	27,00	2 × C	1,59	2 × G
080.2F/210-AND50	53,7	42,5	234,7	37320	44	77	66	28*	64,0	28	28	27000	6000	33,00	3 × C	2,66	2 × G
080.2H/210-AND50	66,8	53,3	312,9	35940	43	75	66	35*	76,1	28	28	36000	6000	42,00	4 × C	2,69	2 × G
040.2F/212-ANW50	8,6	6,9	35,3	6600	15	27	55	16*	28,0	15	15	6250	1700	7,95	1 × B	0,41	1 × E
040.2H/212-ANW50	10,6	8,4	47,1	6280	14	27	55	16*	28,0	15	15	7500	1700	9,20	1 × B	0,42	1 × E
045.2E/212-ANW50	11,8	9,4	46,2	11300	18	40	59	16*	35,0	15	15	6000	2300	8,30	1 × B	0,95	1 × E
045.2F/212-ANW50	13,8	10,8	55,4	11100	17	40	59	16*	35,0	22	22	7500	3450	10,95	1 × B	0,96	1 × E
045.2H/212-ANW50	17,3	13,7	73,9	10520	17	38	59	22*	42,0	22	22	10500	3450	13,95	1 × B	0,98	1 × E
050.2H/212-ANS50	22,6	18,3	96,9	13500	22	43	59	28*	54,0	22	22	15750	3600	19,35	2 × B	1,01	1 × I
071.2E/212-AND50	26,9	21,6	105,9	25540	36	67	57	28*	54,0	22	22	15000	4500	19,50	2 × C	1,52	2 × G
071.2F/212-AND50	31,8	25,6	127,0	25200	36	66	57	28*	64,0	22	22	17500	4500	22,00	2 × C	1,54	2 × G
071.2H/212-AND50	39,7	31,4	169,4	24140	35	64	57	28*	64,0	22	22	22500	4500	27,00	2 × C	1,58	2 × G
080.2F/212-AND50	48,7	38,8	199,3	38000	44	77	66	28*	64,0	28	28	27000	6000	33,00	3 × C	2,64	2 × G
080.2H/212-AND50	61,5	49,3	265,7	36620	44	75	66	35*	76,1	28	28	36000	6000	42,00	4 × C	2,66	2 × G

* Mehrfacheinspritzung 
* Multiple injection

GHN.2 - 2 Ventilatoren - 2 Fans												
Typ Type	Rohrvolumen Tube volume	Nettogewicht Net weight	Abmessungen Dimensions									Ablauf G-Gewinde flach- dichtend Drain G-thread flat sealing DIN-ISO 228-1
			L	B	H	E	F	C	M	S	A	
	l	kg	mm	mm	mm	mm	mm	mm	mm	mm	mm	K
040.2D/24-ANW50	10,6	75	1770	540	545	1360	425	210	866	575	400	G1¼"
040.2F/24-ANW50	15,9	101	1770	815	555	1360	700	210	866	850	400	G1¼"
045.2D/24-ANW50	16,2	97	2250	665	645	1780	545	240	960	695	500	G1¼"
045.2E/24-ANW50	20,2	121	2250	665	645	1780	545	240	960	695	500	G1¼"
050.2D/24-ANS50	21,0	131	2470	645	745	2000	545	240	1060	695	550	G1¼"
050.2E/24-ANS50	24,7	150	2470	645	745	2000	545	240	1060	695	550	G1¼"
050.2F/24-ANS50	31,4	184	2470	825	755	2000	700	240	1060	850	550	G1¼"
071.2D/24-AND50	35,7	313	3460	900	950	2720	715	380	1217	875	700	G2"
071.2E/24-AND50	44,7	342	3460	900	950	2720	715	380	1217	875	700	G2"
071.2F/24-AND50	53,6	392	3460	1050	960	2720	865	380	1217	1025	700	G2"
080.2D/24-AND50	55,5	424	3960	910	1250	3200	715	380	1517	875	700	G2"
080.2E/24-AND50	69,3	470	3950	910	1250	3200	715	380	1517	875	700	G2"
080.2F/24-AND50	83,2	580	3950	1060	1260	3200	865	380	1517	1025	700	G2"
040.2F/27-ANW50	15,9	92	1770	815	555	1360	700	210	866	850	400	G1¼"
040.2H/27-ANW50	21,2	100	1770	815	555	1360	700	210	866	850	400	G1¼"
045.2E/27-ANW50	20,2	108	2250	665	645	1780	545	240	960	695	500	G1¼"
045.2F/27-ANW50	24,3	125	2250	815	655	1780	700	240	960	850	500	G1¼"
045.2H/27-ANW50	32,3	138	2250	815	655	1780	700	240	960	850	500	G1¼"
050.2F/27-ANS50	29,9	154	2470	825	755	2000	700	240	1060	850	550	G1¼"
050.2H/27-ANS50	41,9	184	2470	825	755	2000	700	240	1060	850	550	G1¼"
071.2E/27-AND50	44,7	279	3460	900	950	2720	715	380	1217	875	700	G2"
071.2F/27-AND50	53,6	357	3460	1050	960	2720	865	380	1217	1025	700	G2"
071.2H/27-AND50	71,5	387	3460	1050	960	2720	865	380	1217	1025	700	G2"
080.2E/27-AND50	69,3	425	3950	910	1250	3200	715	380	1517	875	700	G2"
080.2F/27-AND50	83,2	483	3950	1060	1260	3200	865	380	1517	1025	700	G2"
080.2H/27-AND50	111,0	531	3950	1060	1260	3200	865	380	1517	1025	700	G2"
040.2F/210-ANW50	15,9	88	1770	815	555	1360	700	210	866	850	400	G1¼"
040.2H/210-ANW50	21,2	100	1770	815	555	1360	700	210	866	850	400	G1¼"
045.2E/210-ANW50	20,2	103	2250	665	645	1780	545	240	960	695	500	G1¼"
045.2F/210-ANW50	24,3	117	2250	815	655	1780	700	240	960	850	500	G1¼"
045.2H/210-ANW50	32,3	138	2250	815	655	1780	700	240	960	850	500	G1¼"
050.2H/210-ANS50	41,9	185	2470	825	755	2000	700	240	1060	850	550	G1¼"
071.2E/210-AND50	44,7	302	3460	900	950	2720	715	380	1217	875	700	G2"
071.2F/210-AND50	53,6	341	3460	1050	960	2720	865	380	1217	1025	700	G2"
071.2H/210-AND50	71,5	386	3460	1050	960	2720	865	380	1217	1025	700	G2"
080.2F/210-AND50	83,2	461	3950	1060	1260	3200	865	380	1517	1025	700	G2"
080.2H/210-AND50	111,0	531	3950	1060	1260	3200	865	380	1517	1025	700	G2"
040.2F/212-ANW50	15,9	85	1770	815	555	1360	700	210	866	850	400	G1¼"
040.2H/212-ANW50	21,2	96	1770	815	555	1360	700	210	866	850	400	G1¼"
045.2E/212-ANW50	20,2	98	2250	665	645	1780	545	240	960	695	500	G1¼"
045.2F/212-ANW50	24,3	114	2250	815	655	1780	700	240	960	850	500	G1¼"
045.2H/212-ANW50	32,3	135	2250	815	655	1780	700	240	960	850	500	G1¼"
050.2H/212-ANS50	41,9	176	2470	825	755	2000	700	240	1060	850	550	G1¼"
071.2E/212-AND50	44,7	292	3460	900	950	2720	715	380	1217	875	700	G2"
071.2F/212-AND50	53,6	334	3460	1050	960	2720	865	380	1217	1025	700	G2"
071.2H/212-AND50	71,5	377	3460	1050	960	2720	865	380	1217	1025	700	G2"
080.2F/212-AND50	83,2	451	3950	1060	1260	3200	865	380	1517	1025	700	G2"
080.2H/212-AND50	111,0	518	3950	1060	1260	3200	865	380	1517	1025	700	G2"

Wandkonsolen für Typen 040.2, 045.2, 050.2
wall brackets for types

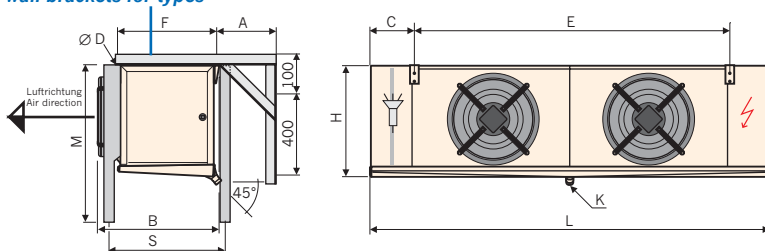

Deckenaufhänger
ceiling hangers

Baugröße / Size
040 - 050 071 - 080

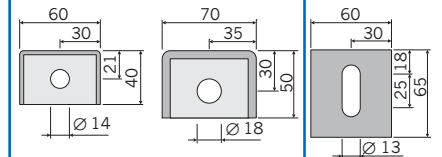

Fußplatte
base plate

040 - 080

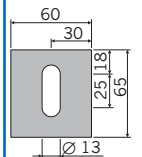

GHN.2 - 3 Ventilatoren - 3 Fans

Typ Type	Nennleistung Nominal capacity R404A		Fläche Surface	Luftvolumenstrom Air volume flow	Wurfweite ohne Streamer Air throw without Streamer	Wurfweite mit Streamer Air throw with Streamer	Schalldruck Sound pressure	Anschlüsse Connections				El. Abtauheizung El. defrost			Anschlussschema Connection diagram	aufgenommene elektrische Leistung power consumption P _{el} total	Anschlussklemmen optionale Ventilatorverkabelung connection terminals optional fan wiring	
	SC2 DT1 = 8 K t _b = - 8 °C	SC3 DT1 = 7 K t _b = - 25 °C						Kältemittel Refrigerant		400 V								
	kW	kW	m ²	m ³ /h	m	m	dB(A)/3m	Ein Inlet	Aus Outlet	Heißgas Block ein Hot gas coil inlet	Heißgas Wanne ein / aus Hot gas tray inlet / outlet	Block Coil	Tropfwanne Drip tray	Gesamt Total	W	W	kW	W
040.2D/34-ANW50	15,5	12,0	98,0	9180	13	29	57	16*	28,0	15	15	4800	1800	6,60	1 × B	0,65	1 × E	
040.2F/34-ANW50	20,0	16,2	147,0	8430	12	28	57	22*	42,0	22	22	8000	2400	10,40	1 × B	0,66	1 × E	
045.2D/34-ANW50	25,2	19,4	154,0	15330	18	38	60	22*	42,0	22	22	6900	3000	9,90	1 × B	1,49	1 × E	
045.2E/34-ANW50	29,6	23,8	192,4	14580	17	37	60	28*	54,0	22	22	9200	3000	12,20	1 × B	1,52	1 × E	
050.2D/34-ANS50	33,5	26,8	201,8	19950	22	43	60	28*	54,0	22	22	9600	3200	12,80	1 × B	1,55	1 × I	
050.2E/34-ANS50	38,7	31,1	252,3	19410	22	41	60	28*	54,0	22	22	12000	3200	15,20	1 × B	1,58	1 × I	
050.2F/34-ANS50	43,6	35,3	302,7	18900	21	39	60	28*	64,0	22	22	14400	4800	19,20	2 × B	1,61	1 × I	
071.2D/34-AND50	57,8	44,4	352,9	35280	37	67	58	28*	64,0	22	22	19000	6300	25,30	2 × C	2,39	3 × G	
071.2E/34-AND50	66,5	51,6	441,1	33690	37	66	58	28*	64,0	22	22	22800	6300	29,10	3 × C	2,42	3 × G	
071.2F/34-AND50	74,3	58,4	529,3	32370	36	64	58	35*	76,1	28	28	26600	6300	32,90	3 × C	2,46	3 × G	
080.2D/34-AND50	90,8	73,6	553,6	53910	45	78	67	2 x 28*	2 x 64	28	28	27000	8700	35,70	3 × C	4,04	3 × G	
080.2E/34-AND50	102,1	77,2	692,0	51840	44	76	67	35*	76,1	28	28	36000	8700	44,70	4 × C	4,07	3 × G	
080.2F/34-AND50	113,6	87,1	830,3	50160	43	74	67	42*	76,1	35	35	40500	8700	49,20	4 × C	4,08	3 × G	
040.2F/37-ANW50	16,6	12,9	86,5	9300	14	29	57	16*	35,0	22	22	8000	2400	10,40	1 × B	0,65	1 × E	
040.2H/37-ANW50	19,8	15,6	115,3	8790	13	28	57	22*	42,0	22	22	9600	2400	12,00	1 × B	0,65	1 × E	
045.2E/37-ANW50	24,0	19,0	113,2	15960	18	41	60	22*	42,0	22	22	9200	3000	12,20	1 × B	1,47	1 × E	
045.2F/37-ANW50	27,6	21,9	135,8	15570	17	40	60	22*	42,0	22	22	11500	4500	16,00	2 × B	1,49	1 × E	
045.2H/37-ANW50	32,0	24,9	181,1	14520	17	38	60	22*	42,0	22	22	16100	4500	20,60	2 × B	1,52	1 × E	
050.2F/37-ANS50	35,6	28,0	178,1	20100	23	43	60	28*	54,0	22	22	14400	4800	19,20	2 × B	1,52	1 × I	
050.2H/37-ANS50	42,3	33,6	237,4	19260	22	41	60	28*	64,0	22	22	21600	4800	26,40	2 × B	1,58	1 × I	
071.2E/37-AND50	54,5	43,0	259,5	36600	37	68	58	28*	64,0	22	22	22800	6300	29,10	3 × C	2,34	3 × G	
071.2F/37-AND50	63,1	50,2	311,4	35670	37	67	58	35*	76,1	28	28	26600	6300	32,90	3 × C	2,39	3 × G	
071.2H/37-AND50	75,0	60,4	415,2	33570	37	64	58	42*	76,1	28	28	34200	6300	40,50	4 × C	2,42	3 × G	
080.2E/37-AND50	83,8	65,0	407,0	55560	46	79	67	35*	76,1	28	28	36000	8700	44,70	4 × C	3,99	3 × G	
080.2F/37-AND50	96,6	75,4	488,4	54510	45	78	67	42*	76,1	35	35	40500	8700	49,20	4 × C	4,02	3 × G	
080.2H/37-AND50	114,7	91,4	651,2	51630	44	76	67	2 x 28*	2 x 64	35	35	54000	8700	62,70	5 × C	4,07	3 × G	
040.2F/310-ANW50	14,0	11,0	62,3	9630	15	30	57	16*	35,0	22	22	8000	2400	10,40	1 × B	0,62	1 × E	
040.2H/310-ANW50	17,3	13,7	83,1	9180	14	29	57	22*	42,0	22	22	9600	2400	12,00	1 × B	0,65	1 × E	
045.2E/310-ANW50	19,6	15,7	81,6	16590	18	42	60	22*	42,0	22	22	9200	3000	12,20	1 × B	1,44	1 × E	
045.2F/310-ANW50	23,0	18,5	97,9	16200	18	41	60	22*	42,0	22	22	11500	4500	16,00	2 × B	1,47	1 × E	
045.2H/310-ANW50	27,9	22,0	130,5	15210	17	39	60	22*	42,0	22	22	16100	4500	20,60	2 × B	1,49	1 × E	
050.2H/310-ANS50	36,2	28,0	171,1	19860	23	44	60	28*	54,0	22	22	21600	4800	26,40	2 × B	1,55	1 × I	
071.2E/310-AND50	43,6	33,1	187,0	37650	38	69	58	28*	54,0	22	22	22800	6300	29,10	3 × C	2,31	3 × G	
071.2F/310-AND50	52,6	42,2	224,4	36990	38	68	58	35*	76,1	28	28	26600	6300	32,90	3 × C	2,34	3 × G	
071.2H/310-AND50	65,0	52,5	299,2	35160	37	66	58	42*	76,1	28	28	34200	6300	40,50	4 × C	2,39	3 × G	
080.2F/310-AND50	80,6	63,8	352,0	55980	46	80	67	42*	76,1	35	35	40500	8700	49,20	4 × C	3,99	3 × G	
080.2H/310-AND50	100,2	80,1	469,3	53910	45	78	67	2 x 28*	2 x 64	35	35	54000	8700	62,70	5 × C	4,04	3 × G	
040.2F/312-ANW50	12,8	10,1	52,9	9900	16	29	57	16*	35,0	22	22	8000	2400	10,40	1 × B	0,62	1 × E	
040.2H/312-ANW50	16,0	12,8	70,6	9420	15	29	57	22*	42,0	22	22	9600	2400	12,00	1 × B	0,63	1 × E	
045.2E/312-ANW50	17,7	14,3	69,3	16950	19	42	60	22*	42,0	22	22	9200	3000	12,20	1 × B	1,43	1 × E	
045.2F/312-ANW50	20,7	16,3	83,1	16650	18	42	60	22*	42,0	22	22	11500	4500	16,00	2 × B	1,44	1 × E	
045.2H/312-ANW50	26,0	20,6	110,9	15780	18	40	60	22*	42,0	22	22	16100	4500	20,60	2 × B	1,47	1 × E	
050.2H/312-ANS50	33,4	26,1	145,3	20250	23	45	60	28*	54,0	22	22	21600	4800	26,40	2 × B	1,52	1 × I	
071.2E/312-AND50	39,6	30,5	158,8	38310	38	70	58	28*	54,0	22	22	22800	6300	29,10	3 × C	2,28	3 × G	
071.2F/312-AND50	47,7	38,4	190,6	37800	38	69	58	35*	76,1	28	28	26600	6300	32,90	3 × C	2,31	3 × G	
071.2H/312-AND50	59,1	46,0	254,1	36210	37	67	58	28*	64,0	28	28	34200	6300	40,50	4 × C	2,37	3 × G	
080.2F/312-AND50	73,1	58,3	298,9	57000	46	80	67	42*	76,1	35	35	40500	8700	49,20	4 × C	3,96	3 × G	
080.2H/312-AND50	92,2	74,0	398,6	54930	46	78	67	2 x 28*	2 x 64	35	35	54000	8700	62,70	5 × C	3,99	3 × G	

* Mehrfacheinspritzung
* Multiple injection 

GHN.2 - 3 Ventilatoren - 3 Fans												
Typ Type	Rohrvolumen Tube volume	Nettogewicht Net weight	Abmessungen Dimensions									Ablauf G-Gewinde flach- dichtend Drain G-thread flat sealing DIN-ISO 228-1
			L	B	H	E	F	C	M	S	A	
	l	kg	mm	mm	mm	mm	mm	mm	mm	mm	mm	K
040.2D/34-ANW50	15,2	105	2550	540	545	680	425	260	866	575	400	G1¼"
040.2F/34-ANW50	22,9	143	2550	815	555	680	700	260	866	850	400	G1¼"
045.2D/34-ANW50	23,4	134	3240	665	645	890	545	290	960	695	500	G1¼"
045.2E/34-ANW50	29,3	170	3240	665	645	890	545	290	960	695	500	G1¼"
050.2D/34-ANS50	30,5	183	3570	645	745	1000	545	290	1060	695	550	G1¼"
050.2E/34-ANS50	37,0	211	3570	645	745	1000	545	290	1060	695	550	G1¼"
050.2F/34-ANS50	45,7	245	3570	825	755	1000	700	290	1060	850	550	G1¼"
071.2D/34-AND50	52,4	435	4820	900	950	1360	715	380	1217	875	700	G2"
071.2E/34-AND50	64,0	481	4820	900	950	1360	715	380	1217	875	700	G2"
071.2F/34-AND50	78,5	546	4820	1050	960	1360	865	380	1217	1025	700	G2"
080.2D/34-AND50	81,5	592	5550	910	1250	1600	715	380	1517	875	700	G2"
080.2E/34-AND50	101,9	670	5550	910	1250	1600	715	380	1517	875	700	G2"
080.2F/34-AND50	122,3	819	5550	1060	1260	1600	865	380	1517	1025	700	G2"
040.2F/37-ANW50	22,9	128	2550	815	555	680	700	260	866	850	400	G1¼"
040.2H/37-ANW50	30,5	140	2550	815	555	680	700	230	866	850	400	G1¼"
045.2E/37-ANW50	29,3	150	3240	665	645	890	545	290	960	695	500	G1¼"
045.2F/37-ANW50	35,1	173	3240	815	655	890	700	290	960	850	500	G1¼"
045.2H/37-ANW50	46,8	193	3240	815	655	890	700	290	960	850	500	G1¼"
050.2F/37-ANS50	45,7	200	3570	825	755	1000	700	290	1060	850	550	G1¼"
050.2H/37-ANS50	58,7	243	3570	825	755	1000	700	290	1060	850	550	G1¼"
071.2E/37-AND50	64,0	386	4820	900	950	1360	715	380	1217	875	700	G2"
071.2F/37-AND50	78,5	495	4820	1050	960	1360	865	380	1217	1025	700	G2"
071.2H/37-AND50	104,7	539	4820	1050	960	1360	865	380	1217	1025	700	G2"
080.2E/37-AND50	101,9	592	5550	910	1250	1600	715	380	1517	875	700	G2"
080.2F/37-AND50	122,3	675	5550	1060	1260	1600	865	380	1517	1025	700	G2"
080.2H/37-AND50	163,1	751	5550	1060	1260	1600	865	380	1517	1025	700	G2"
040.2F/310-ANW50	22,9	121	2550	815	555	680	700	260	866	850	400	G1¼"
040.2H/310-ANW50	30,5	141	2550	815	555	680	700	230	866	850	400	G1¼"
045.2E/310-ANW50	29,3	142	3240	665	645	890	545	290	960	695	500	G1¼"
045.2F/310-ANW50	35,1	162	3240	815	655	890	700	290	960	850	500	G1¼"
045.2H/310-ANW50	46,8	192	3240	815	655	890	700	290	960	850	500	G1¼"
050.2H/310-ANS50	60,9	252	3570	825	755	1000	700	290	1060	850	550	G1¼"
071.2E/310-AND50	65,4	418	4820	900	950	1360	715	380	1217	875	700	G2"
071.2F/310-AND50	78,5	470	4820	1050	960	1360	865	380	1217	1025	700	G2"
071.2H/310-AND50	104,7	540	4820	1050	960	1360	865	380	1217	1025	700	G2"
080.2F/310-AND50	122,3	642	5550	1060	1260	1600	865	380	1517	1025	700	G2"
080.2H/310-AND50	163,1	751	5550	1060	1260	1600	865	380	1517	1025	700	G2"
040.2F/312-ANW50	22,9	117	2550	815	555	680	700	260	866	850	400	G1¼"
040.2H/312-ANW50	30,5	135	2550	815	555	680	700	230	866	850	400	G1¼"
045.2E/312-ANW50	29,3	135	3240	665	645	890	545	290	960	695	500	G1¼"
045.2F/312-ANW50	35,1	158	3240	815	655	890	700	290	960	850	500	G1¼"
045.2H/312-ANW50	46,8	187	3240	815	655	890	700	290	960	850	500	G1¼"
050.2H/312-ANS50	60,9	230	3570	825	755	1000	700	290	1060	850	550	G1¼"
071.2E/312-AND50	65,4	403	4820	900	950	1360	715	380	1217	875	700	G2"
071.2F/312-AND50	78,5	460	4820	1050	960	1360	865	380	1217	1025	700	G2"
071.2H/312-AND50	104,7	525	4820	1050	960	1360	865	380	1217	1025	700	G2"
080.2F/312-AND50	122,3	627	5550	1060	1260	1600	865	380	1517	1025	700	G2"
080.2H/312-AND50	163,1	731	5550	1060	1260	1600	865	380	1517	1025	700	G2"

Wandkonsolen für Typen 040.2, 045.2, 050.2
wall brackets for types

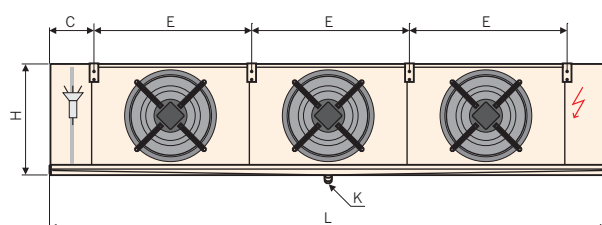
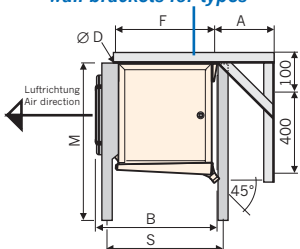

Deckenaufhänger
ceiling hangers

Baugröße / Size
040 - 050 071 - 080

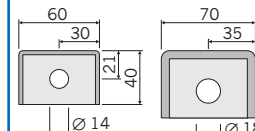

Fußplatte
base plate

040 - 080

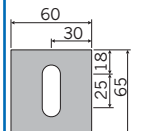

GHN.2 - 4 Ventilatoren - 4 Fans

Typ Type	Nennleistung Nominal capacity R404A		Fläche Surface	Luftvolumenstrom Air volume flow	Wurfweite ohne Streamer Air throw without Streamer	Wurfweite mit Streamer Air throw with Streamer	Schalldruck Sound pressure	Anschlüsse Connections				El. Abtauheizung El. defrost			Anschlusschema Connection diagram	aufgenommene elektrische Leistung power consumption P_{el} total	Anschlussklemmen optionale Ventilatorverkabelung connection terminals optional fan wiring
	SC2 $DT1 = 8 K$ $t_b = -8 °C$	SC3 $DT1 = 7 K$ $t_b = -25 °C$						Ein Inlet	Aus Outlet	Heißgas Block ein Hot gas coil inlet	Heißgas Wanne ein / aus Hot gas tray inlet / outlet	Block Coil	Tropfwanne Drip tray	Gesamt Total			
040.2D/44-ANW50	21,1	17,0	130,7	12240	14	31	58	22*	42,0	15	15	6900	2200	9,10	1 × B	0,86	1 × E
040.2F/44-ANW50	26,4	20,9	196,1	11240	13	30	58	22*	42,0	22	22	11500	3000	14,50	1 × B	0,88	1 × E
045.2D/44-ANW50	34,0	26,6	205,3	20440	19	40	61	22*	42,0	22	22	9300	3600	12,90	1 × B	1,98	1 × E
045.2E/44-ANW50	39,3	31,1	256,6	19440	18	39	61	28*	54,0	22	22	12400	3600	16,00	2 × B	2,02	1 × E
050.2D/44-ANS50	44,0	33,7	269,1	26600	23	45	61	28*	54,0	22	22	14000	3600	17,60	2 × B	2,06	1 × I
050.2E/44-ANS50	50,8	39,5	336,4	25880	23	43	61	28*	54,0	22	22	17500	3600	21,10	2 × B	2,10	1 × I
050.2F/44-ANS50	57,5	45,2	403,6	25200	22	41	61	28*	64,0	28	28	21000	5400	26,40	3 × B	2,14	1 × I
040.2F/47-ANW50	22,6	18,0	115,3	12400	15	31	58	22*	42,0	22	22	11500	3000	14,50	1 × B	0,86	1 × E
040.2H/47-ANW50	26,3	20,5	153,8	11720	14	30	58	22*	42,0	22	22	13800	3000	16,80	2 × B	0,87	1 × E
045.2E/47-ANW50	32,1	25,7	150,9	21280	19	43	61	28*	54,0	22	22	12400	3600	16,00	2 × B	1,96	1 × E
045.2F/47-ANW50	36,9	29,7	181,1	20760	18	42	61	28*	64,0	22	22	15500	5400	20,90	2 × B	1,98	1 × E
045.2H/47-ANW50	43,5	35,3	241,5	19360	18	40	61	28*	64,0	22	22	21700	5400	27,10	3 × B	2,02	1 × E
050.2F/47-ANS50	47,8	38,1	237,4	26800	24	45	61	28*	64,0	28	28	21000	5400	26,40	3 × B	2,02	1 × I
050.2H/47-ANS50	57,4	46,2	316,6	25680	23	43	61	35*	76,1	28	28	31500	5400	36,90	4 × B	2,10	1 × I
040.2F/410-ANW50	18,8	15,1	83,1	12840	16	32	58	22*	42,0	22	22	11500	3000	14,50	1 × B	0,83	1 × E
040.2H/410-ANW50	23,0	18,1	110,8	12240	15	31	58	22*	42,0	22	22	13800	3000	16,80	2 × B	0,86	1 × E
045.2E/410-ANW50	25,9	20,1	108,8	22120	19	44	61	22*	42,0	22	22	12400	3600	16,00	2 × B	1,92	1 × E
045.2F/410-ANW50	30,3	23,6	130,5	21600	19	43	61	22*	42,0	22	22	15500	5400	20,90	2 × B	1,96	1 × E
045.2H/410-ANW50	37,3	29,4	174,0	20280	18	41	61	28*	54,0	22	22	21700	5400	27,10	3 × B	1,98	1 × E
050.2H/410-ANS50	49,2	39,8	228,1	26480	24	46	61	35*	76,1	28	28	31500	5400	36,90	4 × B	2,06	1 × I
040.2F/412-ANW50	17,1	13,8	70,6	13200	17	31	58	22*	42,0	22	22	11500	3000	14,50	1 × B	0,82	1 × E
040.2H/412-ANW50	21,3	16,9	94,1	12560	16	31	58	22*	42,0	22	22	13800	3000	16,80	2 × B	0,84	1 × E
045.2E/412-ANW50	23,5	18,4	92,4	22600	20	44	61	22*	42,0	22	22	12400	3600	16,00	2 × B	1,90	1 × E
045.2F/412-ANW50	27,7	21,8	110,9	22200	19	44	61	22*	42,0	22	22	15500	5400	20,90	2 × B	1,92	1 × E
045.2H/412-ANW50	34,7	27,5	147,8	21040	19	42	61	28*	54,0	22	22	21700	5400	27,10	3 × B	1,96	1 × E
050.2H/412-ANS50	45,2	36,7	193,8	27000	24	47	61	35*	76,1	28	28	31500	5400	36,90	4 × B	2,02	1 × I

* Mehrfacheinspritzung 
 * Multiple injection

GHN.2 - 4 Ventilatoren - 4 Fans												
Typ Type	Rohrvolumen Tube volume	Nettogewicht Net weight	Abmessungen Dimensions									Ablauf G-Gewinde flach- dichtend Drain G-thread flat sealing DIN-ISO 228-1
			L	B	H	E	F	C	M	S	A	
	l	kg	mm	mm	mm	mm	mm	mm	mm	mm	mm	K
040.2D/44-ANW50	19,9	144	3230	540	545	680	425	260	866	575	400	G1¼"
040.2F/44-ANW50	29,8	189	3230	815	555	680	700	260	866	850	400	G1¼"
045.2D/44-ANW50	30,7	184	4130	665	645	890	545	290	960	695	500	G1¼"
045.2E/44-ANW50	38,3	231	4130	665	645	890	545	290	960	695	500	G1¼"
050.2D/44-ANS50	40,0	251	4570	645	745	1000	545	290	1060	695	550	G1¼"
050.2E/44-ANS50	48,5	288	4570	645	745	1000	545	290	1060	695	550	G1¼"
050.2F/44-ANS50	59,9	346	4570	825	755	1000	700	290	1060	850	550	G1¼"
040.2F/47-ANW50	29,8	170	3230	815	555	680	700	260	866	850	400	G1¼"
040.2H/47-ANW50	39,7	186	3230	815	555	680	700	230	866	850	400	G1¼"
045.2E/47-ANW50	38,3	206	4130	665	645	890	545	290	960	695	500	G1¼"
045.2F/47-ANW50	46,0	241	4130	815	655	890	700	290	960	850	500	G1¼"
045.2H/47-ANW50	61,3	267	4130	815	655	890	700	290	960	850	500	G1¼"
050.2F/47-ANS50	59,9	289	4570	825	755	1000	700	290	1060	850	550	G1¼"
050.2H/47-ANS50	79,9	344	4570	825	755	1000	700	290	1060	850	550	G1¼"
040.2F/410-ANW50	29,8	162	3230	815	555	680	700	260	866	850	400	G1¼"
040.2H/410-ANW50	39,7	187	3230	815	555	680	700	230	866	850	400	G1¼"
045.2E/410-ANW50	38,3	194	4130	665	645	890	545	290	960	695	500	G1¼"
045.2F/410-ANW50	46,0	201	4130	815	655	890	700	290	960	850	500	G1¼"
045.2H/410-ANW50	61,3	263	4130	815	655	890	700	290	960	850	500	G1¼"
050.2H/410-ANS50	79,9	346	4570	825	755	1000	700	290	1060	850	550	G1¼"
040.2F/412-ANW50	29,8	156	3230	815	555	680	700	260	866	850	400	G1¼"
040.2H/412-ANW50	39,7	178	3230	815	555	680	700	230	866	850	400	G1¼"
045.2E/412-ANW50	38,3	186	4130	665	645	890	545	290	960	695	500	G1¼"
045.2F/412-ANW50	46,0	217	4130	815	655	890	700	290	960	850	500	G1¼"
045.2H/412-ANW50	61,3	256	4130	815	655	890	700	290	960	850	500	G1¼"
050.2H/412-ANS50	79,9	329	4570	825	755	1000	700	290	1060	850	550	G1¼"

Wandkonsolen für Typen
wall brackets for types 040.2, 045.2, 050.2

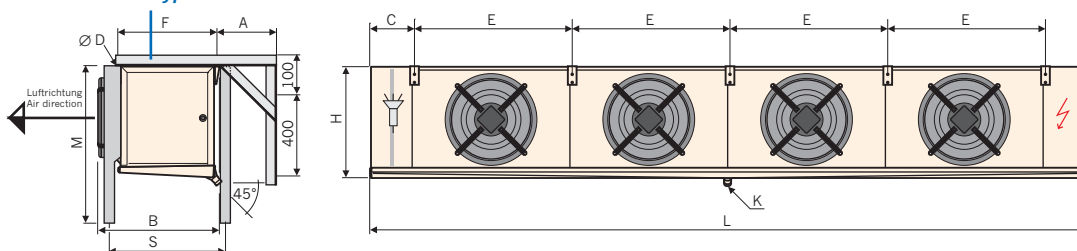

Deckenaufhänger
ceiling hangers

Baugröße / Size
040 - 050

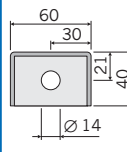

071 - 080

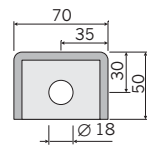

Fußplatte
base plate

040 - 080

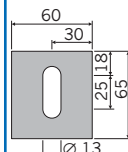

GHN.2 - Daten je Ventilator

GHN.2 - Nominal data per fan

Typ Type	Motordaten je Ventilator (Nennwerte) Motor data per fan (nominal values)					
	Ventilator Fan Ø	Anzahl Phase / Spannung / Frequenz Number of phases / voltage / frequency	Drehzahl Speed min ⁻¹	Typenschild- angaben Nameplate data W	Stromstärke Current A	Schallleistungspegel Sound power level dB(A)
040.2...	400	1/230/50	1390	225	1,05	74
045.2...	450	1/230/50	1360	475	2,2	78
050.2...	500	3/400/50	1410	620	1,85	78
071.2...	710	3/400/50	900	880	1,65	77
080.2...	800	3/400/50	890	1400	2,7	86

Anschlussschema

el. Abtauheizung und Ventilator

Connection diagram

electrical defrost and fan

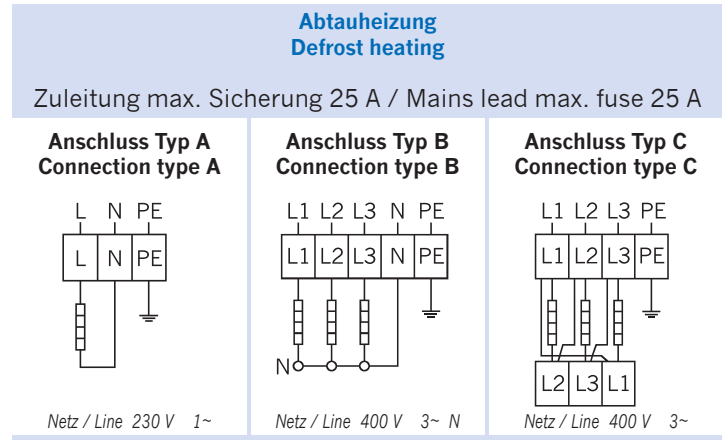

**Ventilator (*Werkseitige Verkabelung optional)
Fan (*optional: wiring ex works)**

**Anschluss Typ E
Connection type E**

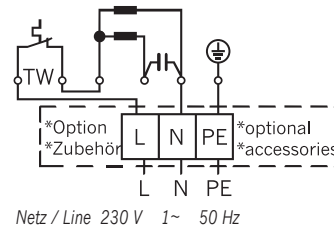

**Anschluss Typ G
Connection type G**

Netz / Line 400 V 3~ 50 Hz
Thermokontakt extern
external thermal contact

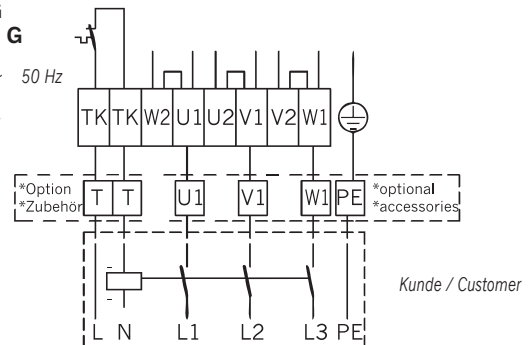

**Anschluss Typ I
Connection type I**

Netz / Line 400 V 3~ 50 Hz
Thermokontakt intern
internal thermal contact

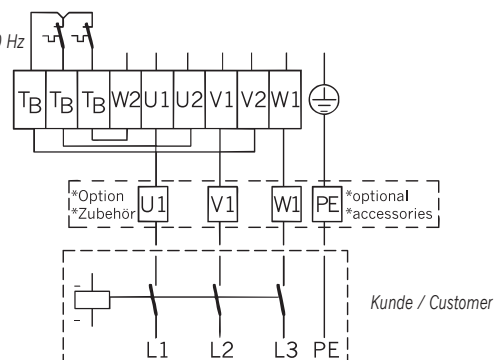

Korrekturfaktoren nach Eurovent

Correction factors acc. to Eurovent

Korrekturfaktoren (f_R)
für andere Kältemittel
nach Eurovent

Correction factors (f_R)
for other refrigerants
acc. to Eurovent

Kältemittel / Refrigerant	f_R	
	SC 2	SC 3
R507	0.97	0.97
R134a	0.91	0.85
R22	0.95	0.95

effektive Kälteleistung $\dot{Q}'_o = \text{nominale Kälteleistung } \dot{Q}_o \times \text{Korrekturfaktor } f_R$
actual refrigerating capacity $\dot{Q}'_o = \text{nominal refrigerating capacity } \dot{Q}_o \times \text{correction factor } f_R$

SC2 = Standard condition DT1 = 8 K, $t_o = -8^\circ\text{C}$
SC3 = Standard condition DT1 = 7 K, $t_o = -25^\circ\text{C}$

Korrekturfaktoren (f_M)
für andere Lamellenmaterialien
nach Eurovent

Correction factors (f_M)
for other fin materials
acc. to Eurovent

Lamellenmaterial / Fin material	f_M Faktor / Factor
Aluminium / aluminium	1
Aluminium beschichtet / coated aluminium	0.97

effektive Kälteleistung $\dot{Q}'_o = \text{nominale Kälteleistung } \dot{Q}_o \times \text{Korrekturfaktor } f_M$
actual refrigerating capacity $\dot{Q}'_o = \text{nominal refrigerating capacity } \dot{Q}_o \times \text{correction factor } f_M$

Güntner Product Calculator die bessere Wahl

Güntner Product Calculator the perfect choice

Für eine **genaue thermodynamische Auslegung** mit anderen Betriebsbedingungen (auch für andere Kältemittel, Luftfeuchte und Epoxidharz-beschichtete Lamellen) empfehlen wir die Verwendung des **Güntner Product Calculator**.

We recommend using the **Güntner Product Calculator** for an **exact thermodynamic design** in different conditions (also for other refrigerants, air humidity and epoxy resin coated fins).

Kältemittel Refrigerant

Luftfeuchte Air humidity

Epoxidharz beschichtete Lamellen Epoxy resin coated fins

Kühlerblock Cooler coil

Lamellen aus Aluminium, Rohrteilung 50 × 50 mm fluchtend, innenberippte Spezialkupferrohre Ø 15 mm. Lamellenteilung 4, 7, 10 und 12 mm Die kältemittelführenden Kernrohre sind durch die bewährte Güntner Tragrohrkonstruktion entlastet. Dadurch ergibt sich eine erhöhte Sicherheit gegen Undichtigkeit.

Fins made of aluminium, tube pattern aligned 50 × 50 mm, special copper tubes, internally grooved Ø 15 mm. Fin spacing 4, 7, 10 and 12 mm The fluid-carrying core tubes are stressed less due to Güntner's tried and tested floating coil principle. This results in increased safety against leakage.

Gehäuse Casing

Baugröße 040 – 050: AlMg3, Pulverbeschichtet RAL 9003 (Signalweiß), Baugröße 071 – 080: Stahl verzinkt, Pulverbeschichtet RAL 9003 (Signalweiß), durch aufklappbare Seitenverkleidung einfacher Zugang zu den Anschlüssen.

Sizes 040 – 050: AlMg3, powder-coated, RAL 9003 (signal white), Sizes 071 – 080: galvanised steel, powder-coated RAL 9003 (signal white), connections are easily accessible due to hinged side covering.

Tropfwanne Drip tray

AlMg3, Pulverbeschichtet RAL 9003 (Signalweiß) Zur leichteren Reinigung ist die Tropfwanne abklapp- bzw. abnehmbar. Einwandfreier Tauwasserablauf durch optimal gestalteten Ablauf. Ablaufstutzen unter 45° montiert, mit G-Gewinde flachdichtend nach DIN-ISO 228-1.

AlMg3, powder-coated, RAL 9003 (signal white) For easy cleaning the drip tray can be folded down or removed. Perfect condensation water drain due to optimal drain design. Drain nozzle mounted at an angle below 45°, with G-thread flat sealing acc. to DIN-ISO 228-1.

Ventilatoren Fans

Geräuscharme Axialventilatoren mit wartungsfreien Motoren mit Schutzart IP 54, ISO F und DIN VDE 0530, Wuchtgüte Q 6,3 n. VDI 2060, Schutzgitter gemäß EN 294 Drehstrom 400 V 3~ 50 Hz bzw. Wechselstrom 230 V 1~ 50 Hz, zulässige Lufttemperatur (Einsatzbereich) –30 °C bis +45 °C. Wir behalten uns vor, verschiedene Ventilatorfabrikate einzusetzen. Je nach Ventilatorfabrikat können die Motordaten geringfügig abweichen. Die entsprechenden elektrischen Daten müssen dem Typenschild entnommen werden, elektrische Leistungsangaben gemäß EN 328. Die Stromaufnahme erhöht sich mit tiefer Umgebungstemperatur und höheren Gegendrücken. Der Motorschutz muss über die eingebauten Thermokontakte (Öffner) erfolgen.

Low-noise axial fans, with maintenance-free motors in protection class IP 54, ISO F and DIN VDE 0530, balance quality Q 6.3 acc. to VDI 2060, protection guard acc. to EN 294 three-phase current 400 V 3~ 50 Hz or alternating current 230 V 1~ 50 Hz, admissible air temperature (operating range) –30 °C to +45 °C. We reserve the right to use fans of different manufacturers. Depending on the fan type, the motor data may slightly vary. For the corresponding electrical data, please refer to the nameplate, electrical capacity specifications acc. to EN 328. At low ambient temperatures and different air resistance the power consumption will increase. The built-in thermal contacts (thermistors) must be used as motor protection.

Bei werkseitiger Verkabelung der Ventilatoren auf Klemmkasten oder Reparaturschalter der Baugrößen 040 – 050 sind die Thermokontakte bereits intern verschaltet (s. Anschlussschema).

If the fans for the sizes 040-050 are pre-wired at factory to the terminal box or the isolator switch, the thermal contacts are already internally wired (see connection diagram).

Schallangaben Sound specifications

Nach Standardverfahren zur Berechnung des Schalldruckpegels gemäß EN 13487; Anhang C (normativ). Da Kühlräume nur ein sehr geringes Absorptionsverhalten aufweisen, empfehlen wir, mit einer nur geringen Abnahme des Schalldruckpegels in größeren Entfernungen zu rechnen.

In compliance with the standard procedure for calculation of sound pressure level acc. to EN 13487; annex C (normative). As cooling rooms only have a very low absorbing capacity, we recommend to count with only a slight reduction in the sound pressure level for greater distances.

Abtaung Defrosting

gegen Mehrpreis wahlweise:

- Elektrisch, nach VDE Bestimmungen, Abtauleistung reduzierbar durch einfaches Umklemmen, Typenbezeichnung: GHN..../...-E
- Heißgas unverrohrt, Typenbezeichnung: GHN..../...-H
- Heißgas verrohrt, inkl. Rückschlagventil.

available on request at additional charge:

- Electrical acc. to VDE regulations, may be reduced through simple reconnection
Type designation: GHN..../...-E
- Hot gas, without tubing
Type designation: GHN..../...-H
- Hot gas, with tubing, incl. non-return valve

Leistungsangaben Capacity



Die Leistungsangaben gelten für R404A. Die Kühlerleistungen beziehen sich dabei auf eine Lufteintrittstemperaturdifferenz, die sich aus der Differenz zwischen Lufteintrittstemperatur am Kühler t_{L1} und Verdampfungstemperatur t_o , $DT1 = t_{L1} - t_o$ ergibt. Diese Bedingungen sind mit DT1 gekennzeichnet und entsprechen den Vorgaben der EN 328 und der Eurovent Organisation. Die zertifizierten Leistungsangaben sind im Katalog durch das Eurovent Symbol  gekennzeichnet.

The capacity specifications are valid for R404A. The refrigerating capacities refer to an air inlet temperature difference which results from the difference between cooler air inlet temperature t_{L1} and evaporating temperature t_o , $DT1 = t_{L1} - t_o$. These conditions are marked with DT1 and comply with the guidelines of EN 328 and Eurovent Organisation. In the catalogue the certified capacity data specifications are marked with the Eurovent symbol .

Mit unserer Auslegungssoftware **Güntner Product Calculator** erhalten Sie eine **genaue thermodynamische Auslegung** der gewünschten Gerätevariante mit anderen Betriebsparametern (auch für andere Kältemittel, Luftfeuchte und Epoxidharzbeschichtete Lamellen).

We recommend using our software package **Güntner Product Calculator** for an **exact thermodynamic design** in different operating conditions (also for other refrigerants, air humidity values and epoxy resin coated fins).

Verpackung Packaging

Die Geräte werden in Einbaulage verpackt mit montierter Wanne geliefert.

The units are delivered packaged in installation position with mounted drip tray.

Anmerkung Notes

Beim Einsatz der Kühler im Tief-temperaturbereich empfehlen wir elektrische Ringheizung für die Ventilatoren. Bei Betrieb der Geräte unter $t_o = -40\text{ °C}$ wegen der speziellen Materialanforderung und -auswahl bitte Rücksprache mit dem Vertrieb halten. Alle elektrischen Teile sind entsprechend den EN-Normen ausgeführt. Andere Rohrwanddicken und Lamellenteilungen sind auf Anfrage lieferbar.

In case of use of the coolers for low temperatures, we recommend an electrical ring heater for the fans. For unit operation below $t_o = -40\text{ °C}$ please consult our sales department because of the special material requirement and selection. All electrical parts are in compliance with the EN-standards. Other tube wall thicknesses and fin spacings on request.

Zubehör Accessories

(gegen Mehrpreis lieferbar)

- Elektrische Abtaugung für Block und Wanne
- Elektrische Ventilator-Ringheizung
- Aufstellfüße
- Wandkonsolen (Typen 040.2, 045.2, 050.2)
- Güntner Streamer
- Anschluss für Luftverteilschlauch
- Abtauklappe
- Reparaturschalter für Ventilatoren
- Verkabelung der Ventilatoren auf gemeinsamen Klemmkasten

(available at additional charge)

- Electric defrost in coil and drip tray
- Electrical fan ring heaters
- Feet for floor mounting
- Wall brackets (Types 040.2, 045.2, 050.2)
- Güntner Streamer
- Connection for air distribution sock
- Defrost flap
- Repair switch for fans
- Wiring of fans on conjoint terminal box

Zubehörteile verändern die Funktion des Gerätes.

Accessories change the function of the unit.

Optionen und Varianten Options and variants

- Expansionsventil werkseitig eingebaut
- Heißgas Block- und Wanneneheizung
- Rückschlagventil verrohrt
- Isolierte Wanne
- Verstärkte Ventilatoren
- Gehäuse in Edelstahl
- Epoxidharz-beschichtete Aluminium Lamellen
- Schwenkbare Ventilatereinheit
- Edelstahlrohre
- Wasserabtaugung

- Expansion valve installed ex works
- Hot gas defrost in coil and tray
- Check valve, tubed
- Insulated drip tray
- Reinforced fans
- Casing made of stainless steel
- Epoxy resin coated aluminium fins
- Swiveling fans
- Tubes made of stainless steel
- Water spray defrost