



Modularity, functionality and high performance are the main technical characteristics of the AIR PREPARATION EQUIPMENT presented by UNIVER.

CONSTRUCTION MATERIALS

- Main body: die-cast aluminium
- Knob: ABS
- Cover: ABS
- Bowl: polycarbonate
- Filter element: synthetic fibre
- Seals: NBR
- Springs: zinc plated steel
- Diaphragm: fabric reinforced rubber
- Ring nut: ABS
- Bowl guard: ABS

PRESSURE SETTINGS

In the catalogue pressure settings are indicated in bar. To transform values into MPa or psi the conversion factors are:

0,1 MPa = 1 bar
14,5038 Psi = 1 bar

OPERATING FEATURES

Functionality

The components have been manufactured to permit full disassembly for thorough cleaning or replacement.:

- quick release bowl with bayonet connection;
- filter element inserted on the deflector and screwed on;
- automatic drain instead of manual drain for size 1 and 2. Not provided in size 0. To replace, unscrew the ring nut and free the drain lip, push upwards to remove, insert replacement and re-lock;
- high rate of condensation separation: to drain use a \varnothing 6 mm tube;
- the regulator knob can be easily removed by unscrewing the ring nut to allow access to the regulator mechanism (size 1 and 2);
- threaded gauge connection is incorporated: the codes do not include gauges which must be ordered separately (see page 34).

Modularity

The various parts' can be easily combined by using the appropriate assembly kit. The part's bodies have bore holes for wall-mounting. The regulator can also be mounted by using a flat wall bracket or an L-shaped wall bracket which is locked by a ring nut under the knob and positioned in place by two pins opposite each other which will keep it from rotating.

Pressure adjustment

Pressure, even high pressure, can easily be adjusted with one hand only. To adjust it, pull the knob and turn it clockwise or anti-clockwise. When finished, push the knob upwards to block the pressure at the level reached. Adjust the working pressure after checking the supply pressure.

Before performing any maintenance operation, make sure that there is no pressure in the system.

Lubrication control

Through the graduated glass bubble the oil drops can be seen from any position.

Oil topping up

Done through the cap on the lubricator - no tools needed (size 1 and 2).

Topping up of size 0 is done by removing the bowl with guard.

This can be done also while the system is under pressure.

Fast bowl removal

The disassembly is done by pushing the guard upwards while turning it one quarter to the left.

The bowl comes away from the guard and presses against the diametrically opposite tabs.

Before removing the bowl and the guard, make sure that there is no pressure in the system.

O-ring

It is housed in the bowl which keeps it from moving and ensures the seal.

Technical tests

The technical tests on flow and pressure were done according to **UNI - 6358** using a diaphragm measuring instrument according to **ISO - 5167**.

Pneumatic scheme

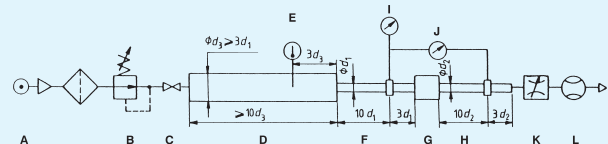

- A = Supply assembly and filter
- B = Adjustable pressure regulator
- C = Isolation valve
- D = Temperature measurement tube
- E = Temperature gauge
- F = Upstream pressure measurement tube
- G = Part under testing
- H = Upstream pressure measurement tube
- I = Upstream pressure gauge
- J = Differential pressure gauge
- K = Flow control valve
- L = Flow meter

Summary table of flow rates:

Flow Qn (NI/min)

Model							
		F	R	L	FR	F+R+L	FR+L
Key code references							
Size	Ports	F	R	L	B	C	D
0	G 1/4	1300	1100	1450	1000	931	920
1	G 1/4	2460	1480	3230	1360	960	1010
1	G 3/8	3040	1900	4440	1620	1230	1330
1	G 1/2	3570	2320	5610	1890	1450	1680
2	G 3/8	4770	2430	6190	3010	1870	1910
2	G 1/2	5550	3220	7240	3950	2070	2320
2	G 3/4	5750	3430	7540	4180	2120	2420

Product compatibility

The table indicates products which are not compatible with the material used in manufacturing the air preparation equipment. The FRL series made with AISI 316L stainless steel can be used for those products (ask our sales office for the specific catalogue).

Type	Classification	Main products	Main application
Inorganic compounds	acid	hydrochloric acid, sulphuric acid, nitric acid, hydrofluoric acid, phosphoric acid, chromic acid, etc.	pickling solution, acidic decreasing solution, film treatment solution etc. for metals
	alkalis	alkaline substances such as caustic soda, caustic potash, calcium hydroxide, ammonia water, sodium carbonate	alkaline degreasing solution for metals
	mineral salts	sodium sulphide, potassium nitrate, potassium bichromate, sulphate of soda, etc.	
Organic compounds	aromatic hydrocarbons	benzene, toluene, xylene, ethylbenzene, styrene, etc.	contained in solvents for paints (benzene, toluene, xylene)
	chlorinated aliphatic hydrocarbons	methyl chloride, ethyl chloride, methylene chloride, acetylene chloride, chloroform	organic solvents cleaning solutions
	chlorinated aromatic hydrocarbon	chlorobenzene, dichlorobenzene, hexachloride benzene (B.H.C.) etc.	pesticides
	petroleum product	solvent, diesel oil, gasoline	
	alcohol	methyl alcohol, ethyl alcohol, cyclohexanol, benzyl alcohol	used as antifreeze
	phenol	carbolic acid, cresol, naphthol, etc.	antiseptic solution
	ether	methyl ether, methyl ethyl ether, ethyl ether	additive for brake fluids
	ketone	acetone, methyl ketone, cyclohexanone, acetophenone, etc.	
	carboxylic acid	formic acid, acetic acid, butyric acid, acrylic acid, oxalic acid	dyeing agent: oxalic acid is used for treating aluminium whereas phthalic acid is used as a base for paints.
	phosphate ester	dimethyl phthalate (DMP), diethyl phthalate (DEP) dibutyl phthalate (DBP), dioctyl phthalate, (DOP)	used as additives for lubricants, synthetic hydraulic oils, anti-corrosive oils and plasticizers of synthetic resin
	oxyacid	glycolic acid, lactic acid, malic acid, citric acid, tartaric acid	
	nitro compound	nitromethane, nitroethane, nitroethylene, nitrobenzene, etc.	
	amine	methylamine	brake fluid additive
nitrile	acetonitrile, acrylonitrile, benzonitrile	raw material for nitrile rubber	

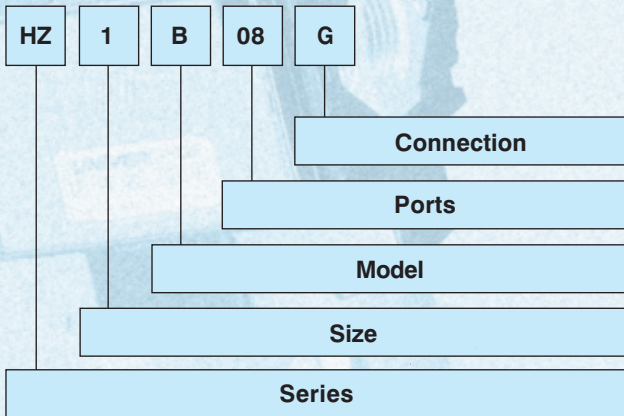

SERIES

HZ = Air preparation equipment

SIZE

0 = G 1/4
 1 = G 1/4 - G 3/8 - G1/2
 2 = G 3/8 - G 1/2 - G 3/4

MODEL

B = Filter regulator
 C = F+R+L
 D = B+L
 F = Filter
 G = Coalescing filter
 L = Lubricator
 M = Gradual starter
 N = Diverter block
 P = Lockable 3/2 valve
 PS = Lockable 3/2 valve with silencer and oversize drain
 R = Regulator
 RL = Lockable regulator

PORTS

08 = 1/4
 10 = 3/8
 15 = 1/2
 20 = 3/4

CONNECTIONS

G = GAS
 N = NPT (Size HZ0 excluded)

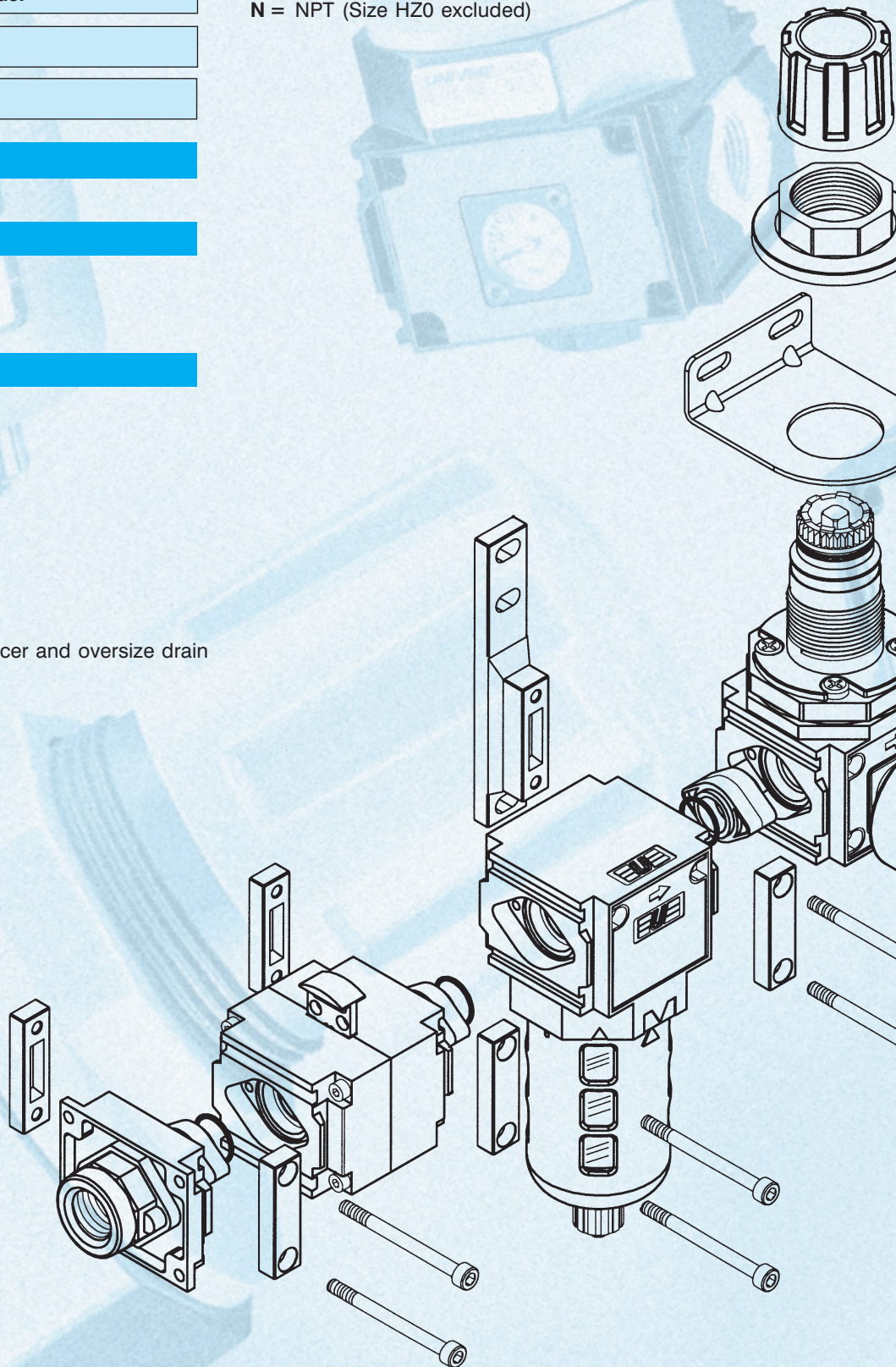

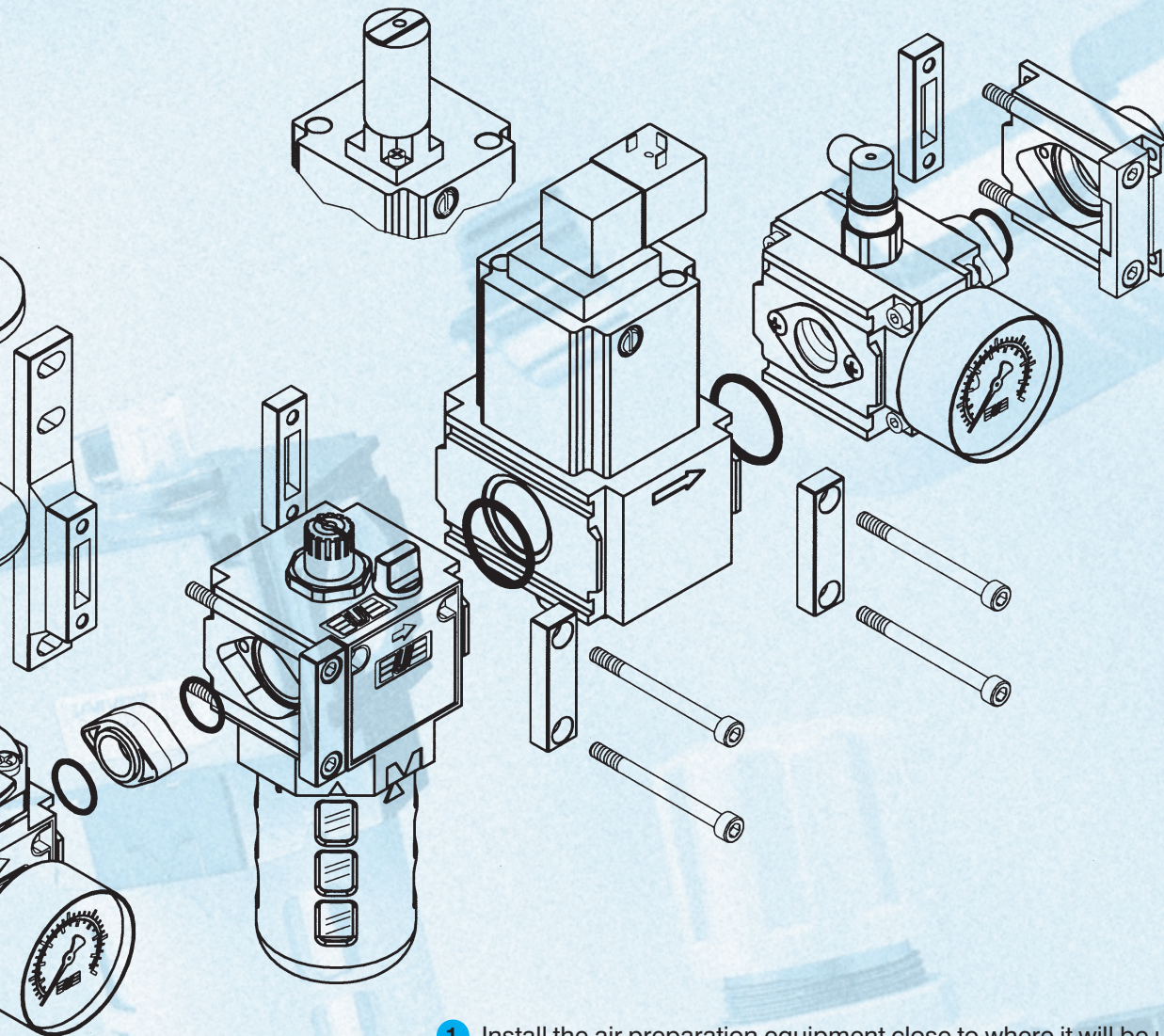

- 1 Install the air preparation equipment close to where it will be used.
- 2 The correct sequence for assembling the parts is F+R+L / FR+L.
- 3 The parts are unidirectional and the correct direction for the air flow is shown by an arrow marked on each component.
- 4 **Before servicing, depressurize the system. Exception may be made for topping up the oil which can be done when the system is under pressure. We therefore suggest the installation of a three-way valve upstream from the air preparation equipment.**
- 5 **For correct use of the regulator, the pressure must always be adjusted upwards.**
- 6 The use of ISO VG 32 oil is recommended for the lubricator.
- 7 **Attention:** in topping up do not use detergent oils or braking circuit oils.
- 8 For correct lubrication turn the knob of the lubricator so that oil flows at a rate of one drop per 300/600 NI.



manual drain



automatic drain

Technical characteristics

	HZ0F ... Size 0	HZ1F ... Size 1	HZ2F ... Size 2
Threaded port	G 1/4	G 1/4 - G 3/8 - G 1/2	G 3/8 - G 1/2 - G 3/4
Filtration rating μm	20 (upon request: 5-50)	5 (upon request: 20-50)	
Flow rate Nl/min (6 bar inlet pressure, 5 bar outlet pressure - Δp 1 bar)	1300	G 1/4 - 2460	G 3/8 - 4770
		G 3/8 - 3040	G 1/2 - 5550
		G 1/2 - 3570	G 3/4 - 5750
Max. inlet pressure bar - MPa - psi	10 - 1 - 145		
Fluid	compressed air		
Min/max temperature $^{\circ}\text{C}$	5 ÷ 60		
Condensation drain capacity cm^3	12	40	70
Condensation drain	manual	manual (upon request: automatic)	
Weight in kg	0,10	0,40	0,66
Foreseen for wall bracket mounting with screws	M3x40	M4 x 60	M4 x 70
Mounting position	vertical		

Accessories and spare parts on pages 24 and 25.



HZ0F ...



HZ1F ...
HZ2F ...

The correct assembly sequence is
F+R+L.

Before servicing,
depressurize
the system.

Filter with coalescing
cartridge
0,3 μm . (HZ1G...
HZ2G...)

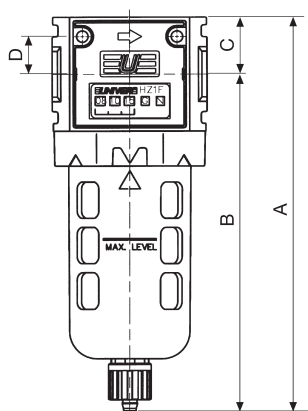
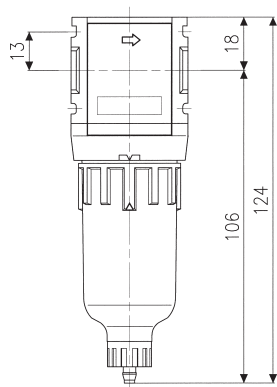
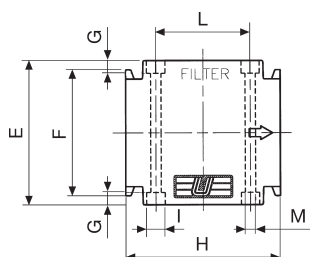
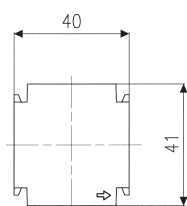

Overall dimensions

	Size 1	Size 2
A	173	197
B	148	172
C	25	25
D	16,5	19
E	63	80
F	55	72
G	5,5	5,5
H	67	83
I	8	8
L	41	57
M	$\text{Ø}4,5$	$\text{Ø}4,5$



Flow rate characteristics

HZ0F ... Size 0

G 1/4

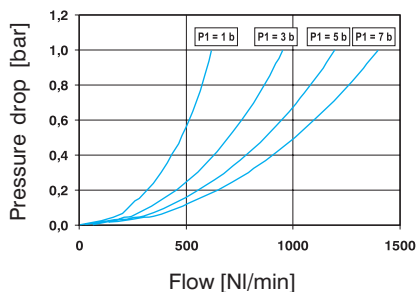

HZ1F ... Size 1

G 1/4

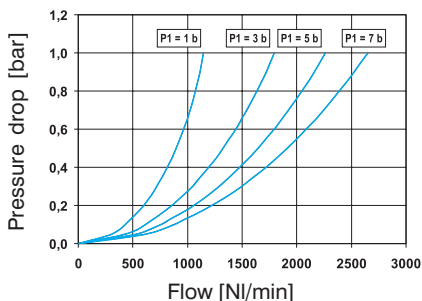

HZ2F ... Size 2

G 3/8

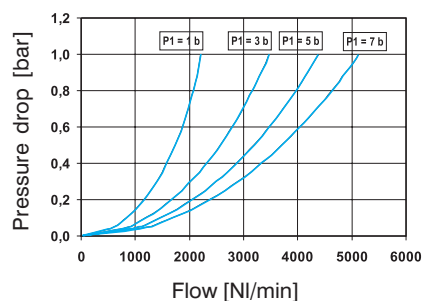

G 3/8

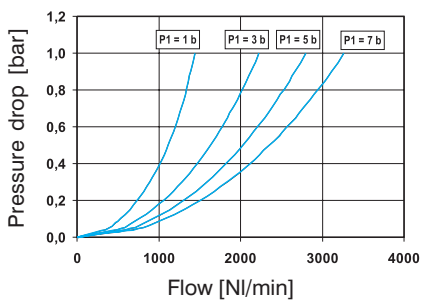

G 1/2

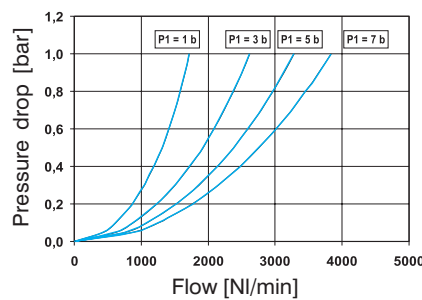

G 1/2

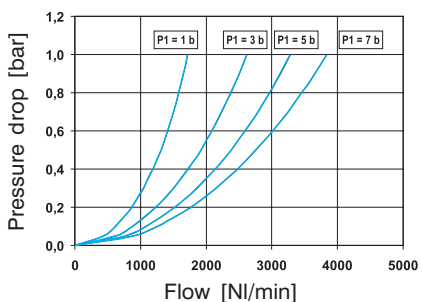

G 3/4

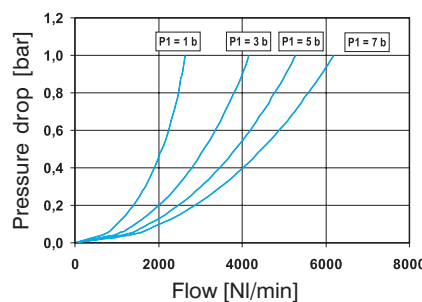

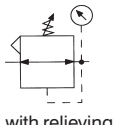

with relieving

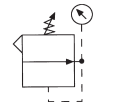

without relieving

Technical characteristics

	HZ0R ... Size 0	HZ1R ... Size 1	HZ2R ... Size 2
Threaded port	G 1/4	G 1/4 - G 3/8 - G 1/2	G 3/8 - G 1/2 - G 3/4
Flow rate NI/min (7 bar inlet pressure, 6 bar outlet pressure - Δp 1 bar)	1100	G 1/4 - 1480 G 3/8 - 1900 G 1/2 - 2320	G 3/8 - 2430 G 1/2 - 3220 G 3/4 - 3430
Max. inlet pressure bar - MPa - psi		10 - 1 - 145	
Pressure adjustment by relieving bar		0,5 ÷ 8,5	
Pressure gauge port		G 1/4	
Fluid		filtered air	
Min/max temperature °C		5 ÷ 60	
Weight in kg	0,10	0,55	0,93
Foreseen for wall bracket mounting with screws	M3x40	M4 x 60	M4 x 70
Mounting position	vertical / horizontal		

Accessories and spare parts on pages 24 and 25.

HZ0R ...

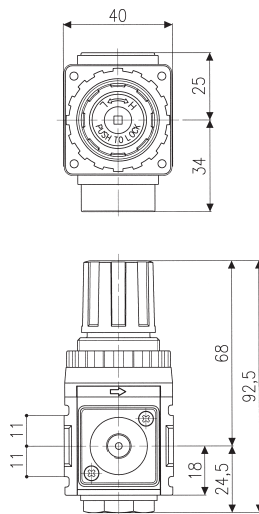

The L - bracket has two pins which prevent the regulator from rotating.

Before servicing, release the pressure from the system.

HZ1R ...
HZ2R ...

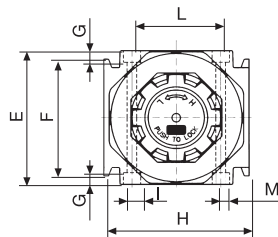

For correct use, pressure must always be adjusted upwards.

HZ1RL ...
HZ2ZL ...



Lockable regulator: lock standard supplied

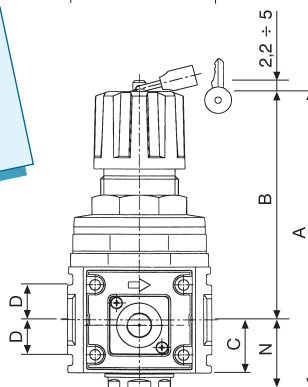

Overall dimensions

	Size 1	Size 2
A	140,5	153
B	108	116
C	25	25
D	16,5	19
E	63	80
F	55	72
G	5,5	5,5
H	67	83
I	8	8
L	41	57
M	Ø 4,5	Ø 4,5
N	32,5	37

The codes do not include the pressure gauges which must be ordered separately. See page 26.



Flow rate characteristics

HZ0R ... Series 0

G 1/4

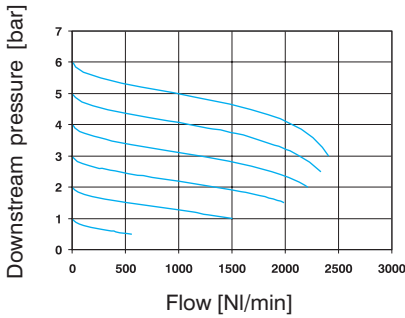

HZ1R ... Series 1

G 1/4

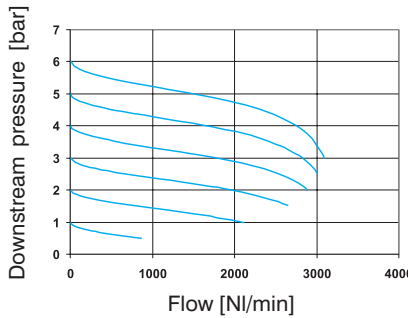

HZ2R ... Series 2

G 3/8

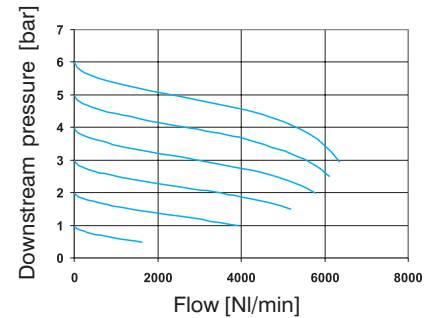

G 3/8

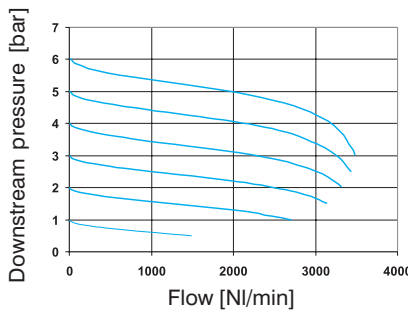

G 1/2

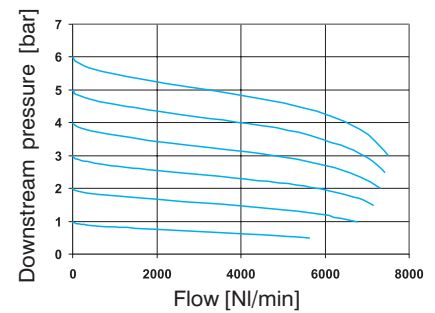

G 1/2

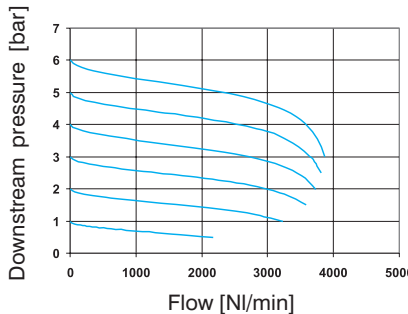

G 3/4

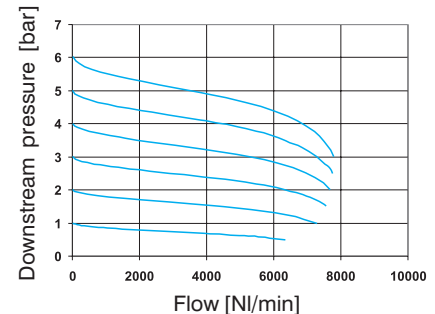

The flow rate characteristics are obtained as follows:

- 1) constant supply pressure (7 bar)
- 2) for each pressure setting (1 - 6 bar) the pressure reducer should be correspondingly set at zero pressure.
- 3) without adjusting the regulator, flow is progressively increased whilst checking downstream pressure.

Pressure characteristics

The curve shows the trend of the pressure adjusted to the changing pressure supply.

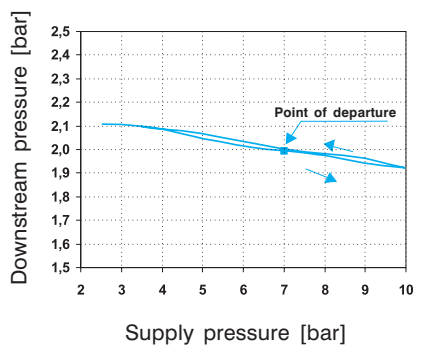
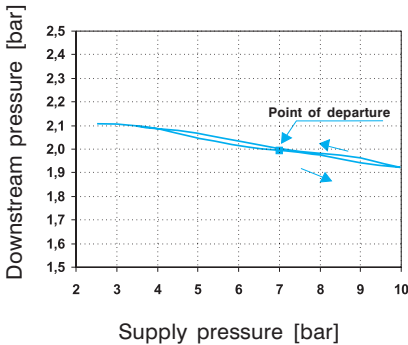
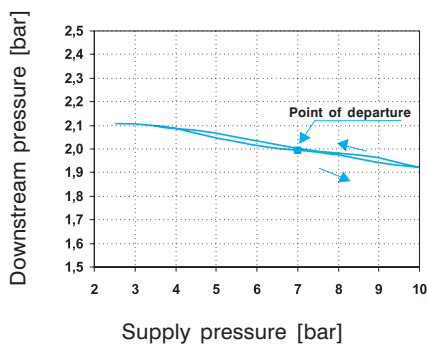

Special features of the UNIVER Regulator: • downstream pressure is kept constant even when upstream pressure varies • quick and responsive regulator servicing • fast elimination of downstream excess pressure.



Technical characteristics

	HZ0L ... Series 0	HZ1L ... Series 1	HZ2L ... Series 2
Threaded port	G 1/4	G 1/4 - 3/8 - G 1/2	G 3/8 - G 1/2 - G 3/4
Flowrate NI/min (6 bar inlet pressure, 5 bar outlet pressure - Δp 1 bar)	1450	G 1/4 - 3230 G 3/8 - 4440 G 1/2 - 5610	G 3/8 - 6190 G 1/2 - 7240 G 3/4 - 7540
Max. inlet pressure bar - MPa - psi	10 - 1 - 145		
Fluid	filtered air		
Min/max. temperature °C	5 ÷ 60		
Bowl capacity cm ³	20	85	170
Weight in kg	0,10	0,40	0,65
Foreseen for wall bracket mounting with screws	M3 x 40	M4 x 60	M4 x 70
Mounting position	vertical		
Recommended oil	ISO VG 32		
Minimum working flow l/min.	25	30	65

Accessories and spare parts on pages 24 and 25.

HZ0L ...

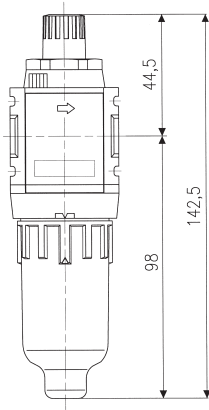
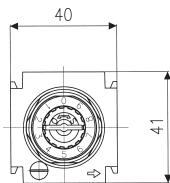

HZ1L ...
HZ2L ...

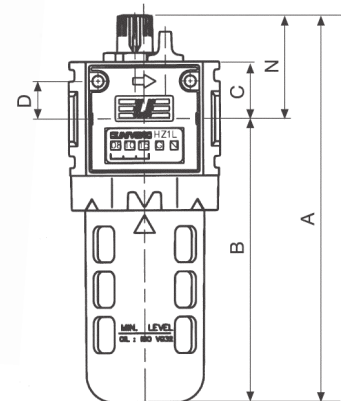
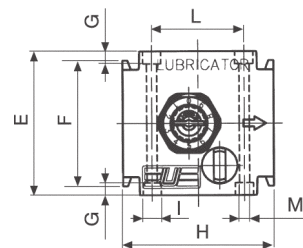

The correct assembly sequence is **F+R+L / FR+L.**

Oil can be topped up when the system is under pressure.

Before servicing, depressurize the system.

Recommended oil: **ISO VG 32**, at the rate of one drop per 300-600 NI.

Overall dimensions

	Size 1	Size 2
A	170,5	195,5
B	125	149
C	25	25
D	16,5	19
E	63	80
F	55	72
G	5,5	5,5
H	67	83
I	8	8
L	41	57
M	Ø 4,5	Ø 4,5
N	45,5	46,5



Flow rate characteristics

HZ0L ... Size 0

G 1/4

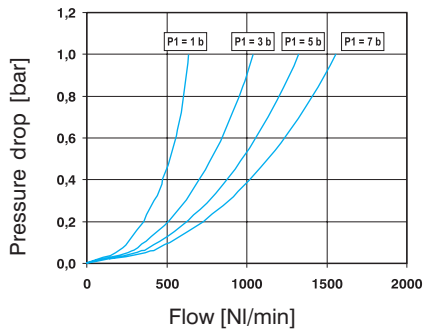

HZ1L ... Size 1

G 1/4

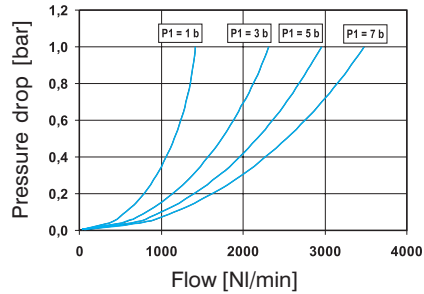

HZ2L ... Size 2

G 3/8

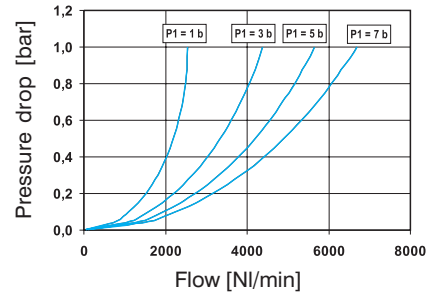

G 3/8

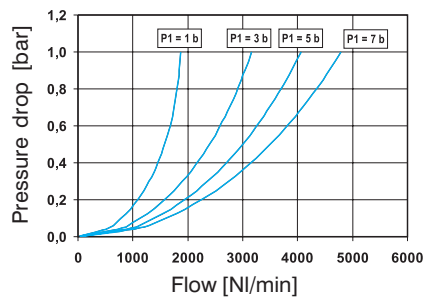

G 1/2

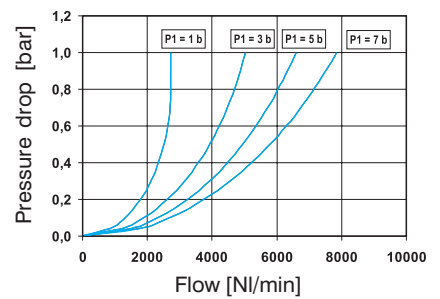

G 1/2

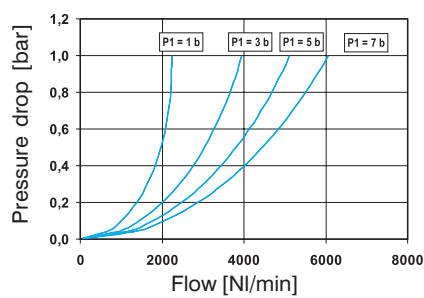

G 3/4

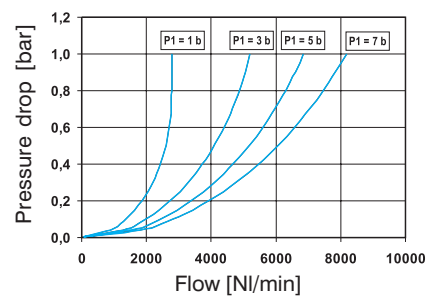

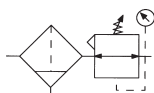

Technical characteristics

	HZ0B ... Size 0	HZ1B ... Size 1	HZ2B ... Size 2
Threaded port	G 1/4	G 1/4 - G 3/8 - G 1/2	G 3/8 - G 1/2 - G 3/4
Filtration rating μm	5 (upon request: 20-50)		
Flow rate Nl/min (7 bar inlet pressure, 6 bar outlet pressure - Δp 1 bar)	1000	G 1/4 - 1360 G 3/8 - 1620 G 1/2 - 1890	G 3/8 - 3010 G 1/2 - 3950 G 3/4 - 4180
Max. inlet pressure bar - MPa - psi	10 - 1 - 145		
Pressure adjustment by relieving bar	0,5 ÷ 8,5 (upon request: 0,5 ÷ 1,7 - 0,5 ÷ 3,5)		
Fluid	compressed air		
Min/max. temperature $^{\circ}\text{C}$	5 ÷ 60		
Condensation drain capacity cm^3	12	40	70
Condensation drain	manual	manual (upon request: automatic)	
Weight in kg	0,20	0,70	1,15
Foreseen for wall bracket mounting with screws	M3x40	M4 x 60	M4 x 70
Mounting position	vertical		
Pressure gauge port	G 1/8	G 1/4	

Accessories and spare parts on pages 24 and 25.

HZ0B ...

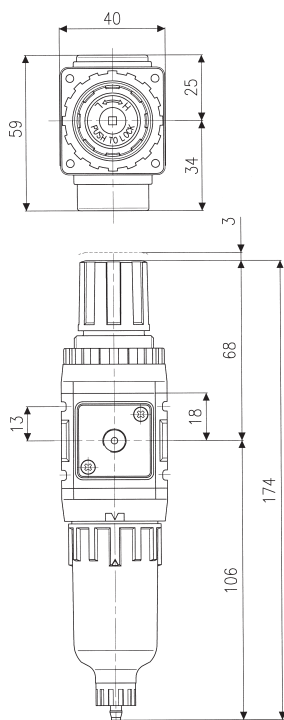

HZ1B ...
HZ2B ...

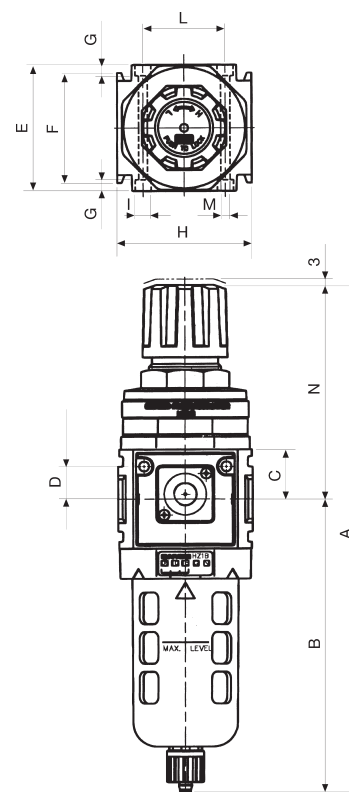

For correct use,
pressure must always
be adjusted upwards.

The correct assembly
sequence is
FR + L.

The L - bracket has two
pins which prevent the
FR from rotating.

Before servicing,
depressurize
the system.

Overall dimensions

	Size 1	Size 2
A	256	287,5
B	148	172
C	25	25
D	16,5	19
E	63	80
F	55	72
G	5,5	5,5
H	67	83
I	8	8
L	41	57
M	$\text{Ø} 4,5$	$\text{Ø} 4,5$
N	108	115,5

The codes do not include the pressure gauges which must be ordered separately. See page 26.



Flow rate characteristics

HZ0B ... Size 1

G 1/4

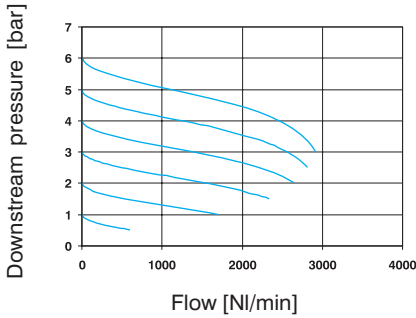

HZ1B ... Size 1

G 1/4

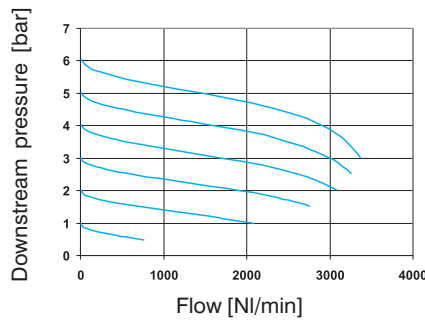

HZ2B ... Size 2

G 3/8

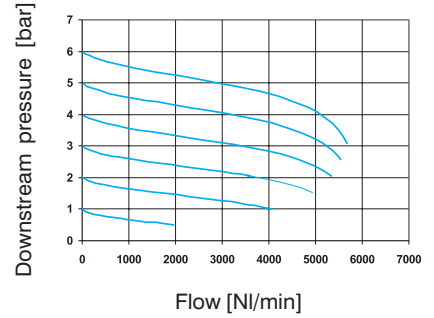

G 3/8

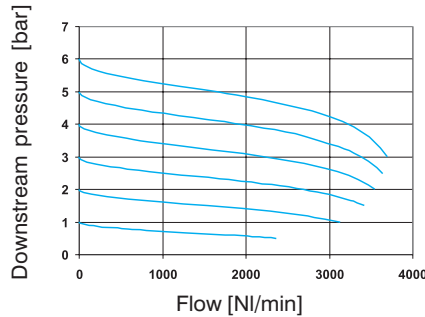

G 1/2

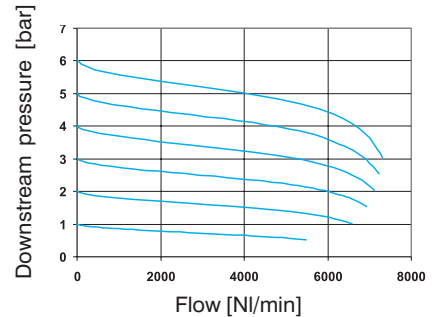

The flow rate characteristics are obtained as follows:

- 1) constant supply pressure (7 bar)
- 2) for each pressure setting (1 - 6 bar) the pressure reducer should be correspondingly set at zero pressure.
- 3) without adjusting the regulator, flow is progressively increased whilst checking downstream pressure.

G 1/2

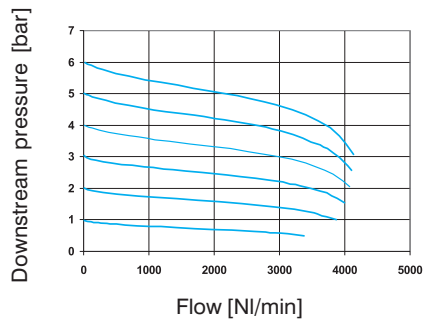

G 3/4

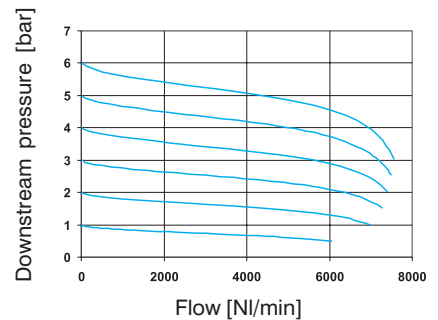

Pressure characteristics

The curve shows the trend of the pressure adjusted to the changing pressure supply.

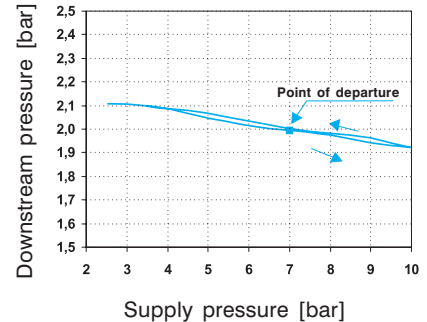
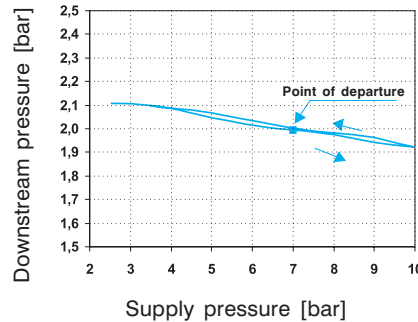
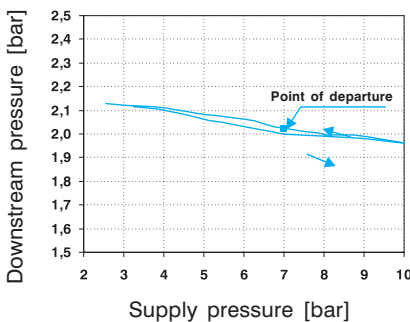

Special features of the UNIVER Regulator: • downstream pressure is kept constant even when upstream pressure varies • quick and responsive regulator servicing • fast elimination of downstream excess pressure.

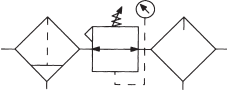

Technical characteristics

	HZ0D ... Size 0	HZ1D ... Size 1	HZ2D ... Size 2
Threaded port	G 1/4	G 1/4 - G 3/8 - G 1/2	G 3/8 - G 1/2 - G 3/4
Filtration rating μm	20 (upon request: 5-50)	5 (upon request: 20-50)	
Flow rate NI/min (7 bar inlet pressure, 6 bar outlet pressure - Δp 1 bar)	931	G 1/4 - 1010	G 3/8 - 1910
		G 3/8 - 1330	G 1/2 - 2320
		G 1/2 - 1680	G 3/4 - 2420
Max. inlet pressure bar - MPa - psi	10 - 1 - 145		
Pressure adjustment by relieving bar	0,5 ÷ 8,5 (upon request: 0,5 ÷ 1,7 - 0,5 ÷ 3,5)		
Fluid	compressed air		
Min/max. temperature $^{\circ}\text{C}$	5 ÷ 60		
Condensation drain capacity cm^3	12	40	70
Condensation drain	manual (upon request: automatic)		
Weight in kg	0,25	1,16	1,85
Foreseen for wall bracket mounting with screws	M3x40	M4 x 60	M4 x 70
Mounting position	vertical		
Recommended oil	ISO VG 32		
Minimum working flow l/min.	25	30	65
Pressure gauge port	G 1/8	G 1/4	G 1/4

Accessories and spare parts on pages 24 and 25.

HZ0D ...

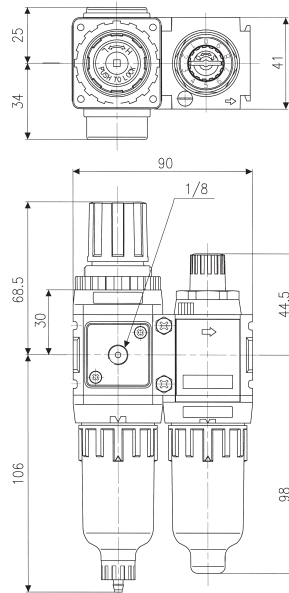

For correct use, pressure must always be adjusted upwards.

Before servicing, depressurize the system.

HZ1D ...
HZ2D ...

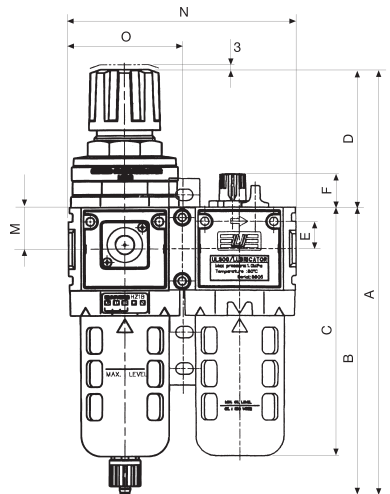

Overall dimensions

	Size 1	Size 2
A	256	287,5
B	173	197
C	150	174
D	83	91
E	16,5	19
F	20,5	21,5
G	10	10
H	105	105
I	83	83
L	32,5	32,5
M	25	25
N	134	166
O	67	83

The codes do not include the pressure gauges which must be ordered separately. See page 26.



Flow rate characteristics

HZ0D ... Size 1

G 1/4

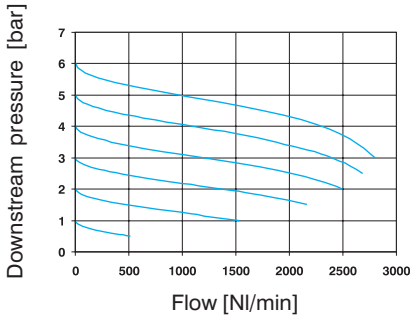

HZ1D ... Size 1

G 1/4

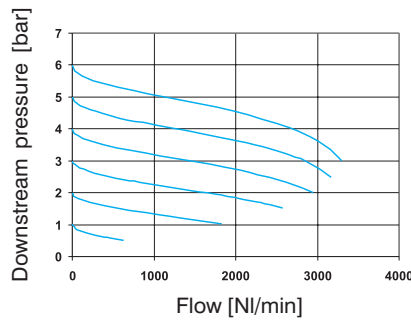

HZ2D ... Size 2

G 3/8

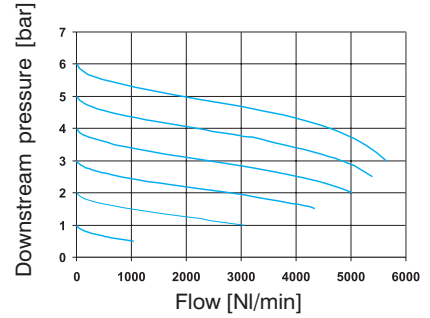

G 3/8

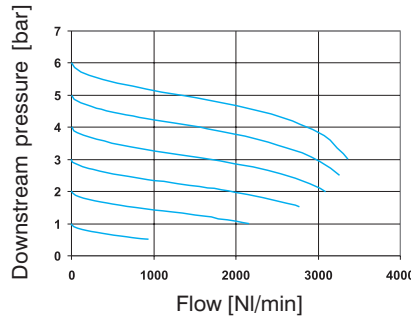

G 1/2

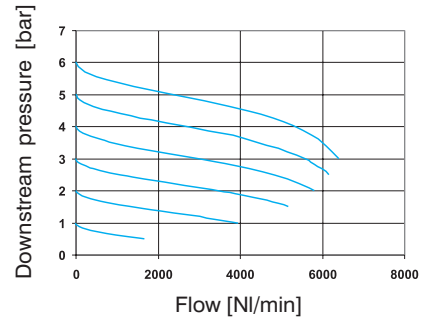

G 1/2

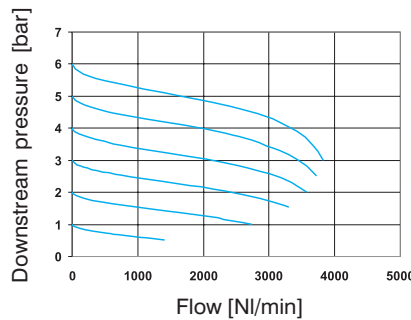

G 3/4

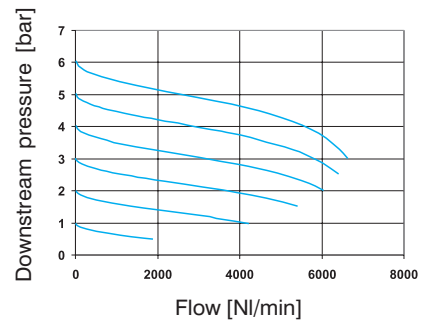

The flow rate characteristics are obtained as follows:

- 1) constant supply pressure (7 bar)
- 2) for each pressure setting (1 - 6 bar) the pressure reducer should be correspondingly set at zero pressure.
- 3) without adjusting the regulator, flow is progressively increased whilst checking downstream pressure.

Pressure characteristics

The curve shows the trend of the pressure adjusted to the changing pressure supply.

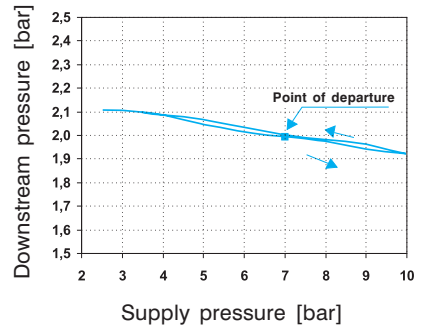
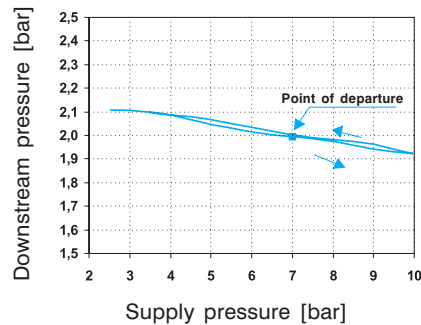
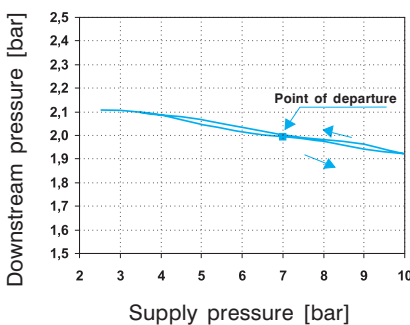

Special features of the UNIVER Regulator: • downstream pressure is kept constant even when upstream pressure varies • quick and responsive regulator servicing • fast elimination of downstream excess pressure.

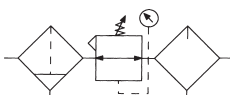

Technical characteristics

	HZ0C ... Size 0	HZ1C ... Size 1	HZ2C ... Size 2
Threaded port	G 1/4	G 1/4 - G 3/8 - G 1/2	G 3/8 - G 1/2 - G 3/4
Filtration rating μm	20 (upon request: 5-50)	5 (upon request: 20-50)	
Flow rate NI/min (7 bar inlet pressure, 6 bar outlet pressure - Δp 1 bar)	920	G 1/4 - 960 G 3/8 - 1230 G 1/2 - 1450	G 3/8 - 1870 G 1/2 - 2070 G 3/4 - 2120
Max. inlet pressure bar - MPa - psi	10 - 1 - 145		
Pressure adjustment by relieving barr	0,5 ÷ 8,5 (upon request: 0,5 ÷ 1,7 - 0,5 ÷ 3,5)		
Fluid	compressed air		
Min/max. temperature $^{\circ}\text{C}$	5 ÷ 60		
Condensation drain capacity cm^3	12	40	70
Condensation drain	manual	manuale (upon request: automatic)	
Weight in kg	0,35	1,50	2,33
Foreseen for wall bracket mounting with screws	M3x40	M4 x 60	M4 x 70
Mounting position	vertical		
Recommended oil	ISO VG 32		
Minimum working flow l/min.	25	30	65
Pressure gauge port	G 1/8	G 1/4	

Accessories and spare parts on pages 24 and 25.

HZ0C ...



HZ1C ...
HZ2C ...



Recommended oil:
ISO VG 32, at the
rate of one drop per
300-600 NI.

Before servicing,
depressurize
the system.

For correct use,
pressure must always
be adjusted upwards.

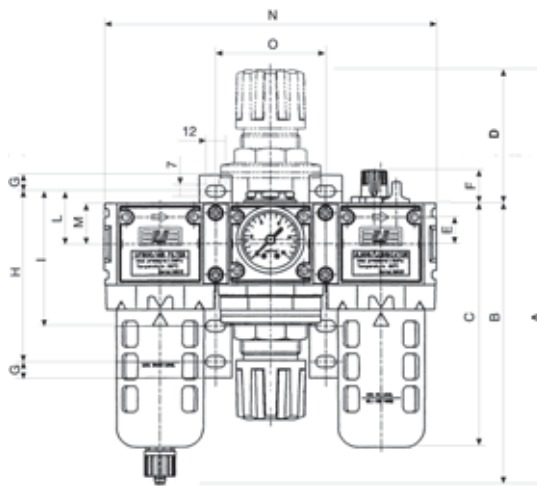
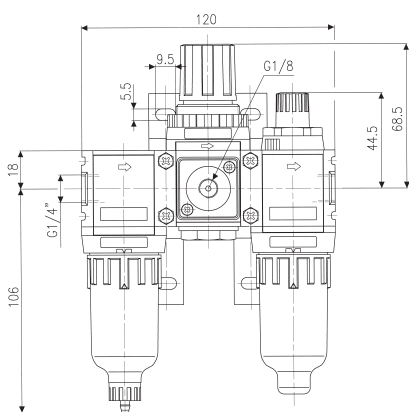
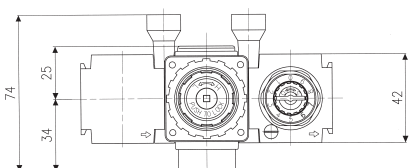

Overall dimensions

	Size 1	Size 2
A	256	287,5
B	173	197
C	150	174
D	83	91
E	16,5	19
F	20,5	21,5
G	10	10
H	105	105
I	83	83
L	32,5	32,5
M	25	25
N	201	249
O	67	83

The codes do not include the pressure gauges which must be ordered separately. See page 26.



Flow rate characteristics

HZ0C ... Size 1

G 1/4

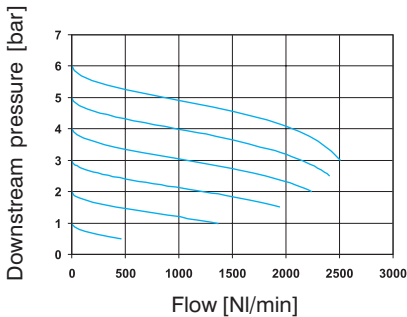

HZ1C ... Size 1

G 1/4

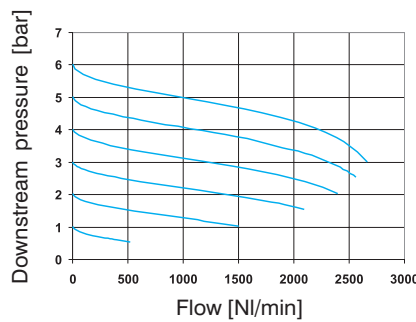

HZ2C ... Size 2

G 3/8

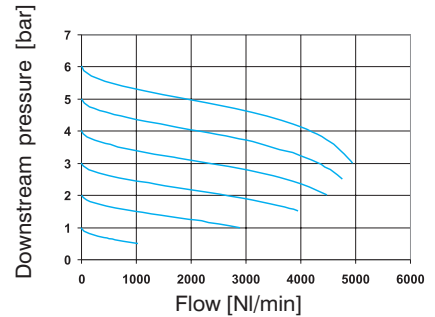

G 3/8

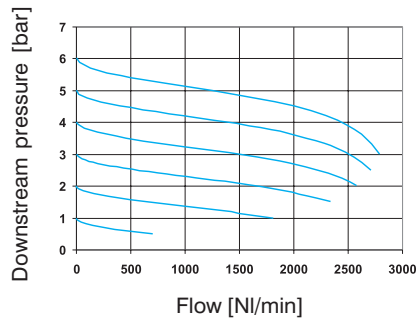

G 1/2

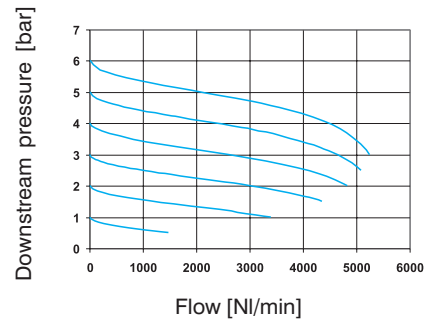

G 1/2

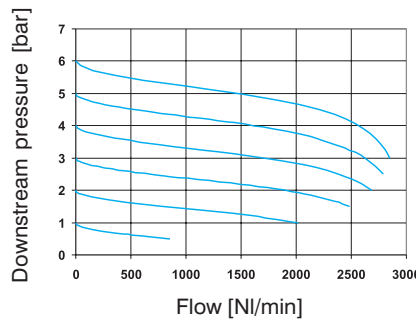

G 3/4

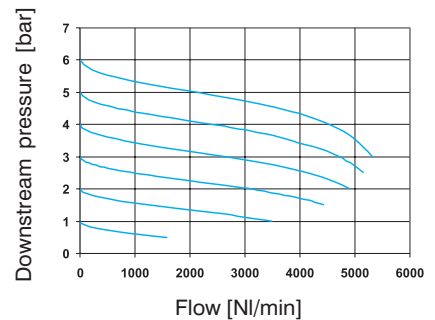

The flow rate characteristics are obtained as follows:

- 1) constant supply pressure (7 bar)
- 2) for each pressure setting (1 - 6 bar) the pressure reducer should be correspondingly set at zero pressure.
- 3) without adjusting the regulator, flow is progressively increased whilst checking downstream pressure.

Pressure characteristics

The curve shows the trend of the pressure adjusted to the changing pressure supply.

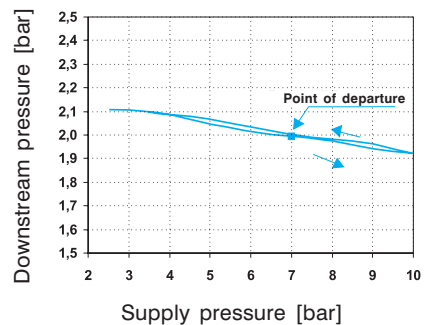
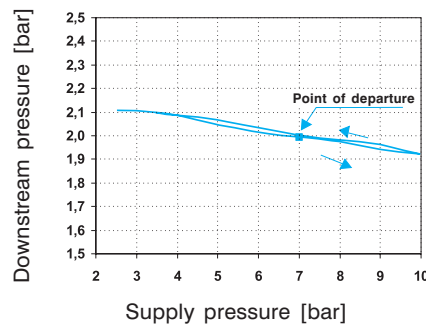
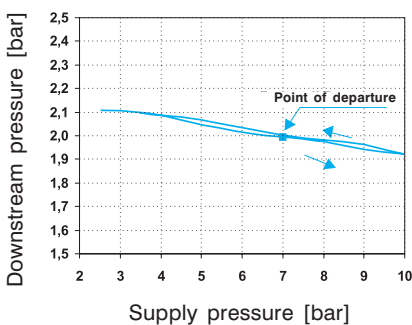

Special features of the UNIVER Regulator: • downstream pressure is kept constant even when upstream pressure varies • quick and responsive regulator servicing • fast elimination of downstream excess pressure.



Assembly kit with central coupling

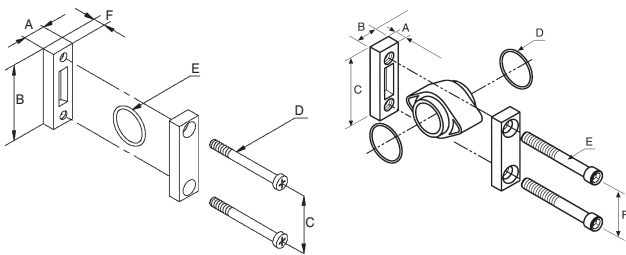

HZ02200 Size 0

A	B	C	D	E	F
9,5	36	26	M3x37	Ø18	5

HZ12200 Size 1

A	B	C	D	E	F
7,8	14,4	49,5	Ø 21	M5x57	38

HZ22200 Size 2

A	B	C	D	E	F
7,8	14,4	49,5	Ø 25	M5x74	38

T bracket with central coupling

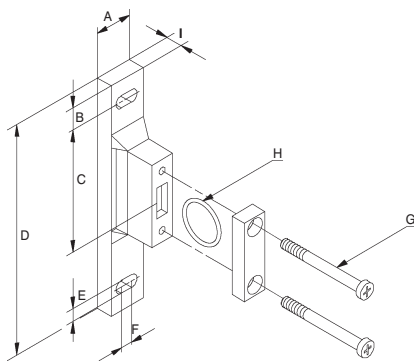

HZ02210 Size 0

A	B	C	D	E	F	G	H	I
16	10	35,5	105	5,5	4	M3x37	Ø 18	7

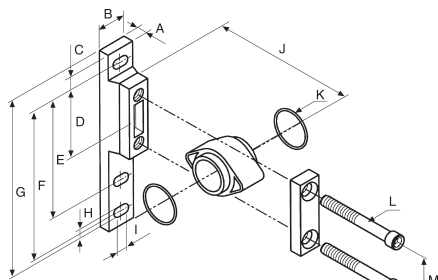

HZ12210 Size 1

A	B	C	D	E	F	G	H	I	J	K	L	M
7	20	10	32,5	83	105	125	7	5	45	Ø 21	M5x57	38

HZ22210 Size 2

A	B	C	D	E	F	G	H	I	J	K	L	M
7	20	10	32,5	83	105	125	7	5	53,5	Ø 25	M5x74	38

Connecting end block (two pieces)

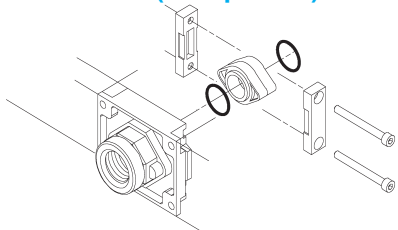

HZ12500 Size 1 G 1/2

G	H	I	L
16	63	50	34

HZ22500 Size 2 G 3/4

G	H	I	L
19	80	50	45,5

Wall bracket

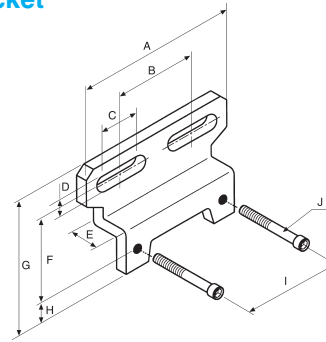

HZ12300 Size 1

A	B	C	D	E	F	G	H	I	J
67,5	34,5	16,5	7	13,5	30	46,5	8	41	M4x62

HZ22300 Size 2

A	B	C	D	E	F	G	H	I	J
83,5	50,5	16,5	7	13,5	30	46,5	8	57	M4x80

Regulator L bracket

The bracket is blocked by the sleeve. Two opposite pins do not allow the regulator to rotate on the axis

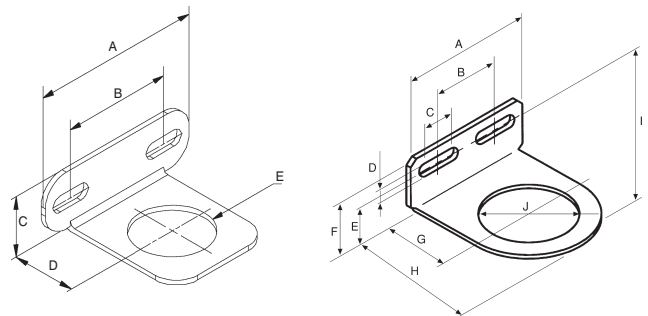

HZ02310 Size 0

A	B	C	D	E
68	44	25	40	Ø 30

HZ12310 Size 1

A	B	C	D	E	F	G	H	I	J
67,5	34,5	16,5	7	18	26	45	76	62	Ø40

HZ22310 Size 2

A	B	C	D	E	F	G	H	I	J
84	55	14	7	18	26	55	94,5	62	Ø47

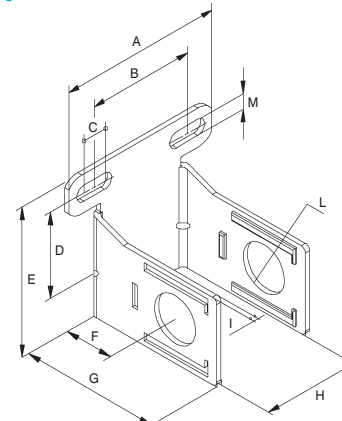

"C" bracket



HZ02300 Size 0

A	B	C	D	E	F	G	H	I	L	M
68	44	9,9	35	61,5	40	60	40	2	19,5	6,6

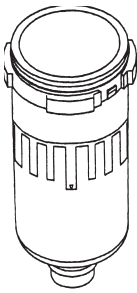
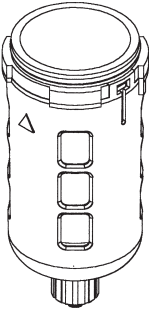
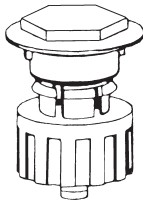
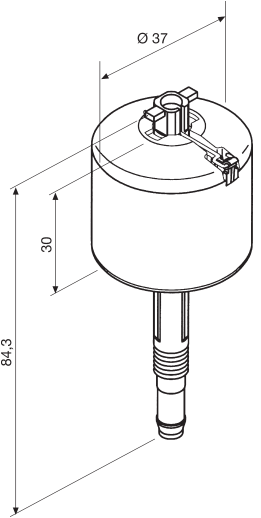
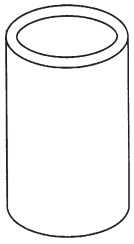
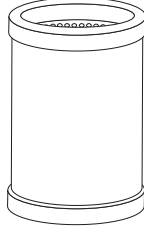
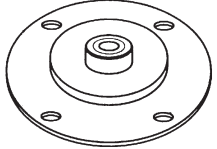
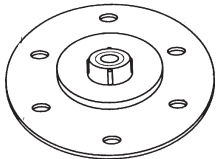

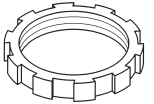
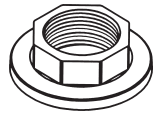
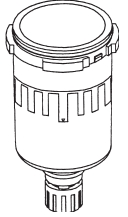
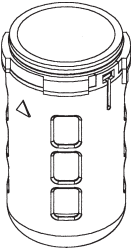
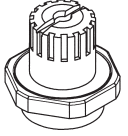
Filter spare parts		
<p>Bowl with guard</p> <p>Size 0 HZ0Z600</p>  <p>Size 1 HZ1Z600</p>  <p>Size 2 HZ2Z600</p>	<p>Manual drain</p> <p>HZ0Z402 Size 0</p> <p>HZ1Z402 Size 1 e 2</p> 	<p>Automatic drain</p> <p>HZ7Z400 Size 1 e 2</p>  <p>To replace: Unscrew the ring nut completely to free the drain lip and push up to remove the unit. Replace and re-lock into place.</p>
<p>Filter elements</p> <p>Size 0</p> <p>5 µm HZ0Z660</p> <p>20 µm HZ0Z662</p> <p>50 µm HZ0Z665</p> <p>Size 1</p> <p>5 µm HZ1Z660</p> <p>20 µm HZ1Z662</p> <p>50 µm HZ1Z665</p> <p>Size 2</p> <p>5 µm HZ2Z660</p> <p>20 µm HZ2Z662</p> <p>50 µm HZ2Z665</p> 	<p>Coalescing filter</p>  <p>0,3 µm Size 1 HZ1Z670</p> <p>Size 2 HZ2Z670</p>	
Regulator spare parts		
<p>Diaphragm assembly</p> <p>Size 0</p> <p>HZ0Z610 with relieving</p> <p>HZ0Z611 without relieving</p> <p>Size 1</p> <p>HZ1Z610 with relieving</p> <p>HZ1Z611 without relieving</p> <p>Size 2</p> <p>HZ2Z610 with relieving</p> <p>HZ2Z611 without relieving</p>  	<p>Regulator spring</p> <p>Pressure regulation</p> <p>Size 1</p> <p>0,5 ÷ 1,7 HZ1Z652</p> <p>0,5 ÷ 3,5 HZ1Z654</p> <p>0,5 ÷ 8,5 HZ1Z658</p> <p>Pressure regulation</p> <p>Size 2</p> <p>0,5 ÷ 1,7 HZ2Z652</p> <p>0,5 ÷ 3,5 HZ2Z654</p> <p>0,5 ÷ 8,5 HZ2Z658</p> 	<p>Panel ring nut</p> <p>Size 0 HZ0Z603</p>  <p>Size 1 HZ1Z603</p>  <p>Size 2 HZ2Z603</p>
Lubricator spare parts		
<p>Bowl with guard</p> <p>Size 0 HZ0Z601</p>  <p>Size 1 HZ1Z601</p>  <p>Size 2 HZ2Z601</p>	<p>Lubricator dome</p> <p>Size 0-1-2 HZ7Z470</p> 	



HZ9P ...Pressure gauge



Part number	Ø	bar scale / MPa	Port
HZ9P400318	40	0 - 2,5 / 0 - 0,25	G1/8C
HZ9P400618		0 - 6 / 0 - 0,6	
HZ9P401018		0 - 10 / 0 - 1	
HZ9P500314	50	0 - 2,5 / 0 - 0,25	G1/4C
HZ9P500614		0 - 6 / 0 - 0,6	
HZ9P501014		0 - 10 / 0 - 1	
HZ9P630314	63	0 - 2,5 / 0 - 0,25	G1/4C
HZ9P630614		0 - 6 / 0 - 0,6	
HZ9P631014		0 - 10 / 0 - 1	

PORT - BOURDON PIPE: Brass / Copper alloy
BODY: Black ABS plastics
MOVEMENT: Brass
INDICATOR: Aluminium painted black
DIAL: Pressure inserted acrylic. Polycarbonate on request.
ACCURACY: EN 837 class 1,6 - 2,5. ASME B40.1 Grade B
PROTECTION: IP 43

HZ9PB ... Pressure gauge with flange for panel mounting



Part number	Ø	bar scale / MPa	Port
HZ9PB400318	40	0 - 2,5 / 0 - 0,25	G1/8C
HZ9PB400618		0 - 6 / 0 - 0,6	
HZ9PB401018		0 - 10 / 0 - 1	
HZ9PB500314	50	0 - 2,5 / 0 - 0,25	G1/4C
HZ9PB500614		0 - 6 / 0 - 0,6	
HZ9PB501014		0 - 10 / 0 - 1	
HZ9PB630314	63	0 - 2,5 / 0 - 0,25	G1/4C
HZ9PB630614		0 - 6 / 0 - 0,6	
HZ9PB631014		0 - 10 / 0 - 1	

PORT - BOURDON PIPE: Brass / Copper alloy
BODY: Metal painted black
ASSEMBLY: Chrome-plated front flange with three holes
MOVEMENT: Brass
INDICATOR: Aluminium painted black
DIAL: Acrylic. Polycarbonate on request.
ACCURACY: EN 837 class 1,6 - 2,5. ASME B40.1 Grade B
PROTECTION: IP 43

HZ9PBS ... Pressure gauge with bracket for panel mounting



Part number	Ø	bar scale / MPa	Port
HZ9PBS400318	40	0 - 2,5 / 0 - 0,25	G1/8C
HZ9PBS400618		0 - 6 / 0 - 0,6	
HZ9PBS401018		0 - 10 / 0 - 1	
HZ9PBS500314	50	0 - 2,5 / 0 - 0,25	G1/4C
HZ9PBS500614		0 - 6 / 0 - 0,6	
HZ9PBS501014		0 - 10 / 0 - 1	
HZ9PBS630314	63	0 - 2,5 / 0 - 0,25	G1/4C
HZ9PBS630614		0 - 6 / 0 - 0,6	
HZ9PBS631014		0 - 10 / 0 - 1	

PORT - BOURDON PIPE: Brass / Copper alloy
BODY: Metal painted black
ASSEMBLY: Fixed with back bracketed
MOVEMENT: Brass
INDICATOR: Aluminium painted black
DIAL: Acrylic. Polycarbonate on request.
ACCURACY: EN 837 class 1,6 - 2,5. ASME B40.1 Grade B
PROTECTION: IP 43

HZ9464 Built-in pressure gauge for Sizes 0 - 1 - 2 (0 - 10 bar)



For other types of pressure gauges please contact our sales office.