

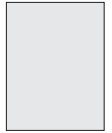

TIRISTORI I TRIJACI

Tir



TIRISTORI
TRIJACI
PREGLED ZAMENA





TIRISTORI I TRIJACI

TIR

TIRISTORI TIR

TIRISTORI 0,6 - 50A

Tip	Cena	U_{DRM} U_{RRM} (V)	I_{TAV} (A)	I_{GT} (mA)	Case
BR101	1,80	30	0,6	0,2	X55
BR103	2,00	30	0,6	0,2	X55
BR203	3,50	30	0,6	0,2	TO39
BR303	5,00	30	0,6	0,2	TO126
TR303	5,00	30	0,6	0,2	TO39
BRX44	1,40	30	0,5	0,2	X55
BRX45	1,40	60	0,5	0,2	X55
BRX46	1,40	100	0,5	0,2	X55
BRX47	1,40	200	0,5	0,2	X55
BRX48	1,40	300	0,5	0,2	X55
BRX49	1,40	400	0,5	0,2	X55
BRY39	6,00	70	0,25	0,2	X55
BRY55	2,00	400	0,4	0,2	X55
BRY55	2,50	600	0,4	0,2	X55
BT151	2,00	800	12	20	TO220B
BT152	3,00	800	20	20	TO220B
BT911	7,00	500	3,2	40	TO66
BT912	7,00	500	3,2	40	TO66
BTW69	18,00	1200	50	50	TOP3A

U_{DRM} - probojni napon neprovdnog stanja
 U_{RRM} - probojna vrednost reverznog napona
 I_{TAV} - poprečna struja provodjenja, I_{GT} -struja okidanja gejta

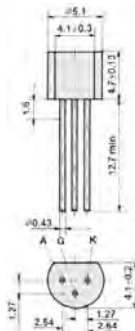

X55

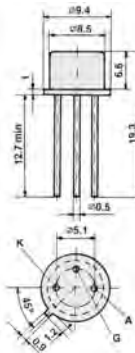

TO39

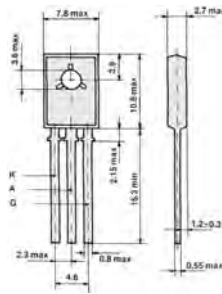

TO126

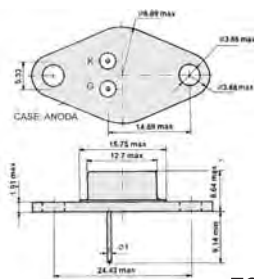

TO66

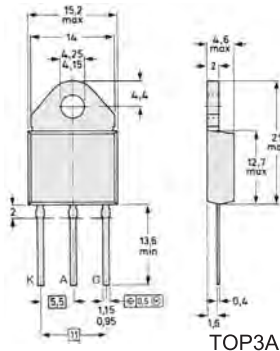

TOP3A





TIRISTORI I TRIJACI

TIR

TIRISTORI TIR SNAZNI TIRISTORI

Tip	Cena	U_{DRM} U_{RRM} (V)	I_{TAV} (A)	I_{TSM} (KA)	I_{DRM} (mA)	Case
T00-50/M8	36,00	600	50	1,5	10	T00-50/M8
T00-50/M20	48,00	900	50	1,5	10	T00-50/M20
T00-80	58,00	600	80	2,0	10	T00-80
T00-100	78,00	900	100	2,5	10	T00-100

U_{DRM} - probojni napon neprovodnog stanja, U_{RRM} - probojna vrednost reverznog napona, I_{TAV} - poprečna struja provođenja, I_{TSM} - udarna struja provođenja, I_{DRM} - probojna struja neprovodnog stanja pri U_{DRM}

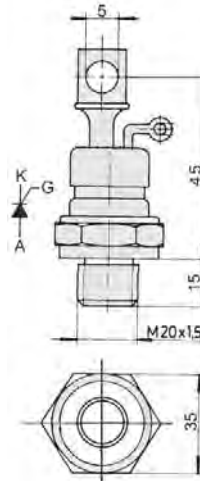

T00-50/M20

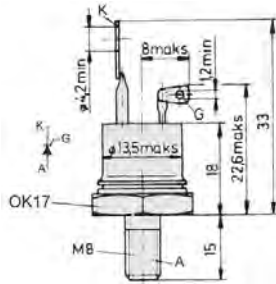

T00-50/M8

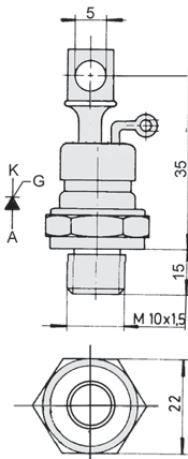

T00-80

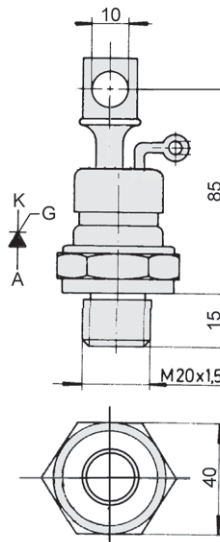

T00-100



TIRISTORI I TRIJACI

TIR

TIRISTORI TIR

SNAZNI TIRISTORI

Tip	Cena	U_{DRM} U_{RRM} (V)	I_{TAV} (A)	I_{TSM} (KA)	I_{DRM} (mA)	Case
T00-135	156,00	1300	135	3,6	15	T00-135
T00-250	186,00	900	250	6,3	15	T00-250
T20-250	196,00	900	250	4,5	15	P-30

U_{DRM} - probojni napon neprovođnog stanja, U_{RRM} - probojna vrednost reverznog napona, I_{TAV} - poprečna struja provođenja, I_{TSM} - udarna struja provođenja, I_{DRM} - probojna struja neprovođnog stanja pri U_{DRM}

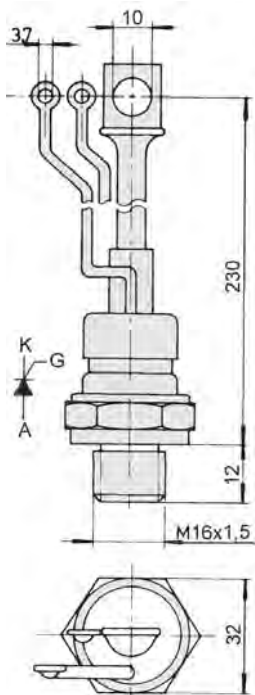

T00-135

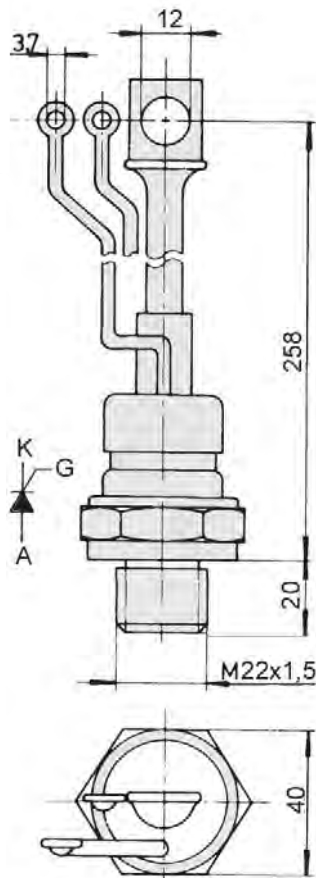

T00-250



P30

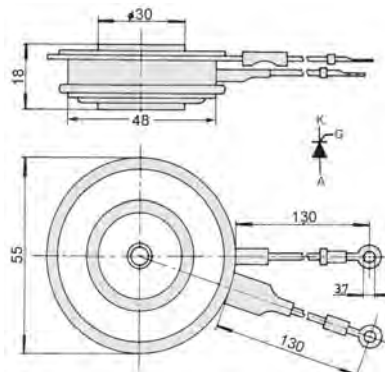



TIRISTORI I TRIJACI

TIR

TIRISTORI TIR

TIRISTORSKI MODULI

Tip	Cena	U_{DRM} U_{PRM} (V)	I_{TAV} (A)	I_{TSM} (KA)	I_{GT} (mA)	U_{GT} (V)	Case
MTT25	85,00	600	25	0,9	150	3	TO240
SKKT26	96,00	600	26	0,9	150	3	TO240
SKKT56	136,00	800	56	1,35	150	3	TO240
MCC44-12I01B	158,00	1200	80	1,8	150	3	TO240
MCC56-12I08B	176,00	1200	100	3,2	150	3	TO240
MCC95-08I08B	228,00	800	180	6,0	150	3	TO240

U_{DRM} - probojni napon neprovođenog stanja, U_{RRM} - probojna vrednost reverznog napona, I_{TAV} - poprečna struja provođenja, I_{TSM} - udarna struja provođenja, I_{GT} - struja okidanja gejta, U_{GT} - napon okidanja gejta

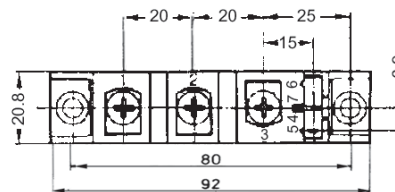
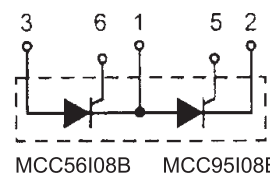
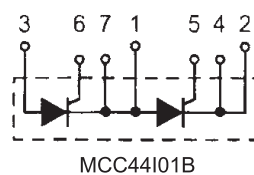
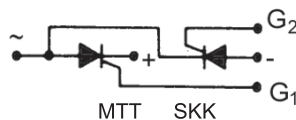
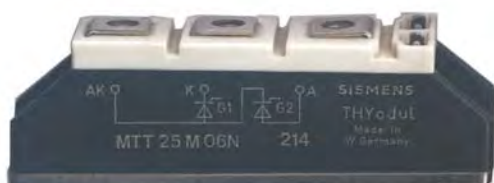

TITRISTORSKO-DIODNI MODUL

Tip	Cena	U_{DRM} U_{PRM} (V)	I_{TAV} (A)	I_{TSM} (KA)	I_{GT} (mA)	U_{GT} (V)	Case
MCD26-08I08B	98,00	800	50	1,35	150	3	TO240

U_{DRM} - probojni napon neprovođenog stanja, U_{RRM} - probojna vrednost reverznog napona, I_{TAV} - poprečna struja provođenja, I_{TSM} - udarna struja provođenja, I_{GT} - struja okidanja gejta, U_{GT} - napon okidanja gejta

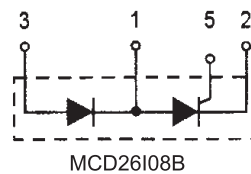
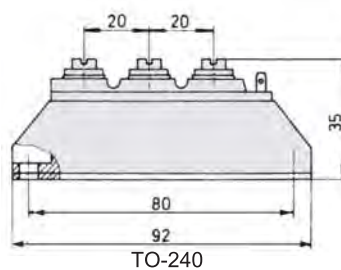



TIRISTORI I TRIJACI

TIR

TRIJACI. TIR

Tip	Cena	U_{DRM} U_{RRM} (V)	I_{TAV} (A)	I_{GT} (mA)	Case
BT136	1,20	600	4	20	TO220C
BT137	1,50	600	8	20	TO220C
BT138	1,80	600	12	30	TO220C
BT139	2,00	600	16	30	TO220C
BTA04	2,50	600	4	25	TO220C
BTA06	2,80	600	6	25	TO220C
BTA08	3,00	600	8	50	TO220C
BTA10	3,20	600	10	50	TO220C
BTA12	3,50	600	12	50	TO220C
BTA16	4,00	600	16	50	TO220C
BTA26	9,00	600	25	75	TOP3B
BTA41	14,00	600	40	80	TOP3B
KT207	3,00	400	5	35	TO220D
KT728	12,00	400	15	100	TO-48
TC112	12,00	1000	16	80	TO-40
TC122	18,00	1000	25	40	TO-48
TIC201M	2,00	600	2,5	<20	TO220C
TIC206M	2,20	600	4	<20	TO220C
TIC216M	2,50	600	6	<20	TO220C
TIC225M	2,50	600	8	<15	TO220C
TIC226M	2,50	600	8	30	TO220C
TIC226N	3,00	800	8	30	TO220C
TIC236M	3,50	600	12	40	TO220C
TIC236N	4,00	800	12	40	TO220C
TIC246M	4,00	600	16	40	TO220C
TIC246N	4,50	800	16	40	TO220C
TIC253M	9,00	600	20	50	TOP3B
TIC253N	10,00	800	20	50	TOP3B
TIC263M	12,00	600	25	50	TOP3B
TIC263N	14,00	800	25	50	TOP3B

U_{DRM} - probojni napon neprovodnog stanja, U_{RRM} - probojna vrednost reverznog napona, I_{TAV} - poprečna struja provođenja, I_{GT} -struja okidanja gejta

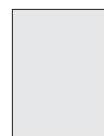
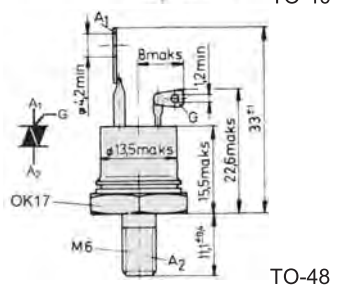
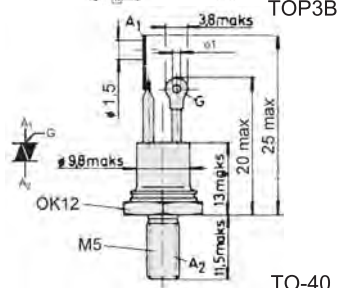
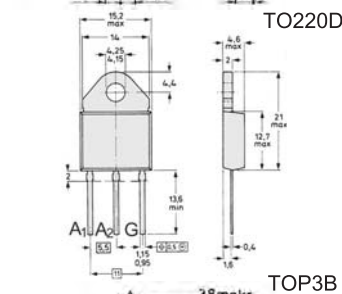
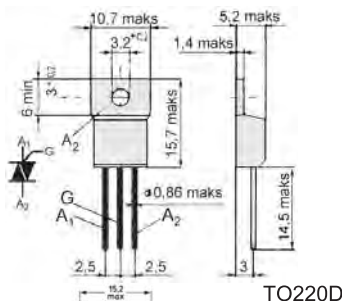
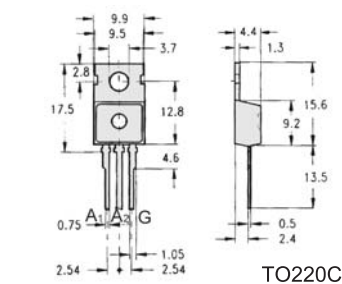



TIRISTORI I TRIJACI

TIR

PREGLED ZAMENA

TIRISTORI I TRIJACI

BRX45	→	TIC45	BT137/500	→	TIC226E	MAC220-2	→	TIC226A
BRX46	→	TIC46	BT137/600	→	TIC226M	MAC220-3	→	TIC226A
BRX47	→	TIC47	BT138/500	→	TIC236E	MAC220-5	→	TIC226C
BS7-02A	→	TIC216B	BT138/600	→	TIC236M	MAC220-7	→	TIC226E
BS7-04A	→	TIC216D	BT139/500	→	TIC246E	MAC220-9	→	TIC226S
BS7-05A	→	TIC216E	BT139/600	→	TIC246M	MAC221-2	→	TIC226A
BS9-02A	→	TIC226B	BT151/650	→	TIC116S	MAC221-3	→	TIC226A
BS9-04A	→	TIC226D	BT162-400	→	TIC236D	MAC221-5	→	TIC226C
BS9-05A	→	TIC226E	BT162-600	→	TIC236M	MAC221-7	→	TIC226E
BSTB0106	→	TIC106A	CS0.6-02G0	→	TIC106B	MAC221-9	→	TIC226S
BSTB0113	→	TIC106B	CS0.6-04G0	→	TIC106D	MCR106-1	→	TIC106A
BSTB0126	→	TIC106D	CS0.6-06G0	→	TIC106M	MCR106-2	→	TIC106A
BSTB0133	→	TIC106E	CS0.6-08G0	→	TIC106N	MCR106-3	→	TIC106A
BSTB0140	→	TIC106M	CS1-02G0	→	TIC116B	MCR106-4	→	TIC106B
BSTB0146	→	TIC106S	CS1-04G0	→	TIC116D	MCR106-5	→	TIC106C
BSTB0206	→	TIC108A	CS1-06G0	→	TIC116M	MCR106-6	→	TIC106D
BSTB0213	→	TIC108B	CS3-02D0	→	TIC116B	MCR106-7	→	TIC106E
BSTB0226	→	TIC108D	CS3-04D0	→	TIC116D	MCR106-8	→	TIC106M
BSTB0233	→	TIC108E	CS3-05D0	→	TIC116E	MCR106-9	→	TIC106S
BSTB0240	→	TIC108M	CS3-06D0	→	TIC116M	MCR106-10	→	TIC106N
BSTB0246	→	TIC108S	CS3-07D0	→	TIC116S	MCR107-1	→	TIC108A
BSTC0206	→	TIC108A	CS3.5-02D0	→	TIC126B	MCR107-2	→	TIC108A
BSTC0213	→	TIC108B	CS3.5-0.4D0	→	TIC126D	MCR107-3	→	TIC108A
BSTC0226	→	TIC108D	CS3,5-0.6D0	→	TIC126M	MCR107-4	→	TIC108B
BSTC0233	→	TIC108E	CS3.5-0.7D0	→	TIC126S	MCR107-5	→	TIC108C
BSTC0240	→	TIC108M	C106	→	TIC106	MCR107-6	→	TIC108D
BSTC0246	→	TIC108S	C106	→	S106	MCR107-7	→	TIC108E
BSTC0706	→	TIC108A	C107	→	TIC106	MCR107-8	→	TIC108M
BSTC0713	→	TIC108B	C108	→	TIC106	MCR107-9	→	TIC108S
BSTC0726	→	TIC108D	MAC10-1	→	TIC236A	MCR107-10	→	TIC108N
BSTC0733	→	TIC108E	MAC10-2	→	TIC236A	MCR220-5	→	TIC126C
BSTC0740	→	TIC108M	MAC10-3	→	TIC236A	MCR220-7	→	TIC126E
BSTC0746	→	TIC108S	MAC10-4	→	TIC236B	MCR220-9	→	TIC126S
BSTC1026	→	TIC108D	MAC10-5	→	TIC236C	MCR221-5	→	TIC126C
BSTC1033	→	TIC108E	MAC10-6	→	TIC236C	MCR221-7	→	TIC126E
BSTC1040	→	TIC108M	MAC10-7	→	TIC236D	MCR221-9	→	TIC126S
BSTC1046	→	TIC108S	MAC10-8	→	TIC236E	S106	→	TIC106
BSTC1053	→	TIC108N	MAC11-1	→	TIC236M	S106	→	C106
BSTD1026	→	TIC116D	MAC11-2	→	TIC236A	S107	→	TIC106
BSTD1033	→	TIC116E	MAC11-3	→	TIC236A	S108	→	TIC108
BSTD1040	→	TIC116M	MAC11-4	→	TIC236A	S122	→	TIC126
BSTD1046	→	TIC116S	MAC11-5	→	TIC236B	S2060	→	TIC106
BSTD1053	→	TIC116N	MAC11-6	→	TIC236C	S2061	→	TIC106
BSTD1026M	→	TIC126D	MAC11-7	→	TIC236D	S2062	→	TIC108
BSTD1033M	→	TIC126E	MAC15-4	→	TIC236E	S2600	→	TIC116
BSTD1040M	→	TIC126M	MAC15-6	→	TIC246B	S2800	→	TIC116
			MAC15-8	→	TIC246D	S6000	→	TIC116
				→	TIC246M			TIC126



TIRISTORI I TRIJACI

TIR

PREGLED ZAMENA

TIRISTORI

BBC106	→	TIC106N	BStC0733	→	TIC106M	BT108	→	T112
BR403	→	BR303	BStC0740	→	TIC106M	BT109	→	T112
BRX50	→	BRX49	BStC0746	→	TIC106N	BT132	→	T112
BRX51	→	BRX49	BStC1026	→	TIC106D	BT133	→	T112
BRX52	→	BRX49	BStC1033	→	TIC106M	BT146	→	BT152
BRX53	→	BRX49	BStC1040	→	TIC106N	BT148	→	BT152
BRX54	→	BRX49	BStC1046	→	TIC106N	BT151	→	TIC116N
BRX60	→	BR303	BStC1053	→	TIC106N	BTW23	→	T00-135
BRY46	→	BR101	BStC3126	→	TIC106D	BTW24	→	T00-63
BRY71	→	BRY55	BStC3133	→	TIC106M	BTW35	→	T112
BStB0106	→	TIC106D	BStC3140	→	TIC106M	BTW38	→	T112
BStB0113	→	TIC106D	BStC3146	→	TIC106N	BTW42	→	T112
BStB0126	→	TIC106D	BStC3153	→	TIC106N	BTW49	→	T112
BStB0133	→	TIC106M	BStD0220	→	T112	BTX31	→	T112
BStB0140	→	TIC106M	BStD0240	→	T112	BTX32	→	T112
BStB0146	→	TIC106N	BStD0260	→	T112	BTX35	→	T112
BStB0206	→	TIC106D	BStD0313	→	T112	BTX36	→	T112
BStB0213	→	TIC106D	BStD0326	→	T112	BTX37	→	T00-63
BStB0226	→	TIC106D	BStD0340	→	T112	BTX38	→	T00-63
BStB0233	→	TIC106M	BStD0353	→	T112	BTX44	→	T00-63
BStB0240	→	TIC106M	BStD0366	→	T112	BTX45	→	T00-100
BStB0246	→	TIC106N	BStD0380	→	T112	BTX46	→	T00-135
BStC0106	→	T112	BStD1026	→	TIC116M	BTX47	→	T112
BStC0113	→	T112	BStD1026M	→	TIC126M	BTX48	→	T112
BStC0126	→	T112	BStD1033	→	TIC116M	BTX50	→	T00-100
BStC0133	→	T112	BStD1033M	→	TIC126M	BTX70	→	T112
BStC0140	→	T112	BStD1040	→	TIC116M	BTX71	→	T112
BStC0146	→	T112	BStD1040M	→	TIC126M	BTX72	→	T112
BStC0206	→	TIC106D	BStD1046	→	TIC116N	BTX73	→	T112
BStC0213	→	TIC106D	BStD1046M	→	TIC126N	BTX74	→	T112
BStC0226	→	TIC106D	BStD1053	→	TIC106N	BTX75	→	T112
BStC0233	→	TIC106M	BStD1053M	→	TIC126N	BTX76	→	T112
BStC0240	→	TIC106M	BStD4126	→	T112	BTX92	→	T112
BStC0246	→	TIC106N	BStD4126M	→	T112	BTY28	→	T112
BStC0313	→	T112	BStD4133	→	T112	BTY29	→	T112
BStC0326	→	T112	BStD4133M	→	T112	BTY30	→	T112
BStC0340	→	T112	BStD4140	→	T112	BTY31	→	T112
BStC0353	→	T112	BStD4140M	→	T112	BTY34	→	T112
BStC0366	→	T112	BStD4146	→	T112	BTY35	→	T112
BStC0606	→	BT911	BStD4146M	→	T112	BTY36	→	T112
BStC0613	→	BT911	BStD4153	→	T112	BTY37	→	T112
BStC0626	→	BT911	BStD4153M	→	T112	BTY38	→	T112
BStC0633	→	BT911	BT100	→	TIC106M	BTY39	→	T112
BStC0706	→	TIC106D	BT101	→	KT707	BTY41	→	T112
BStC0713	→	TIC106D	BT102	→	KT707	BTY43	→	T112
BStC0726	→	TIC106D	BT106A	→	TIC106M	BTY44	→	T112
			BT107	→	T112			





TIRISTORI I TRIJACI

TIR

PREGLED ZAMENA

TIRISTORI

BTY46	→ T112	CS1-08G0	→ TIC116N	MCR100-5	→ BRY55
BTY47	→ T112	CS3-02D0	→ TIC116M	MCR100-6	→ BRY55
BTY57	→ T112	CS3-04D0	→ TIC116M	MCR100-7	→ BRY55
BTY58	→ T112	CS3-06D0	→ TIC116M	MCR100-8	→ BRY55
BTY59	→ T112	CS3-07D0	→ TIC116N	MCR101	→ BRY55
BTY60	→ T112	CS3.5-02D0	→ TIC126M	MCR102	→ BRY55
BTY61	→ T112	CS3.5-04D0	→ TIC126M	MCR103	→ BRY55
BTY62	→ T112	CS3.5-06D0	→ TIC126M	MCR104	→ BRY55
BTY72	→ T112	CS3.5-07D0	→ TIC126N	MCR106-1	→ TIC106D
BTY80	→ T112			MCR106-2	→ TIC106D
BTY81	→ T112	CSF0.7-04	→ TIC106N	MCR106-3	→ TIC106D
BTY84	→ T112	CSF02AM1	→ BRX45	MCR106-4	→ TIC106D
BTY85	→ T112	CSF02AM2	→ BRX46	MCR106-5	→ TIC106D
BTY86	→ T112	CSF02AM4	→ BRX47	MCR106-6	→ TIC106D
BTY87	→ T112	CSF02AM8	→ BRX48	MCR106-7	→ TIC106M
BTY88	→ T112	CSF02AM10	→ BRX49	MCR106-8	→ TIC106M
BTY89	→ T112	CSM282	→ TIC106D	MCR106-9	→ TIC106N
BTY90	→ T112	CSM284	→ TIC106D	MCR106-10	→ TIC106N
BTY95	→ T00-63	CSM382	→ TIC106D	MCR107-1	→ TIC106D
BTY96	→ T00-63	CSM384	→ TIC106D	MCR107-2	→ TIC106D
BTY97	→ T00-63	CSM582	→ TIC106M	MCR107-3	→ TIC106D
BTY98	→ T00-63	CSM584	→ TIC106M	MCR107-4	→ TIC106D
BTY99	→ T00-63			MCR107-5	→ TIC106D
BTZ18	→ T112	D65	→ BRY55	MCR107-6	→ TIC106D
BTZ19	→ T112	D66	→ BRY55	MCR107-7	→ TIC106M
BTZ21	→ T112	ESM504...	→ TIC116N	MCR107-8	→ TIC106M
BTZ35	→ T112	ESM508...	→ BT152	MCR107-9	→ TIC106N
BTZ36	→ T112	ESM509...	→ BT152	MCR107-10	→ TIC106N
BTZ37	→ T112	F0810..	→ TIC116N	MCR220-5	→ TIC126M
BTZ38	→ T112	F1612..	→ TIC126N	MCR220-7	→ TIC126M
BTZ39	→ T112			MCR220-9	→ TIC126N
C106A..Y	→ TIC106N	IP100	→ BRX44	MCR221-5	→ TIC126M
C107A..Y	→ TIC106N	IP101	→ BRX46	MCR221-7	→ TIC126M
C108A..Y	→ TIC106N	IP102	→ BRX46	MCR221-9	→ TIC126N
C116A..Y	→ TIC116N	IP103	→ BRX47	MCR406-1	→ TIC106D
C122A..Y	→ TIC116N	IP104	→ BRX47	MCR406-2	→ TIC106D
C203A..Y	→ BRX49	IP105	→ BRX48	MCR406-3	→ TIC106D
C205Y	→ TR303	IP106	→ BRX49	MCR406-4	→ TIC106D
C228A..U	→ T112	KT701	→ KT705	MCR407-1	→ TIC106D
CS0.6-02G0	→ TIC106D	KT704	→ KT705	MCR407-2	→ TIC106D
CS0.6-04G0	→ TIC106D	KT706	→ KT707	MCR407-3	→ TIC106D
CS0.6-06G0	→ TIC106M			MCR407-4	→ TIC106D
CS0.6-08G0	→ TIC106N	MCR67-1	→ T112	MCR729-5	→ T112
CS1-02G0	→ TIC116M	MCR67-2	→ T112	MCR729-6	→ T112
CS1-04G0	→ TIC116M	MCR67-3	→ T112	MCR729-7	→ T112
CS1-06G0	→ TIC116M	MCR100-3	→ BRY55	MCR729-8	→ T112
		MCR100-4	→ BRY55	MCR729-9	→ T112
				MCR729-10	→ T112



TIRISTORI I TRIJACI

TIR

PREGLED ZAMENA

TIRISTORI

MCR846-1	→ T112	RTL0605	→ BT152	S106	→ TIC106M
MCR846-2	→ T112	RTL0610	→ BT152	S107	→ TIC106M
MCR846-3	→ T112	RTL0620	→ BT152	S108	→ TIC106M
MCR846-4	→ T112	RTL0640	→ BT152	S122	→ TIC106M
MCR1308-1	→ T112	RTL0660	→ BT152	S0605	→ TIC106M
MCR1308-2	→ T112	RTL0805	→ BT152	S0607	→ TIC116M
MCR1308-3	→ T112	RTL0810	→ BT152	S0805	→ TIC116M
MCR1308-4	→ T112	RTL0820	→ BT152	S0807	→ TIC116M
MCR1308-5	→ T112	RTL0840	→ BT152	S0810	→ TIC116M
MCR1308-6	→ T112	RTL0860	→ BT152	S1005	→ TIC126M
MCR2315-1	→ T112	RTL1005	→ BT152	S1007	→ TIC126M
MCR2315-2	→ T112	RTL1010	→ BT152	S1010	→ TIC126M
MCR2315-3	→ T112	RTL1020	→ BT152	S1210	→ TIC126M
MCR2315-4	→ T112	RTL1030	→ BT152	S1610	→ BT152
MCR2315-5	→ T112	RTL1040	→ BT152	S1612	→ BT152
MCR2315-6	→ T112	RTL1050	→ BT152	S2012	→ BT152
MCR3000-1	→ TIC126M	RTL1060	→ BT152	S2060	→ TIC106M
MCR3000-2	→ TIC126M			S2061	→ TIC106M
MCR3000-3	→ TIC126M	RTM	→ RTL	S2062	→ TIC106M
MCR3000-4	→ TIC126M	RTN0805	→ T112	S2600	→ TIC116M
MCR3000-5	→ TIC126M	RTN0810	→ T112	S2800	→ TIC116M
MCR3000-6	→ TIC126M	RTN0820	→ T112	S6000	→ TIC126M
MCR3000-7	→ TIC126M	RTN0840	→ T112	S7502	→ BRY55
MCR3000-8	→ TIC126M	RTN0860	→ T112	S7503	→ BRY55
MCR3000-9	→ TIC126N	RTN1005	→ T112	SF0R1B41	→ BRY55
MCR3000-10	→ TIC126N	RTN1010	→ T112	SF0R1D41	→ BRY55
MCR3918-1	→ T112	RTN1020	→ T112	SF0R1G41	→ BRY55
MCR3918-2	→ T112	RTN1030	→ T112	SF0R1B42	→ BRY55
MCR3918-3	→ T112	RTN1040	→ T112	SF0R1D42	→ BRY55
MCR3918-4	→ T112	RTN1050	→ T112	SF0R1G42	→ BRY55
MCR3918-5	→ T112	RTN1060	→ T112		
MCR3918-6	→ T112			SF2B41	→ TIC106M
MCR3918-7	→ T112	RTV0302	→ T112	SF2D41	→ TIC106M
MCR3918-8	→ T112	RTV0305	→ T112	SF2G41	→ TIC106M
MCR3918-9	→ T112	RTV0310	→ T112	SF2J41	→ TIC106M
MCR3918-10	→ T112	RTV0320	→ T112	SF3B41	→ BT152
		RTV0330	→ T112	SF3D41	→ BT152
RTJ0101	→ BR101	RTV0340	→ T112	SF3G41	→ BT152
RT10103	→ BR103	RTV0350	→ T112	SF3J41	→ BT152
RTJ0106	→ BRX49	RTV0360	→ T112	SF5B41	→ BT152
RTJ0110	→ BRX49	RTV0602	→ T112	SF5D41	→ BT152
RTJ0115	→ BRX49	RTV0605	→ T112	SF5G41	→ BT152
RTJ0203	→ BRX49	RTV0610	→ T112	SF5J41	→ BT152
RTJ0206	→ BRX49	RTV0620	→ T112	SF8B41	→ BT152
RTJ0210	→ BRX49	RTV0630	→ T112	SF8D41	→ BT152
RTJ0215	→ BRX49	RTV0640	→ T112	SF8G41	→ BT152
RTJ0220	→ BRX49	RTV0650	→ T112	SF8J41	→ BT152
RTJ0230	→ BRX49	RTV0660	→ T112		





TIRISTORI I TRIJACI

TIR

PREGLED ZAMENA

TIRISTORI

SH2B41	→	TIC106M	TAG676..	→	TIC126N	TYN058	→	TIC116M
SH2D41	→	TIC106M	TAG4441	→	TIC106D	TYN104	→	TIC106M
SH2G41	→	TIC106M	TAG4442	→	TIC106D	TYN106	→	TIC106M
SIT4/50	→	T112	TAG4443	→	TIC106D	TYN108	→	TIC116M
T3.5N	→	TIC116M	TAG4444	→	TIC106D	TYN110	→	TIC126M
T3N50...	→	T112	TIC44	→	BRX44	TYN112	→	TIC126M
T4.5N50...	→	T112	TIC45	→	BRX45	TYN204	→	TIC106M
T6N100...	→	T112	TIC46	→	BRX46	TYN206	→	TIC106M
T7.5N400	→	TIC126M	TIC47	→	BRX47	TYN208	→	TIC116M
T7N100...	→	TIC126M	TIC101..	→	TIC106M	TYN210	→	TIC126M
T8N100...	→	T112	TIC108..	→	TIC106M	TYN212	→	TIC126M
T10N100...	→	T112	TIC122..	→	TIC126M	TYN404	→	TIC106M
T15.1N100...	→	T112	TXN054..1004	→	TIC116M	TYN406	→	TIC106M
T16N400...	→	T112	TXN056..1006	→	TIC116M	TYN408	→	TIC116M
TAG06..	→	BRY55	TXN058..1008	→	TIC116M	TYN410	→	TIC126M
TAG7..	→	T112	TXN0510..1010	→	TIC126M	TYN412	→	TIC126M
TAG9N..	→	T112	TXN0512..1012	→	TIC126M	TYN0510	→	TIC126M
TAG10..	→	T112	TXS406-05	→	TIC106M	TYN0512	→	TIC126M
TAG14N..	→	T112	TXS406-06	→	TIC106M	TYN604	→	TIC106M
TAG15..	→	T112	TXS406-08	→	TIC106M	TYN608	→	TIC116M
TAG16N..	→	T112	TXS407-05	→	TIC106M	TYN610	→	TIC126M
TAG20..	→	T112	TXS407-06	→	TIC106M	TYN612	→	TIC126M
TAG70..	→	BRY55	TXS407-08	→	TIC106M	TYN804	→	TIC106M
TAG72..	→	BRY55	TY508	→	TIC116M	TYN806	→	TIC116M
TAG103X	→	BR203	TY510	→	TIC126M	TYN808	→	TIC126N
TAG106..	→	TIC106M	TY1004	→	TIC126M	TYN810	→	TIC126N
TAG107..	→	TIC106M	TY1008	→	TIC116M	TYN812	→	TIC126N
TAG108..	→	TIC106M	TY1010	→	TIC126M	TYS406..	→	TIC106M
TAG620..	→	TIC106N	TY2004	→	TIC106M	TYS407..	→	TIC106M
TAG621..	→	TIC106N	TY2008	→	TIC116M	TYS606..	→	TIC116M
TAG625..	→	TIC116N	TY2010	→	TIC126M	TYS607..	→	TIC116M
TAG626..	→	TIC116N	TY3004	→	TIC116M	TYS806..	→	TIC126M
TAG627..	→	TIC116N	TY3008	→	TIC116M	TYS807..	→	TIC126M
TAG630..	→	TIC106N	TY3010	→	TIC126M	X0403..	→	TIC106D
TAG631	→	TIC106N	TY4004	→	TIC106M	X0404..	→	TIC106D
TAG632	→	TIC106N	TY4008	→	TIC116M	X0609	→	TIC106D
TAG655..	→	BT152	TY4010	→	TIC126M	2N681(A)	→	T112
TAG656..	→	TIC116N	TY5004	→	TIC106M	2N682(A)	→	T112
TAG660..	→	TIC116N	TY5008	→	TIC116M	2N683(A)	→	T112
TAG661..	→	TIC116N	TY5010	→	TIC126M	2N684(A)	→	T112
TAG662..	→	TIC116N	TY6004	→	TIC106M	2N685(A)	→	T112
TAG665..	→	TIC126N	TY6008	→	TIC116M	2N686(A)	→	T112
TAG666..	→	TIC126N	TY6010	→	TIC126M	2N687(A)	→	T112
TAG667..	→	TIC126N	TYN054	→	TIC106M	2N688(A)	→	T112
TAG670..	→	BT152	TYN056	→	TIC106M	2N689(A)	→	T112
TAG675..	→	BT152				2N690(A)	→	T112



TIRISTORI I TRIJACI

TIR

PREGLED ZAMENA

TIRISTORI

2N691(A)	→ T112	2N5060	→ BRY55	2N6395	→ TIC126M
2N692(A)	→ T112	2N5061	→ BRY55	2N6396	→ TIC126M
2N876	→ BR103	2N5062	→ BRY55	2N6397	→ TIC126M
2N877	→ BR103	2N5063	→ BRY55	2N6398	→ TIC126M
2N1842	→ T112	2N5064	→ BRY55	2N6399	→ TIC126M
2N1843	→ T112	2N5168	→ T112	2N6605	→ BRX44
2N1844	→ T112	2N5169	→ T112	2N6606	→ BRX45
2N1845	→ T112	2N5170	→ T112	2N6607	→ BRX46
2N1846	→ T112	2N5171	→ T112	2N6608	→ BRX47
2N1847	→ T112	2N5787	→ BRX44		
2N1848	→ T112	2N5788	→ BRX45	40741	→ T112
2N1849	→ T112	2N5789	→ BRX46	40742	→ T112
2N1850	→ T112	2N5790	→ BRX47	40743	→ T112
2N2888	→ T112	2N5791	→ BRX48	40744	→ T112
2N2889	→ T112	2N5792	→ BRX49	40810	→ KT206
2N3273	→ TIC106D	2N6236	→ TIC106M	40811	→ KT206
2N3274	→ TIC106D	2N6237	→ TIC106M	40812	→ KT206
2N3275	→ TIC106D	2N6238	→ TIC106M	40813	→ KT206
2N3276	→ TIC106D	2N6239	→ TIC106M	40833	→ KT505
2N3936	→ T112	2N6240	→ TIC106M	40834	→ KT505
2N3937	→ T112	2N6241	→ TIC106M	40835	→ KT505
2N3938	→ T112	2N6332	→ TIC106D	40867	→ TIC126M
2N3939	→ T112	2N6333	→ TIC106D	40868	→ TIC126M
2N3940	→ T112	2N6334	→ TIC106D	40942	→ TIC106M
2N4441	→ TIC106D	2N6335	→ TIC106D	40943	→ TIC106M
2N4442	→ TIC106D	2N6336	→ TIC106D	40944	→ TIC106M
2N4443	→ TIC106D	2N6337	→ TIC106D	40945	→ TIC106M
2N4444	→ TIC106M	2N6394	→ TIC126M		

TRIJACI

BS6-01A	→ TIC216M	BS7-05A	→ TIC216M	BS9-04A	→ TIC226M
BS6-01B	→ TC112	BS7-06A	→ TIC216M	BS9-05A	→ TIC226M
BS6-02A	→ TIC216M	BS7-07A	→ TIC216M	BS9-06A	→ TIC226M
BS6-02B	→ TC112	BS8-02A	→ TIC226M	BS10-01A	→ TIC236M
BS6-03A	→ TIC216M	BS8-02B	→ TC112	BS10-01B	→ TC112
BS6-03B	→ TC112	BS8-03A	→ TIC226M	BS10-02A	→ TIC236M
BS6-04A	→ TIC216M	BS8-03B	→ TC112	BS10-02B	→ TC112
BS6-04B	→ TC112	BS8-04A	→ TIC226M	BS10-03A	→ TIC236M
BS6-05A	→ TIC216M	BS8-04B	→ TC112	BS10-03B	→ TC112
BS6-05B	→ TC112	BS8-05A	→ TIC226M	BS10-04A	→ TIC236M
BS6-06A	→ TIC216M	BS8-05B	→ TC112	BS10-04B	→ TC112
BS6-06B	→ TC112	BS8-06A	→ TIC226M	BS10-05A	→ TIC236M
BS6-07A	→ TIC216M	BS8-06B	→ TC112	BS10-05B	→ TC112
BS6-07B	→ TC112	BS8-07A	→ TIC226M	BS10-06A	→ TIC236M
BS7-02A	→ TIC216M	BS8-07B	→ TC112	BS10-06B	→ TC112
BS7-03A	→ TIC216M	BS9-02A	→ TIC226M	BS10-07A	→ TIC236M
BS7-04A	→ TIC216M	BS9-03A	→ TIC226M	BS10-07B	→ TC112



CI

TIR

TRIJACI

BCR1AM	→	KT207	BTD0605	→	BT137	BTM1020	→	TIC236M
BCR3AM	→	BT136	BTD0610	→	BT137	BTM1040	→	TIC236M
BCR6AM	→	TIC226M	BTD0620	→	BT137	BTM1060	→	TIC236M
BCR8A	→	TIC226M	BTD0640	→	BT137	BTM1605	→	TIC246M
BCR8CM	→	TIC226M	BTD0660	→	BT137	BTM1610	→	TIC246M
BCR10AM	→	TIC226M				BTM1620	→	TIC246M
BCR10CM	→	TIC226M	BTL0405	→	TIC226M	BTM1640	→	TIC246M
BCR12AM	→	TIC236M	BTL0410	→	TIC226M	BTM1660	→	TIC246M
BCR12CM	→	TIC236M	BTL0420	→	TIC226M			
BCR12DM	→	TIC236M	BTL0440	→	TIC226M	BTW13	→	TC112
BCR12EM	→	TIC236M	BTL0460	→	TIC226M	BTW16	→	TC112
BCR16AM	→	TIC246N	BTL0605	→	TIC226M	BTW18	→	TC112
BCR16C	→	TIC246N	BTL0610	→	TIC226M	BTW37	→	TC112
BCR16CM	→	TIC246N	BTL0620	→	TIC226M	BTW41	→	BTA41
BCR16DM	→	TIC246N	BTL0640	→	TIC226M	BTW43	→	TC112
BCR16EM	→	TIC246N	BTL0660	→	TIC226M			
			BTL0805	→	TIC226M	BTX0605	→	KT728
BT158	→	TIC236M	BTL0810	→	TIC226M	BTX0610	→	KT728
BT162	→	TIC236M	BTL0820	→	TIC226M	BTX0620	→	KT728
			BTL0840	→	TIC226M	BTX0640	→	KT728
BTA20	→	TIC226M	BTL0860	→	TIC226M	BTX0660	→	KT728
BTA21	→	TIC226M	BTL1005	→	TIC236M	BTX1005	→	KT728
BTA22	→	TIC236M	BTL1010	→	TIC236M	BTX1010	→	KT728
BTA23	→	TIC236M	BTL1020	→	TIC236M	BTX1020	→	KT728
BTA25	→	BTA26	BTL1040	→	TIC236M	BTX1040	→	KT728
BTA40	→	BTA41	BTL1060	→	TIC236M	BTX1060	→	KT728
			BTL1605	→	TIC246M	BTX1605	→	KT728
BTB04	→	BTA04	BTL1610	→	TIC246M	BTX1610	→	KT728
BTB06	→	BTA06	BTL1620	→	TIC246M	BTX1620	→	KT728
BTB08	→	BTA08	BTL1640	→	TIC246M	BTX1640	→	KT728
BTB10	→	BTA10	BTL1660	→	TIC246M	BTX1660	→	KT728
BTB12	→	BTA12						
BTB15	→	BTA16	BTM0405	→	TIC226M	FSM3B2	→	TIC206M
BTB16	→	BTA16	BTM0410	→	TIC226M	FSM3B4	→	TIC206M
BTB19	→	BTA26	BTM0420	→	TIC226M	FSM6B2	→	TIC216M
BTB24	→	BTA26	BTM0440	→	TIC226M	FSM6B4	→	TIC216M
BTB25	→	BTA26	BTM0460	→	TIC226M	FSM10B2	→	TIC236M
BTB40	→	BTA41	BTM0605	→	TIC226M	FSM10B4	→	TIC236M
BTB41	→	BTA41	BTM0610	→	TIC226M	FSM16C2	→	TIC246M
			BTM0620	→	TIC226M	FSM16C4	→	TIC246M
BTD0105	→	BT136	BTM0640	→	TIC226M	FSM16C6	→	TIC246M
BTD0110	→	BT136	BTM0660	→	TIC226M			
BTD0120	→	BT136	BTM0805	→	TIC226M	FT08	→	TC112
BTD0140	→	BT136	BTM0810	→	TIC226M	FT12	→	TIC216M
BTD0160	→	BT136	BTM0820	→	TIC226M			
BTD0305	→	BT136	BTM0840	→	TIC226M	FU12	→	TIC206M
BTD0310	→	BT136	BTM0860	→	TIC226M			
BTD0320	→	BT136	BTM0880	→	TIC226M	KT729	→	TC112
BTD0340	→	BT136	BTM1005	→	TIC236M	KT730	→	TC112
BTD0360	→	BT136	BTM1010	→	TIC236M	KT772	→	TC112
						KT773	→	TC112

18000 Ni, Jovana Ristića 7, P.O.Box 135, Tel: 018 / 520-455, 522-814, 522-965, fax: 522-660
<http://www.MGelectronic.co.yu> e-mail: office@MGelectronic.co.yu



TIRISTORI I TRIJACI

TIR

PREGLED ZAMENA

TRIJACI

KT774	→ TC112	MAC228-4	→ TIC225M	T1512..	→ TIC246N
KT782	→ TC112	MAC228-5	→ TIC225M	T2301..	→ TIC206M
KT783	→ TC112	MAC228-6	→ TIC225M	T2302..	→ TIC206M
KT784	→ TC112	MAC228-7	→ TIC225M	T2303..	→ TIC206M
		MAC228-8	→ TIC225M	T2304..	→ TIC201M
MAC10-1	→ TIC236M	MAC800-02	→ TIC206M	T2305..	→ TIC201M
MAC10-2	→ TIC236M	MAC3030-4	→ BTA04	T2306..	→ TIC201M
MAC10-3	→ TIC236M	MAC3030-8	→ BTA08	T2310..	→ TIC201M
MAC10-4	→ TIC236M			T2311..	→ TIC201M
MAC10-5	→ TIC236M	S6131D	→ TIC236M	T2312..	→ TIC201M
MAC10-6	→ TIC236M	S6131G	→ TIC236M	T2313..	→ TIC201M
MAC10-7	→ TIC236M	SC136	→ BT136	T2316..	→ TIC201M
MAC10-8	→ TIC236M	SC141	→ TIC216M	T2320..	→ BT136
MAC11-1	→ TIC236M	SC146	→ TIC236M	T2322..	→ BT136
MAC11-2	→ TIC236M	SC149	→ TIC236M	T2323..	→ BT136
MAC11-3	→ TIC236M	SC159	→ TIC246M	T2327..	→ BT136
MAC11-4	→ TIC236M	SC245	→ TC112	T2500..	→ TIC216M
MAC11-5	→ TIC236M	SC250	→ TC112	T2800..	→ TIC226M
MAC11-6	→ TIC236M	SC260	→ TC112	T2801..	→ TIC216M
MAC11-7	→ TIC236M			T2802..	→ TIC216M
MAC15-4	→ TIC246M	SM3B41	→ TIC206M	T2805..	→ TIC226M
MAC15-6	→ TIC246M	SM3D41	→ TIC206M	T2806	→ TIC226M
MAC15-8	→ TIC246M	SM3G41	→ TIC206M	T2850	→ TIC226M
MAC15-10	→ TIC246N	SM3J41	→ TIC206M	T2851	→ TIC226M
MAC77-1	→ TIC206M	SM8D41	→ TIC226M	T2856	→ TIC226M
MAC77-2	→ TIC206M	SM8G41	→ TIC226M	T4110..	→ TC112
MAC77-3	→ TIC206M	SM8J41	→ TIC226M	T4111..	→ TC112
MAC77-4	→ TIC206M	SM12D41	→ BT138	T4113..	→ TC112
MAC77-5	→ TIC206M	SM12G41	→ BT138	T4114..	→ TC112
MAC77-6	→ TIC206M	SM12J41	→ BT138	T4115..	→ TC112
MAC77-7	→ TIC206M			T4116..	→ TC112
MAC77-8	→ TIC206M	T0505..	→ TIC216M	T4117..	→ TC112
MAC216-4	→ TIC216M	T0509..	→ TIC216M	T4700..	→ TIC246M
MAC216-6	→ TIC216M	T0510..	→ TIC216M	T6000..	→ TIC246N
MAC216-7	→ TIC216M	T0512..	→ TIC216M	T6001..	→ TIC246N
MAC216-8	→ TIC216M	T0605..	→ TIC216M	T6006..	→ TIC246N
MAC220-2	→ TIC226M	T0609..	→ TIC216M		
MAC220-3	→ TIC226M	T0610..	→ TIC216M	TAG96..	→ TIC206M
MAC220-4	→ TIC226M	T0612..	→ TIC216M	TAG136..	→ BT136
MAC220-7	→ TIC226M	T0805..	→ TIC225M	TAG137..	→ BT137
MAC220-9	→ TIC226M	T0809..	→ TIC225M	TAG138..	→ BT138
MAC221-2	→ TIC226M	T0810..	→ TIC225M	TAG220..	→ TIC226M
MAC221-3	→ TIC226M	T0812..	→ TIC225M	TAG221..	→ TIC216M
MAC221-5	→ TIC226M	T0813..	→ TIC225M	TAG222..	→ TIC216M
MAC221-7	→ TIC226M	T1010..	→ TIC236N	TAG224..	→ TIC226M
MAC221-9	→ TIC226M	T1012..	→ TIC236N	TAG225..	→ TIC226M
MAC228-2	→ TIC225M	T1013..	→ TIC236N	TAG226..	→ TIC225M
MAC228-3	→ TIC225M	T1210..	→ TIC236N	TAG227..	→ TIC225M
		T1212..	→ BT138		





TIRISTORI I TRIJACI

TIR

PREGLED ZAMENA

TRIJACI

TAG230..	→	TIC206M	TXC10L..	→	BT136	2N6344A	→	TIC236M
TAG231..	→	TIC206M	TXC18..	→	TIC226M	2N6345	→	TIC226N
TAG232..	→	TIC206M				2N6345A	→	TIC236N
TAG233..	→	TIC206M	TXD10H..	→	TIC226M	2N6346	→	BT137
TAG240..	→	TIC226M	TXD10K..	→	TIC236M	2N6346A	→	BT138
TAG241..	→	TIC225M	TXD10L..	→	BT138	2N6347	→	BT137
TAG245..	→	TIC226M	TXD96A20..	→	TC112	2N6347A	→	BT138
TAG246..	→	TIC225M	TXD99A20..	→	TC112	2N6348	→	BT137
TAG250..	→	TIC226M				2N6348A	→	BT138
TAG251..	→	TIC226M	TXDV208	→	TIC226M	2N6349	→	TIC226N
TAG252..	→	TIC226M	TXDV212	→	TIC236M	2N6349A	→	TIC236N
TAG255..	→	TIC236N	TXDV408	→	TIC226M			
TAG256..	→	TIC236N	TXDV412	→	TIC236M	40668	→	BT137
TAG257..	→	TIC236N	TXDV608	→	TIC226M	40669	→	BT137
TAG270..	→	TC112	TXDV612	→	TIC236M	40670	→	BT137
TAG271..	→	TC112	TXDV808	→	TIC236M	40684	→	BT136
TAG275..	→	TC112	TXDV812	→	TIC236N	40685	→	BT136
TAG276..	→	TC112				40686	→	BT136
TAG280..	→	TIC246N	TYAL116..	→	TIC216M	40687	→	BT136
TAG281..	→	TIC246N	TYAL118..	→	TIC226M	40691	→	BT136
TAG307..	→	TC112	TYAL226..	→	TIC226M	40692	→	BT136
TAG310..	→	TC112	TYAL228..	→	TIC226N	40713	→	TC112
TAG350..	→	TC112	TYAL386..	→	TIC216M	40714	→	TC112
TAG351..	→	TC112	TYAL388..	→	TIC216N	40719	→	TC112
TAG420..	→	TIC226M	TYAL1110..	→	TIC236M	40720	→	TC112
TAG421..	→	TIC225M	TYAL1115..	→	TIC246M	40723	→	TIC216M
TAG425..	→	TIC226M	TYAL2210..	→	TIC236M	40724	→	TIC216M
TAG426..	→	TIC225M	TYAL2215..	→	TIC246M	40725	→	TIC216M
TAG451..	→	TIC226M	TYAL3810..	→	TIC236N	40726	→	TIC216M
TAG452..	→	TIC225M	TYAL3815..	→	TIC246N	40761	→	TIC206M
TAG457..	→	TIC236M	Z0405..	→	TIC206N	40762	→	TIC206M
TAG480..	→	TIC236M	Z0409..	→	TIC206N	40769	→	TIC206M
TAG481..	→	TIC236M	Z0410..	→	TIC216N	40770	→	TIC206M
						40771	→	TIC206M
TIC222..	→	TC112	2N5573	→	TC112	40772	→	TIC206M
TIC232..	→	TC112	2N5574	→	TC112	40773	→	TIC206M
TIC242..	→	TC112	2N6068	→	TIC206M	40774	→	TIC206M
			2N6069	→	TIC206M	40900	→	BT137
TW6N...	→	TC112	2N6070	→	TIC206M	40901	→	BT137
TW7N..	→	TIC226N	2N6071	→	TIC206M	40902	→	BT137
TW8N..	→	TC112	2N6072	→	TIC206M			
TW9N..	→	TIC236N	2N6073	→	TIC206M			
TW10N..	→	TC112	2N6074	→	TIC206M			
TW11N..	→	TIC236N	2N6075	→	TIC206M			
TW12N..	→	TC112	2N6342	→	TIC226M			
			2N6342A	→	TIC236M			
TXAL1115	→	TIC246N	2N6343	→	TIC226M			
			2N6343A	→	TIC236M			
TXC10H..	→	BT136	2N6344	→	TIC226M			
TXC10K..	→	BT136						

OBELEZAVANJE NAPONA

Q	15V	A	100V	E	500V
U	25V	B	200V	M	600V
Y	30V	C	300V	S	700V
F	50V	D	400V	N	800V