

3-PHASE CAGE INDUCTION MOTORS TOTALLY ENCLOSED (IP 55)

GENERAL-PURPOSE INDUSTRIAL USE



IEC Frame sizes
 56...355

CONTENTS

• DESIGNATION OF MOTORS.....	2
• STANDARDS AND RECOMMENDATIONS.....	2
• MECHANICAL DESIGN	
Frames, end-shields and flanges.....	3
Enclosure degrees of protection.....	3
Cooling.....	4
Terminal box.....	4
Cable entry.....	4
Bearings.....	5
Standard design with single row deep groove ball bearings.....	5
- Arrangement of bearings.....	5
Reinforced design with cylindrical roller bearing.....	6
- Arrangement of bearings.....	6
Maintenance of bearings.....	6
Permissible mechanical forces.....	6
- Permissible radial loads.....	6
- Standard design with single row deep groove ball bearing.....	7
- Reinforced design with cylindrical roller bearing.....	7
- Permissible external axial loads.....	8
- Standard design with single row deep groove ball bearing.....	8
- Reinforced design with cylindrical roller bearing.....	9
Shaft extensions.....	10
Vibration.....	10
Noise level.....	10
Painting.....	10
Storage.....	10
Type of construction and mounting arrangements.....	11
• ELECTRICAL DESIGN	
Voltage and frequency.....	12
Rated output.....	12
Environmental conditions.....	12
Over-load capacity.....	13
Rated torque.....	13
Insulation class.....	13
General Information on frequency converter fed A.C. cage induction motors.....	13
* Speed control of A.C. cage induction motors.....	13
* Reducing the speed of an A.C. cage induction motor below its rated speed.....	14
* Increasing the speed of an A.C. cage induction motor above its rated speed.....	14
Duty types.....	15
Starting frequency.....	16
Starting time.....	17
Terminal connections and starting of motors.....	18
* Direct-on-line starting.....	18
* Star/Delta (Y/ Δ) Starting.....	18
* Soft starting.....	18
* Auto-transformer Starting.....	18
Electrical protection of motors.....	18
Tolerances.....	19
Information required when ordering motors.....	19
Efficiency and power factor at various loads.....	20
• RATINGS AND PERFORMANCE	
- (EFF1) High efficiency motors to CEMEP	
2 Pole, 3000 min ⁻¹	21
4 Pole, 1500 min ⁻¹	21
- (EFF2) Improved efficiency motors to CEMEP	
2 Pole, 3000 min ⁻¹	22
4 Pole, 1500 min ⁻¹	23
6 Pole, 1000 min ⁻¹	24
8 Pole, 750 min ⁻¹	25
• DIMENSIONS	
Foot-mounted motors.....	26
D-Flange-mounted motors : Flange Form A-DIN 42 948.....	27
C-Face-Flange mounted motors : Flange Form C-DIN 42 948.....	28
Foot and D-Flange mounted motors : Flange Form A-DIN 42 948.....	29
Foot and C-Face-Flange mounted motors : Flange Form C-DIN 42 948.....	30
• SPARES.....	31

We reserve the right to alter or delete, fully or partly the technical specifications given in this brochure without prior notice.

DESIGNATIONS OF MOTORS

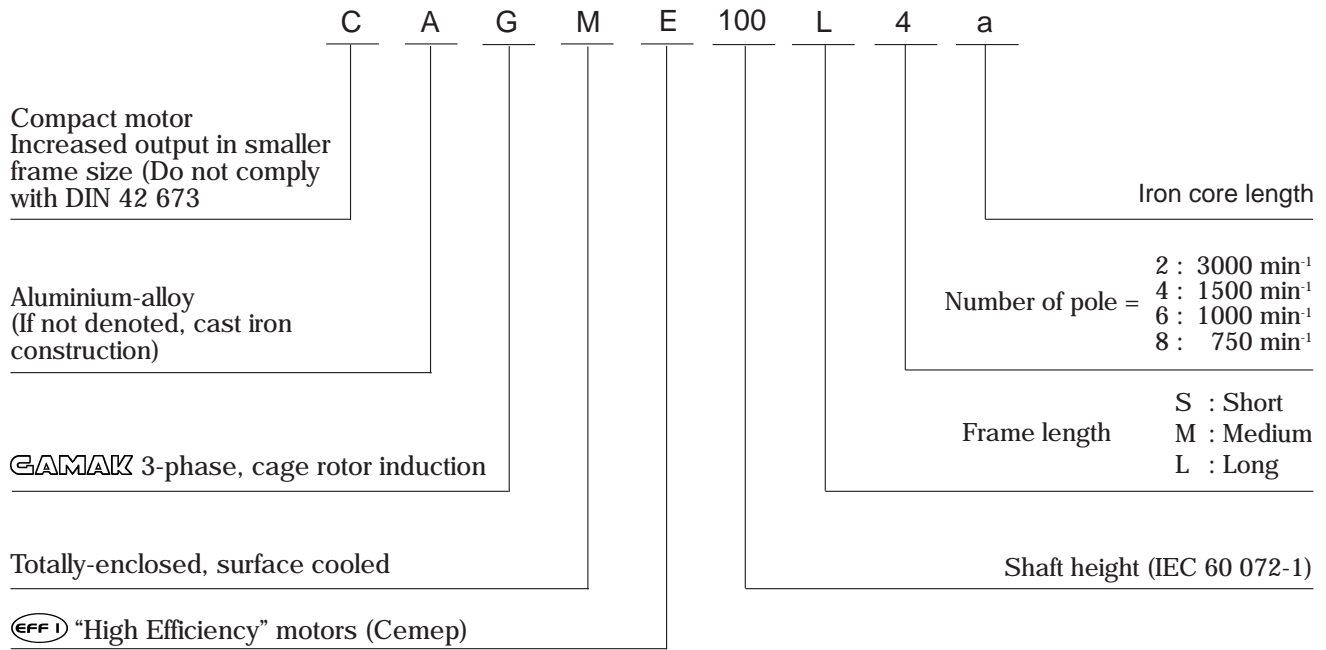

STANDARDS AND RECOMMENDATIONS

This catalogue deals with mechanical and electrical features of 3-phase, cage-rotor, totally enclosed, general purpose industrial use induction motors of frame sizes ranging from 56 up to 355 which give the distance from center-line of shaft to bottom of foot in mm, in accordance with IEC (International Electrotechnical Commission) Recommendations.

GAMAK induction motors are designed, manufactured and tested according to the following standards and recommendations.

IEC	DIN/EN	
* 60 072-1	DIN 42 673 T1	Dimensions and output ratings of foot mounted motors (IM B3). Relationship between frame sizes and output ratings.
* 60 072-1	DIN 42 677 T1	Dimensions and output ratings of flange mounted motors (IM B5, B10, B14). Relationship between frame-sizes and output ratings.
** 60 034-1	DIN EN 60 034-1	Rating and performance.
60 034-5	DIN EN 60 034-5	Classification of degrees of protection provided by enclosures.
60 034-6	DIN EN 60 034-6	Methods of cooling.
60 034-7	DIN EN 60 034-7	Symbols for types of construction and mounting arrangements.
60 072-1	DIN 42 948 DIN 42 955	Mounting flanges. Tolerances of shaft extension run-out, and of mounting flanges; testing.
60 034-8	DIN VDE 0530 Part 8	Terminal markings and direction of rotation.
60 034-9	DIN EN 60 034-9	Noise limits.
60 034-11	-	Built-in thermal protection; rules for protection.
60 034-12	DIN EN 60 034-12	Starting performance of single-speed motors.
60 034-14	DIN EN 60 034-14	Measurement, evaluation and limits of the vibration severity.
60 038	DIN IEC 60 038	Standard voltages.
60 085	VDE 0530 T1	Classifications of materials for the insulation of electrical machineries in relation to their thermal stability in service.
	DIN 42 925	Terminal-box cable entries.
60 072-1	DIN 748 T3	Cylindrical shaft-ends.

* IEC 60 072-1 specifies only dimensions and output ratings of both foot and flange mounted 3-phase cage induction motors (TEFV) but does not furnish the relationship between frame sizes and output ratings.

** BS 5000 and BS 4999 are harmonized with IEC 60 034-1 or replaced by DIN EN 60 034-1.

MECHANICAL DESIGN

Frames, end-shields and flanges

Frame sizes 56 to 132 : The motor frames, end-shields and flanges are pressure die-cast in a corrosion resistant aluminium alloy (except flange type B14/F165 in frame size 112 and B14/F165, F215 in frame size 132, which are cast iron).

Frame size 160 to 355 : The motor frames, end-shields and flanges are cast iron.

The feet of all motors are cast integrally with frames.

Frame size 132 has two integrally-cast eyebolts. Frame sizes 160 to 355 are supplied with lifting eye-bolt (DIN 580).

Enclosure degrees of protection

The degrees of protection are specified in accordance with IEC publication 60 034-5, by means of letters IP (International Protection) followed by two characteristic numerals.

Symbol	First Numeral	Second Numeral
		Protection against contact and ingress of foreign bodies.
IP 55	Complete protection against contact with live or moving parts inside the enclosure. The ingress of dust is not totally prevented, but dust does not enter in sufficient quantity to interfere with satisfactory operation of the motor.	Water projected by a nozzle against the motor from any direction will have no harmful effect.
IP 56		Water from heavy seas or water projected in powerful jets will not enter the motor in harmful quantities.

Note: IEC 60 034-5 does not specify types of protection of machines for the use in an explosive atmosphere, as well as degrees of protection against mechanical damage of the machine or, conditions such as moisture (produced by condensation), corrosive vapours, fungus or vermin.

All standard range **GAMAK** motors are totally enclosed and comply with IP 55 degree of protection suitable for use in dusty and damp surroundings. There is no need of special measures to be taken for protecting the standard range motors against the effects of moderate ambient conditions when they are properly installed outdoors. Motors must be protected against direct sun-rays.

However, the following protective measures have to be taken against extremely severe climatic conditions such as out-door operation, dampness, chemical and coastal corrosive atmospheres :

- Special protective paint finish,
- Degree of protection IP 56,
- Special varnishing of coil-heads against high humidity,
- For all out-door installations and vertical mounting arrangements, the following precautions are to be taken. The efficiency of motors must always be maintained.
 - Shaft down : Protective cover (Canopy),
 - Shaft up : Special protective cover or additional bearing-seal to prevent the ingress of water.
- Precautions against water condensation phenomenon are :
 - Providing drain holes at both sides of motors which are best positioned to suit the particular mounting arrangement.
 - Motor enclosure degree of protection will reduce to IP 44 if drain plugs are removed.

Where motors are left standing for long periods in damp conditions or where condensation is likely, we recommend that heaters are fitted. They should be energised whenever the motor is turned off to prevent condensation forming within the motor enclosure.

Recommended heater ratings

Frame size	Heater	
	Supply voltage V	Rating W
56... 71	110 or 220	16
80...100		40
112...180		60
200...280		80
315...355		120

Alternatively, a low voltage of 5 to 10% of motor rated voltage and a current of 20 to 30% of motor rated current applied to the stator terminals U₁ and V₁ via an auto-transformer, after the main supply is switched off, will provide an adequate heating.

Cooling (IEC 60 034-6)

Motors of frame size 56 have no cooling-fan (IC 410). Cooling is maintained by free convection.

Motors of frame sizes 63 to 355 are surface cooled by means of an external radial flow cooling-fan (IC 411) which is protected by a steel sheet cowl with standard test-finger proof openings for sufficient air flow. The cooling-fan is fixed onto the non-drive end of the motor shaft and operates independent of the direction of rotation. The cooling-fans are injection mould high grade polyamide.

Terminal box

All the terminal boxes comply with degree of protection IP 55, and are placed to the front and on top of motor frames, allowing an easy cable entry from both sides. In the basic design, the motors have six fixed terminals, and are fitted with an earthing-screw inside the terminal box. A connection diagram is provided in the cover of each terminal-box.

The terminal boxes of frame sizes 56 to 132 are injection mould, high-grade reinforced polyamide, the sizes 160 to 280 are pressure die-cast in corrosion resistant aluminium alloy and sizes 315 and 355 are in cast iron.

Cable entry

The entry of the cable to the terminal box as per DIN 42 925 is maintained by means of compression glands produced to DIN 46 320 or water resistant (IP 68) compression glands on request.

Frame size	56	63	71	80	90	100	112	132	160	180	200	225	250	280	315	355
Dimension of compression glands	Pg 11		Pg 16				Pg 21	Pg 29		Pg 36		Pg 42		Pg 48	M72	
Number of compression glands	1				2											
Maximum cable outer diameter mm	11		16				21	29		36		42		48	59	
Maximum conductor cross section total mm ²	1.5		2.5				6	16		50		120		240	400	
Terminal size	M4x12				M5x15		M6x24			M8x28		M10x24	M12x43	M16x55		

Bearings

The motors are fitted with high quality noise tested single-row deep-groove radial ball-bearings (DIN 625) or cylindrical roller bearings (DIN 5412).

Single-row deep groove radial ball bearing design is the standard bearing arrangement of **GAMAK** electric motors. The maximum radial and axial forces which can be subjected to the bearings of standard design (Fig. 1, 2 and 3) are given at page 7 and 8. Reinforced design with cylindrical roller bearing (Fig. 4) should be considered in motors above frame size 160 where external radial force applied on shaft extension is greater than the values given for standard design at page 7. Please consult us if the external axial load subjected on the bearings is even greater than the values given for reinforced design at page 7 as special bearing arrangement may be required.

Standard design with single row deep groove ball bearings

Frame size	No. of pole	D End	N.D. End	Fig. No.
56	2-4-6-8	6200 ZZ		1
63	2-4-6-8	6201 ZZ		
71	2-4-6-8	6202 ZZ		
80	2-4-6-8	6204 ZZ		
90	2-4-6-8	6205 ZZ		
100-112	2-4-6-8	6206 ZZ		
132	2-4-6-8	6208 ZZ		
160	2-4-6-8	6309 ZZ C3	6209 ZZ C3	2
180	2-4-6-8	6310 ZZ C3	6210 ZZ C3	

Frame size	No. of pole	D End	N.D. End	Fig. No.
200	2-4-6-8	6312 ZZ C3	6212 ZZ C3	2
225	2-4-6-8	6313 ZZ C3	6213 ZZ C3	
250	2-4-6-8	6315 ZZ C3	6215 ZZ C3	
280	2	6315 ZZ C3		
	4-6-8	6316 ZZ C3		3
315	2	6217 C3		
	4-6-8	6318 C3		
355	2	6217 C3		
	4-6-8	6321 C3		

Single row deep groove ball bearings are pre-loaded in the axial direction by corrugated disc springs (Fig. 1 and 2) and helical compression springs (Fig. 3) in order to ensure smooth running (reduced vibrations and noise) which in turn allow the attainment of max. bearing life.

Arrangement of bearings

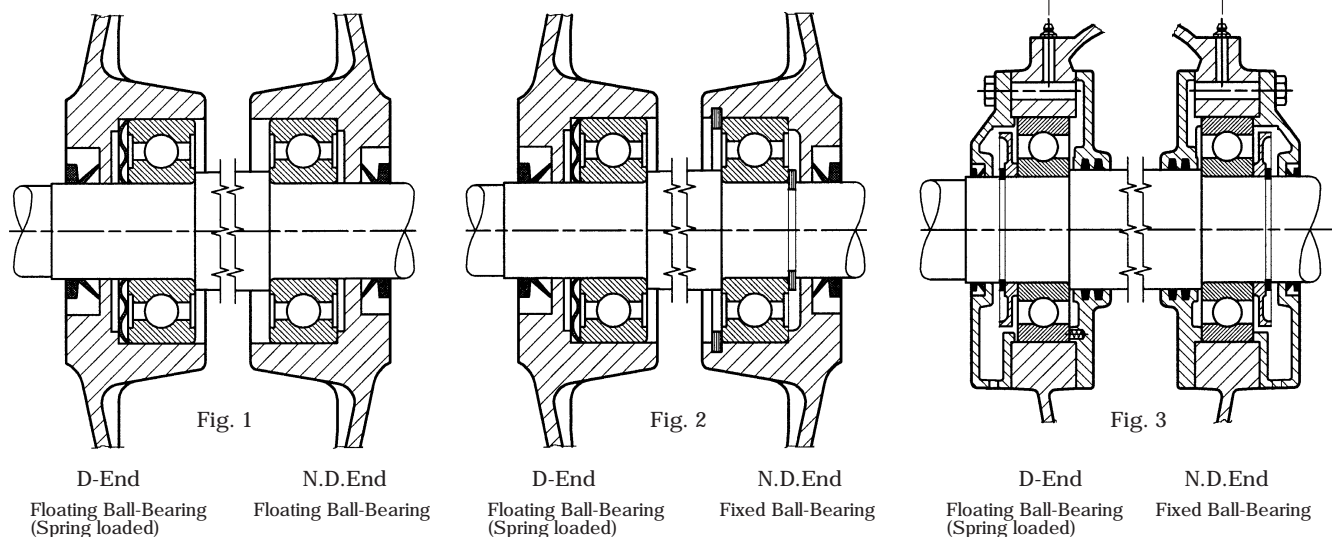

Motors of frame sizes 56 to 280 (Fig. 1 and 2) have double shielded ZZ bearings which are factory grease packed/sealed for life.

On request, motors of frame sizes 56 to 132 can be manufactured in fixed bearing design (Fig. 2) in order to avoid the movement of the shaft in axial direction.

Motors of frame sizes 315 and 355 (Fig. 3) have open type single-row deep groove ball bearings and are equipped with greasing nipples for re-lubrication during operation. The grease retaining disc between the bearing and the external bearing cap, keeps the grease in the bearing.

On request, motors of frame sizes 160 to 250 can be manufactured in identical bearing design by using same size ZZ (both sides sealed) or open type (greasing nipped) bearings at both ends. This design is capable of carrying greater external axial forces. Please consult us for the values of permissible external axial forces.

Rubber V-ring sealings are fitted at both drive and non drive end. Oil seals may be foreseen on request.

Reinforced design with cylindrical roller bearing (For excessive radial forces)

Reinforced design with cylindrical roller bearings is recommended for applications like belt and pulley drives where external radial forces may be greater than stipulated at page 7.

Frame size	No. of pole	D End	N.D. End	Fig. No.
160	2-4-6-8	NU 309 E	6309 C3	4
180	2-4-6-8	NU 310 E	6310 C3	
200	2-4-6-8	NU 312 E	6312 C3	
225	2-4-6-8	NU 313 E	6313 C3	
250	2-4-6-8	NU 315 E	6315 C3	
280	2	NU 315 E	6315 C3	
	4-6-8	NU 316 E	6316 C3	
315	2	NU 217 E	6217 C3	
	4-6-8	NU 318 E	6318 C3	
355	2	NU 217 E	6217 C3	
	4-6-8	NU 321 E	6321 C3	

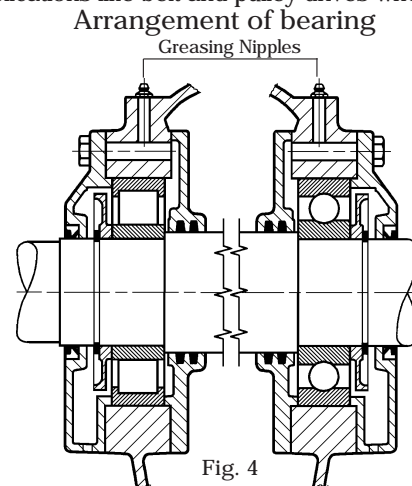

Fig. 4
D-End : Cylindrical Roller Bearing N.D.End : Fixed Ball-Bearing

In case the external radial force subjected to the bearing of motors having reinforced design with cylindrical roller bearing (NU series) is too small during operation, slippage occurs between the rollers and raceways which may result in smearing. Please consult us if radial force is very small or strong shock loads or vibration are expected as special bearing arrangements may be required.

The reinforced design with cylindrical roller bearing is manufactured with greasing nipples in frame sizes 160 to 355.

Maintenance of Bearings

Bearings are recommended to be lubricated with a grease having lithium soap as thickener and mineral oil which contains oxidation and corrosion inhibitors (Antifriction bearing greases K3 to DIN 51 825, range of working temperature $-30^{\circ}\text{C} \dots +140^{\circ}\text{C}$). However, a grease suitable for working conditions should be used if the motor is going to be operated beyond rated ambient temperature limits.

The amount of grease to be filled in the bearing should be around 1/3 of its internal volume. Rule of thumb; the inner diameter of the bearing in mm corresponds to the minimum amount of grease to be used in g.

The regreasable bearings (Fig. 3 and 4) have to be relubricated as per the recommendations given at page 10 of our General Instructions Manual. However, the re-lubrication should be done after 3 years of operation at the latest or more frequently where unfavourable operating conditions prevail.

In case the bearings of the motor is not subjected to any axial or radial forces, the nominal life of bearings is minimum 40 000 hrs. The permissible radial and axial forces given at pages 7, 8 and 9 are calculated according to 20 000 hrs nominal life at 50 Hz frequency. In practice, the majority of the bearings attain a much longer life.

Shaft of motors are ground to extremely fine limits to ensure a perfect fit and interchangeability of bearings.

Permissible mechanical forces

The permissible axial and radial forces are given in the following tables in Newton (N). In case the given axial and radial forces are to be exceeded, the following information has to be specified when ordering, in order to determine the correct bearing arrangement and shaft size:

Frame size, type of construction and mounting arrangement, type of duty, point of load application, nature of load (magnitude, direction, constant, or varying), type of machine to be driven, type of drive (Pulley, toothwheel, coupling, etc.)

Permissible radial loads

F_r = Radial force (N)

X = The distance (mm) from the shoulder of the shaft to the line of application of the force. Dimension X_{max} is thus the length of free shaft extension. Centre line of pulley must be within the free shaft extension.

$$F_r = 1.91 \cdot \frac{P \cdot k}{D \cdot n} \cdot 10^7 \quad (\text{N})$$

P : Motor output (kW)

n : Full-load speed (min^{-1})

D : Pulley diameter (mm)

k : Belt tension factor (Approx.)

- 2 for flat belt with idler pulley drives.
- 2.25 for V-belt drives.
- 3 for flat and poly V-belt without idler pulley drives.

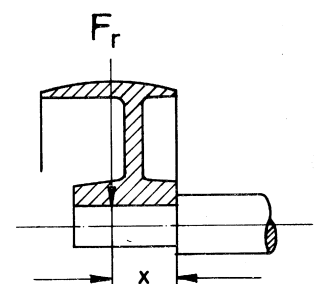

Permissible radial loads

Standard design with single row deep groove ball bearing (Axial force $F_a = 0$)

Frame size	3000 min ⁻¹		1500 min ⁻¹		1000 min ⁻¹		750 min ⁻¹	
	X ₀ N	X _{max} N	X ₀ N	X _{max} N	X ₀ N	X _{max} N	X ₀ N	X _{max} N
56	260	230	330	290	-	-	-	-
63	350	300	450	390	-	-	-	-
71	400	340	510	430	580	490	640	540
80	660	540	840	680	980	800	1070	880
90	740	600	930	760	1070	870	1190	970
100	1040	830	1310	1050	1500	1210	1670	1340
112	1040	840	1300	1050	1490	1210	1650	1340
132	1520	1220	1940	1560	2220	1790	2490	2000
160	2800	2230	3520	2800	4050	3220	4470	3560
180	3230	2630	4090	3330	4710	3830	5180	4210
200	4290	3540	5450	4500	6220	5140	6900	5700
225	4780	3980	6030	4810	6880	5500	7650	6100
250	5800	4730	7330	6000	8420	6870	9230	7540
280	5770	4800	7860	6610	9040	7600	10100	8480
315	3730	3200	8760	7270	9910	8220	11100	9180
355	3300	2820	10400	8620	12300	10100	13700	11300

Reinforced design with cylindrical roller bearing (Axial force $F_a = 0$)

Frame size	3000 min ⁻¹		1500 min ⁻¹		1000 min ⁻¹		750 min ⁻¹	
	X ₀ N	X _{max} N	X ₀ N	X _{max} N	X ₀ N	X _{max} N	X ₀ N	X _{max} N
160	6890	5490	8480	6750	9620	7660	10500	8370
180	7730	6270	9540	7750	10800	8790	11800	9580
200	10600	8740	13100	10800	14700	12200	16100	13300
225	12600	10500	15600	12400	17600	14000	19300	15400
250	16700	13700	20700	16900	23400	19100	25400	20700
280	16800	14200	22100	18600	25000	21000	27400	23000
315	11500	9800	28900	23700	32600	26800	35600	29200
355	11000	9400	26100	21500	29700	24500	32600	26900

Permissible external axial loads

Standard design with single row deep groove ball bearing

Frame size	Horizontal Shaft					Vertical Shaft									
	Tensile	Thrust			Shaft down					Shaft up					
		Without F_r	With max. F_r at		Without F_r	Force down		Force up			Force down		Force up		
	X_o		X_{max}	X_o		X_{max}	F_r	X_o	X_{max}	F_r	X_o	X_{max}	F_r	X_o	X_{max}
N	N	N	N	N	N	N	N	N	N	N	N	N	N	N	N

2 pole (3000 min⁻¹)

56	50	140	120	180	40	40	40	140	130	190	130	120	170	60	60	60
63	80	170	150	220	70	70	70	180	150	230	160	140	210	90	90	90
71	100	190	160	240	90	90	90	200	170	250	170	140	230	110	110	110
80	140	320	270	410	120	120	120	340	280	430	300	250	400	160	160	160
90	160	350	290	430	130	130	130	370	320	470	310	250	410	190	190	190
100	220	490	400	590	170	170	170	520	440	650	430	340	560	270	270	270
112	220	490	410	590	160	160	160	530	450	660	420	340	550	280	280	280
132	350	710	580	820	200	200	200	820	690	1000	530	400	700	500	500	500
160	1650	1090	840	1230	1210	950	1470	1270	1010	1530	790	530	1050	1690	1430	1950
180	1820	1190	920	1300	1250	980	1550	1460	1190	1760	740	460	1030	1980	1710	2270
200	2590	1910	1590	2090	1830	1490	2230	2270	1940	2670	1330	990	1730	2770	2440	3170
225	2820	2070	1730	2260	1920	1560	2390	2510	2150	2970	1360	1000	1830	3070	2710	3530
250	3120	2410	1950	2580	1990	1510	2530	3000	2520	3540	1450	980	1990	3530	3060	4080
280	5200	4420	4040	4670	3710	3280	4420	5250	4810	5950	3180	2740	3880	5780	5350	6490
315	3340	3150	3380	3340	1160	880	1660	5570	5280	6060	1160	880	1660	5570	5280	6060
355	3010	2820	3020	3010	*	*	*	6830	6540	7310	*	*	*	6830	6540	7310

4 pole (1500 min⁻¹)

56	50	210	190	260	40	40	40	210	190	270	200	180	260	60	60	60
63	80	270	240	330	70	70	70	270	240	350	260	230	330	90	90	90
71	100	290	250	360	90	90	90	300	260	370	270	230	340	110	110	110
80	140	490	420	610	120	120	120	510	440	640	460	390	590	160	160	160
90	160	540	460	650	120	120	120	570	490	700	490	410	620	200	200	200
100	220	740	630	880	150	150	150	790	680	970	660	540	830	290	290	290
112	220	750	640	870	130	130	130	810	700	980	640	530	810	310	310	310
132	350	1090	920	1240	180	180	180	1210	1040	1450	880	710	1120	520	520	520
160	2110	1510	1180	1690	1540	1200	1880	1740	1400	2090	1120	780	1460	2160	1820	2510
180	2340	1660	1310	1820	1630	1260	2020	1990	1620	2380	1110	740	1500	2510	2140	2900
200	3370	2610	2180	2870	2440	1990	2970	3020	2570	3560	1940	1490	2470	3520	3070	4060
225	3650	2860	2300	3090	2480	1900	3100	3410	2840	4030	1920	1340	2540	3970	3400	4590
250	4060	3290	2680	3520	2610	1980	3340	4010	3380	4740	2080	1450	2800	4550	3920	5270
280	7060	6720	6240	7060	4900	4290	5910	7970	7360	8980	4900	4290	5910	7970	7360	8980
315	7840	7440	7390	7840	4620	3870	5750	10200	9420	11300	4620	3870	5750	10200	9420	11300
355	9410	8950	9700	9410	3870	2910	5330	14600	13600	16100	3780	2910	5330	14600	13600	16100

6 pole (1000 min⁻¹)

71	100	360	320	450	80	80	80	380	330	470	340	300	430	120	120	120
80	140	630	550	770	110	110	110	660	570	810	590	500	740	170	170	170
90	160	680	580	810	110	110	110	710	610	870	620	520	770	210	210	210
100	220	940	800	1100	140	140	140	1000	850	1200	840	700	1050	300	300	300
112	220	940	810	1090	120	120	120	1010	880	1220	810	680	1010	320	320	320
132	350	1370	1170	1560	150	150	150	1520	1310	1800	1130	920	1410	550	550	550
160	2470	1840	1450	2040	1780	1370	2190	2120	1720	2530	1360	950	1770	2540	2140	2950
180	2730	2010	1590	2210	1910	1480	2380	2360	1930	2830	1400	960	1860	2880	2450	3340
200	3920	3130	2620	3420	2810	2290	3450	3610	3080	4240	2310	1790	2950	4110	3580	4740
225	4240	3450	2800	3680	2810	2120	3540	4160	3470	4890	2250	1560	2980	4720	4030	5450
250	4750	3940	3220	4210	3060	2320	3920	4780	4030	5630	2530	1780	3390	5310	4570	6170
280	8340	7950	7340	8340	5900	5180	7090	9280	8560	10500	5900	5180	7090	9280	8560	10500
315	9170	8700	8790	9170	5260	4380	6600	12200	11300	13500	5260	4380	6600	12200	11300	13500
355	11100	10600	11300	11100	5220	4090	6940	16600	15400	18300	5220	4090	6940	16600	15400	18300

8 pole (750 min⁻¹)

71	100	420	370	520	80	80	80	440	390	540	400	350	500	120	120	120
80	140	730	630	880	110	110	110	750	650	920	680	590	860	170	170	170
90	160	800	690	950	110	110	110	830	720	1010	740	620	920	210	210	210
100	220	1100	940	1300	140	140	140	1160	1000	1400	1000	840	1240	300	300	300
112	220	1100	940	1270	120	120	120	1170	1020	1400	970	810	1200	320	320	320
132	350	1610	1380	1850	180	180	180	1740	1500	2070	1390	1160	1720	520	520	520
160	2760	2090	1640	2340	2020	1570	2480	2360	1910	2820	1600	1150	2060	2780	2330	3240
180	3040	2290	1820	2520	2130	1640	2650	2680	2190	3200	1610	1130	2130	3200	2710	3720
200	4410	3550	2970	3910	3230	2630	3940	4020	3430	4730	2730	2130	3440	4520	3930	5230
225	4780	3870	3130	4220	3320	2550	4140	4510	3750	5340	2760	1990	3580	5070	4310	5900
250	5290	4440	3640	4750	3430	2600	4390	5340	4500	6300	2900	2060	3860	5880	5040	6840
280	9480	8990	8230	9480	6930	6120	8280	10200	9390	11600	6930	6120	8280	10200	9400	11600
315	10400	9880	9790	10400	6350	5360	7860	13300	12300	14800	6350	5360	7860	13300	12300	14800
355	12700	12100	12600	12700	6580	5310	8510	17900	16600	19800	6580	5310	8510	17900	16600	19800

* Please consult us for the values.

Permissible external axial loads

Reinforced design with cylindrical roller bearing

Frame size	Horizontal Shaft				Vertical Shaft											
	Tensile	Thrust			Shaft down						Shaft up					
		Without F_r		With max. F_r at		Force down			Force up			Force down			Force up	
	X_o	X_{max}	F_r	F_r	X_o	X_{max}	F_r	X_o	X_{max}	F_r	X_o	X_{max}	F_r	X_o	X_{max}	F_r
	N	N	N	N	N	N	N	N	N	N	N	N	N	N	N	N

2 pole (3000 min⁻¹)

160	2450	2040	1440	2450	1740	1140	2270	2220	1620	2750	1740	1140	2270	2220	1620	2750
180	2820	2400	1780	2820	1750	1330	2550	2680	2050	3280	1950	1330	2550	2680	2050	3280
200	3710	3160	2380	3710	2570	1790	3350	3520	2730	4290	2570	1790	3350	3520	2730	4290
225	4150	3480	2590	4150	2770	1870	3720	3920	3020	4870	2770	1870	3720	3920	3020	4870
250	5000	4150	2880	5000	3200	1920	4410	4750	3460	5960	3200	1920	4410	4750	3460	5960
280	5180	4080	2950	4650	3230	2090	4330	4940	3790	6040	2700	1550	3800	5470	4330	6570
315	3340	3380	2940	3340	930	190	1660	5330	4600	6060	930	190	1660	5330	4600	6060
355	3010	3020	3320	3010	*	*	*	6640	5890	7310	*	*	*	6640	5890	7310

4 pole (1500 min⁻¹)

160	3240	2720	1940	3240	2320	1540	3010	2950	2160	3640	2320	1540	3010	2950	2160	3640
180	3760	3200	2390	3760	2650	1830	3440	3530	2710	4310	2650	1830	3440	3530	2710	4310
200	4950	4200	3180	4950	3530	2500	4550	4610	3580	5630	3530	2500	4550	4610	3580	5630
225	5520	4650	3250	5520	3710	2300	4960	5210	3800	6460	3710	2300	4960	5210	3800	6460
250	6640	5540	3880	6640	4340	2660	5930	6270	4600	7860	4340	2660	5930	6270	4600	7860
280	7100	6200	4630	7100	4440	3130	6040	7270	5960	8870	4440	3130	6040	7270	5960	8870
315	7840	7340	5220	7840	3910	1770	5750	9460	7320	11300	3910	1770	5750	9460	7320	11300
355	9410	9540	7920	9410	3280	1200	5330	14000	11900	16100	3280	1200	5330	14000	11900	16100

6 pole (1000 min⁻¹)

160	3840	3240	2320	3840	2760	1830	3570	3520	2600	4330	2760	1830	3570	3520	2600	4330
180	4460	3790	2850	4460	3180	2230	4100	4150	3190	5070	3180	2230	4100	4150	3190	5070
200	5820	4960	3780	5820	4150	2950	5340	5450	4250	6640	4150	2950	5340	5450	4250	6640
225	6500	5530	3900	6500	4330	2680	5800	6240	4590	7710	4330	2680	5800	6240	4590	7710
250	7860	6580	4640	7860	5170	3210	7030	7420	5460	9280	5170	3210	7030	7420	5460	9280
280	8390	7320	5460	8390	5370	3490	7230	8490	6610	10400	5370	3490	7230	8490	6610	10400
315	9170	8740	6270	9170	4440	1920	6600	11300	8830	13500	4440	1920	6600	11300	8830	13500
355	11100	11300	9300	11100	4540	2110	6940	15900	13400	18300	4540	2110	6940	15900	13400	18300

8 pole (750 min⁻¹)

160	4340	3640	2620	4340	3150	2130	4060	3910	2890	4820	3150	2130	4060	3910	2890	4820
180	5010	4270	3210	5010	3590	2530	4620	4660	3590	5690	3590	2530	4620	4660	3590	5690
200	6580	5590	4260	6580	4770	3430	6110	6070	4730	7410	4770	3430	6110	6070	4730	7410
225	7360	6180	4370	7360	5080	3240	6720	6830	4990	8480	5080	3240	6720	6830	4990	8480
250	8800	7370	5220	8800	5830	3660	7910	8270	6100	10400	5830	3660	7910	8270	6100	10400
280	9510	8210	6140	9510	6310	4210	8400	9340	7240	11500	6310	4210	8400	9340	7240	11500
315	10400	9760	7000	10400	5440	2630	7860	12300	9540	14800	5440	2630	7860	12300	9540	14800
355	12700	12800	10300	12700	5830	3120	8510	17200	14400	19800	5830	3120	8510	17200	14400	19800

* Please consult us for the values.

Notes: • 1Newton (N) = $\frac{1}{9.81}$ kgf \approx 0.1 kgf

- All above values are :
 - based on L₁₀ bearing life of minimum 20 000 hours.
 - for 50 Hz.
- Please inquire for :
 - 60 Hz.
 - multi-speed motors.

Shaft extensions

The motors of standard design are built with one cylindrical shaft extension with shaft-key fitted in accordance to IEC 60 072-1. Motors with double shaft extension may be delivered on special orders. The free shaft-ends have threaded centre-bore to DIN 322 form D.

The run-out of the shaft, concentricity of mounting spigot and the perpendicularity of the face flange are within the permissible limits (Normal class) according to IEC 60 072-1. Motors with increased accuracy (Precision class) may be supplied on request.

Vibration

Shaft/rotor assemblies of our standard range motors are, dynamically balanced with Half Shaft Key to the limits of normal mechanical vibration class quoted by DIN ISO 2373, shaft fitments such as couplings, pulleys, gears and fans must also be balanced likewise to prevent undue vibration and adverse effects on bearing life.

Noise level

The international limits of noise produced by general purpose electric motors are defined in IEC 60 034-9, with which our standard range of motors comply. There are 3 main sources of noise :

1. Magnetic forces which tend the stator core radial oscillations.
2. Bearings which generate noise due to imperfections in the geometry of the balls and rollers.
3. Cooling fan which generates so called ventilation noise.

Among these 3 main sources of noise, the ventilation noise is the most dominating factor especially on large motors. Special measures for further noise limitation can be taken on request.

Air-borne sound measurements are performed in a deadened sound testing chamber (reflection free room) according to EN 21 680 Part 1.

The measuring surface sound pressure level ($L_{p(A)}$) in dB(A) is the mean value of the A-weighted sound pressure level measured in several places on a measuring surface at a distance of 1 m from the contour of the machine. Tolerance +3 dB(A).

Following values are for 50 Hz supply. Values will increase by approximately 4dB(A) for 60 Hz supply.

Measuring - surface sound pressure level ($L_{p(A)}$)

Frame size	2 Pole dB(A)	4 Pole dB(A)	6 Pole dB(A)	8 Pole dB(A)
56	42	42	—	—
63	52	43	—	—
71	50	44	42	40
80	54	46	43	43
90	61	46	46	45
100	62	50	50	48
112	63	52	55	53
132	66	54	61	56
160	70	63	62	61
180	70	64	62	61
200	73	64	61	62
225	73	64	62	63
250	76	67	64	64
280	76	67	65	65
315	79	74	72	70
355	79	75	72	70

Painting



Standard range and (EFF2) motors are painted in grey according to RAL 7031 (DIN 1843) and (EFF1) motors are painted in blue according to RAL 5007 (DIN 1843) with a protective paint. Special external coatings for protection against excessive corrosive atmospheres, chemicals and microorganism are available on request.

Storage

Motors must be kept in a dry and vibration-free place if they have to be stored for a long period. The insulation resistance must be checked and the windings must be dried if necessary, before the motors are taken into operation.

Type of construction and mounting arrangement (DIN IEC 60 034-7)

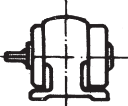
Foot mounted

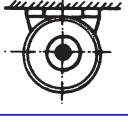
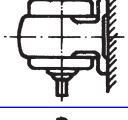
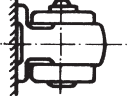
Figure	Designation	Description
	B 3 IM 1001	On substructure.
	B 6 IM 1051	On wall. Feet to the left viewing from D-End
	B 7 IM 1061	On wall. Feet to the right viewing from D-End.
	B 8 IM 1071	On ceiling.
	V 5 IM 1011	On wall. Shaft extension downwards.
	V 6 IM 1031	On wall. Shaft extension upwards.

Flange mounted (Without foot)

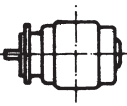
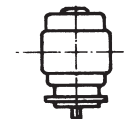
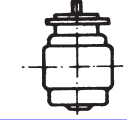
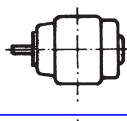
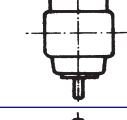
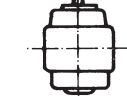
Figure	Designation	Description
	B 5 IM 3001	D-End D-Flange form A.
	V 1 IM 3011	D-End D-Flange form A. Shaft extension downwards.
	V 3 IM 3031	D-End D-Flange form A. Shaft extension upwards.
	B 14 IM 3601	D-End C-Face Flange form C.
	V 18 IM 3611	D-End C-Face Flange form C. Shaft extension downwards.
	V 19 IM 3631	D-End C-Face Flange form C. Shaft extension upwards.

Foot and flange mounted

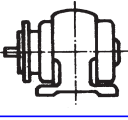
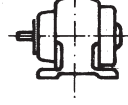
	B 35 IM 2001	D-End D-Flange form A.
	B 34 IM 2101	D-End C-Face Flange form C.

Without foot / Endshield at D-End

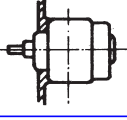
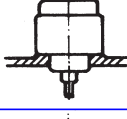
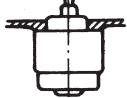
	B 9 IM 9101	Frame Face mounting.
	V 8 IM 9111	Frame Face mounting. Shaft extension downwards.
	V 9 IM 9131	Frame Face mounting. Shaft extension upwards.

Foot mounted / Without endshield at D-End

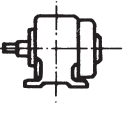
	B 15 IM 1201	On substructure Frame Face mounting.
---	-----------------	---

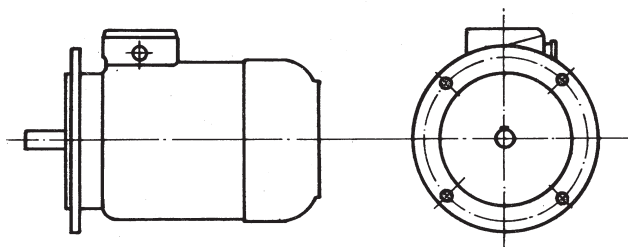

Motor with D-Flange form A (DIN 42 948)

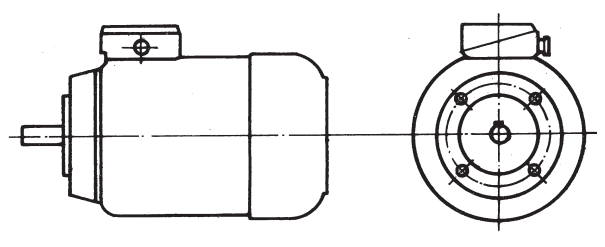

Motor with C-Flange form C (DIN 42 948)

ELECTRICAL DESIGN

Voltage and frequency

Motors are normally wound for a rated supply of 400 Volt and frequency 50 Hz. However, motors for any standard supply from 110 to 660 V at frequencies of 50/60 Hz may be supplied on request.

Motors will operate satisfactorily with a voltage band of $\pm 10\%$ of the rated voltage. In case of continuous operation at the extreme voltage limits specified above, the temperature rise limits permitted for various insulation classes may be exceeded by 10 K maximum.

Motors wound for 50 Hz may generally be connected to 60 Hz supply. In this case the speed will increase by 20% with reference to various rated voltages at 50 Hz, the approximative multipliers to obtain the new performance values at 60 Hz are given in the following table.

50 Hz	60 Hz								
Rated voltage V	Supply voltage V	New performance data at full load							
		Output	Speed	I_N	M_N	I_A/I_N	M_A/M_N	M_K/M_N	I_0
220	220	1	1.2	1	0.83	0.87	0.75	0.85	0.73
	*220	1.15	1.2	1.15	0.96	0.98	1	1.12	1.12
	255	1.15	1.2	1	0.96	1	0.93	1	0.93
380	380	1	1.2	1	0.83	0.87	0.75	0.85	0.73
	*380	1.15	1.2	1.15	0.96	0.98	0.93	1	1.12
	415	1.1	1.2	1	0.91	0.96	0.83	0.94	0.85
	440	1.15	1.2	1	0.96	1	0.93	1	0.93
	460	1.2	1.2	1	1	1.03	0.98	1.03	0.98
415	415	1	1.2	1	0.83	0.87	0.75	0.85	0.73
	*415	1.15	1.2	1.15	0.96	0.98	0.93	1	1.12
	460	1.1	1.2	1	0.92	0.98	0.90	0.96	0.87
	480	1.15	1.2	1	0.96	1	0.93	1	0.93
500	500	1	1.2	1	0.83	0.87	0.75	0.85	0.73
	*500	1.15	1.2	1.15	0.96	0.98	0.93	1	1.12
	550	1.1	1.2	1	0.92	0.98	0.90	0.96	0.87
	575	1.15	1.2	1	0.96	1	0.93	1	0.93
	600	1.2	1.2	1	1	1.03	0.98	1.03	0.98

* Special winding

Rated output

The rated output P_N is the mechanical power in Watts available at the shaft, and it is specified on the motor name-plate. The active power P_1 is the power in Watts transmitted from the supply to the motor, and it is always bigger than the mechanical power due to losses.

$$P_1 (W) = \sqrt{3} \cdot U \cdot I \cdot \cos \varphi$$

Efficiency is the ratio of the mechanical power to the active power. The efficiency values given at ratings and performance tables are calculated by the method of summation of losses.

The rated outputs tabulated in this catalogue expressed in kW, refer to the mechanical power where motor is running continuously (S1) at rated load, voltage, frequency, at ambient temperature not exceeding $+40^\circ\text{C}$ and an altitude of installation up to 1000 m above sea-level.

Environmental conditions

If standard range F class insulated **GAMAK** motors are operated at an ambient temperature beyond 40°C and altitude over 1000 m above sea level, their rated outputs will change at the ratios given below.

Ambient temp.	$^\circ\text{C}$	< 30	30..40	45	50	55	60
Rated output	%	107	100	95	90	85	80

Altitude	m	1000	2000	3000	4000
Rated output	%	100	95	90	80

If ambient temperature and altitude both vary, multiply the rated output with its respective factors to obtain the new permitted output. If the output reduction exceeds 15%, please consult us as the operating characteristics of the motor will become unfavourable due to its low utilization factor.

At altitudes over 1000 m, the rated output of a motor will remain unchanged if the ambient temperature of 35°C drops by 1.0°C for insulation class F, 1.25°C for insulation class H for every 100 m increment of altitude.

Over-load capacity

No harmful temperature rise will occur, if an excess current of 1.5 times the rated current is applied for 2 min, at intervals of minimum 15 min, to a motor running at thermal equilibrium.

Motors are also capable of withstanding for 15 sec. to a momentary gradually increasing excess torque of 1.6 times their rated torque, when they are running at their rated voltage and frequency.

The size of overloads for longer periods than specified above depends on the size of motor, temperature rise characteristics of motor, period/frequency of overload, and whether overloads take place upon starting when the motor is running cold or at its thermal equilibrium.

Rated torque

The torque transmitted to the motor shaft is :

$$\text{Rated torque (Nm)} = 9550 \frac{\text{Rated output (kW)}}{\text{Rated speed (rpm)}}$$

$$1 \text{ kgf m} = 9.81 \text{ Nm} \approx 10 \text{ Nm}$$

The load-torque of a motor during acceleration must always be bigger than the opposing torque of the driven machine.

Insulation class

The insulation class of our standard range motors is "F".

Although the permitted limit of temperature rise for Insulation Class "F" is 105 K by resistance method, the motors are designed to operate within class "B" limit (80 K) which gives longer life and reliability. Furthermore, this gives the ability to withstand ambient temperatures as high as 60°C (upto size 160) and 55°C (size 180 and upwards), or alternatively to overloads upto 15% and 10% respectively, or adverse electrical supply conditions.

Motors of superior Insulation Class H (125 K) may be supplied on request.

The enamelled round copper winding wire used in our standard range of motors are double enamelled (2L) with polyesterimide as base coat (Thermal Class "H" 180°C) plus polyamideimide as top coat. (Thermal class "C" 200°C) IEC 60 317-13.

The windings are impregnated by dipping in class F synthetic resin (polyester) and then they are thoroughly baked to ensure a high resistance to vibrations and a better heat transfer. The winding insulation of standard production is tropic proof and can thus be used at normal climatic conditions as well as moderately damp locations, and is resistant against aggressive gases, vapour and oils. As an option, motors with increased winding insulation resistant against relative humidity of 95% can be supplied.

General Information on Frequency Converter Fed A.C. Cage Induction Motors

The static frequency converters is an electronic unit for infinite speed control of A.C. motors by providing a power supply of variable frequency and voltage simultaneously. A full stepless variable speed is obtained when an A.C. cage induction motor is fed by a suitably designed converter.

Frequency converters are grouped according to the switching pattern controlling the motor supply. The commonly used type so called PWM converter has a constant intermediate D.C. voltage and Pulse Width Modulated output voltage. Another type with intermediate D.C. voltage is the PAM (Pulse Amplitude Modulation) converter.

Speed Control of A.C. Cage Induction Motors

Today, the frequency converter controlled A.C. cage induction motors are used for all kinds of automated plant and equipment. The infinite speed control of A.C. motors gives the advantages of energy saving, process and quality improvements.

Extensive calculations and measurements show that the best operating characteristics can be obtained with 4 pole A.C. cage induction motors for all common speed ranges, therefore, this number of pole is preferred for variable-speed motors. For applications with very low or high speeds, different numbers of pole might also be considered. The rated voltage of the motor is usually chosen as the mains supply voltage in order to allow the motor to run directly from the mains supply in the event of frequency converter failure.

Standard motors are generally used with frequency converter, in any case for the lower power ranges. There are different systems depending on the power range involved and other requirements. A common feature of all systems is that there are additional losses in the motor caused by inverter output voltages and currents which are effected by harmonic components, as the voltage is not fully sinusoidal. Hence the motor cannot provide its rated output. The type of motor and converter being used should be well chosen according to the magnitude of these extra losses. Usual practice is to derate the output of the motor by 0-20% at rated speed to compensate for the increase in losses. To determine the derating factor, the thermal reserve of a particular motor has to be considered. (IEC 60 034-17 application guide for cage induction motors when fed from converters).

Due to the very high rate of voltage rise and the possibility of transient voltages at the motor terminals, the insulation system of inverter-fed induction motors may be subject to greater stress than that of mains-operated motors. Apart from the leakage reactance of the motor, this additional stress mainly depends on the frequency converter used and the cable length between the frequency converter and motor. Consequently it may be necessary to consider cable length, filter requirement and in some cases the consideration of special insulation systems. Peak voltages and rates of voltage rise exceeding the values given in IEC 60 034-17 can be accepted only if agreed with the motor manufacturer.

The double cage or deep-bar rotor design should be avoided particularly on large motors due to high harmonic losses. It may be preferable to use different rotor configurations as there is no need of a high starting from the mains in the case of emergencies particularly with constant torque drives.

A motor fed by a converter may run noisier than a standard main supply fed motor due to harmonics. This can be reduced by suitable motor and converter design.

The frequency converter output voltage waveform interacts with the stray impedances of the motor and cables to induce voltages into the motor shaft. If these voltages are sufficient, damaging currents may flow in unintended circuits through the bearings, resulting in premature failure. Failure due to bearing currents is seldom encountered, but for security of operation in large motors, insulated non-drive-end bearing assembly may be foreseen.

Reducing the speed of an A.C. Cage Induction Motor below its rated speed

The motor can be loaded at constant torque when the frequency is reduced and the primary voltage is changed in proportion to the frequency. Both current and power-factor will remain unchanged if the torque is kept constant. However, at low frequency, if the same maximum torque is to be maintained, the voltage should also be slightly more than proportional to the frequency, in order to compensate for the voltage drop in the stator.

For variable torque loads when the torque reduces with decreasing speed such as with centrifugal pumps and fans, it is better to choose a converter so that the voltage decreases more than the frequency.

At low speeds, the motor fan cannot supply sufficient amount of cooling air when the load torque is constant across the speed range. The dissipation of heat from the motor is poorer and is only partly offset by the decrease in iron losses. For self ventilated motors with a wide speed range, it may be necessary to derate the motor output or alternatively use forced ventilation.

Increasing the speed of an A.C. Cage Induction Motor above its rated speed

As the frequency converter cannot supply a voltage that is higher than the voltage from the mains supply, the magnetic field is weakened due to the reduction of voltage-frequency ratio. This in turn results in the motor to yield a reduced torque above its rated speed and will only supply constant power, so the I^2R losses are about constant and the iron losses may reduce. Depending on the breakdown torque at the rated operation, the motor should continue to operate at constant output upto a speed where the power starts to reduce. At higher frequencies, due to severe field weakening, the increased slip increases the I^2R losses. Additionally, skin effect can start having a detrimental effect. However, the losses are not the main problem.

Although the losses at high speed limit motor operation to a constant power characteristic above the base speed, maximum speed limit is determined by :

- Breakdown torque.
- Bearing capability: The bearings will be subjected to more mechanical stress due to greater vibration above the rated speeds which will reduce the life of the bearings and the grease. In such case, it is necessary to specify the balancing of the rotors to be the vibration severity grade S - Special (DIN EN 60 034-14).
- Fan design: The fan should be mechanically strong enough to withstand the centrifugal forces. It is usual to consider a shaft mounted fan only upto say 60 Hz. Furthermore, increased fan noise may occur in self ventilated motors. Thus, as an alternative the use of a forced ventilation needs to be considered.

Duty types

Duty is a statement of the loads to which the machine is subjected, including starting, electric braking, no-load and rest and de-energized periods, and also their durations and sequence in time.

However, duty type is a continuous, short-time or periodic duty, comprised of one or more loads remaining constant for the duration specified, or a non-periodic duty in which generally, load and speed vary within the permissible operating range.

Electric motors are manufactured as adaptable to various operating conditions. Standard duty types are classified by IEC 60 034-1 :

S1 : Continuous running duty.

Operation at constant load of sufficient duration for thermal equilibrium to be reached.

S2 : Short-time duty.

Operation at constant load for a duration that is shorter than the time required to reach thermal equilibrium. After each operation period, the motor has to be de-energized for a sufficient duration until the windings are cooled to ambient temperature. Operation period at constant load can be recommended as 10, 30, 60 and 90 mins.

S3 : Intermittent periodic duty.

A sequence of identical duty cycles, each including a period of operation at constant load and a rest and de-energized period. In this type of duty, the cycle is such that the starting current does not significantly effect the temperature rise. Duty cycle is 10 min. unless otherwise agreed. Cyclic duration factor of 15%, 25%, 40% and 60% may be considered.

S4 : Intermittent periodic duty with starting.

A sequence of identical duty cycles, each cycle including a significant period of starting, a period of operation at constant load and a rest and de-energized period. In this type of duty the starting current has no significant effect on the temperature rise. The duty cycles are too short for thermal equilibrium. Starting load-torque (N), number of starts per hour, cyclic duration factor and factor of inertia (FI) have to be given.

S5 : Intermittent periodic duty with electric braking.

A sequence of identical duty cycles, where each cycle consists of a period of starting, a period of operation at constant load, followed by rapid electric braking and a rest and de-energized period. Starting and brakings have influence on temperature rise of windings. Starting/braking load-torque (N), number of starting and brakings per hour, cyclic duration factor and factor of inertia (FI) have to be given.

S6 : Continuous-operation periodic duty.

A sequence of identical duty cycles, where each cycle consists of a period of operation at constant load and a period of operation at no-load. There is no rest and de-energized period. The duty cycles are too short for thermal equilibrium to be reached. Duty cycle is 10 m in unless otherwise agreed. Cyclic duration factor of 15%, 25%, 40% and 60% may be considered.

S7 : Continuous-operation periodic duty with electric braking.

A sequence of identical duty cycles, where each cycle consists of a period of starting, a period of operation at constant load and a period of electric braking. There is no rest and de-energized period. The duty cycles are too short for thermal equilibrium to be reached. Load and factor of inertia (FI) at the operating period have to be given.

S8 : Continuous-operation periodic duty with related load/speed changes.

A sequence of identical duty cycles, each cycle consisting of a period of operation at constant load corresponding to a predetermined speed of rotation, followed by one or more periods of operation at other constant loads corresponding to different speeds of rotation. There is no rest and de-energized period. Load, cyclic duration factor and factor of inertia (FI) for each speed at the operating period have to be given.

S9 : Duty with non-periodic load and speed variations.

A duty in which generally load and speed are varying non-periodically within the permissible operating range.

This duty includes frequently applied overloads that may greatly exceed the full loads. Load and factor of inertia (FI) for each speed have to be given.

Cyclic duration factor is the ratio of the period of loading, including starting and electrical braking, to the duration of the duty cycle and is expressed as a percentage.

$$\text{Factor of inertia (FI)} = \frac{J_M / J_Z}{J_M}$$

J_M : Moment of inertia of the motor (kgm²).

J_Z : Total moment of inertia of driven machine and parts such as couplings, etc., referred to motor shaft (kgm²).

The nature of braking, whether mechanical or electrical (D.C. or reversed current) has also to be stated.

The ratings and performance data given in this catalogue, are for continuous running at constant load for a sufficient duration to reach thermal equilibrium which correspond to duty type S1.

However, our standard range motors may be operated at all the other duty types, provided that the limit of permissible temperature rise is not exceeded.

Starting frequency

If a cage induction motor is started frequently, the permissible number of starts for a given period of time is limited by the temperature rise of windings during starting. The values of permissible starting frequency per hour at no-load (z_0) are given in the table below for **GAMAK** motors.

The starting frequency per hour under given operating conditions are calculated according to the following formula:

$$z = \frac{J_M}{J_M + J_z} \cdot \frac{M_M - M_L}{M_M} \cdot \left[1 - \left(\frac{P}{P_N} \right)^2 \right] \cdot z_0$$

z : Starting frequency per hour under given operating conditions.

z_0 : Starting frequency per hour at no-load (given in the table).

J_M : Moment of inertia of motor (kgm^2).

J_z : Total moment of inertia of driven machine and parts such as couplings, etc., referred to motor shaft (kgm^2).

M_M : Mean torque value of motor during acceleration (Nm).

M_L : Mean torque value of driven machine during acceleration (Nm).

P_N : Rated motor output (kW).

P : Required load power (kW).

An induction motor is not allowed to be loaded at its rated output P_N , if it starts and stops frequently. The permissible motor power P is smaller than the rated output P_N and is calculated according to the following formula:

$$P = P_N \bullet \left(1 - \frac{z}{z_0} \cdot \frac{J_M + J_z}{J_M} \cdot \frac{M_M}{M_M - M_L} \right)$$

For **GAMAK** motors, M_M may be taken as approximately twice the rated motor torque.

An electrical reversal sets up approximately 3.5 to 4 times the starting heat, this means that an electric reversal equals about 4 startings. Therefore, the starting frequency may be divided by 4 to obtain the reversal frequency. However when calculating reversal frequency, the load torque M_L should not be taken into consideration.

Permissible starting frequency per hour at no-load (z_0)

Frame size	Motor speed (min^{-1})			
	3000	1500	1000	750
* 56	12200	21000	—	—
63	31000	49000	—	—
71	15700	21700	32000	35000
80	9800	18500	29000	33000
90	S	9400	17500	26600
	L	9100	16800	24500
100	L	6600	11200	14000
112	M	3500	9400	13000
132	S	2200	5100	10000
	M	—	4900	8000
160	M	1100	3100	4200
	L	1050	3000	3700
180	M	700	2200	—
	L	—	2100	3500
200	L	520	2000	3200
225	S	—	1900	—
	M	450	1800	2300
250	M	350	1000	1900
280	S	230	740	1500
	M	210	700	1200
315	S	140	460	840
	M	120	420	700
	L	100	370	600
355	M	60	180	300
	L	50	160	250

* Without cooling fan (IC 410, DIN IEC 60 034-6).

Starting time

To start an induction motor safely, the load torque produced during acceleration must be bigger than the load-torque of the driven machine at every speed value. Especially the starting torque of the motors has to be bigger than the load-torque of the driven machine at rest. For drives requiring high load-torque during acceleration, special rotors may be designed to increase starting torque of motors.

Starting time is an important factor of an electric motor regarding its operating behaviour. As each start increases the temperature of motor windings, the starting time and starting frequency have to be limited to avoid any possible damage.

Calculation of starting time is rather complicated but the following formula may be applied as a first approximative.

$$t_a = \frac{(J_M + J_Z) \cdot n}{9.55 \cdot (M_M - M_L)}$$

t_a : Starting time (s)

J_M : Moment of inertia of motor (kgm²)

J_Z : Total moment of inertia of the driven machine and parts such as couplings, etc., referred to motor shaft (kgm²)

n : Full-load speed of motor (rpm)

M_M : Mean torque of motor during acceleration (Nm)

M_L : Mean torque of driven machine during acceleration (Nm)

There is no danger in starting up a motor in relation to temperature rise if the starting time obtained by this calculation is less than the value given at the below table for **GAMAK** motors. The permissible starting time depends on whether the motor starts in a cold or thermal equilibrium condition. However, in case the calculated starting time exceeds the permissible value below, either precautions to provide an easier start should be taken, or a more favourable motor having higher starting performance may be preferred.

Generally speaking, a cage-rotor induction motor can consecutively be started 3 times in cold condition and twice at thermal equilibrium at drives where the load-torque rises with the square of speed and its moment of inertia is not excessively high. The motor should be rested (approx. 30 min.) until it has cooled down before re-starting.

Permissible starting time (s) at direct-on-line starting

Frame size	Motor speed (min ⁻¹)							
	3000		1500		1000		750	
	In cold condition	At thermal equilibrium	In cold condition	At thermal equilibrium	In cold condition	At thermal equilibrium	In cold condition	At thermal equilibrium
56	90	35	180	75	—	—	—	—
63	70	28	100	45	—	—	—	—
71	50	20	75	30	140	55	140	55
80	40	15	60	25	90	35	90	35
90	35	13	50	20	65	25	65	25
100	32	12	40	17	50	20	50	20
112	30	11	35	14	40	16	40	16
132	28	10	30	12	32	13	32	13
160	26	9	27	10	28	10	28	10
180	24	8	25	9	25	9	25	9
200	22	8	23	8	23	9	23	9
225	20	7	21	8	22	8	22	8
250	19	7	20	7	21	8	21	8
280	18	6	19	7	20	7	20	7
315	18	6	18	6	19	7	19	7
355	16	5	16	5	17	6	17	6

Y / Δ Starting time is three times the above given direct-on-line starting values.

Terminal connections and starting of motors

Terminal connections and methods of starting of our standard range motors

Number of poles	Output ranges in kW at the rated voltage 400V, 50 Hz (Eurovolt)	
	220-240 V (Δ) / 380-415 V (Y)	380-415 V (Δ)
2 and 4	3 kW and below.	4 kW and above.
6	2.2 kW and below.	3 kW and above.
8	1.5 kW and below.	2.2 kW and above.
Methods of starting	Direct-on-line	Direct-on-line Y / Δ or others

Terminal connections other than above, can be provided upon request

Direct-on-line starting

The simplest way to start a cage induction motor is to connect the mains supply to the motor directly. The only starting equipment required is a direct-on-line starter.

Star/Delta (Y/ Δ) Starting

If the starting current of the motor is higher than the limit of the power supply, a star/delta starter can be used. A motor wound 380 or 400V (Delta) is started with the winding (Star) connected. This method reduces the starting current and torque to about 1/3 of the value for direct-on-line starting. In order to limit current and torque surges during switch-over from Star to Delta, switch-over should not be carried out until the motor reaches at least 90% of its rated speed.

Soft starting

On occasion some motors need to be started smoothly where the starting current is not so important, a suitable soft-starter may be used. A soft-starter permits the starting time to be set for a smooth start and the operation of motor to be monitored continuously so that the voltage can be adjusted according to the demand, which minimise the losses. However, the torque characteristic of the motor must conform to the requirements of the driven machine, when a soft-starter is used.

Auto-transformer Starting

Auto-transformers can be used to reduce starting current and torque by a ratio other than 1/3, which is fixed with Star/Delta starting. If insufficient acceleration torque is produced with a Star/Delta start, a suitable compromise may be reached using an auto-transformer, the supply side current and motor torque are reduced by the square of transformer turns ratio. For example, if the transformer has a 70% tapping, the torque is reduced to 0.70^2 (49%) of the DOL value. The motor current is reduced to 70% of its DOL value, but the supply side of the transformer only "sees" 70% of this current due to the transformer turns ratio. Thus the supply current is also reduced to 49% of its DOL value.

A Korndorfer arrangement on the transformer can eliminate the surge experienced during switching from the lower starting voltage to the rated voltage.

Electric protection of motors

The thermal protection of the stator windings should be chosen as an optimum in respect of the operating conditions. Apart from the use of circuit-breakers with thermally delayed (bi-metal release) over-current protection, motors can also be thermally protected against over-loads by means of thermistors (semiconductor temperature sensors) or thermostats (bi-metal switches) embedded in the winding. Thermal motor protection provides a higher degree of protection because the temperature is controlled in the winding which is the most critical point and independent of outside influences or type of duty etc.

Tolerances (IEC 60 034-1)

— Efficiency (by summation of losses)		
Motor up to 50 kW	: P ≤ 50 kW	- 0.15 (1 - η)
Motors above 50 kW	: P > 50 kW	- 0.10 (1 - η)
— Power factor (cos φ)	- $\frac{1 - \cos \varphi}{6}$	minimum 0.02 maximum 0.07
— Slip (At full-load and working temperature)		± 20 % of the guaranteed slip
— Locked-rotor current		+ 20 % of the guaranteed starting current (No lower limit)
— Locked-rotor torque		- 15 %, + 25 % of the guaranteed torque (+ 25 % may be exceeded by agreement)
— Pull-up torque (Not quoted in VDE 0530)		- 15 % of the guaranteed torque
— Breakdown torque		- 10 % of the guaranteed torque except that after allowing for this tolerance, the torque shall be not less than 1.6 times the rated torque.
— Moment of inertia		± 10 % of the guaranteed value
— Noise-level (Mean sound pressure level)		+ 3 dB (A)

Information required when ordering motors

When inquiring or ordering, the following particulars are requested to be specified :

- Quantity
- Type of motor
- Rated output (kW)
- Rated voltage/frequency and terminal connection
- Speed (min⁻¹)
- Type of construction and mounting arrangement
- Enclosure-degree of protection
- Insulation class
- Ambient conditions (Temperature, relative humidity, altitude, etc.)
- Type of duty
- Type and specifications of machine to be driven
- Miscellaneous

Efficiency and power factor

(Used in conjunction with detailed performance data on pages 21 to 25 inclusive)

% Efficiency (η) at					Power factor (Cos ϕ) at				
1 / 4	1 / 2	3 / 4	4 / 4	5 / 4	1 / 4	1 / 2	3 / 4	4 / 4	5 / 4
of rated output					of rated output				
92	94.5	96	96	95.5	0.70	0.86	0.91	0.92	0.93
90	93.5	95	95	94.5	0.65	0.84	0.90	0.91	0.92
89	92.5	94	94	93.5	0.63	0.83	0.89	0.90	0.91
88	91.5	93	93	92.5	0.61	0.80	0.88	0.89	0.90
87	91	92	92	91.5	0.57	0.78	0.86	0.88	0.89
86	90	91	91	90	0.53	0.76	0.85	0.87	0.87
85	89	90	90	89	0.51	0.75	0.84	0.86	0.86
84	88	89	89	88	0.49	0.73	0.83	0.85	0.86
80	87	88	88	87	0.47	0.71	0.81	0.84	0.85
79	86	87	87	86	0.45	0.69	0.80	0.83	0.84
78	85	86	86	85	0.43	0.67	0.79	0.82	0.83
76	84	85	85	83	0.41	0.66	0.77	0.81	0.82
74	83	84	84	82	0.40	0.65	0.76	0.80	0.81
72	82	83	83	81	0.38	0.63	0.75	0.79	0.80
70	81	82	82	80	0.36	0.61	0.74	0.78	0.80
68	80	81	81	79	0.34	0.59	0.72	0.77	0.79
66	79	80	80	78	0.32	0.58	0.71	0.76	0.78
64	77	79	79	77	0.30	0.56	0.69	0.75	0.78
62	75	78	78	76	0.29	0.55	0.68	0.74	0.77
60	74	77	77	75	0.28	0.54	0.67	0.73	0.76
58	73	76	76	74	0.27	0.52	0.63	0.72	0.76
56	72	75	75	73	0.26	0.50	0.62	0.71	0.76
55	71	74	74	72	0.25	0.49	0.61	0.70	0.75
54	70	73	73	71	0.24	0.48	0.59	0.69	0.74
53	68	72	72	70	0.23	0.47	0.58	0.68	0.74
52	67	71	71	69	0.23	0.46	0.57	0.67	0.73
51	66	70	70	68	0.22	0.45	0.56	0.66	0.72
50	65	69	69	67	0.22	0.44	0.55	0.65	0.71
49	64	68	68	66	0.22	0.43	0.54	0.64	0.70

• The above given values are averages. The exact values for a specific motor may be supplied upon request.



"HIGH EFFICIENCY" MOTORS TO CEMEP
 3-phase, 400 V, 50 Hz. (Eurovolt)
 Duty type : S1 (continuous)
 Degree of protection : IP 55 (TEFV)
 Insulation class : F (105K)
 Temp. Rise : Class B (80K)

RATINGS AND PERFORMANCE

Speed, Power Factor, Efficiency, Locked-rotor current and Torque values are quoted at 400V, 50 Hz

Rated output kW	Type	Full-load data								Starting data				Breakdown torque ratio M _k /M _N	Moment of inertia J kgm ²	Weight approx. B3 kg
		Speed n min ⁻¹	Current I _N A			Torque M _N Nm	Power Factor Cos φ	Efficiency η %		Locked-rotor current ratio I _A /I _N		Locked-rotor torque ratio M _A /M _N				
			At 380V	At 400V	At 415V			At 4/4	At 3/4	D.O.L.	Y/Δ	D.O.L.	Y/Δ			

2 pole, 3000 min⁻¹

1.1	AGME 80 2b	2900	2.34	2.31	2.32	3.6	0.82	84.0	83.9	6.2	-	2.7	-	3.3	0.0008	10.4
1.5	AGME 90 S 2	2900	3.43	3.42	3.58	4.9	0.74	85.0	85.0	6.3	-	3.1	-	3.7	0.0014	13.5
2.2	AGME 90 L 2	2900	4.55	4.48	4.50	7.2	0.82	86.5	86.5	6.6	-	2.9	-	3.5	0.0017	16
3	AGME 100 L 2	2900	6.1	6.0	5.9	9.9	0.83	87.2	87.2	7.6	-	3.4	-	4.0	0.0031	21
4	AGME 112 M 2	2910	7.7	7.4	7.2	13	0.88	88.5	88.4	7.2	2.3	2.8	0.9	3.5	0.0048	30
5.5	AGME 132 S 2a	2930	11.0	10.7	10.8	18	0.83	89.2	89.2	7.3	2.3	2.8	0.9	3.5	0.0120	39
7.5	AGME 132 S 2b	2910	14.1	13.6	13.3	25	0.89	89.8	89.6	7.2	2.3	3.0	1.0	3.4	0.014	44
11	GME 160 M 2a	2945	20.1	19.5	18.6	36	0.89	91.1	91.0	8.5	2.8	3.4	1.1	3.6	0.034	107
15	GME 160 M 2b	2945	29.7	28.3	27.6	49	0.83	91.7	91.7	7.5	2.4	3.0	1.0	3.5	0.041	115
18.5	GME 160 L 2	2950	33.1	32.3	31.1	60	0.89	92.5	92.6	7.5	2.4	3.1	1.0	3.2	0.051	140
22	GME 180 M 2	2960	40.3	38.3	37.1	71	0.90	92.6	92.5	8.2	2.6	3.0	1.0	3.5	0.075	179
30	GME 200 L 2a	2970	54	52	50	96	0.89	93.2	93.1	8.3	2.7	2.7	0.9	3.0	0.13	240
37	GME 200 L 2b	2970	68	65	63	119	0.88	93.7	93.5	9.1	2.9	3.0	1.0	3.4	0.15	275
45	GME 225 M 2	2975	80	77	75	144	0.90	93.9	93.7	8.7	2.8	2.7	0.9	3.1	0.23	343
55	GME 250 M 2	2980	99	94	91	176	0.90	94.1	93.8	8.7	2.8	2.9	0.9	3.0	0.41	450
75	GME 280 S 2	2980	133	127	124	240	0.90	94.7	94.4	8.0	2.6	2.9	0.9	3.2	0.62	567
90	GME 280 M 2	2980	156	151	144	288	0.91	95.1	94.9	8.5	2.7	2.7	0.9	3.0	0.74	640

4 pole, 1500 min⁻¹

1.1	AGME 90 S 4	1430	2.70	2.60	2.60	7.3	0.73	84.0	84.0	5.5	-	3.0	-	3.3	0.0025	13.7
1.5	AGME 90 L 4	1430	3.60	3.50	3.50	10	0.73	85.0	85.0	5.9	-	3.3	-	3.5	0.0033	17
2.2	AGME 100 L 4a	1435	5.0	5.0	5.0	15	0.74	86.5	86.6	5.9	-	2.9	-	3.4	0.0052	20.8
3	AGME 100 L 4b	1435	6.8	6.6	6.5	20	0.75	87.4	87.6	6.2	-	2.9	-	3.4	0.0068	27.7
4	AGME 112 M 4	1455	8.4	8.2	8.2	26	0.79	88.6	88.7	6.6	2.1	2.5	0.8	3.3	0.012	36
5.5	AGME 132 S 4	1465	11.5	11.2	11.1	36	0.79	89.8	89.0	7.0	2.3	2.8	0.9	3.5	0.026	46
7.5	AGME 132 M 4	1465	15.7	15.4	15.2	49	0.78	90.4	90.6	7.1	2.3	2.7	0.9	3.4	0.032	56
11	GME 160 M 4	1470	22.2	21.0	20.2	71	0.83	91.2	91.3	6.9	2.2	2.8	0.9	3.1	0.072	133
15	GME 160 L 4	1470	30.1	29.3	29.0	97	0.80	92.0	91.9	7.5	2.4	2.6	0.8	3.5	0.092	161
18.5	GME 180 M 4	1475	36.3	34.5	34.0	120	0.84	92.4	92.5	7.7	2.5	3.2	1.0	3.4	0.15	188
22	GME 180 L 4	1475	43.6	42.5	41.8	142	0.81	92.8	92.8	8.3	2.7	3.7	1.2	3.8	0.17	204
30	GME 200 L 4	1475	58	55	53	194	0.85	93.4	93.5	8.0	2.6	3.1	1.0	3.6	0.23	260
37	GME 225 S 4	1475	70	67	66	240	0.85	93.6	93.6	7.2	2.3	3.0	1.0	3.0	0.35	314
45	GME 225 M 4	1475	84	80	79	291	0.86	94.1	94.1	7.3	2.3	3.0	1.0	3.0	0.44	360
55	GME 250 M 4	1480	101	96	91	355	0.88	94.3	94.4	7.6	2.5	3.1	1.0	2.9	0.78	451
75	GME 280 S 4	1485	137	133	131	482	0.86	94.7	94.8	7.9	2.6	2.6	0.8	2.8	1.11	586
90	GME 280 M 4	1485	164	158	152	579	0.87	95.0	95.2	7.4	2.4	2.9	0.9	3.0	1.32	660





3-phase, 400 V, 50 Hz. (Eurovolt)
 Duty type : S1 (continuous)
 Degree of protection : IP 55 (TEFV)
 Insulation class : F (105K)
 Temp. Rise : Class B (80K)

RATING AND PERFORMANCE

Speed, Power Factor, Efficiency, Locked-rotor current and Torque values are quoted at 400V, 50 Hz

Rated output	Type		Full-load data								Starting data				Breakdown torque ratio M_K/M_N	Moment of inertia J	Weight approx. B3
			Speed n	Current I_N			Torque M_N	Power factor Cos ϕ	Efficiency η		Locked-rotor current ratio I_A/I_N		Locked-rotor torque ratio M_A/M_N				
				A					%		D.O.L.	Y/ Δ	D.O.L.	Y/ Δ			
kW	min ⁻¹	At 380V	At 400V	At 415V	Nm	At 4/4	At 3/4	D.O.L.	Y/ Δ	D.O.L.	Y/ Δ	kgm ²	kg				

2 pole, 3000 min⁻¹

0.09	AGM 56	2a	2800	0.26	0.26	0.29	0.31	0.74	65.3	65.0	4.1	-	2.7	-	2.8	0.00011	2.7
0.12	AGM 56	2b	2800	0.39	0.35	0.37	0.41	0.72	66.4	66.0	4.2	-	2.5	-	2.8	0.00012	2.9
0.18	AGM 63	2a	2820	0.50	0.49	0.50	0.61	0.80	66.3	66.0	4.6	-	2.9	-	2.9	0.00011	3.3
0.25	AGM 63	2b	2840	0.65	0.66	0.61	0.85	0.79	69.2	69.0	4.5	-	2.5	-	2.9	0.00013	3.7
0.37	AGM 71	2a	2800	1.10	1.05	1.02	1.26	0.73	67.8	67.5	4.0	-	2.4	-	2.6	0.00026	5.1
0.55	AGM 71	2b	2780	1.30	1.27	1.25	1.90	0.84	73.5	73.2	4.5	-	2.4	-	2.6	0.00034	6.3
0.75	AGM 80	2a	2780	1.90	1.80	1.80	2.60	0.83	71.6	71.3	4.5	-	2.4	-	2.6	0.00053	7.8
1.1	AGM 80	2b	2800	2.50	2.45	2.35	3.80	0.83	78.1	78.0	4.8	-	2.5	-	2.6	0.00066	8.9
1.5	AGM 90	S 2	2800	3.45	3.30	3.30	5.10	0.84	79.2	79.0	4.9	-	2.2	-	2.5	0.0011	11.4
2.2	AGM 90	L 2	2840	4.90	4.65	4.60	7.40	0.84	81.6	81.5	5.2	-	2.5	-	2.6	0.0014	13.8
3	C.AGM 90	L 2	2840	6.50	6.20	6	10	0.84	83.7	83.6	6.1	-	2.8	-	2.9	0.0017	16
3	AGM 100	L 2	2850	6.60	6	6.10	10	0.87	83.2	83.1	6.2	-	2.9	-	3.0	0.0024	17.3
4	C.AGM 100	L 2	2870	8.20	8	7.60	13.3	0.85	84.8	84.7	7.0	2.2	3.0	0.97	3.2	0.0031	21
4	AGM 112	M 2	2850	8.20	7.80	7.70	13.4	0.87	84.8	84.8	5.9	1.9	2.6	0.84	3.0	0.0039	27
5.5	C.AGM 112	M 2	2870	11	10.8	10.6	18.3	0.86	86.1	86.0	6.9	2.2	3.0	0.97	3.2	0.0048	30
5.5	AGM 132	S 2a	2870	11.3	11	10.8	18.4	0.84	85.9	85.8	5.5	1.8	2.5	0.81	2.7	0.0090	33
7.5	AGM 132	S 2b	2890	15.4	14.7	14.3	24.8	0.85	87.6	87.5	5.8	1.9	2.6	0.84	2.9	0.012	39
11	C.AGM 132	M 2	2915	22	21.5	21	36	0.84	89.1	89.2	6.8	2.2	2.8	0.90	2.9	0.018	59
11	GM 160	M 2a	2935	22.4	21.5	21	36	0.84	88.5	88.5	7.2	2.3	2.9	0.94	3.0	0.026	96
15	GM 160	M 2b	2940	28.5	28	27	49	0.86	89.5	89.5	7.6	2.5	2.8	0.90	3.2	0.034	107
18.5	GM 160	L 2	2940	35	34	33	60.4	0.87	90.5	90.5	7.6	2.5	2.8	0.90	2.9	0.041	122
22	C. GM 160	L 2	2930	41	39	38	71.7	0.88	91.3	91.3	7.3	2.4	2.7	0.87	2.8	0.051	140
22	GM 180	M 2	2950	41.5	40	39	71.5	0.88	91.0	91.0	7.6	2.5	2.8	0.90	3.1	0.064	164
30	C. GM 180	L 2	2940	56	54	52	97	0.88	92.2	92.2	7.0	2.3	2.7	0.87	2.8	0.082	190
30	GM 200	L 2a	2940	56	54	52	97	0.88	91.8	91.7	7.2	2.3	2.6	0.84	2.8	0.10	220
37	GM 200	L 2b	2955	68	65	63	120	0.89	92.5	92.5	7.7	2.5	2.6	0.84	2.8	0.13	240
45	C. GM 200	L 2	2960	82	78	76	145	0.90	93.0	93.0	8.0	2.6	2.6	0.84	2.8	0.15	275
45	GM 225	M 2	2960	82	78	76	145	0.90	93.0	93.0	6.9	2.2	2.3	0.74	2.7	0.19	315
55	C. GM 225	M 2	2965	100	95	92	177	0.90	93.3	93.2	7.7	2.5	2.6	0.84	2.9	0.23	343
55	GM 250	M 2	2970	100	95	92	177	0.90	93.3	93.2	6.8	2.2	2.4	0.74	2.5	0.32	390
75	C. GM 250	M 2	2970	134	128	123	241	0.90	93.9	93.9	6.8	2.2	2.2	0.71	2.4	0.41	450
75	GM 280	S 2	2975	136	129	125	241	0.90	93.8	93.8	7.0	2.3	2.3	0.74	2.6	0.50	540
90	GM 280	M 2	2970	161	152	148	289	0.91	94.0	94.0	7.0	2.3	2.6	0.84	2.8	0.62	590
110	C. GM 280	M 2	2975	196	186	180	353	0.91	94.0	94.0	7.3	2.4	2.2	0.71	2.4	0.74	640
110	GM 315	S 2	2980	196	186	180	353	0.91	93.8	93.8	8.3	2.7	1.9	0.61	2.9	1.3	787
132	GM 315	M 2a	2980	235	223	216	423	0.91	93.9	93.9	7.5	2.4	1.9	0.61	2.8	1.5	895
160	GM 315	M 2b	2980	280	266	258	513	0.92	94.4	94.4	7.4	2.4	1.8	0.58	2.5	2.0	1020
185	GM 315	L 2a	2900	320	304	295	593	0.93	94.5	94.4	7.5	2.4	2.0	0.65	2.4	2.2	1120
200	GM 315	L 2b	2900	341	330	320	641	0.93	94.5	94.4	6.7	2.2	1.7	0.55	2.1	2.3	1150
250	GM 355	M 2a	2980	438	416	401	801	0.91	95.0	95.0	6.7	2.2	1.1	0.37	2.2	2.8	1310
315	GM 355	M 2b	2975	545	518	499	1011	0.92	95.0	95.0	7.3	2.4	1.3	0.43	2.3	3.6	1460
355	GM 355	M 2c	2980	610	580	563	1138	0.93	95.0	95.0	8.0	2.6	1.3	0.43	2.3	4.2	1620
400	GM 355	L 2	2980	690	656	632	1282	0.92	95.1	95.0	8.0	2.6	1.3	0.43	2.3	4.7	1850

Motors with dark base are within the limits of efficiency class to CEMEP.



3-phase, 400 V, 50 Hz. (Eurovolt)
 Duty type : S1 (continuous)
 Degree of protection : IP 55 (TEFV)
 Insulation class : F (105K)
 Temp. Rise : Class B (80K)

RATINGS AND PERFORMANCE

Speed, Power Factor, Efficiency, Locked-rotor current and Torque values are quoted at 400V, 50 Hz

Rated output	Type	Full-load data								Starting data				Breakdown torque ratio M_K/M_N	Moment of inertia J	Weight approx. B3
		Speed n	Current I_N			Torque M_N	Power factor Cos ϕ	Efficiency η		Locked-rotor current ratio I_A/I_N		Locked-rotor torque ratio M_A/M_N				
			A					%		D.O.L.	Y/ Δ	D.O.L.	Y/ Δ			
kW	min ⁻¹	At 380V	At 400V	At 415V	Nm	At 4/4	At 3/4									kgm ²

4 pole, 1500 min⁻¹

0.06	AGM 56 4a	1370	0.24	0.25	0.27	0.42	0.56	58.7	58.6	3.0	-	2.4	-	2.6	0.00011	2.7
0.09	AGM 56 4b	1375	0.35	0.36	0.38	0.63	0.54	64.4	64.2	3.2	-	2.2	-	2.4	0.00012	2.8
0.12	AGM 63 4a	1365	0.40	0.41	0.42	0.84	0.65	58.8	58.8	3.1	-	2.0	-	2.2	0.00017	3.2
0.18	AGM 63 4b	1340	0.58	0.60	0.60	1.28	0.65	61.4	61.4	3.0	-	1.8	-	1.9	0.00021	3.7
0.25	AGM 71 4a	1380	0.81	0.81	0.82	1.73	0.68	63.6	63.5	3.3	-	1.9	-	2.2	0.00040	4.9
0.37	AGM 71 4b	1390	1.20	1.15	1.15	2.54	0.69	70.0	70.0	3.7	-	2.2	-	2.5	0.00054	5.9
0.55	AGM 80 4a	1365	1.60	1.60	1.55	3.90	0.71	70.9	70.8	3.4	-	1.8	-	2.0	0.00083	7.6
0.75	AGM 80 4b	1370	2.10	2.00	2.00	5.20	0.74	72.2	72.2	3.8	-	1.9	-	2.0	0.0011	8.7
1.1	AGM 90 S 4	1380	2.70	2.60	2.55	7.60	0.79	76.8	76.7	4.6	-	2.1	-	2.3	0.0019	11.5
1.5	AGM 90 L 4	1390	3.60	3.50	3.40	10.3	0.78	78.6	78.5	4.5	-	2.2	-	2.3	0.0024	13.6
2.2	AGM 100 L 4a	1400	5.30	5.10	5.20	15	0.77	81.3	81.2	4.9	-	2.5	-	2.6	0.0040	17.3
3	AGM 100 L 4b	1405	6.60	6.45	6.35	20.4	0.81	82.9	82.9	5.4	-	2.2	-	2.4	0.0052	20.8
4	AGM 112 M 4	1420	8.70	8.20	8.20	27	0.82	84.7	84.7	5.8	1.9	2.4	0.78	2.7	0.0092	28.7
5.5	AGM 132 S 4	1430	11.8	11.3	11	36.7	0.82	86.2	86.2	5.9	1.9	2.4	0.78	2.5	0.019	39
7.5	AGM 132 M 4	1430	15.8	15.3	15	50	0.80	87.4	87.2	6.0	1.9	2.5	0.81	2.5	0.026	47
9	C.AGM 132 M 4	1445	19	18	17.5	59.5	0.82	88.4	88.0	6.9	1.9	2.5	0.81	2.6	0.032	56
11	GM 160 M 4	1455	22.5	21.5	21	72.2	0.84	88.6	88.5	6.6	2.2	2.5	0.81	2.6	0.054	108
15	GM 160 L 4	1460	30.5	29	28.5	98	0.83	89.5	89.5	6.9	2.1	2.5	0.81	2.6	0.072	140
18.5	C. GM 160 L 4	1450	37	35	34.5	122	0.83	90.1	90.1	6.2	2.0	2.3	0.74	2.5	0.084	150
18.5	GM 180 M 4	1460	38	36	35	121	0.82	90.1	90.1	6.4	2.1	2.6	0.84	2.7	0.11	160
22	GM 180 L 4	1460	44	42	40.5	144	0.83	90.7	90.7	6.4	2.1	2.5	0.81	2.5	0.13	185
30	GM 200 L 4	1460	57	54	52	196	0.88	91.5	91.5	6.5	2.1	2.5	0.81	2.7	0.19	240
37	C. GM 200 L 4	1465	69	66	64	241	0.88	92.1	92.1	7.2	2.3	2.7	0.87	2.8	0.23	260
37	GM 225 S 4	1465	70	66	64	241	0.87	92.2	92.2	6.3	2.0	2.4	0.78	2.6	0.29	275
45	GM 225 M 4	1465	84	80	77	293	0.87	92.7	92.7	6.6	2.1	2.5	0.84	2.7	0.35	320
55	C. GM 225 M 4	1470	101	96	93	357	0.88	93.2	93.2	6.8	2.2	2.5	0.81	2.6	0.44	360
55	GM 250 M 4	1470	102	97	94	357	0.88	93.0	93.0	6.8	2.2	2.4	0.78	2.5	0.54	400
75	C. GM 250 M 4	1470	138	131	127	487	0.87	93.3	93.6	6.8	2.2	2.6	0.84	2.5	0.72	455
75	GM 280 S 4	1475	140	133	128	485	0.87	93.6	93.6	6.4	2.1	2.2	0.71	2.4	0.90	530
90	GM 280 M 4	1480	166	158	152	581	0.88	93.9	93.9	7.2	2.3	2.4	0.77	2.6	1.1	610
110	C. GM 280 M 4	1480	204	194	183	710	0.87	94.0	94.0	6.6	2.1	2.2	0.71	2.3	1.3	660
110	GM 315 S 4	1480	205	195	189	710	0.87	94.0	94.0	6.3	2.0	1.8	0.58	2.0	1.9	770
132	GM 315 M 4a	1485	245	233	225	849	0.87	94.0	94.0	6.6	2.1	2.0	0.65	2.0	2.4	890
160	GM 315 M 4b	1485	295	280	272	1029	0.88	94.3	94.2	7.1	2.3	2.0	0.65	2.3	3.1	1015
185	GM 315 L 4a	1485	340	323	312	1190	0.88	94.4	94.3	7.2	2.3	2.1	0.68	2.2	3.6	1115
200	GM 315 L 4b	1485	368	350	339	1286	0.87	94.4	94.3	7.5	2.4	2.3	0.75	2.4	3.9	1165
250	GM 355 M 4a	1485	450	428	415	1608	0.88	95.8	95.8	6.9	2.2	1.7	0.55	2.2	6.5	1450
315	GM 355 M 4b	1485	560	532	515	2026	0.89	96.2	96.2	7.3	2.3	1.6	0.58	2.0	8.1	1657
355	GM 355 M 4c	1485	635	603	582	2283	0.88	96.3	96.3	7.3	2.3	1.8	0.58	2.0	9.4	1800
400	GM 355 L 4	1485	710	675	650	2572	0.89	96.3	96.3	7.2	2.3	2.2	0.71	2.5	10	1965

Motors with dark base are within the limits of efficiency class **EFF 2** to CEMEP.

RATING AND PERFORMANCE

3-phase, 400 V, 50 Hz. (Eurovolt)
 Duty type : S1 (continuous)
 Degree of protection : IP 55 (TEFV)
 Insulation class : F (105K)
 Temp. Rise : Class B (80K)

Speed, Power Factor, Efficiency, Locked-rotor current and Torque values are quoted at 400V, 50 Hz

Rated output	Type	Full-load data								Starting data				Breakdown torque ratio M_K/M_N	Moment of inertia J	Weight approx. B3	
		Speed min^{-1}	Current I_N			Torque M_N	Power factor $\text{Cos } \phi$	Efficiency η	Locked-rotor current ratio I_A/I_N		Locked-rotor torque ratio M_A/M_N						
			At 380V	At 400V	At 415V				D.O.L.	Y/ Δ	D.O.L.	Y/ Δ					
kW			A			Nm		%									
			At 380V	At 400V	At 415V			At 4/4	D.O.L.	Y/ Δ	D.O.L.	Y/ Δ		kgm^2	kg		

6 pole, 1000 min^{-1}

0.18	AGM 71 6a	920	0.60	0.61	0.62	1.87	0.64	67.0	3.6	-	1.8	-	2.2	0.00064	5.4
0.25	AGM 71 6b	910	0.83	0.83	0.85	2.62	0.66	65.3	3.6	-	2	-	2.3	0.00086	6.3
0.37	AGM 80 6a	910	1.10	1.10	1.10	3.90	0.65	74.9	3.8	-	2	-	2.4	0.0017	8.1
0.55	AGM 80 6b	890	1.50	1.50	1.50	5.90	0.73	72.3	3.7	-	1.8	-	2	0.0022	9.5
0.75	AGM 90 S 6	910	2.20	2.10	2.10	7.90	0.70	74.0	3.8	-	1.8	-	1.9	0.0029	11.4
1.1	AGM 90 L 6	915	3.10	3.00	3.00	11.5	0.69	76.8	3.9	-	1.9	-	2.1	0.0038	13.7
1.5	AGM 100 L 6	925	3.60	3.50	3.60	15.5	0.77	76.9	4.6	-	2	-	2.2	0.0084	19.4
2.2	AGM 112 M 6	940	5.30	5.10	5.00	22.4	0.75	82.6	4.6	-	2.1	-	2.4	0.013	26.5
3	AGM 132 S 6	945	7.00	6.90	6.80	30.5	0.76	82.6	5.5	1.8	2.2	0.71	2.4	0.022	36
4	AGM 132 M 6a	940	9.40	9.00	8.80	41	0.78	82.6	4.7	1.5	2	0.65	2.4	0.028	43.5
5.5	AGM 132 M 6b	945	13	12.3	12	55.6	0.76	84.4	5	1.6	2.3	0.75	2.3	0.043	49.6
7.5	GM 160 M 6	960	16	15.2	14.3	74.6	0.82	87.1	6.4	2.1	2.4	0.77	2.9	0.079	115
11	GM 160 L 6	955	23	22	21.5	110	0.83	86.6	7	2.2	2.5	0.81	3	0.11	131
15	GM 180 L 6	960	30.5	29	28	149	0.83	89.7	6.2	2	2.2	0.71	2.7	0.16	187
18.5	GM 200 L 6a	970	38	36	35	182	0.83	89.6	6.2	2	2.1	0.68	2.9	0.21	216
22	GM 200 L 6b	975	45	43	41	216	0.82	90.5	7.3	2.4	2.3	0.75	3.4	0.26	240
30	GM 225 M 6	970	61	58	56	294	0.82	91.0	5.9	1.9	3.1	1	2.3	0.57	330
37	C. GM 225 M 6	980	75	71	69	363	0.82	91.6	6.2	2	2.6	0.84	2.4	0.71	365
37	GM 250 M 6	970	75	71	69	364	0.82	91.6	4.5	1.5	2.2	0.71	1.8	0.77	400
45	C. GM 250 M 6	975	90	88	83	441	0.82	91.8	6.8	2.2	2.5	0.81	2.1	0.99	450
45	GM 280 S 6	980	93	90	85	439	0.80	91.8	5.4	1.8	2.6	0.84	1.9	1.2	530
55	GM 280 M 6	985	113	107	104	533	0.80	92.7	5.9	1.9	3	0.97	2.1	1.5	605
75	C. GM 280 M 6	985	150	143	138	727	0.81	93.3	5.8	1.9	2.7	0.87	1.9	1.6	700
75	GM 315 S 6	985	146	139	134	727	0.83	93.3	6.6	2.1	2	0.65	2.1	3.3	740
90	GM 315 M 6a	985	175	166	161	873	0.85	92.5	6.6	2.1	2	0.65	2.1	4.1	850
110	GM 315 M 6b	990	208	198	191	1061	0.85	94.5	7	2.3	2.2	0.71	2.3	5.4	975
132	GM 315 L 6	990	247	235	227	1273	0.86	94.2	6	1.9	1.9	0.61	1.9	6.4	1040
160	GM 355 M 6a	990	305	290	281	1543	0.84	94.6	6.5	2.1	1.9	0.61	2.1	7.1	1350
200	GM 355 M 6b	990	380	361	350	1929	0.85	94.4	6.8	2.2	2.4	0.78	2.3	8.9	1540
250	GM 355 M 6c	990	474	450	431	2388	0.85	94.5	6.1	2.1	1.7	0.55	2	11	1720
315	GM 355 L 6	990	600	570	550	3039	0.84	94.5	6.8	2.2	1.9	0.61	2	13	2100

RATINGS AND PERFORMANCE

3-phase, 400 V, 50 Hz.(Eurovolt)
 Duty type : S1 (continuous)
 Degree of protection : IP 55 (TEFV)
 Insulation class : F (105K)
 Temp. Rise : Class B (80K)

Speed, Power Factor, Efficiency, Locked-rotor current and Torque values are quoted at 400V, 50 Hz

Rated output	Type	Full-load data						Starting data				Breakdown torque ratio M_K/M_N	Moment of inertia J	Weight approx. B3
		Speed min^{-1}	Current I_N			Torque M_N	Power factor Cos ϕ	Efficiency η	Locked-rotor current ratio I_A/I_N		Locked-rotor torque ratio M_A/M_N			
A			Nm	%	D.O.L.				Y/ Δ	D.O.L.	Y/ Δ	kgm^2	kg	
kW	At 380V	At 400V				At 415V	At 4/4							

8 pole, 750 min^{-1}

0.09	AGM 71 8a	690	0.41	0.41	0.42	1.3	0.54	58.2	2.3	-	1.7	-	1.9	0.00064	5.4
0.12	AGM 71 8b	670	0.60	0.60	0.62	1.7	0.49	58.4	2.2	-	1.9	-	2	0.00086	6.3
0.18	AGM 80 8a	695	0.85	0.90	0.92	2.5	0.47	62.0	3	-	2.8	-	3	0.0017	8.1
0.25	AGM 80 8b	680	1.15	1.14	1.18	3.5	0.49	64.8	2.9	-	2.6	-	2.8	0.0022	9.4
0.37	AGM 90 S 8	690	1.35	1.33	1.37	5.1	0.59	68.5	3.2	-	1.8	-	2	0.0029	11.3
0.55	AGM 90 L 8	670	1.90	1.82	1.85	7.8	0.61	71.4	3	-	1.4	-	1.7	0.0038	13.5
0.75	AGM 100 L 8a	700	2.45	2.40	2.40	10.5	0.61	74.0	3.4	-	1.8	-	2.1	0.0062	17.4
1.1	AGM 100 L 8b	680	3.45	3.30	3.30	15.4	0.66	72.9	3.2	-	1.7	-	1.8	0.0084	19.3
1.5	AGM 112 M 8	700	4.50	4.40	4.20	20.5	0.63	77.6	3.6	-	1.9	-	2.2	0.013	26.5
2.2	AGM 132 S 8	700	5.70	5.40	5.30	30	0.74	79.0	3.8	1.2	2.1	0.68	2.4	0.024	35
3	AGM 132 M 8	690	7.70	7.30	7.20	41.5	0.74	79.9	3.6	1.2	2.2	0.71	2.2	0.033	43
4	GM 160 M 8a	710	9.60	9.10	9.00	53.8	0.76	84.0	4.8	1.6	2.1	0.68	2.4	0.060	97
5.5	GM 160 M 8b	720	13.2	12.5	12.3	73	0.75	84.4	5.3	1.7	2.2	0.71	2.7	0.083	107
7.5	GM 160 L 8	715	18	17	16.8	100	0.74	86.3	5.8	1.9	2.4	0.77	2.9	0.12	138
11	GM 180 L 8	720	25	24	23.5	146	0.76	86.9	6.8	2.2	2.7	0.87	3	0.20	180
15	GM 200 L 8	725	33	31.5	30.8	197	0.77	88.9	6	1.9	2.1	0.68	2.9	0.29	234
18.5	GM 225 S 8	725	39.5	37.5	37	244	0.79	89.6	5.8	1.9	2	0.65	2.7	0.43	265
22	GM 225 M 8	725	47	45	44	290	0.80	88.7	5.8	1.9	2	0.65	2.6	0.52	310
30	GM 250 M 8	735	62	59	58	390	0.80	91.4	6.1	2	1.8	0.58	2.6	0.92	405
37	GM 280 S 8	730	77	73	72	484	0.80	91.3	4.7	1.5	2	0.65	2	1.3	500
45	GM 280 M 8	730	90	86	84	589	0.81	92.9	4.9	1.6	1.9	0.61	1.8	1.6	565
55	GM 315 S 8	740	110	105	103	710	0.81	93.7	5.7	1.8	1.8	0.58	1.9	3.3	740
75	GM 315 M 8a	740	153	145	142	968	0.81	92.7	5.9	1.9	1.9	0.61	2	4.1	850
90	GM 315 M 8b	740	180	171	168	1162	0.81	93.6	6.2	2	1.9	0.61	2	5.4	975
110	GM 315 L 8	740	220	209	205	1420	0.81	93.6	6.5	2.1	1.9	0.61	2	6.4	1040
132	GM 355 M 8a	740	275	261	256	1704	0.77	94.5	6	1.9	1.9	0.61	2	7.1	1350
160	GM 355 M 8b	740	325	309	302	2065	0.79	94.2	6	1.9	1.9	0.61	2	8.9	1540
200	GM 355 M 8c	740	408	388	380	2581	0.79	94.4	6	1.9	1.9	0.61	2	11	1720
250	GM 355 L 8	740	500	475	458	3226	0.79	94.5	6	1.9	1.9	0.61	2	13	2100

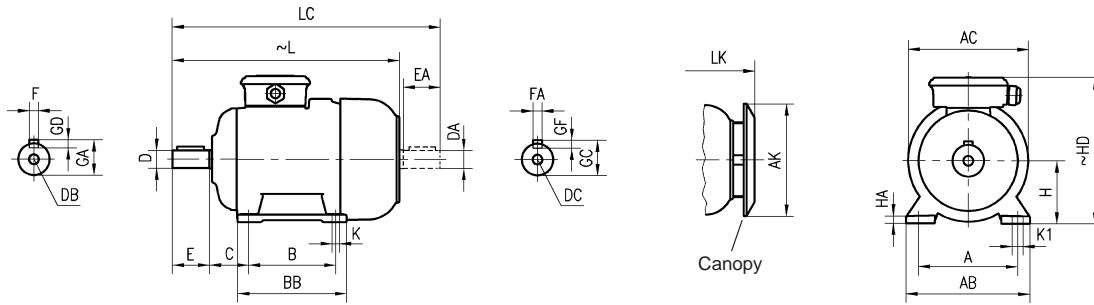

Frame Size	Number of pole	Dimensions of foot mounted motors for mounting arrangements : B3, B6 ³⁾ , B7 ³⁾ , B8 ³⁾ , B15, V5 ³⁾ , V6 ³⁾																						
		H	HD	HA	A	AB	AC	AK	K	K1	B	BB	L	LC	LK	C	E	DB ⁴⁾	D	GA	FxGD			
			~			∅	∅	∅				~				EA	DC	∅	GC	FAxGF				
56	2-4	56	152	9	90	112	106	-	5.8	9	71	87	161	185	-	36	20	M4	9	10.2	3X3			
63	2-4	63	160	10	100	125	121	116	7	11	80	103	215	242	244	40	23	M4	11	12.5	4X4			
71	2-4-6-8	71	182	10	112	140	138	116	7	11	90	108	247	282	276	45	30	M5	14	16	5X5			
80	2-4-6-8	80	198	10	125	160	156	150	10	15	100	125	278	323	307	50	40	M6	19	21.5	6X6			
90	S L	2-4-6-8	90	216	12	140	180	176	150	10	15	100	130	308	363	337	56	50	M8	24	27	8X7		
												125	155	333	388	362								
100	L	2-4-6-8	100	235	13	160	200	194	188	12	18	140	175	375	441	415	63	60	M10	28	31	8X7		
												4 ¹⁾	406	472	446									
112	M	2-4-6-8	112	258	13	190	230	218	188	12	18	140	175	394	460	434	70	60	M10	28	31	8X7		
												4 ²⁾	423	489	463									
132	S M	2-4-6-8	132	300	15	216	260	258	230	12	18	140	180	455	541	495	89	80	M12	38	41	10X8		
												178	218	493	579	533								
160	M L	2-4-6-8	160	385	22	254	312	310	290	15	-	210	260	601	717	658	108	110	M16	42	45	12X8		
												254	304	645	761	702								
180	M L	2-4-6-8	180	421	24	279	354	348	290	15	-	241	291	659	775	716	121	110	M16	48	51.5	14X9		
												279	329	697	813	754								
200	L	2-4-6-8	200	475	26	318	400	385	370	19	-	305	355	747	865	803	133	110	M20	55	59	16X10		
225	S M	4-8	225	510	30	356	436	433	370	19	-	286	346	795	943	851	149	140	M20	60	64	18X11		
												311	371	790	908	846		110		55			59	16X10
												4-6-8	820	968	876	140		60		64			18X11	
250	M	2	250	572	35	406	484	480	440	24	-	349	410	900	1048	956	168	140	M20	60	64	18X11		
												4-6-8	65	69	18X11									
280	S	2	280	630	40	457	556	536	440	24	-	368	450	958	1106	1014	190	140	M20	65	69	18X11		
												4-6-8	75	79.5	20X12									
	M	2	280	630	40	457	556	536	440	24	-	-	419	501	1010	1158	1066	190	140	M20	65	69	18X11	
													4-6-8	75	79.5	20X12								
315	S	2	315	840	50	508	630	579	570	28	-	406	500	1068	1218	1145	216	140	M20	65	69	18X11		
												4-6-8	1098	1278	1175	170		80		85			22X14	
	M	2	315	840	50	508	630	579	570	28	-	457	550	1120	1270	1197	216	140	M20	65	69	18X11		
												4-6-8	1150	1330	1227	170		80		85			22X14	
	L	2	315	840	50	508	630	579	570	28	-	-	508	600	1190	1340	1267	216	140	M20	65	69	18X11	
													4-6-8	1220	1400	1297	170		85		90			22X14
355	M	2	355	990	50	610	740	732	570	28	-	560	680	1330	1510	1407	254	170	M20	80	85	22X14		
												4-6-8	1370	1590	1447	210		M24		100			106	28X16
	L	2	355	990	50	610	740	732	570	28	-	-	630	750	1400	1580	1477	254	170	M20	80	85	22X14	
													4-6-8	1440	1660	1517	210		M24		100			106

Tolerances

¹⁾ (EFF) motor type AGME 100 L 4b
²⁾ (EFF) motor type AGME 112 M 4

³⁾ B6, B7, B8, V5 and V6 are up to frame size 315 L
⁴⁾ DB, DC to DIN 332 form D

All dimensions in mm.

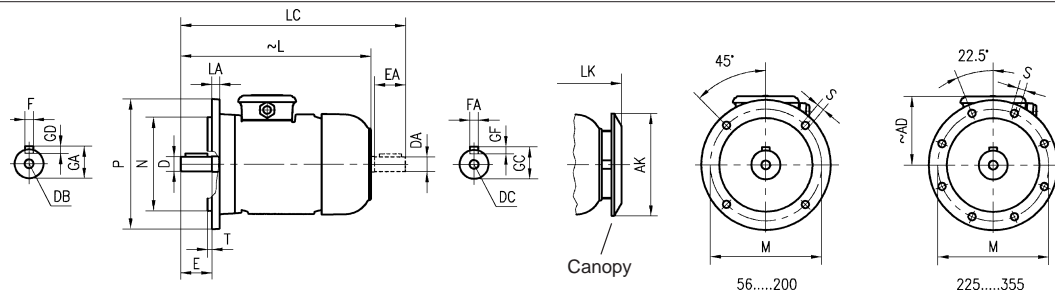

Note: The seating face of the flange lies in the same plane as the shoulder on the shaft

Frame Size	Number of pole	Dimensions of flanged motors : (D-Flange form A - DIN 42 948) mounting arrangements B5 ³⁾ , V1 ³⁾ , V3 ³⁾																		
		Flange number	MØ	NØ	PØ	Clearance hole		T	LA	AD	AK Ø	L	LC	LK	E EA	DB ⁴⁾ DC	D Ø DA Ø	GA GC	FxGD FxGF	
						No	SØ													
56	2-4	F 100	100	80	120	4	7	3	8	96	-	161	185	-	20	M4	9	10.2	3X3	
63	2-4	F 115	115	95	140	4	10	3	10	98	116	215	242	244	23	M4	11	12.5	4X4	
71	2-4-6-8	F 130	130	110	160	4	10	3.5	10	110	116	247	282	276	30	M5	14	16	5X5	
80	2-4-6-8	F 165	165	130	200	4	12	3.5	12	118	150	278	323	307	40	M6	19	21.5	6X6	
90	2-4-6-8	F 165	165	130	200	4	12	3.5	12	126	150	308	363	337	50	M8	24	27	8X7	
												333	388	362						
100	L	F 215	215	180	250	4	14.5	4	15	135	188	375	441	415	60	M10	28	31	8X7	
												406	472	446						
112	M	F 215	215	180	250	4	14.5	4	15	146	188	394	460	434	60	M10	28	31	8X7	
												423	489	463						
132	S M	F 265	265	230	300	4	14.5	4	20	168	230	455	541	495	80	M12	38	41	10X8	
												493	579	533						
160	M L	F 300	300	250	350	4	18.5	5	20	225	290	601	717	658	110	M16	42	45	12X8	
												645	761	702						
180	M L	F 300	300	250	350	4	18.5	5	20	241	290	659	775	716	110	M16	48	51.5	14X9	
												697	813	754						
200	L	F 350	350	300	400	4	18.5	5	20	275	370	747	865	803	110	M20	55	59	16X10	
225	S	F 400	400	350	450	8	18.5	5	20	285	370	795	943	851	140	M20	60	64	18X11	
	M											2	790	908	846		110	55	59	16X10
	4-6-8											820	968	876	140		60	64	18X11	
250	M	F 500	500	450	550	8	18.5	5	22	322	440	900	1048	956	140	M20	60	64	18X11	
																	4-6-8	65	69	18X11
280	S	F 500	500	450	550	8	18.5	5	24	350	440	958	1106	1014	140	M20	65	69	18X11	
												4-6-8	75	79.5			20X12			
	M											2	1010	1158			1066	65	69	18X11
												4-6-8	75	79.5			20X12			
315	S	F 600	600	550	660	8	24	6	24	550	570	1068	1218	1145	140	M20	65	69	18X11	
												4-6-8	80	85	22X14					
	M											2	1120	1270	1197		140	65	69	18X11
												4-6-8	80	85	22X14					
	L											2	1190	1340	1267		140	65	69	18X11
												4-6-8	85	90	22X14					
355	M	F 740	740	680	800	8	24	6	32	635	570	1330	1510	1407	170	M20	80	85	22X14	
												4-6-8	100	106	28X16					
	L											2	1400	1580	1477	170	M20	80	85	22X14
												4-6-8	100	106	28X16					
Tolerances			j6																	

1) motor type AGME 100 L 4b
2) motor type AGME 112 M 4

3) B5 and V3 are up to frame size 315 L
4) DB, DC to DIN 332 form D

All dimensions in mm.

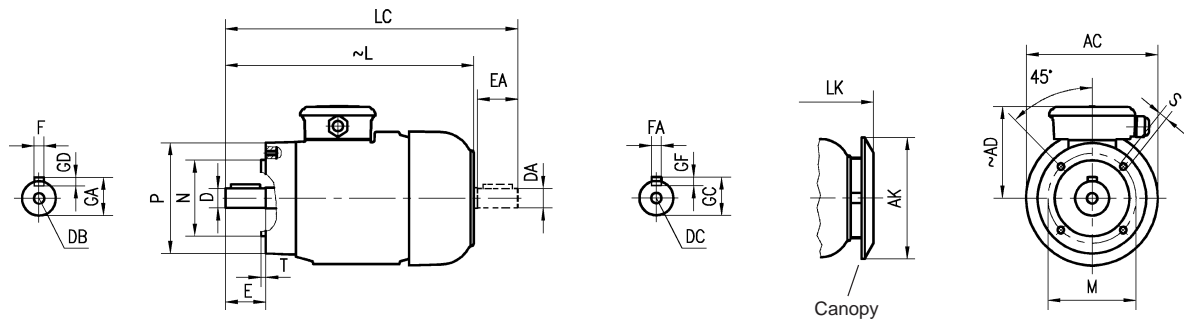

Note: The seating face of the flange lies in the same plane as the shoulder on the shaft

Frame Size	Number of pole	Dimensions of flanged motors : (C-Face Flange form C - DIN 42 948) mounting arrangements B14, V18, V19																				
		Flange number	MØ	NØ	PØ	S	T	LA	AC Ø	AK Ø	AD ~	L ~	LC	LK ~	E EA	DB ³⁾ DC	D Ø DA Ø	GA GC	FxGD FxGF			
56	2-4-6-8	F 65	65	50	80	M5	2.5	10	106	-	96	161	185	-	20	M4	9	10.2	3x3			
		F 85	85	70	105	M6		12														
63	2-4-6-8	F 75	75	60	90	M5	2.5	10	121	116	98	215	242	244	23	M4	11	12.5	4x4			
		F 100	100	80	120	M6	3	12														
71	2-4-6-8	F 85	85	70	105	M6	2.5	12	138	116	110	247	282	276	30	M5	14	16	5x5			
		F 115	115	95	140	M8	3	16												-		
80	2-4-6-8	F 100	100	80	120	M6	3	12	156	150	118	278	323	307	40	M6	19	21.5	6x6			
		F 130	130	110	160	M8	3.5	16												-		
90	2-4-6-8	F 115	115	95	140	M8	3	16	176	150	126	308	363	337	50	M8	24	27	8x7			
		F 130	130	110	160		3.5															
		F 115	115	95	140		3															
		F 130	130	110	160		3.5															
100	2-4-6-8	F 130	130	110	160	M8	3.5	16	194	188	135	375	441	415	60	M10	28	31	8x7			
	4 ¹⁾																			406	472	446
	2-4-6-8																			375	441	415
	4 ¹⁾																			406	472	446
112	2-4-6-8	F 130	130	110	160	M8	3.5	16	218	188	146	394	460	434	60	M10	28	31	8x7			
	4 ²⁾																			423	489	463
	2-4-6-8																			394	460	434
	4 ²⁾																			423	489	463
132	2-4-6-8	F 165 ⁴⁾	165	130	200	M10	3.5	18	258	230	168	455	541	495	80	M12	38	41	10x8			
		F 215 ⁴⁾	215	180	250	M12	4															
		F 165 ⁴⁾	165	130	200	M10	3.5															
		F 215 ⁴⁾	215	180	250	M12	4															
160	M	2-4-6-8	F 215 ⁴⁾	215	180	250	M12	4	18	310	290	225	601	717	658	100	M16	42	45	12x8		
	L												645	761	702							
Tolerances			j6																			

1) motor type AGME 100 L 4b
2) motor type AGME 112 M 4

3) DB, DC to DIN 332 form D
4) Flanges are cast iron

All dimensions in mm.

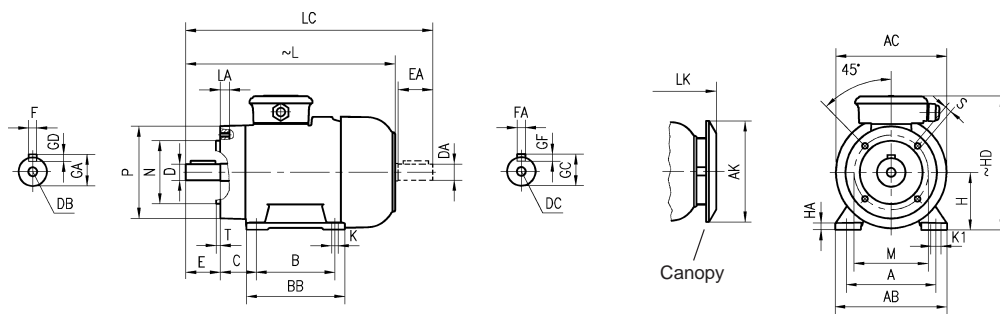

Note: The seating face of the flange lies in the same plane as the shoulder on the shaft

Frame size	Number of pole	Dimensions of foot and flange mounted motors : (C-Face Flange form C - DIN 42 948) mounting arrangements : B34																																						
		H	HD	HA	A	AB	AC Ø	AK Ø	K Ø	K1	B	BB	Flange Number	MØ	NØ	PØ	S	T	LA	L	LC	LK	C	E EA	DB ³⁾ DC	D Ø DA Ø	GA GC	FxGD FxGF												
56	2-4-6-8	56	152	9	90	112	106	-	5.8	9	71	87	F 65	65	50	80	M5	2.5	10	161	185	-	36	20	M4	9	10.2	3x3												
													F 85	85	70	105	M6												85	70	105	M6	3	12	247	282	276	45	30	M5
63	2-4-6-8	63	160	10	100	125	121	116	7	11	80	103	F 75	75	60	90	M5	2.5	10	215	242	244	40	23	M4	11	12.5	4x4												
													F 100	100	80	120	M6												3	12	278	323	307	50	40	M6	19	21.5	6x6	
71	2-4-6-8	71	182	10	112	140	138	116	7	11	90	108	F 85	85	70	105	M6	2.5	12	247	282	276	45	30	M5	14	16	5x5												
							-						156	150	10	15	100												125	F 115	115	95	140	M8	3	16	333	388	362	24
80	2-4-6-8	80	198	10	125	160	-	150	10	15	100	125	F 100	100	80	120	M6	3	12	278	323	307	50	40	M6	19	21.5	6x6												
							-						156	150	10	15	100												125	F 130	130	110	160	M8	3.5	16	333	388	362	24
90	2-4-6-8	90	216	12	140	180	176	150	10	15	100	130	F 115	115	95	140	M8	3	16	308	363	337	56	50	M8	24	27	8x7												
													F 130	130	110	160													3.5	16	333	388	362	24	27	8x7				
													F 115	115	95	140													3	16	333	388	362	24	27	8x7				
													F 130	130	110	160													3.5	16	333	388	362	24	27	8x7				
100	2-4-6-8	100	235	13	160	200	194	188	12	18	140	175	F 130	130	110	160	M8	3.5	16	375	441	415	63	60	M10	28	31	8x7												
	4 ¹⁾												406	472	446	28													31	8x7										
	2-4-6-8												375	441	415	63													60	M10	28	31	8x7							
	4 ¹⁾												406	472	446	28													31	8x7										
112	2-4-6-8	112	258	13	190	230	218	188	12	18	140	175	F 130	130	110	160	M8	3.5	16	394	460	434	70	60	M10	28	31	8x7												
	4 ²⁾												423	489	463	28													31	8x7										
	2-4-6-8												394	460	434	70													60	M10	28	31	8x7							
	4 ²⁾												423	489	463	28													31	8x7										
132	2-4-6-8	132	300	15	216	260	258	230	12	18	140	180	F 165 ⁴⁾	165	130	200	M10	3.5	18	455	541	495	89	80	M12	38	41	10x8												
													F 215 ⁴⁾	215	180	250													M12	4	493	579	533	41	10x8					
													F 165 ⁴⁾	165	130	200													M10	3.5	18	601	717	658	108	110	M16	42	45	12x8
													F 215 ⁴⁾	215	180	250													M12	4	18	645	761	702	108	110	M16	42	45	12x8
160	2-4-6-8	160	385	22	254	312	310	290	15	-	210	260	F 215 ⁴⁾	215	180	250	M12	4	18	601	717	658	108	110	M16	42	45	12x8												
													254	304	645	761													702	108	110	M16	42	45	12x8					
Tolerances		-0.5											j6																											

¹⁾ motor type AGME 100 L 4b
²⁾ motor type AGME 112 M 4
³⁾ DB, DC to DIN 332 form D
⁴⁾ Flanges are cast iron

All dimensions in mm.

SPARES

The spare-parts are fully interchangeable as they are designed and manufactured to fine limits of their dimensional tolerances.

Please state motor type, serial number, type of construction/mounting arrangement and, part number with full description when ordering spare parts.

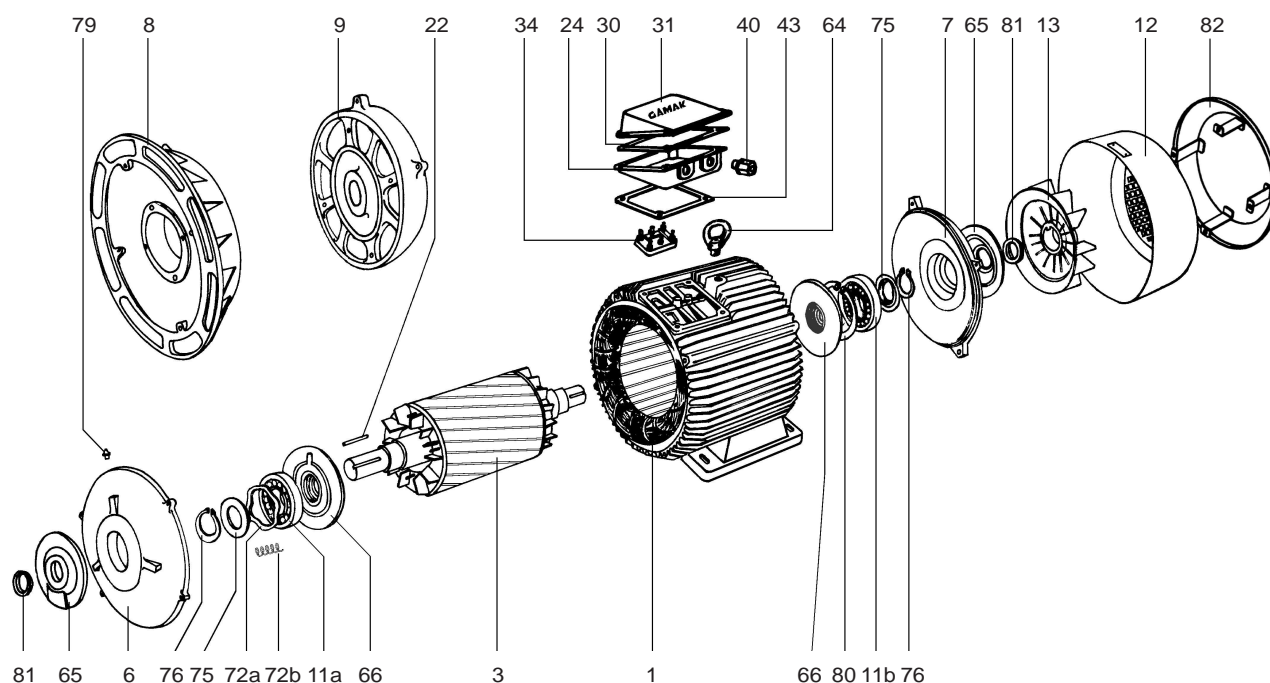

Part No.	Description	
1	Stator complete with winding, varnished and fitted in the frame	
3	Rotor complete with shaft, finish machined and balanced (Excluding keys)	
6	End shield Drive-end B3 mounting	
7	End shield Non Drive-end	
8	D-Flange (Form A)	DIN 42 948
9	C-Face Flange (Form C)	DIN 42 948
11 a	Bearing Drive-end (Ball or Roller)	DIN 625 or DIN 5412
11 b	Ball-bearing Non Drive-end	DIN 625
12	Fan cover (63 to 355)	
13	Fan (63 to 355)	
22	Shaft key	DIN 6885
24	Terminal-box	
30	Terminal-box to lid gasket	
31	Terminal-box lid	
34	Terminal board complete with terminal links, nuts and washers	DIN 46 294
40	Cable-gland	DIN 46 320
43	Terminal-box to frame gasket	
64	Eye bolt (160 to 355)	DIN 580
65	External bearing cap (motors with greasing nipples)	
66	Internal bearing cap (motors with greasing nipples)	
72a	Corrugated disc spring for preloading ball-bearing (56 to 280)	
72b	Helical compression spring (315 - 355)	
75	Grease retaining disc (motors with greasing nipples)	
76	External circlip for retaining ball-bearing and grease retaining disc on the shaft (At DE, N.DE of motors with greasing nipples, and at N.DE of frames 160 to 280)	DIN 471
79	Greasing nipple (315 and 355 standard, 160 to 280 optional)	DIN 71 412
80	Internal circlip for retaining ball-bearing at Non Drive-end shield (160 to 280)	DIN 472
81	V-Ring (Oil-Seal)	(DIN 3760 Form "A")
82	Canopy	

GAMAK

THE
A *Credible.*
Alternative

QUALITY WITH
SERVICE
THAT'S READILY
AVAILABLE
NATIONWIDE
ON ALL OUR DESIGNS

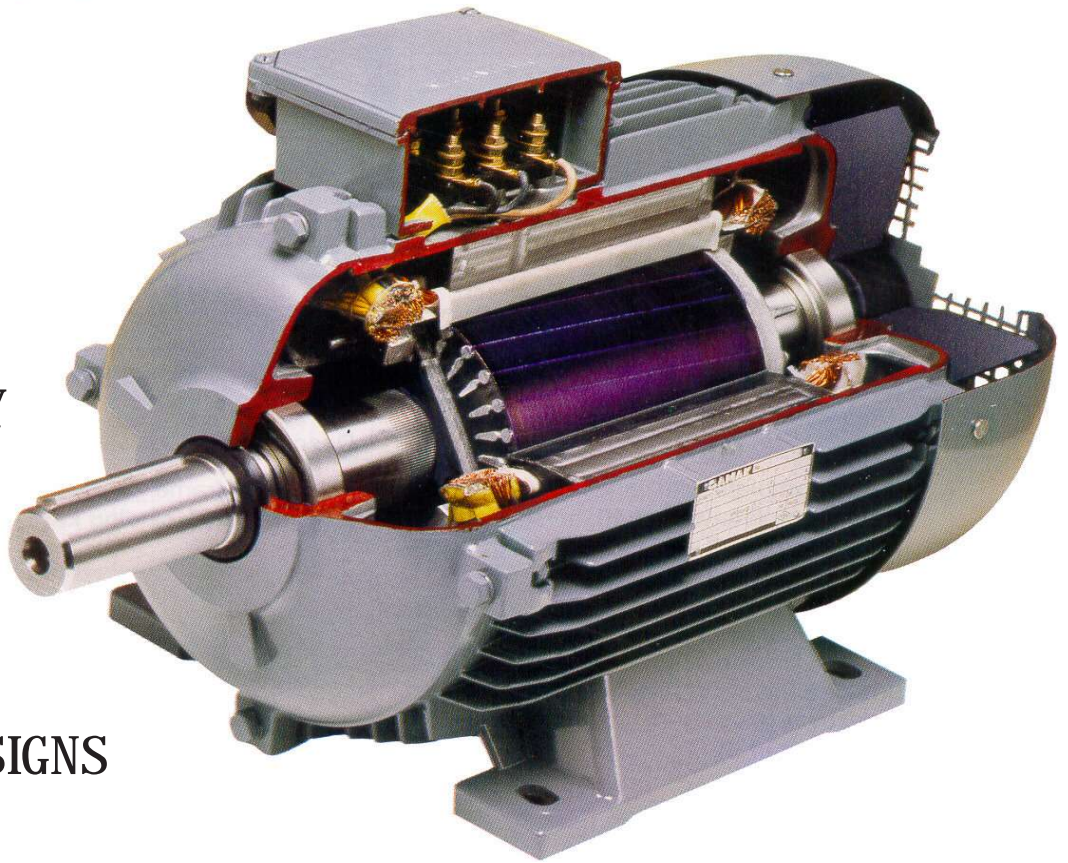

- Class "F" insulation with class "B" Temp. Rise — Gives you reliability and longer life
- 400 V Euro voltage, 50 Hz and 60 Hz supplies — One motor for the U.K. mainland/Europe and beyond
- High efficiencies - High power factors — Energy efficiency - Lowering your running costs
- Low noise levels — For your peace of mind
- Frame range 56 - 355 2/4/6/8 pole including flameproof — Covering all your requirements

Available ex - stock
nationwide delivery service

Ring the team now on (01226) 382727
or Fax: (01226) 383370 for all your needs

GAMAK MOTORS LTD.

Claycliffe Business Park, Barugh Green Road, Barugh Green,
Barnsley, South Yorkshire S75 1JU

GAMAK

THE MANUFACTURER OF ELECTRIC MOTORS

MANUFACTURING PROGRAMME

- 3-Phase, totally-enclosed (IP 55), cage induction motors
 - IEC Frame sizes : 56...355
- Totally-enclosed (IP 55), pole-changing (Multi speed) cage-induction motors
 - For machine tools (with constant load-torque)
 - For pumps and ventilators (where the torque rises with the square of the speed)
- Brake motors
- Totally enclosed (IP 55) cage induction motors integrated with frequency converters
- Forced ventilation kit
- Totally enclosed (IP 55) cage induction reluctance motors
- Single-phase, totally enclosed (IP 55), cage induction motors (IEC frame sizes)
- Single-phase, fractional horse power shaded pole motors



GAMAK MOTORS LTD.

Claycliffe Business Park
Barugh Green Road, Barugh Green
BARNLEY, SOUTH YORKSHIRE
S75 1JU

Tel : 01226.382 727

Fax: 01226.383 370

E-mail: gamakmotors@totalise.co.uk