

KANTHAL HANDBOOK

Heating Alloys for Electric Household Appliances

KANTHAL HEATING ALLOYS Handbook



KANTHAL

KANTHAL AB
Box 502, SE-734 27 Hallstahammar, Sweden
www.kanthal.com
Tel +46 220 210 00
Fax +46 220 211 66
A Sandvik Company



Copyright by Kanthal AB.
May be reproduced only with proper
acknowledgement of the source.

Catalogue 1-A-4-3

Production: ReklamCenter 03057.

Printed in Sweden by Primatryck, 2003-02.3000

This information, which may be subject to change, is offered solely for your consideration and should not be taken as warranty or representation for which we assume legal responsibility. It is not to be understood as permission or recommendation to practice a patented invention without a license and the user should determine weather relevant patent exist.

© KANTHAL, NIKROTHAL, ALKROTHAL, SUPERTHAL,

FIBROTHAL and CUPROTHAL are Registered

Trademarks of Kanthal Group companies in Sweden and other countries.

™ NIFETHAL, ECOTHAL

Kanthal is never far away!

This handbook contains basic technical and product data for our resistance and resistance heating alloys for the appliance industry.

We have also included design-, calculation- and application guidelines, in order to make it easier to select the right alloy and to design the right element.

More information is given on www.kanthal.com. There you can find product news and other Kanthal product information and handbooks ready to be downloaded as well as information on the Kanthal Group and the nearest Kanthal office.

Kanthal alloys are also produced in a range for industrial furnaces and as ready-to-install elements and systems and as precision wire in very small sizes. Ask for the special handbooks covering those areas.

We have substantial technical and commercial resources at all our offices around the world and we are glad to help you in different technical questions, or to try out completely new solutions at our R & D facilities.

Kanthal is never far away!

Hallstahammar, February 2003

KANTHAL AB
Box 502, SE-734 27 Hallstahammar, Sweden
www.kanthal.com
Tel +46 220 210 00
Fax +46 220 211 66

Contents

	Page
1. Resistance Heating Alloys	4
NiFe	
NIFETHAL 70, NIFETHAL 52	4
Austenitic Alloys (NiCr, NiCrFe)	
NIKROTHAL 80, NIKROTHAL 70, NIKROTHAL 60, NIKROTHAL 40, NIKROTHAL 20	5
Ferritic Alloys (FeCrAl)	
KANTHAL APM, A-1, A, AF, AE, D, ALKROTHAL	5
Comparison between KANTHAL and NIKROTHAL	
KANTHAL advantages	6
NIKROTHAL advantages	7
Summary	8
Copper Nickel Alloys	
CUPROTHAL 49, MANGANINA 43, (CUPROTHAL 30, 15, 10 and 05)	9
Product varieties	11
2. Physical and Mechanical Properties	12
Table KANTHAL alloys	11
Table ALKROTHAL, NIKROTHAL and NIFETHAL alloys	13
Table CUPROTHAL and MANGANINA alloys	14
3. Stranded Resistance Heating Wire	15
Strand diameter	15
Standard stocked material	16
Flexible terminations	16
4. Thin Wide Strip	18
5. Design factors	20
Operating life	20
Oxidation properties	20
Corrosion resistance	21
Maximum temperature per wire size	22
6. Element types and heating applications	23
Description	23
Embedded elements	24
Supported elements	30
Suspended elements	36

	Page	
7. Standard Tolerances	42	
Electrical resistance	42	
Diameter of wire	42	1
Dimensions of cold rolled ribbon	42	
8. Delivery forms	43	
Resistance heating alloys	43	2
Resistance alloys	45	
9. Tables	47	
KANTHAL A-1, APM, wire	48	3
KANTHAL A, AF, AE, wire	49	
KANTHAL A, AF, AE, ribbon	50	
KANTHAL D, wire	52	4
KANTHAL D, DT, ribbon	53	
ALKROTHAL, wire	55	
ALKROTHAL, ribbon	56	
NIKROTHAL 80, 70, wire	58	5
NIKROTHAL 60, wire	59	
NIKROTHAL 40, 20, wire	60	
NIKROTHAL 80, 60, 40, ribbon	61	
NIFETHAL 70, 52, wire	63	6
CUPROTHAL 49, MANGANINA 43, CUPROTHAL 30, 15, 10 and 05, wire	64	
CUPROTHAL 49, ribbon	66	
10. Appendix	68	7
List of symbols	68	
Formulas and definitions	69	
Formulas for values in chapter 9, Tables	73	8
Relationship between metric and imperial units	76	
Design calculations for heating elements	77	
Wire gauge conversion table	82	
Temperature conversion table	83	9
Miscellaneous conversion factors	86	
11. The complete Kanthal product range	90	10
		11

1. Resistance Heating Alloys

The resistance heating alloys can be divided into two main groups.

The FeCrAl (KANTHAL) and the NiCr (NIKROTHAL) based alloys. For lower temperature applications CuNi and NiFe based alloys are also used. The different alloys are described below as well as a comparison of some of the properties of the KANTHAL and the NIKROTHAL alloys.

NiFe

**Up to 600 °C 1110 °F:
NIFETHAL 70 and 52**

are alloys with low resistivity and high temperature coefficient of resistance. The positive temperature coefficient allows heating elements to reduce power as temperature increases. Typical applications are in low temperature tubular elements with self regulating features.

Spools and Pail Pack.



Austenitic Alloys (NiCr, NiCrFe)

Up to 1200 °C 2190 °F: NIKROTHAL 80 is the austenitic alloy with the highest nickel content. Because of its good workability and high-temperature strength, NIKROTHAL 80 is widely used for demanding applications in the electric appliance industry.

Up to 1250 °C 2280 °F: NIKROTHAL 70 (Normally used in furnace applications).

Up to 1150 °C 2100 °F: NIKROTHAL 60 has good corrosion resistance, good oxidation properties and very good form stability. The corrosion stability is good except in sulphur containing atmospheres. Typical applications for NIKROTHAL 60 are in tubular heating elements and as suspended coils.

Up to 1100 °C 2010 °F: NIKROTHAL 40 is used as electric heating element material in domestic appliances and other electric heating equipment at operating temperatures up to 1100 °C 2010 °F.

Up to 1050 °C 1920 °F: NIKROTHAL 20 (Produced on volume based request.)

Ferritic Alloys (FeCrAl)

Up to 1425 °C 2560 °F: KANTHAL APM (Normally used in furnace applications).

Up to 1400 °C 2550 °F: KANTHAL A-1 (Normally used in furnace applications).

Up to 1350 °C 2460 °F: KANTHAL A is used for appliances, where its high resistivity and good oxidation resistance are particularly important.

Up to 1300 °C 2370 °F: KANTHAL AF has improved hot strength and oxidation properties and is especially recommended where good form stability properties in combination with high temperature is required.

Up to 1300 °C 2370 °F: KANTHAL AE is developed to meet the extreme demands in fast response elements in glass top hobs and quartz tube heaters. It has exceptional form stability and life in spirals with large coil to wire diameter ratio.

Up to 1300 °C 2370 °F: KANTHAL D Employed chiefly in appliances, its high resistivity and low density, combined with better heat resistance than austenitic alloys, make it suitable for most applications.

Up to 1100 °C 2010 °F: ALKROTHAL is typically specified for rheostats, braking resistors, etc. It is also used as a heating wire for lower temperatures, such as heating cables.

KANTHAL Advantages

Higher maximum temperature in air

KANTHAL A-1 has a maximum temperature of 1400 °C 2550 °F;
NIKROTHAL 80 has a maximum temperature of 1200 °C 2190 °F

Longer life

KANTHAL elements have a life 2-4 times the life of NIKROTHAL when operated in air at the same temperature.

Higher surface load

Higher maximum temperature and longer life allow a higher surface load to be applied on KANTHAL elements.

Better oxidation properties

The aluminium oxide (Al_2O_3) formed on KANTHAL alloys adheres better and is therefore less contaminating. It is also a better diffusion barrier, better electrical insulator and more resistant to carburizing atmospheres than the chromium oxide (Cr_2O_3) formed on NIKROTHAL alloys.

Lower density

The density of the KANTHAL alloys is lower than that of the NIKROTHAL alloys. This means that a greater number of equivalent elements can be made from the same weight material.

Higher resistivity

The higher resistivity of KANTHAL alloys makes it possible to choose a material with larger cross-section, which improves the life of the element. This is particularly important for thin wire. When the same cross-section can be used, considerable weight savings are obtained. Further, the resistivity of KANTHAL alloys is less affected by cold-working and heat treatment than is the case for NIKROTHAL 80.

Higher yield strength

The higher yield strength of KANTHAL alloys means less change in cross-section when coiling wires.



Better resistance to sulphur

In atmospheres contaminated with sulphuric compounds and in the presence of contaminations containing sulphur on the wire surface, KANTHAL alloys have better corrosion resistance in hot state. NiCr alloys are heavily attacked under such conditions.

Weight savings with KANTHAL alloys

The lower density and higher resistivity of KANTHAL alloys means that for a given power, less material is needed when using KANTHAL instead of NIKROTHAL alloys. The result is that in a great number of applications, substantial savings in weight and element costs can be achieved.

In converting from NiCr to KANTHAL alloys, either the wire diameter can be kept constant while changing the surface load, or the surface load can be held constant while changing the wire diameter. In both cases, the KANTHAL alloy will weigh less than the NiCr alloy.

NIKROTHAL Advantages**Higher hot and creep strength**

NIKROTHAL alloys have higher hot and creep strength than KANTHAL alloys. KANTHAL APM, AF and AE are better in this respect than the other KANTHAL grades and have a very good form stability, however, not as good as that of NIKROTHAL.

Better ductility after use

NIKROTHAL alloys remain ductile after long use.

Higher emissivity

Fully oxidized NIKROTHAL alloys have a higher emissivity than KANTHAL alloys. Thus, at the same surface load the element temperature of NIKROTHAL is somewhat lower.

Non-magnetic

In certain low-temperature applications a non-magnetic material is preferred. NIKROTHAL alloys are non-magnetic (except NIKROTHAL 60 at low temperatures). KANTHAL alloys are non-magnetic above 600 °C 1100 °F

Better wet corrosion resistance

NIKROTHAL alloys generally have better corrosion resistance at room temperature than nonoxidized KANTHAL alloys. (Exceptions: atmospheres containing sulphur and certain controlled atmospheres.)



KANTHAL Resistance Heating Alloys – Summary

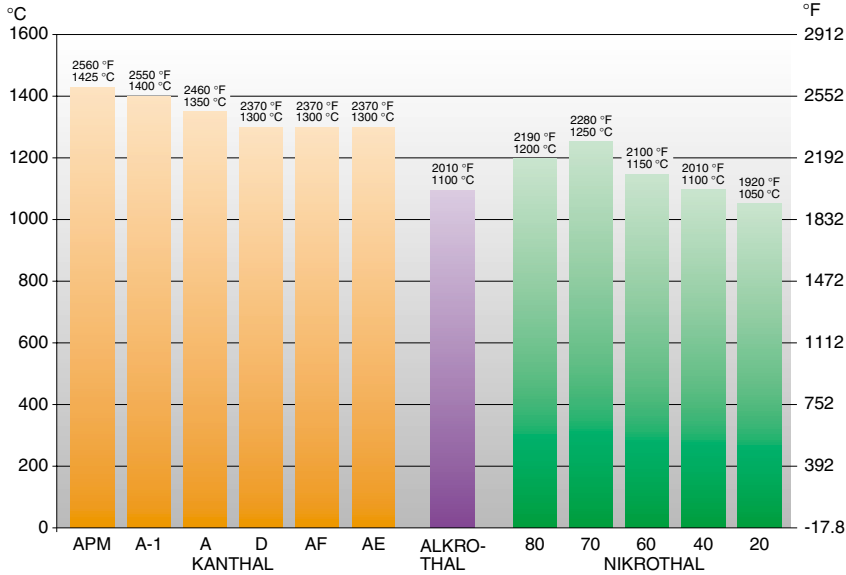

Fig. 1 - Maximum operating temperature per alloy

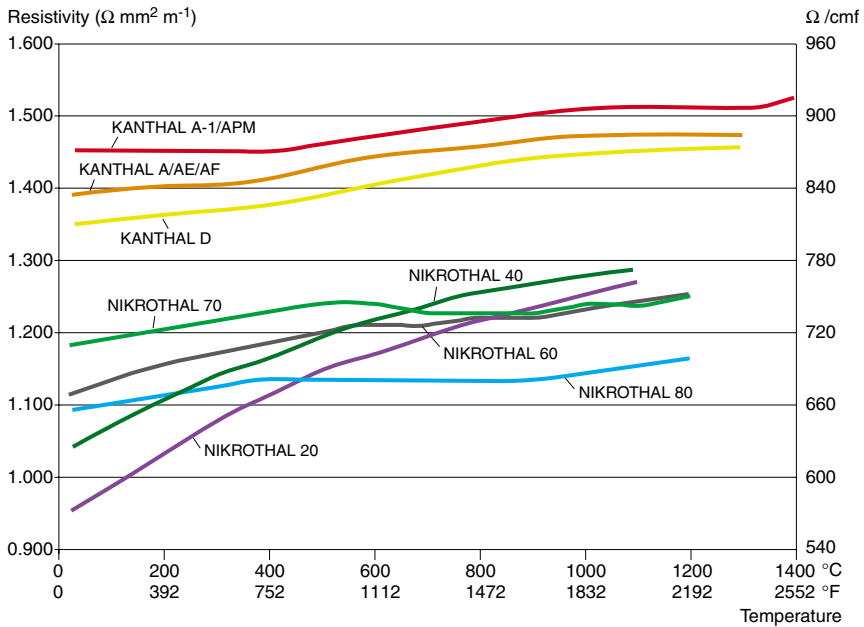

Fig. 2 - Resistivity vs. Temperature.

Copper-Nickel Alloys

CUPROTHAL 49

(universally known as Constantan) is manufactured under close control from electrolytic Copper and pure Nickel.

CUPROTHAL 49 has a number of special characteristics – some electrical, some mechanical – which make it a remarkably versatile alloy. For certain applications, its high specific resistance and negligible temperature coefficient of resistance are its most important attributes. For others, the fact that CUPROTHAL 49 offers good ductility, is easily soldered and welded and has good resistance to atmospheric corrosion is more significant.

Although the range of applications of CUPROTHAL 49 is so wide, its uses fall into four principal categories:

- An ideal alloy for winding heavy-duty industrial rheostats and electric motor starter resistance. High specific resistance, together with good ductility and resistance to corrosion are all important requirements in this category, and CUPROTHAL 49 satisfies the most demanding specifications.
- CUPROTHAL 49 is widely used in wire-wound precision resistors, temperature-stable potentiometers, volume control devices and strain gauges. (See the Precision Wire Handbook). In the resistor field, its high resistance and negligible temperature coefficient of resistance are its main attractions.
- The third main category of application exploits another characteristic of CUPROTHAL 49. This is the fact that it develops a high thermal E.M.F. against certain other metals. CUPROTHAL 49 is therefore commonly used as a thermocouple alloy.
- Low temperature resistance heating applications, such as heating cables.

MANGANINA 43

has been developed to satisfy many precision and high stability requirements at, or close to, room temperature.

In some applications it is essential that the resistance of the electronic components does not change either with age or with such changes of temperature as may be encountered in normal use. These requirements are fulfilled perfectly by MANGANINA 43.

The resistance of MANGANINA 43 increases very slightly from 15 °C to approximately 25 °C. Above 25 °C the resistance decreases so that the resistance at 35 °C is about the same as at 15 °C. The maximum change in resistance to be expected is less than 15 parts per million per degree centigrade. Therefore, for an instrument, which is calibrated at 25 °C, the change in resistance over the temperature range from 15-35 °C is negligible, except in instances where the work is of very high precision.

Artificial ageing of assembled coils has been found necessary to avoid a slow decrease in resistance with time. Baking at a temperature between 120 °C and 140 °C for a period of 24 to 72 hours commonly does this.

The higher temperature limit must not be exceeded if damage to enamel or fabric insulation is to be avoided. Regarding E.M.F. versus copper, MANGANINA 43 generates not more than 0.003 mV/°C between 0 and 100 °C.

The main application is in shunts.

Copper-Nickel alloys with medium and low resistivity

KANTHAL produces Copper-Nickel alloys with resistivities lower than those of CUPROTHAL 49 and MANGANINA 43. The main applications are in high current electrical resistances, heating cables, electric blankets, fuses, resistors but they are also used in many other applications.

CUPROTHAL 30

resistivity 30 microhm-cm

CUPROTHAL 15

resistivity 15 microhm-cm

CUPROTHAL 10

resistivity 10 microhm-cm

CUPROTHAL 05

resistivity 5 microhm-cm

Different resistors and potentiometers using KANTHAL alloys.



Product Varieties

	Rod	Wire	Strip	Ribbon	Thin wide Strip	Welded tubes	Extruded tubes	Straightened wire
KANTHAL								
KANTHAL APM	•	•	•				•	•
KANTHAL A-1	•	•	•					•
KANTHAL A		•		•				•
KANTHAL D, DT	•	•	•	•				•
KANTHAL AF		•	•	•	•	•		•
KANTHAL AE	•	•	•	•	•			•
ALKROTHAL								
	•	•	•	•				•
NIKROTHAL								
NIKROTHAL 80		•	•	•				•
NIKROTHAL 70		•	•					•
NIKROTHAL 60		•	•	•				•
NIKROTHAL 40	•	•	•	•				•
NIKROTHAL 20		•						•
KANTHAL/NiFe								
NIFETHAL 70		•						•
NIFETHAL 52		•						•
Copper-Nickel								
CUPROTHAL 49	•	•	•	•				•
MANGANINA		•						•
CUPROTHAL 30		•						•
CUPROTHAL 15		•						•
CUPROTHAL 10		•						•
CUPROTHAL 05		•						•

2. Physical and Mechanical properties

		KANTHAL APM	A-1	A	AF	AE
Max continuous operating temperature (element temperature in air),	°C °F	1425 2600	1400 2550	1350 2460	1300 2370	1300 2370
Nominal composition, %	Cr Al Fe Ni	22 5.8 Balance –	22 5.8 Balance –	22 5.3 Balance –	22 5.3 Balance –	22 5.3 Balance –
Density,	g/cm ³ lb/in ³	7.10 0.256	7.10 0.256	7.15 0.258	7.15 0.258	7.15 0.258
Resistivity at 20 °C, at 68 °F	Ω mm ² m ⁻¹ Ω/cm ²	1.45 872	1.45 872	1.39 836	1.39 836	1.39 836
Temperature factor of the resistivity, C _t						
250 °C 480 °F		1.00	1.00	1.01	1.01	1.01
500 °C 930 °F		1.01	1.01	1.03	1.03	1.03
800 °C 1470 °F		1.03	1.03	1.05	1.05	1.05
1000 °C 1830 °F		1.04	1.04	1.06	1.06	1.06
1200 °C 2190 °F		1.05	1.04	1.06	1.06	1.06
Coefficient of thermal expansion,	K ⁻¹					
20-100 °C 68-210 °F		–	–	–	–	–
20-250 °C 68-480 °F		11·10 ⁻⁶	11·10 ⁻⁶	11·10 ⁻⁶	11·10 ⁻⁶	11·10 ⁻⁶
20-500 °C 68-930 °F		12·10 ⁻⁶	12·10 ⁻⁶	12·10 ⁻⁶	12·10 ⁻⁶	12·10 ⁻⁶
20-750 °C 68-1380 °F		14·10 ⁻⁶	14·10 ⁻⁶	14·10 ⁻⁶	14·10 ⁻⁶	14·10 ⁻⁶
20-1000 °C 68-1840 °F		15·10 ⁻⁶	15·10 ⁻⁶	15·10 ⁻⁶	15·10 ⁻⁶	15·10 ⁻⁶
Thermal conductivity at 50 °C at 122 °F	W m ⁻¹ K ⁻¹ Btu in ft ² h ⁻¹ °F ⁻¹	11 76	11 76	11 76	11 76	11 76
Specific heat capacity, kJ kg ⁻¹ K ⁻¹ , 20 °C Btu lb ⁻¹ °F ⁻¹ , 68 °F		0.46 0.110	0.46 0.110	0.46 0.110	0.46 0.110	0.46 0.110
Melting point (approx.),	°C °F	1500 2730	1500 2730	1500 2730	1500 2730	1500 2730
Mechanical properties* (approx.)						
Tensile strength,	N mm ⁻² psi	680 98600**	680 110200	725 105200	700 101500	720 104400
Yield point,	N mm ⁻² psi	470 68200**	545 79000	550 79800	500 72500	520 74500
Hardness,	Hv	230	240	230	230	230
Elongation at rupture,	%	20**	20	22	23	20
Tensile strength at 900 °C, at 1650 °F,	N mm ⁻² psi	40 5800	34 4900	34 4900	37 5400	34 4900
Creep strength ***						
at 800 °C, at 1470 °F,	N mm ⁻² psi	8.2 1190	1.2 70	1.2 70	– –	1.2 170
at 1000 °C, at 1830 °F,	N mm ⁻² psi	– –	0.5 70	0.5 70	– –	– –
at 1100 °C, at 2010 °F,	N mm ⁻² psi	– –	– –	– –	0.7 100	– –
at 1200 °C, at 2190 °F,	N mm ⁻² psi	– –	– –	– –	0.3 40	– –
Magnetic properties		1)	1)	1)	1)	1)
Emissivity, fully oxidized condition		0.70	0.70	0.70	0.70	0.70

* The values given apply for sizes of approx. 1.0 mm diameter 0.04 in.

** 4.0 mm 0.16 in. Thinner gauges have higher strength and hardness values while the corresponding values are lower for thicker gauge.

*** Calculated from observed elongation in a Kanthal standard furnace test. 1 % elongation after 1000 hours.

D	NIKROTHAL				NIFETHAL			
	ALKROTHAL	N 80	N 70	N 60	N40	N20	70	52
1300 <i>2370</i>	1100 <i>2010</i>	1200 <i>2190</i>	1250 <i>2280</i>	1150 <i>2100</i>	1100 <i>2010</i>	1050 <i>1920</i>	600 <i>1110</i>	600 <i>1110</i>
22 4.8 Balance –	15 4.3 Balance –	20 – – 80	30 – – 70	15 – Balance 60	20 – Balance 35	24 – Balance 20	– – Balance 72	– – Balance 52
7.25 <i>0.262</i>	7.28 <i>0.263</i>	8.30 <i>0.300</i>	8.10 <i>0.293</i>	8.20 <i>0.296</i>	7.90 <i>0.285</i>	7.80 <i>0.281</i>	8.45 <i>0.305</i>	8.20 <i>0.296</i>
1.35 <i>812</i>	1.25 <i>744</i>	1.09 <i>655</i>	1.18 <i>709</i>	1.11 <i>668</i>	1.04 <i>626</i>	0.95 <i>572</i>	0.20 <i>120</i>	0.43 ⁶⁾ <i>220</i>
1.01 1.03 1.06 1.07 1.08	1.02 1.05 1.10 1.11 –	1.02 1.05 1.04 1.05 1.07	1.02 1.05 1.04 1.05 1.06	1.04 1.08 1.10 1.11 –	1.08 1.15 1.21 1.23 –	1.12 1.21 1.28 1.32 –	2.19 3.66 – – –	1.93 2.77 – – –
– 11·10 ⁻⁶ 12·10 ⁻⁶ 14·10 ⁻⁶ 15·10 ⁻⁶	– 11·10 ⁻⁶ 12·10 ⁻⁶ 14·10 ⁻⁶ 15·10 ⁻⁶	– 15·10 ⁻⁶ 16·10 ⁻⁶ 17·10 ⁻⁶ 18·10 ⁻⁶	– 14·10 ⁻⁶ 15·10 ⁻⁶ 16·10 ⁻⁶ 17·10 ⁻⁶	– 16·10 ⁻⁶ 17·10 ⁻⁶ 18·10 ⁻⁶ 18·10 ⁻⁶	– 16·10 ⁻⁶ 17·10 ⁻⁶ 18·10 ⁻⁶ 19·10 ⁻⁶	– 16·10 ⁻⁶ 17·10 ⁻⁶ 18·10 ⁻⁶ 19·10 ⁻⁶	– – 13·10 ⁻⁶ – 15·10 ⁻⁶	10·10 ⁻⁶ – – – –
11 <i>76</i>	16 <i>110</i>	15 <i>104</i>	14 <i>97</i>	14 <i>97</i>	13 <i>90</i>	13 <i>90</i>	17 <i>120</i>	17 <i>120</i>
0.46 <i>0.110</i>	0.46 <i>0.110</i>	0.46 <i>0.110</i>	0.46 <i>0.110</i>	0.46 <i>0.110</i>	0.50 <i>0.119</i>	0.50 <i>0.119</i>	0.52 <i>0.120</i>	0.50 <i>0.120</i>
1500 <i>2730</i>	1500 <i>2730</i>	1400 <i>2550</i>	1380 <i>2515</i>	1390 <i>2535</i>	1390 <i>2535</i>	1380 <i>2515</i>	1430 <i>2610</i>	1435 <i>2620</i>
670 <i>97200</i>	630 <i>91400</i>	810 <i>117500</i>	820 <i>118900</i>	730 <i>105900</i>	675 <i>97900</i>	675 <i>97900</i>	640 <i>92800</i>	610 <i>88500</i>
485 <i>70300</i>	455 <i>66000</i>	420 <i>60900</i>	430 <i>62400</i>	370 <i>53700</i>	340 <i>49300</i>	335 <i>48600</i>	340 <i>49300</i>	340 <i>49300</i>
230 22 34 <i>4900</i>	220 22 30 <i>4300</i>	180 30 100 <i>14500</i>	185 30 120 <i>17400</i>	180 35 100 <i>14500</i>	180 35 120 <i>17400</i>	160 30 120 <i>17400</i>	– – – –	– 30 – –
1.2 <i>170</i> 0.5 <i>70</i> – – –	1.2 <i>170</i> 1 <i>140</i> – – –	15 <i>2160</i> 4 <i>580</i> – – –	– – – – – –	15 <i>2160</i> 4 <i>580</i> – – –	20 <i>2900</i> 4 <i>580</i> – – –	20 <i>2900</i> 4 <i>580</i> – – –	– – – – – –	– – – – – –
1) 0.70	1) 0.70	2) 0.88	2) 0.88	3) 0.88	2) 0.88	2) 0.88	4) 0.88	5) 0.88

1) Magnetic (Curie point approx. 600 °C 1100 °F)

2) Non-magnetic

3) Slightly magnetic

4) Magnetic up to °C/°F (Curie point) 610/1130

5) Magnetic up to °C/°F (Curie point) 530/990

6) ± 10 %

		CUPRO- THAL 49	MANGA- NINA 43	CUPROTHAL			
				30	15	10	05
Nominal composition, %	Ni	44	4	23	11	6	2
	Cu	Balance	Balance	Balance	Balance	Balance	Balance
	Fe + Other	1 Mn	11 Mn	1.5 Mn			
Density,	g/cm ³	8.9	8.4	8.9	8.9	8.9	8.9
	lb/in ³	0.321	0.3+2	0.321	0.321	0.321	0.321
Resistivity at 20 °C, at 68 °F	Ω mm ² m ⁻¹	0.49	0.43	0.30	0.15	0.10	0.05
	Ω/cm ²	295	259	180	90	60	30
Temperature coefficient of resistance, Km x 10 ⁻⁶ /°C		±20/±60	±15	250	400	700	1300
Temperatur range,	°C	-55-150	15-35	20-105	20-105	20-105	20-105
Linear expansion coefficient							
	Coefficient x 10 ⁻⁶ /°C	14	18	16	16	16	16.5
Temperatur range,	°C	20-100	20-100	20-100	20-100	20-100	20-100
Thermal conductivity at 50 °C, at 122 °F	Wm ⁻¹ K ⁻¹	21	22	35	60	90	130
	Btu in ft ² h ⁻¹ °F ⁻¹	146	153	243	460	624	901
Specific heat capacity, kJ kg ⁻¹ K ⁻¹ , 20 °C Btu lb ⁻¹ °F ⁻¹ , 68 °F		0.41	0.41	0.37	0.38	0.38	0.38
		0.098	0.098	0.088	0.091	0.091	0.091
Melting point (approx.),	°C	1280	1020	1150	1100	1095	1090
	°F	2336	1868	2102	2012	2003	1994
Mechanical properties* (approx.)							
Tensile strength,	N mm ⁻² , min.	420	290	340	250	230	220
	psi, min.	60900	42050	49300	36200	33350	31900
	N mm ⁻² , max.	690	640	690	540	680	440
	psi, max.	100100	92800	100100	78300	98600	63800
Elongation at rupture,	%	30	30	30	30	30	30
Magnetic properties		Non-magnetic					

3. Stranded Resistance Heating Wire

Recognising the need for more precisely controlled stranded wire within the cable industry and working closely with our cable customers, Kanthal have developed a range of stranded resistance wires in the well known NIKROTHAL, KANTHAL and Nickel alloys.

These alloys possess the optimum properties for high performance at elevated temperatures and in other adverse conditions where reliability and quality is of paramount consideration.



3

Alloy	Nominal composition, %					Resistivity at 20°C Ω mm ² m ⁻¹	Max. temp *) °C
	Ni	Cr	Fe	Al	Oth.		
NIKROTHAL 80	80	20				1.09	1200
NIKROTHAL 60	60	16	Bal.			1.11	1150
KANTHAL D		22	Bal.	4.8		1.35	1300
KANTHAL AF		22	Bal.	5.3		1.39	1300
NICKEL	99.2					0.09	
Ni Mn2%	98				2 Mn	0.11	

•) Values given apply for sizes approx. 1.0 mm

Strand diameter

Nominal diameter to be determined from single-end wire diameters, which have to meet resistance requirements. Resistance generally takes priority over diameter. The calculation is:
Strand normal diameter = single-end diameter x F

- F=3 for 7-strand
- F=5 for 19-strand true concentric
- F=7 for 37-strand true concentric

Size range

Up to 37 wires (ends) of diameter between 0.20-0.85 mm.



True Concentric

Successive layers have different lay directions and lay length.

Standard Stocked Material

Strand size mm	Alloy	Strand diameter nominal, mm	Strand resistance Ω/m	Meter per Kilo (approx.)
19 x 0.544	NIKROTHAL 80		0.2344-0.2579	26
19 x 0.523	NIKROTHAL 80	2.67	0.2886 max.	30
KW 0.574				
37 x 0.385	NIKROTHAL 80	2.76	0.276 max.	26
KW 0.45				
19 x 0.574	NIKROTHAL 80	2.87		25
19 x 0.523	NIKROTHAL 60		0.297 max.	30
KW 0.574				
19 x 0.574	Nickel	2.87	0.0243 max.	21
19 x 0.574	Ni Mn2%		0.0247 max.	22
19 x 0.610	Ni Mn2%		0.0208 max.	19
KW 0.71				

KW = King Wire

The Kanthal plant and head office in Hallstahammar, Sweden



Flexible Terminations for Industrial Applications

	Flex Size V. Small	Small	Medium	Large	X. Large
Flex Ø, mm	2.3	3.75	4.2	6.7	9.3
CSA, mm ²	3.18	8.40	10.78	21.65	38.48
Strands	7 x 0.76 mm	19 x 0.75 mm	19 x 0.85 mm	49 x 0.75 mm	49 x 1.00 mm
Weight, gram/m	26.24	70	86	184	325
Current, A (low temp. <400 °C)	7	15	22	44	77
Current, A (high temp. >400 °C)	5	15	20	30	45
Ω/m, cold	0.347	0.106	0.102	0.050	0.028

CSA = Cross Sectional Area



4. Thin Wide Strip

Wide and very thin strip has been introduced as an alternative to flattened wire, ribbon, to offer a wider choice of widths than what can be offered via wire flattening.

Kanthal has the ability to supply thin wide resistance strip in the thickness range 0,04 to 0,1 mm in widths up to 275 mm produced through rolling and slitting to dimension.

The alloys available in this product form are primarily the high performing FeCrAl types, like KANTHAL AF, as specified in the technical section of this handbook.

For a material with very high surface to volume ratio such as this thin strip, no standard guidelines for maximum temperature and lifetime are applicable because of the big influence from the chosen design. We advice that everyone considering using this product form should contact Kanthal for in depth discussions before finalising dimensions and design of an application. Kanthal offers advice and technical support regarding choice of dimensions etc.

Thin strip – vertically applied.





Thin strip heating elements for glass top hot plates.



5. Design Factors

Operating Life

The life of the resistance heating alloy is dependent on a number of factors, among the most important are:

- Temperature
- Temperature cycling
- Contamination
- Alloy composition
- Trace elements and impurities
- Wire diameter
- Surface condition
- Atmosphere
- Mechanical stress
- Method of regulation

Since these are unique for each application it is difficult to give general guidelines of life expectations. Recommendations on some of the important design factors are given below.

Table 1

Relative Durability Values in %, KANTHAL and NIKROTHAL Alloys (ASTM-test wire 0.7 mm 0.028 in)

	1100 °C 2010 °F	1200 °C 2190 °F	1300 °C 2370 °F
KANTHAL A-1	340	100	30
KANTHAL AF	465	120	30
KANTHAL AE	550	120	30
KANTHAL D	250	75	25
NIKROTHAL 80	120	25	-
NIKROTHAL 60	95	25	-
NIKROTHAL 40	40	15	-

Oxidation properties

When heated, resistance-heating alloys form an oxide layer on their surface, which slows down further oxidation of the material. To accomplish this function the oxide layer must be dense and resist the diffusion of gases as well as metal ions. It must also be thin and adhere to the metal under temperature fluctuations.

The protective oxide layer on KANTHAL alloys formed at temperatures above 1000 °C 1830 °F consists mainly of alumina (Al₂O₃). The colour is light grey, while at lower temperatures (under 1000 °C, 1830 °F) the oxide colour becomes darker. The alumina layer has excellent electrical insulating properties and good chemical resistance to most compounds.

The oxide formed on NIKROTHAL alloys consists mainly of chromium oxide (Cr₂O₃). The colour is dark and the electrical insulating properties inferior to those of alumina.

The oxide layer on NIKROTHAL alloys spalls and evaporates more easily than the tighter oxide layer that is formed on the KANTHAL alloys.

Results of several life tests according to ASTM B 78 (modified) are given in Table 1 for KANTHAL and NIKROTHAL alloys. In the table, the durability of KANTHAL A-1 wire at 1200 °C 2190 °F is set at 100 %, and the durability of the other alloys is related to that figure.

Corrosion Resistance

Corrosive or potentially corrosive constituents can considerably shorten wire life. Perspiring hands, mounting or supporting materials or contamination can cause corrosion.

Steam

Steam shortens the wire life. This effect is more pronounced on NIKROTHAL alloys than on KANTHAL alloys.

Halogens

Halogens (fluorine, chlorine, bromine and iodine) severely attack all high-temperature alloys at fairly low temperatures.

Sulphur

In sulphurous atmospheres KANTHAL alloys have considerably better durability than nickel-base alloys. KANTHAL is particularly stable in oxidising gases containing sulphur, while reducing gases with a sulphur content diminish its service life. NIKROTHAL alloys are sensitive to sulphur.

Salts and oxides

The salts of alkaline metals, boron compounds, etc. in high concentrations and are harmful to heating alloys.

Metals

Some molten metals, such as zinc, brass, aluminium and copper, react with the resistance alloys. The elements should therefore be protected from splashes of molten metals.

Ceramic support material

Special attention must be paid to the ceramic supports that come in direct contact with the heating wire. Firebricks for wire support should have an alumina content of at least 45 %. In high-temperature applications, the use of sillimanite and high-alumina firebricks is often recommended. The free silica (uncombined quartz) content should be held low. Iron oxide lowers the melting point of the ceramics. Water glass as a binder in cements must be avoided.

Embedding compounds

Most embedding compounds including ceramic fibres are suitable for KANTHAL and NIKROTHAL if composed of alumina, alumina-silicate, magnesia or zirconia.

Maximum Temperature per Wire Size

The table below gives maximum wire temperatures as a function of wire diameter when operating in air.

Table 2
Maximum Permissible Temperature as a Function of Wire Size

	Diameter, mm (in):			
	0.15-0.4 (0.0059-0.0157)	0.41-0.95 (0.0061-0.0374)	1.0-3.0 (0.039-0.118)	>3.0 (>0.118)
	°C	°C	°C	°C
	°F	°F	°F	°F
KANTHAL AF	900-1100 <i>1650-2010</i>	1100-1225 <i>2010-2240</i>	1225-1275 <i>2240-2330</i>	1300 <i>2370</i>
KANTHAL A	925-1050 <i>1700-1920</i>	1050-1175 <i>1920-2150</i>	1175-1250 <i>2150-2300</i>	1350 <i>2460</i>
KANTHAL AE	950-1150 <i>1740-2100</i>	1150-1225 <i>2100-2240</i>	1225-1250 <i>2240-2300</i>	1300 <i>2370</i>
KANTHAL D	925-1025 <i>1700-1880</i>	1025-1100 <i>1880-2010</i>	1100-1200 <i>2010-2190</i>	1300 <i>2370</i>
NIKROTHAL 80	925-1000 <i>1700-1830</i>	1000-1075 <i>1830-1970</i>	1075-1150 <i>1970-2100</i>	1200 <i>2190</i>
NIKROTHAL 60	900-950 <i>1650-1740</i>	950-1000 <i>1740-1830</i>	1000-1075 <i>1830-1970</i>	1150 <i>2100</i>
NIKROTHAL 40	900-950 <i>1650-1740</i>	950-1000 <i>1740-1830</i>	1000-1050 <i>1830-1920</i>	1100 <i>2010</i>

6. Element types and heating applications

The Embedded Element Type

The wire in the embedded element type is completely surrounded by solid or granular insulating material.

Metal Sheathed Tubular Elements

KANTHAL D is generally the best heating wire for tube temperatures below 700 °C 1290 °F and NIKROTHAL 80 for temperatures above.

To use KANTHAL instead of NiCr gives the following advantages:

- Lower wire weight by some 20-30 % at the same wire dimension
- More even temperature along the element and lower maximum wire temperature. This means that the element can be charged higher for a short time - important when there is a risk of dry boiling
- Closer tolerances of rating. Rating and temperature remains more constant since the resistivity in hot state does not change as much as for NiCr
- Longer life at high surface loads. The element life is also easier forecasted
- KANTHAL is easier to manufacture when high resistance per length is needed, since a thicker wire can be used
- Less sensitive to corrosion attacks

The Supported Element Type

The wire, normally in spiral form, is situated on the surface, in a groove or a hole of the electrical insulating material.

KANTHAL AE, KANTHAL AF and NIKROTHAL 80 are generally the best materials.

In order to avoid deformations on horizontal coils, the wire temperature should not exceed the values given in Figure 3.

The Suspended Element Type

The wire is suspended freely between insulated points and is exposed to the mechanical stress caused by its own weight, its own spring force and in some cases also from the forces of an external spring.

NIKROTHAL 80, NIKROTHAL 60, KANTHAL D and KANTHAL AF are the best materials.

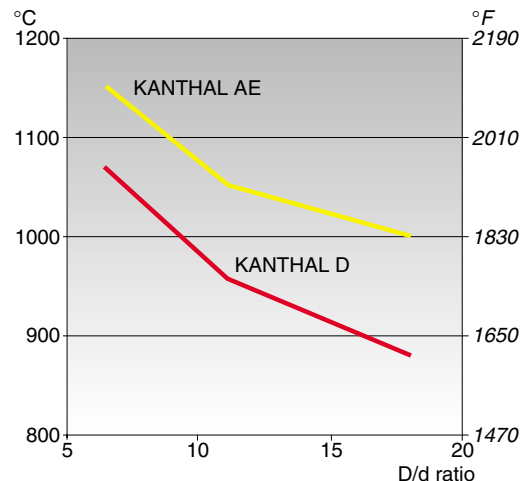
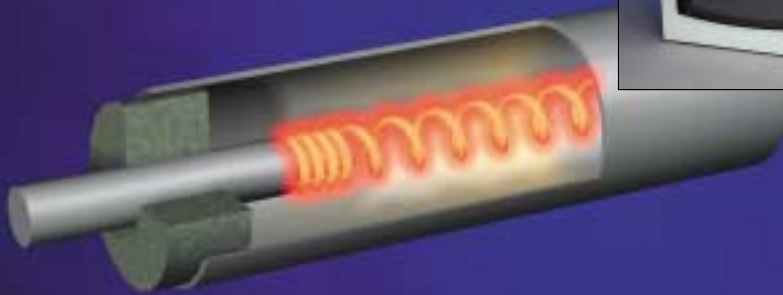

Figure 3. Permissible D/d ratios as a function of wire temperature in supported spiral elements.

Embedded Elements

Metal Sheathed Tubular Elements



Characteristics

The heating coil is insulated from the encasing metallic tube by granular material (MgO). The tube is compressed to a round, oval or triangular shape. Terminals may be at either end or at one end of the element (cartridge type).

Recommended alloy

KANTHAL D in elements with sheath temperature $<700^{\circ}\text{C}$ $<1290^{\circ}\text{F}$.

NIKROTHAL 80 in elements with sheath temperature $>700^{\circ}\text{C}$ $>1290^{\circ}\text{F}$.

Surface load

Wire: Normally 2-4 times the element surface load (wire surface load is not so critical in this element type).

Element: $2-25 \text{ W/cm}^2$ $13-161 \text{ W/in}^2$

Typical applications

Very common element, for example: Cooking: Hot plates, domestic ovens, grills, toaster ovens, frying pans, deep fryers, rice cookers.

Water and beverage: Boilers, immersion heaters, water kettles, coffee makers, dish washers, washing machines.

Space heating: Radiators, storage heaters.

Others: Irons, air heaters, oil heaters, glow plugs, sauna heaters.



Embedded Elements

Elements Embedded in Ceramics

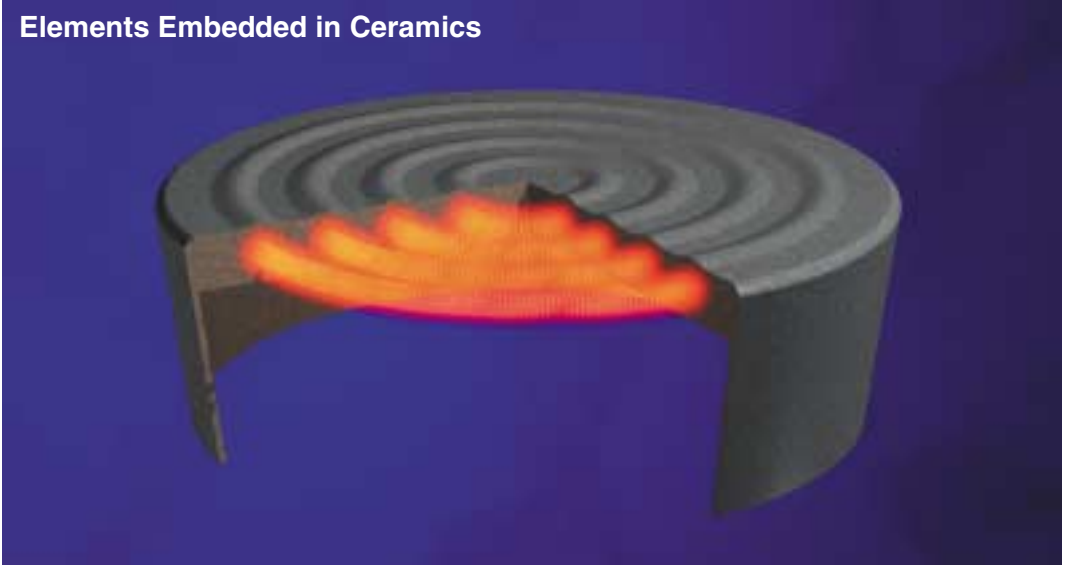

Characteristics

Heating coil is embedded in green ceramics (subsequently fired), or cemented in grooves in ceramic bodies.

Recommended alloy

KANTHAL A for high temperature firing.
KANTHAL D for other applications.

Surface load

Wire: 5-10 W/cm² 30-60 W/in²

Typical applications

Panel heaters, IR heaters, warming plates, irons, ceramic pots.



Embedded Elements

Coils in grooved Metal Plates

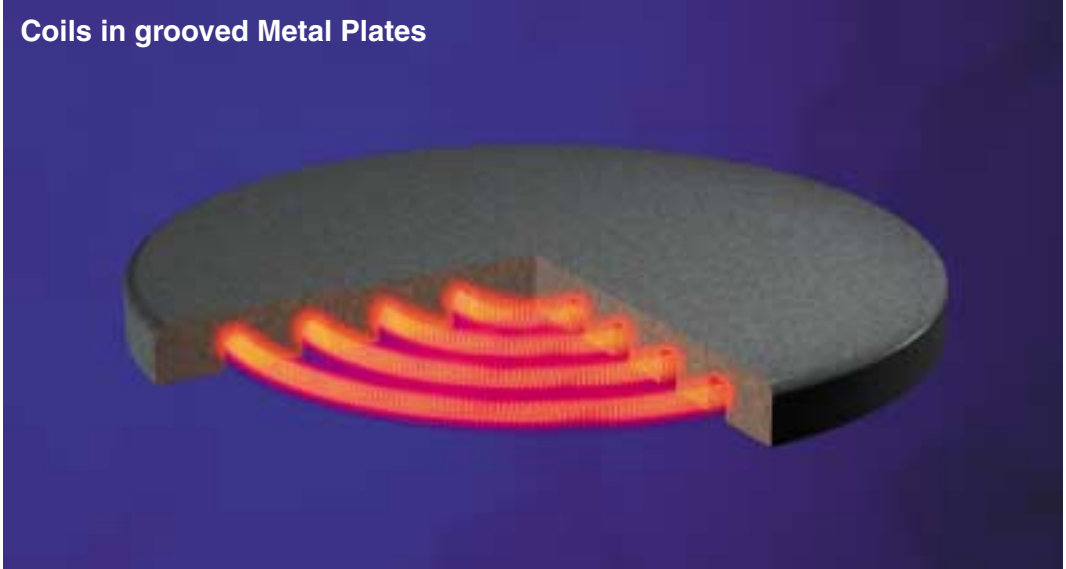

Characteristics

Heating coil and insulating powder are pressed into grooves of a metal plate.

Recommended alloy

KANTHAL D

Surface load

Wire:

4-20 W/cm² 25-130 W/in²

Typical applications

Cast iron plates; also, irons, warming plates, kettles, domestic ovens.



Embedded Elements

Cartridge Elements, Powder filled

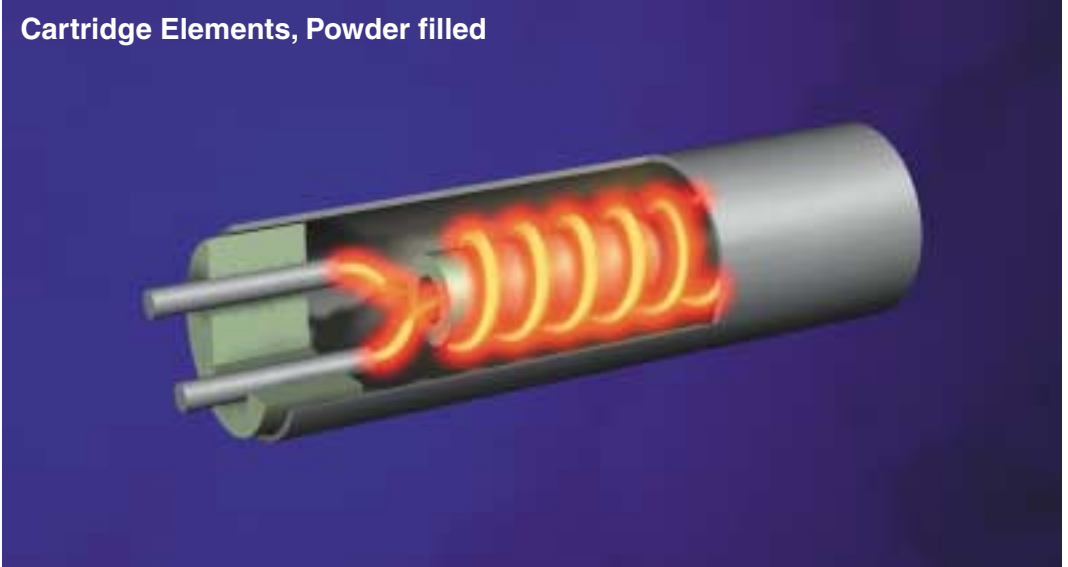

Characteristics

Straight wire or coil is wound on a threaded ceramic body and insulated by granular insulating material (MgO) from enveloping metal tube. Terminals are at one end of the element. Elements are compressed when high-loaded.

Recommended alloy

NIKROTHAL 80 in straight wire elements.

KANTHAL D in coiled wire elements.

Surface load

On tube:

10-25 W/cm^2 65-160 W/in^2 for elements with straight wire.

Other types: about 5 W/cm^2 30 W/in^2 .

Typical applications

Metal dies, plates, etc., refrigerators.



Embedded Elements

Heating Cables and Rope Heaters



Characteristics

Wire is wound on a fibreglass core and insulated by PVC or silicone rubber (higher temperatures). Fibreglass insulation permits even higher temperatures. Heating cables with straight or stranded wires, sometimes enclosed in aluminium tube, also occur.

Recommended alloy

KANTHAL D	CUPROTHAL 30
NIKROTHAL 40	CUPROTHAL 10
NIKROTHAL 80	CUPROTHAL 49

Surface load

Wire:

$<1 \text{ W/cm}^2$ $<6 \text{ W/in}^2$ on wire for PVC and silicone rubber.

$2\text{-}5 \text{ W/cm}^2$ $13\text{-}30 \text{ W/in}^2$ for fibreglass insulation.

Typical applications

Defrosting and de-icing elements, electric blankets and pads, car seats, baseboard heaters, floor heating.



Embedded Elements

Mica Elements

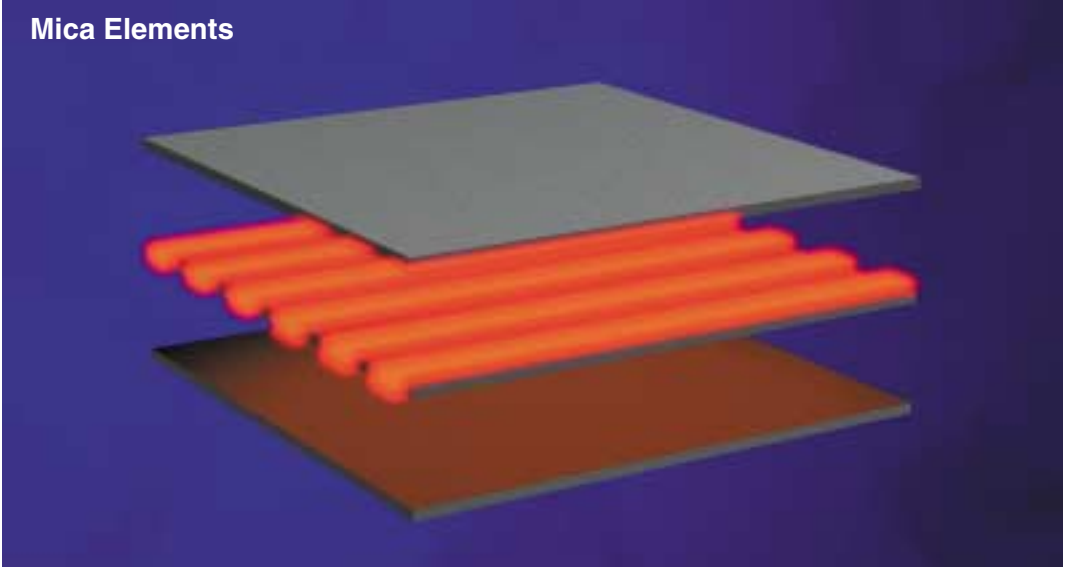

Characteristics

Resistance ribbon or wire is wound on mica sheet or tube and insulated by mica. Elements are often encapsulated in steel sheaths.

Recommended alloy

KANTHAL D
NIKROTHAL 80

Surface load

Wire:

$2-10 \text{ W/cm}^2$ $13-65 \text{ W/in}^2$

Typical applications

Irons, ironing machines, water heaters, plastic moulding dies, soldering irons.



Supported Elements

Ceramic Cartridge Elements

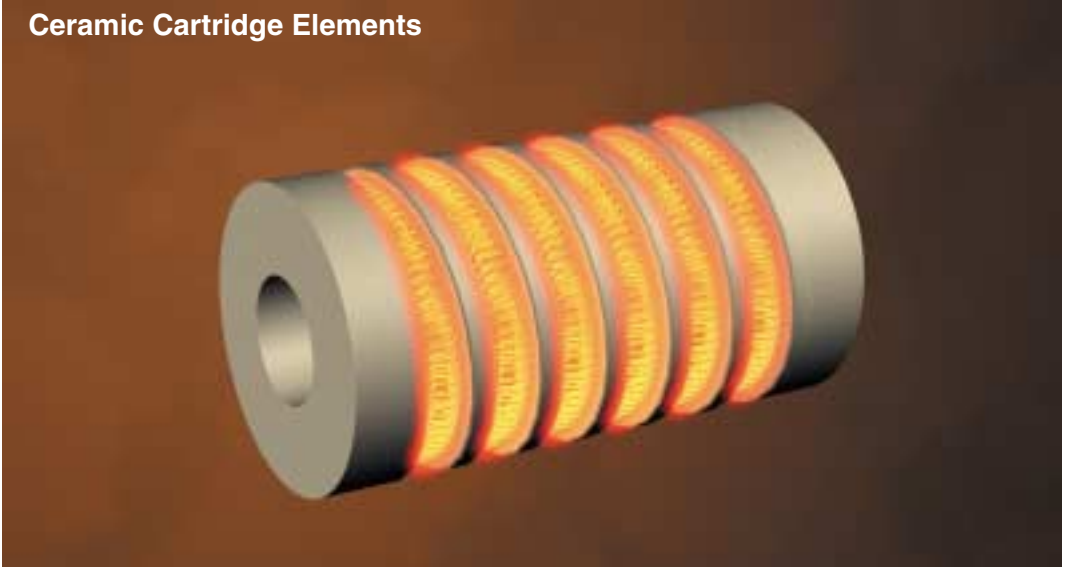

Characteristics

Most common design consists of round ceramic bodies with longitudinal holes or grooves for heating coil. Elements are often in metallic tube with terminals at one end.

Often provisions are made to avoid excessive sagging of the coil when the element is operating vertically.

Recommended alloy

KANTHAL A or D for horizontally operating coils.

NIKROTHAL 80 (usually) for long vertically situated coils when sagging is a problem.

Surface load

Wire:

3-6 W/cm² 20-40 W/in²

Element:

2-5 W/cm² 13-32 W/in²

Typical applications

Liquid heating, storage heaters.



Supported Elements

Other ceramic elements

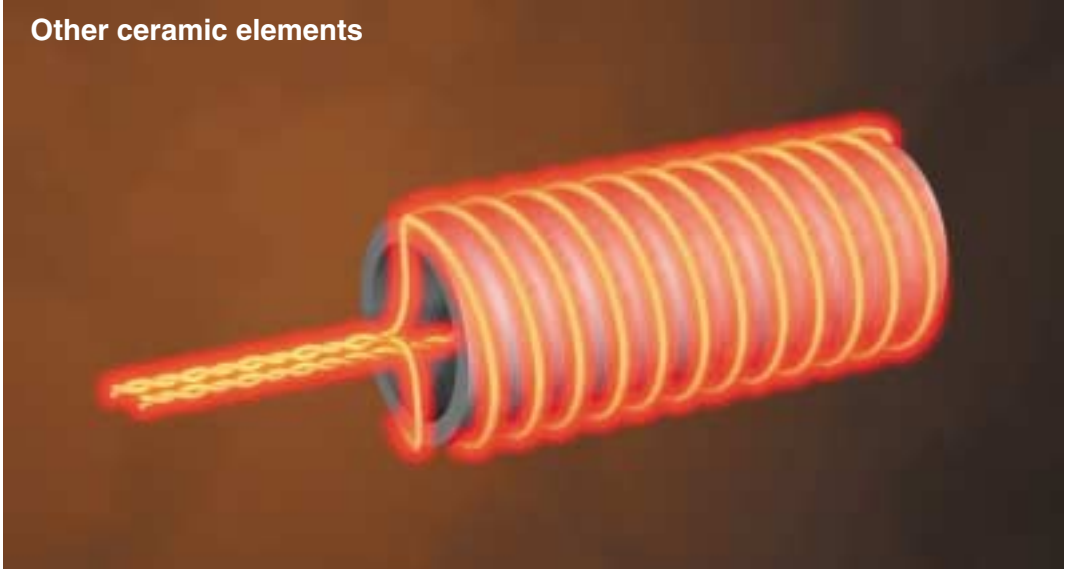

Characteristics

Coiled and straight wire is located on smooth ceramic tube or in grooves or holes of ceramic bodies of various shapes (plates, tubes, rods, cylinders, etc.).

Recommended alloy

KANTHAL A, AF and D.
NIKROTHAL 80 (for pencil bars).

Surface load

Wire:
 $3-9 \text{ W/cm}^2$ $20-60 \text{ W/in}^2$

Typical applications

Boiling plates, air guns, hobby kilns, radiators.



Supported Elements

Quartz Tube Heaters

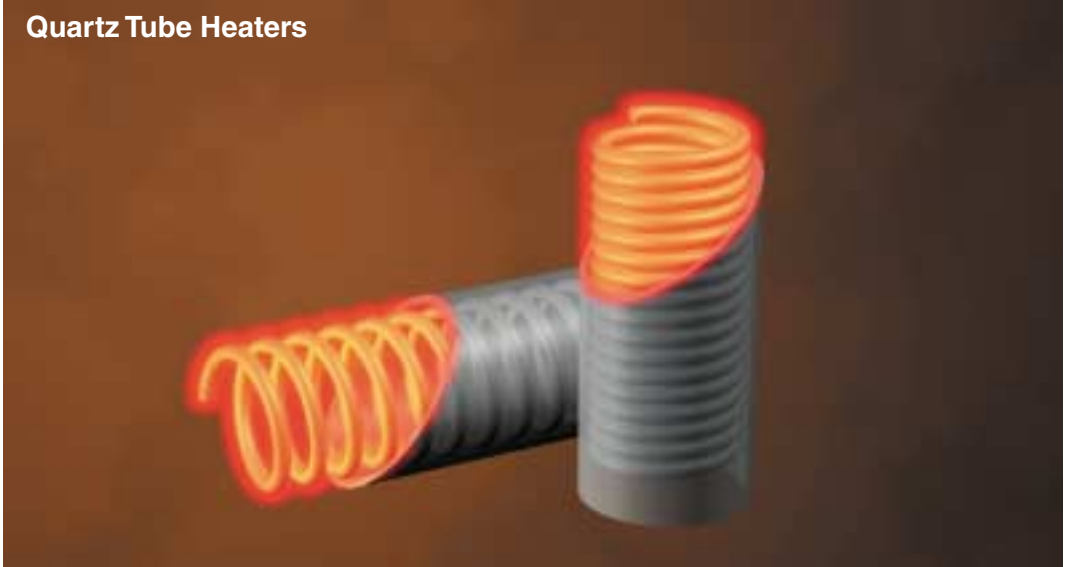

Characteristics

Heating coil is placed inside quartz tube (or tube of glass ceramic). When the element is operating vertically or at an angle, the coil should be tight-wound and pre-oxidized. For horizontal use, the relative pitch is 1.2-2.0.

Recommended alloy

KANTHAL AE, AF, A and D.

Surface load

Wire:

2-8 W/cm² 13-52 W/in²

Element:

4-8 W/cm² 26-52 W/in²

Typical applications

Space heating, toasters, toaster ovens, grills, industrial infrared dryers etc.



Supported Elements

Elements on moulded ceramic fibre



Characteristics

Heating coil rests on moulded ceramic fibre plate, with or without grooves. Coils are cemented or stapled at intervals, or pressed into ribs on this surface.

Thin wide strip, normally in corrugated shape, is more and more common as an alternative to coiled wire. Ribbon has also been used.

Recommended alloy

KANTHAL AE or AF.

Surface load

Wire:

$<10 \text{ W/cm}^2 < 65 \text{ W/in}^2$

Ribbon:

$4-6 \text{ W/cm}^2 \text{ } 25-40 \text{ W/in}^2$

Typical applications

Boiling plates with ceramic hobs (glass top hot plates).



Supported Elements

Bead insulated coils or stranded wire

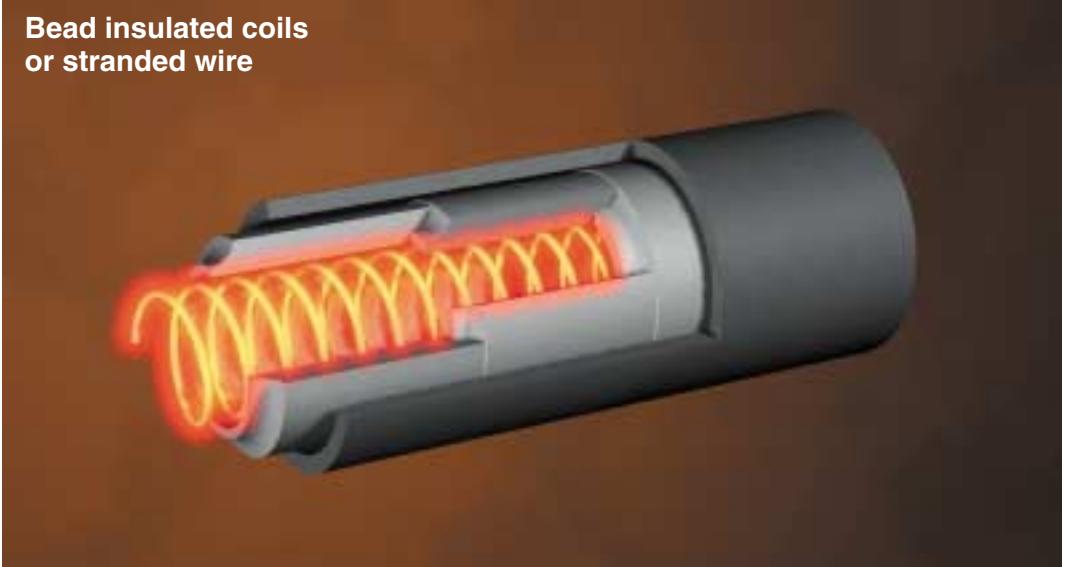

Characteristics

Heating coil, or stranded wire, is insulated by ceramic beads. With beads having two holes heating mats are made.

Recommended alloy

KANTHAL D, NIKROTHAL 80 (for panel heaters).

Surface load

Wire:

1-8 W/cm² 6.5-52 W/in²

Typical applications

Mats for in-situ annealing of welded parts, panel heaters, waffle irons, domestic ovens, water heater.



Supported Elements

String Elements

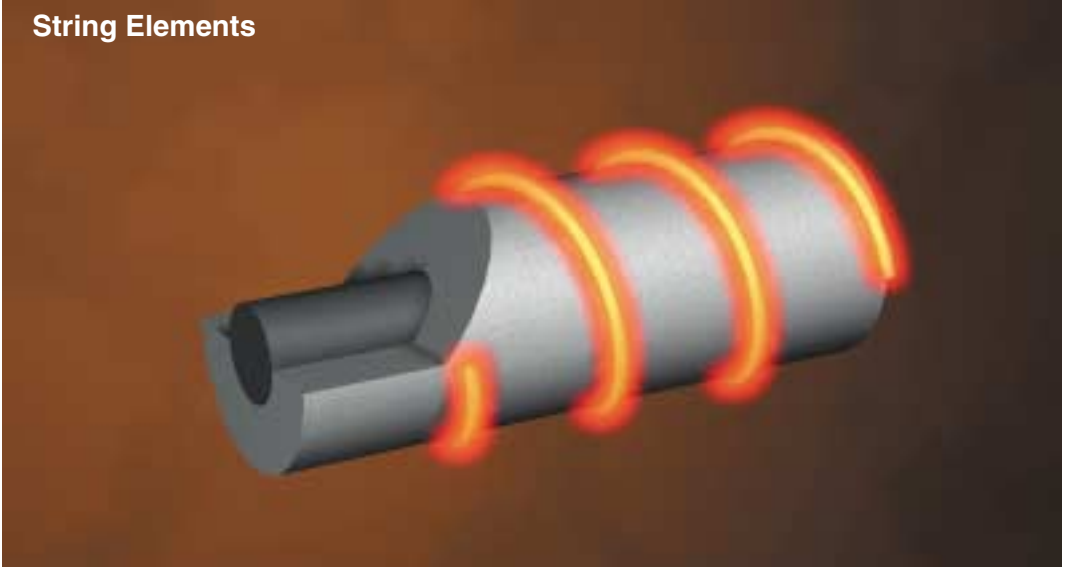

Characteristics

Heating wire wound on insulated steel wire (approx. 2 mm *0.008 in*) or fibre glass cord.

Recommended alloy

KANTHAL D.

Surface load

Wire:

$<10 \text{ W/cm}^2$ $<65 \text{ W/in}^2$

Typical applications

Stationary hair dryers.



Suspended Elements

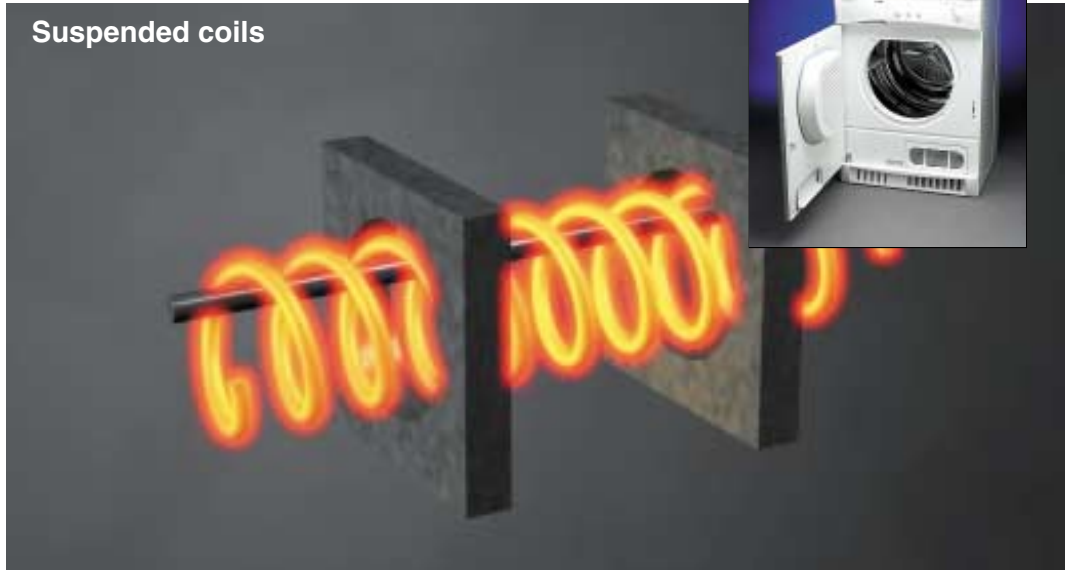

Suspended coils

Characteristics

Wire coil is supported at intervals, e.g. by ceramic holders. Fibreglass cord is often placed inside coil to prevent the coil from falling down in case of element failure.

Recommended alloy

NIKROTHAL 80 and NIKROTHAL 60

KANTHAL D and AF (mainly for wire temperatures below 600°C 1110°F , where sagging is no problem).

Surface load

Wire:

7-8 W/cm^2 45-50 W/in^2 in forced air;

3-4 W/cm^2 20-25 W/in^2 in natural convection.

Typical applications

Air heaters such as:

laundry dryers, hair dryers, fan heaters, land dryers.



Suspended Elements

Suspended straight wires and ribbons

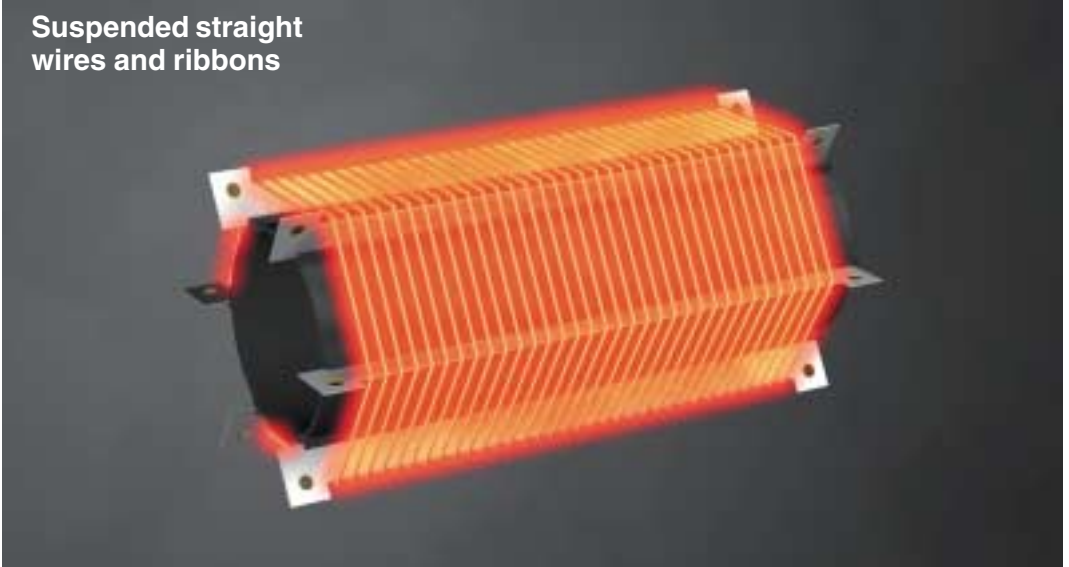

Characteristics

Wire or ribbon may have elastic or fixed suspension.

Elastic: Wire kept straight by springs when heated.

Fixed: Operating temperature is lower and low thermal expansion is advantageous.

Recommended alloy

KANTHAL A and AF (low thermal expansion)

NIKROTHAL 80

Surface load

Wire:

4-12 W/cm² 25-77 W/in²

Typical applications

Radiators, toasters, convection heaters, hair dryers.



Suspended Elements

Open Mica Elements

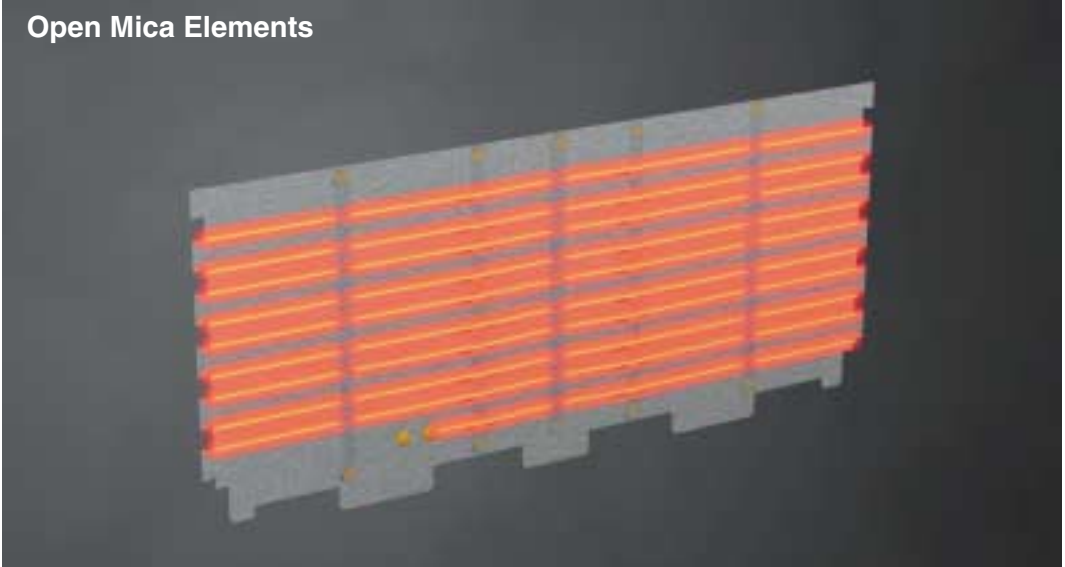

Characteristics

Straight or corrugated heating wire is wound on one or both sides of a mica sheet or separated mica strips. Ribbons are frequently used in this application.

Recommended alloy

NIKROTHAL 80, NIKROTHAL 60, KANTHAL D and AE.

Surface load

Wire:

$4-7 \text{ W/cm}^2$ $25-45 \text{ W/in}^2$

For toasters:

$< 13 \text{ W/cm}^2$ $< 26-52 \text{ W/in}^2$ for wire-wound elements

Typical applications

Toasters; also, convection heating, low-watt aquarium heaters.



Suspended Elements

Zig-zag Elements

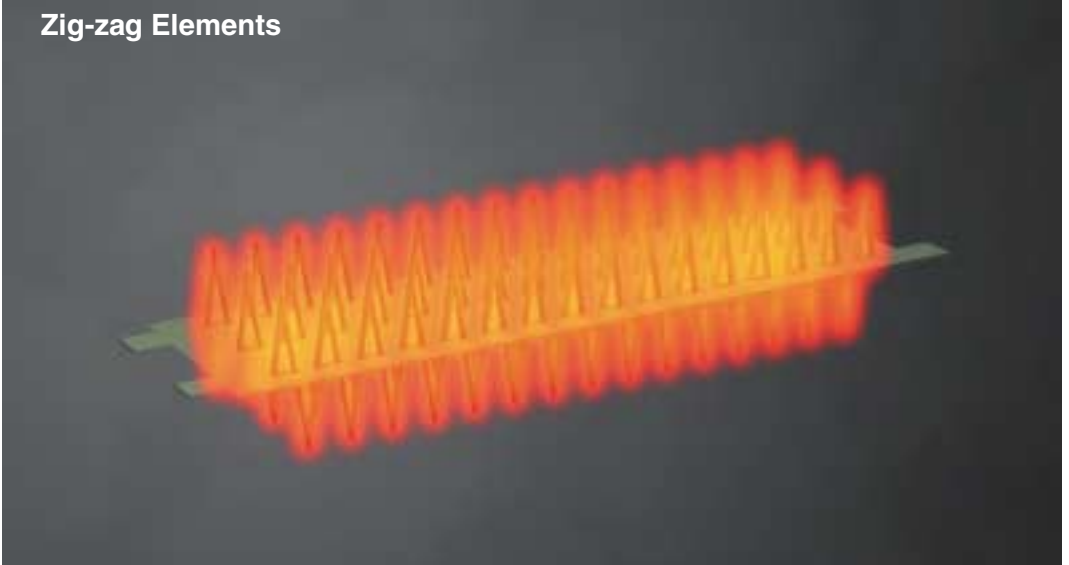

Characteristics

Deep-corrugated ribbon is supported by mica sheets. Also radial shape.

Recommended alloy

KANTHAL D, AF and NIKROTHAL 40

Surface load

Wire:

9 W/cm^2 60 W/in^2

Typical applications

Fan heaters, convection heating.



Suspended Elements

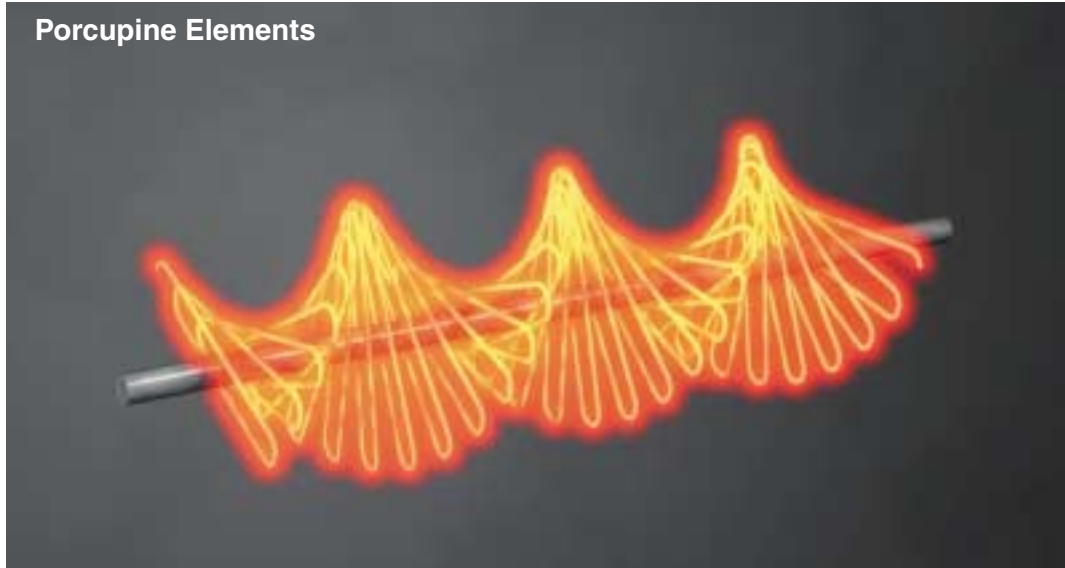

Characteristics

Heating conductor consists of hairpin- shaped wire bends protruding in all directions, with hole in centre. Element is supported by central insulated rod or insulating tube around its circumference.

Recommended alloy

KANTHAL D, AF
NIKROTHAL 80

Surface load

Wire:
 4 W/cm^2 25 W/in^2 in natural convection,
 $<12\text{ W/cm}^2$ 75 W/in^2 in forced convection.

Typical applications

Hot air guns, radiators, convectors, tumble dryers, domestic ovens with forced convection.

Suspended Elements

Coils immersed
in water

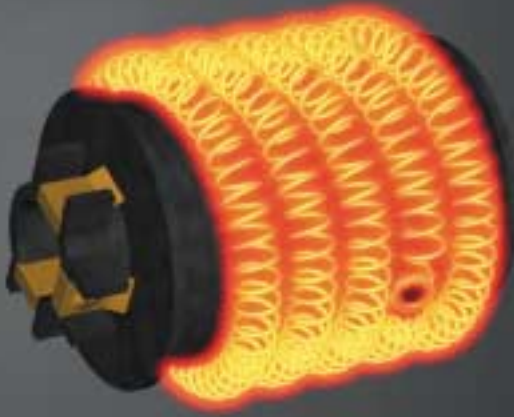

Characteristics

6

Wire coils operating directly in water.

Recommended alloy

KANTHAL D and AF NIKROTHAL 80.

Surface load

Wire:

Depending on water velocity, 20-60 W/cm² 130-390 W/in² (even higher figures occur.)

Typical applications

Instantaneous tap water and shower heaters, steam generators.



7. Standard Tolerances

Standard tolerances for wire and ribbon are given below. Size tolerances do not apply to material manufactured to resistance tolerances and vice-versa.

Tolerances on electrical resistance

Resistance of wire at 20 °C

Diameter ≤ 0.127 mm *0.0048 in ± 8 %*.
 All dimensions >0.127 mm *0.0048 in ± 5 %*.

Resistance of ribbon

For cold rolled strips and ribbon, all widths and thickness' ± 5%.

Tolerances on dimensions

Tolerances on diameter of wire according to the EN 10 218-2 T4 standard

Wire size, mm	Max deviation from nominal value, mm	Max ovality, mm	Wire size, In	Max deviation from nominal value, in	Max ovality, in
d	Tol = ±0.015·√d	Tol = ±0.015·√d	d	Tol = ±0.002975·√d	Tol = ±0.002975·√d

Max ovality = a – b

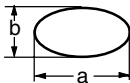

Tolerances on dimensions of cold rolled ribbon

Ribbon is normally specified with a resistance tolerance. If requested, dimension tolerance on width can be applied as below.

Width mm in	Thickness mm in		
	0.07-0.2 <i>0.0028-0.008</i>	0.2-0.5 <i>0.008-0.020</i>	0.5-0.8 <i>0.020-0.031</i>
0.5-1.5 <i>0.020-0.059</i>	+0.02 -0.04 <i>+0.0001 -0.0016</i>	+0.01 -0.03 <i>+0.0004 -0.0012</i>	
1.5-2.5 <i>0.059-0.098</i>	+0.04 -0.07 <i>+0.0016 -0.0028</i>	+0.03 -0.04 <i>+0.0012 -0.0016</i>	+0.02 -0.04 <i>+0.0001 -0.0016</i>
2.5-4.0 <i>0.098-0.159</i>		±0.08 <i>±0.0031</i>	+0.12 <i>+0.0047</i>

8. Delivery Forms

In order to avoid transport damage all goods are carefully packed in card board boxes or wooden cases, with suitable internal protection.

Resistance Heating alloys (KANTHAL, ALKROTHAL, NIKROTHAL, NIFETHAL 70 and 52)

Wire

Wire of ≤ 1.63 mm is delivered on spools, such as shown in the figure. Only one length of wire is wound on each spool. Wire sizes between 0.40 and 1.63 mm can be

supplied in round Pail Packs (drums) such as shown in the table below. Wire sizes > 1.65 mm is normally supplied in coils with an inner diameter of approx. 500-600 mm.

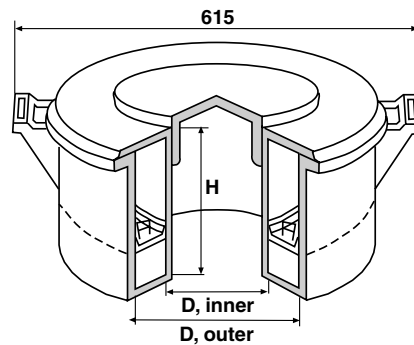
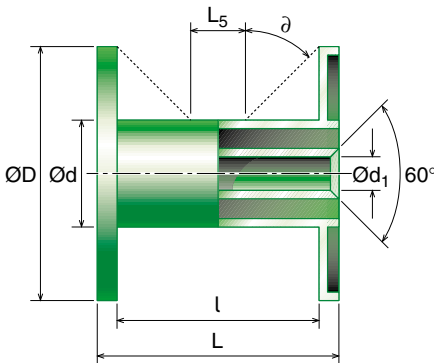

Types of Wire Spools

Spool No.	Tare g	Spool measurements, mm					Wire dia. mm	Capacity approx. kg
		D	d	l	d1	L		
B 1	100	75	40	100	16	120	0.10-0.19	1
B 2	115	90	40	100	16	120	0.20-0.24	2
B 4	180	120	50	100	16	120	0.25-1.00	4
K 200	600	200	125	160	36	200	0.16-1.20	10
K 250	1050	250	160	160	36	200	0.30-1.63	20
K 355	1850	355	224	160	36	200	0.50-1.63	40

Types of Wire Pails (Drum Pack)

Pail No.	Tare g	Pail measurements, mm				Material	Wire dia. mm	Capacity approx. kg
		D, outer	D, inner	height				
P50	2600	508	330	150	Plastic	0.40-1.63	33	
P100	3500	508	330	250	Plastic	0.40-1.63	50	
P200	8500	500	300	520	Cardboard	0.80-1.63	160-240	
P350	10000	500	300	820	Cardboard	0.80-1.63	250-400	

Thin wide strip

Standard delivery is in coil form on inner core.

For full width material the core is a recyclable steel tube with inner diameter 400 mm.

For narrow slit widths the core is made of hard paper or plastic with inner diameter 200-400 mm depending on strip width and request.

On special demand, narrow slit strip up to 10 mm can be delivered pitch wound on a special spool.

Coil weight or strip lengths are subject to special agreements.

Ribbon

Ribbon is normally supplied on K 125 spools. Sizes of section $\geq 0.3\text{mm}^2$ are wound on K 100 spools. If requested, the smallest sizes can be supplied on K 80 spools.

Rods

Available shaved or un-shaved depending on the alloy.

Types of Ribbon Spools

Spool No.	Tare g	Spool measurements, mm					Capacity, kg	
		D	d	l	d1	L	KANTHAL	NIKROTHAL
K 80	70	80	50	64	16	80	0.7	0.8
K 100	125	100	63	80	16	100	1.5	1.9
K 125	200	125	80	100	16	125	3	3.5
K 200	600	200	125	160	36	200	10	11

Resistance alloys (CUPROTHAL 49, 30, 15, 10, 5 and MANGANINA 43)

The wire is normally packed as shown below. Wire and ribbon can also be specially packed to individual requirements. To provide additional protection to the materials, spools are wrapped with plastic film or closed in plastic boxes.

Wire

Wire up to 1.40 mm is available on spools. At the request of the customer, wire can also be supplied in annular drums as detailed below. The figure shows the drum without handles.

Wire dimensions from 1.40 to 8.0 are available in coils. The inner diameter of the coil is 350 to 650 mm depending on the alloy type and the diameter.

Wire from 2.00 mm up to 8.0 mm can be straightened in random or fixed lengths. Straight lengths are supplied in bundles.

Types of wire Spools

Spool No.	Wire diameter mm	Nominal wire weight kg	D mm	d1 mm	d2 mm	L mm	l mm	Tare g
K 500	0.80 - 1.40	90	500	315	36	250	189	8000
K 355	0.40 - 1.40	50	355	224	36	200	160	1850
K 250	0.25 - 1.00	20	250	160	36	200	160	1050
K 200	0.25 - 0.80	14	200	125	22	200	160	600
K 160	0.20 - 0.80	7	160	100	22	160	128	350
K 125	0.15 - 0.80	3	125	80	16	125	100	200
K 100	0.127 - 0.25	1.5	100	63	16	100	80	125
K 80	0.127 - 0.25	0.5	80	50	16	80	64	70

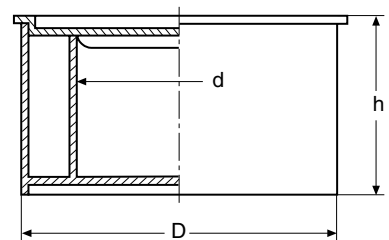

Fig. 3 - Drum dimensions

Types of Drums

Drum No.	Wire diameter mm	Nominal wire weight kg	D mm	d mm	h mm	Tare g
050 A	0.50 - 2.30	55	508	330	250	3500
020 B	0.50 - 1.63	36	508	330	150	2600

Types of Ribbon Spools

Spool No.	Tare g	Spool measurements, mm					Capacity, kg	
		D	d	l	d1	L	KANTHAL	NIKROTHAL
K 80	70	80	50	64	16	80	0.7	0.8
K 100	125	100	63	80	16	100	1.5	1.9
K 125	200	125	80	100	16	125	3	3.5
K 200	600	200	125	160	36	200	10	11

Rods

Available shaved or not shaved depending on the alloy.

In order to avoid transport damage all goods are carefully packed in cardboard boxes or wooden cases, with suitable internal protection.

9. Tables

The tables show metric values for wire and ribbon. There are other editions of this handbook for Imperial values (SWG and B&S).

For dimensions in the range 0.12-0.010 mm 0.0047-0.0004 in, we recommend the Kanthal Precision Technology Handbook. The larger dimensions and different elements are described more in detail in the Kanthal Handbook Resistance Heating Alloys and Systems for Industrial Furnaces.

For each table is indicated whether there

are standard stock items or not. Standard stock items may be changed without notice. Please ask Kanthal for the latest updated stock list. Standard stock items are normally supplied directly on order, while non-standard dimensions may take a bit longer.

Kanthal can supply any dimension on request, provided the volume is large enough.

KANTHAL A-1, APM Wire

Standard stock items	Alloy	Diameter range mm	Resistivity $\Omega\text{mm}^2\text{m}^{-1}$	Density gcm^{-3}
■	KANTHAL A-1	10.0-0.050	1.45	7.10
■	KANTHAL APM	10.0-0.20	1.45	7.10

To obtain resistance at working temperature, multiply by the factor C_t in the following table:

°C	20	100	200	300	400	500	600	700	800	900	1000	1100	1200	1300	1400
C_t	1.00	1.00	1.00	1.00	1.00	1.01	1.02	1.02	1.03	1.03	1.04	1.04	1.04	1.04	1.05

Diameter mm	APM	at 20 °C Ω/m	Resistance $\text{cm}^2/\Omega^{(1)}$ at 20 °C	Weight g/m	Surface area cm^2/m	Cross sectional area mm^2
10.0	10.0	0.0185	17017	558	314	78.5
9.5	9.5	0.0205	14590	503	298	70.9
	9.27	0.0215	13555	479	291	67.5
8.25	8.25	0.0271	9555	380	259	53.5
8.0	8.0	0.0288	8713	357	251	50.3
7.35	7.35	0.0342	6757	301	231	42.4
7.0	7.0	0.0377	5837	273	220	38.5
6.54		0.0432	4760	239	205	33.6
6.5	6.5	0.0437	4673	236	204	33.2
6.0	6.0	0.0513	3676	201	188	28.3
5.83		0.0543	3372	190	183	26.7
5.5	5.5	0.0610	2831	169	173	23.8
5.0	5.0	0.0738	2127	139	157	19.6
4.75	4.75	0.0818	1824	126	149	17.7
4.62		0.0865	1678	119	145	16.8
4.5	4.5	0.0912	1551	113	141	15.9
4.25	4.25	0.102	1306	101	134	14.2
4.11		0.109	1181	94.2	129	13.3
4.06		0.112	1139	91.9	128	12.9
4.0	4.0	0.115	1089	89.2	126	12.6
3.75	3.75	0.131	897	78.4	118	11.0
3.65		0.139	827	74.3	115	10.5
3.5	3.5	0.151	730	68.3	110	9.62
3.35		0.165	640	62.6	105	8.81
3.25	3.25	0.175	584	58.9	102	8.30
3.2		0.180	558	57.1	101	8.04

Diameter mm	A-1	APM	at 20 °C Ω/m	Resistance $\text{cm}^2/\Omega^{(1)}$ at 20 °C	Weight g/m	Surface area cm^2/m	Cross sectional area mm^2
3.0	3.0		0.205	459	50.2	94.2	7.07
2.95			0.212	437	48.5	92.7	6.83
2.9	2.9		0.220	415	46.9	91.1	6.61
2.8	2.8		0.235	374	43.7	88.0	6.16
2.65			0.263	317	39.2	83.3	5.52
2.6	2.6		0.273	299	37.7	81.7	5.31
2.5	2.5		0.295	266	34.9	78.5	4.91
2.4			0.321	235	32.1	75.4	4.52
2.34			0.337	218	30.5	73.5	4.30
2.3	2.3		0.349	207	29.5	72.3	4.15
2.25			0.365	194	28.2	70.7	3.98
2.2	2.2		0.381	181	27.0	69.1	3.80
2.05			0.439	147	23.4	64.4	3.30
2.03			0.448	142	23.0	63.8	3.24
2.0	2.0		0.462	136	22.3	62.8	3.14
1.83			0.551	104	18.7	57.5	2.63
1.8	1.8		0.570	99	18.1	56.5	2.54
1.7	1.7		0.639	83.6	16.1	53.4	2.27
1.6			0.695	73.7	14.8	51.2	2.09
1.6			0.721	69.7	14.3	50.3	2.01
1.5	1.5		0.821	57.4	12.5	47.1	1.77
1.4			0.942	46.7	10.9	44.0	1.54
1.3			1.09	37.4	9.42	40.8	1.33
1.2	1.2		1.28	29.4	8.03	37.7	1.13
1.1			1.53	22.6	6.75	34.6	0.950
1.0	1.0		1.85	17.0	5.58	31.4	0.785

¹⁾ $\text{cm}^2/\Omega = I^2 \cdot C_t/p$ (I = Current, C_t = temperature factor, p = surface load W/cm^2)

KANTHAL A, AF, AE Wire

Standard stock items	Alloy	Diameter range mm	Resistivity $\Omega\text{mm}^2\text{m}^{-1}$	Density gcm^{-3}
■	KANTHAL A	10.0-0.05	1.39	7.15
■	KANTHAL AF	10.0-0.10	1.39	7.15
—	KANTHAL AE	10.0-0.20	1.39	7.15

To obtain resistance at working temperature, multiply by the factor C_t in the following table:

°C	20	100	200	300	400	500	600	700	800	900	1000	1100	1200	1300
C_t	1.00	1.00	1.01	1.01	1.02	1.03	1.04	1.04	1.05	1.05	1.06	1.06	1.06	1.06

Diameter mm	A	AF	at 20 °C Ω/m	Resistance $\text{cm}^2/\Omega^{(1)}$ at 20 °C	Weight g/m	Surface area cm^2/m	Cross sectional area mm^2
10	10.0	0.0177	17751	562	314	78.	
	8.25	0.0260	9968	382	259	53.5	
	8.0	0.0277	9089	359	251	50.3	
	7.5	0.0315	7489	316	236	44.2	
	7.35	0.0328	7048	303	231	42.4	
	7.0	0.0361	6089	275	220	38.5	
	6.54	0.0414	4965	240	205	33.6	
	6.5	0.0419	4875	237	204	33.2	
	6.0	0.0492	3834	202	188	28.3	
	5.83	0.0521	3517	191	183	26.7	
	5.5	0.0585	2953	170	173	23.8	
	5.2	0.0655	2496	152	163	21.2	
	5.0	0.0708	2219	140	157	19.6	
	4.75	0.0784	1902	127	149	17.7	
	4.62	0.0829	1750	120	145	16.8	
	4.5	0.0874	1618	114	141	15.9	
	4.25	0.0980	1363	101	134	14.2	
	4.11	0.105	1232	94.9	129	13.3	
	4.0	0.111	1136	89.8	126	12.6	
	3.75	0.126	936	79.0	118	11.0	
	3.65	0.133	863	74.8	115	10.5	
	3.5	0.144	761	68.8	110	9.62	
	3.25	0.168	609	59.3	102	8.30	
	3.2	0.173	582	57.5	101	8.04	
	3.0	0.197	479	50.5	94.2	7.07	
	2.9	0.210	433	47.2	91.1	6.61	
	2.8	0.226	390	44.0	88.0	6.16	
	2.6	0.262	312	38.0	81.7	5.31	
	2.5	0.283	277	35.1	78.5	4.91	
	2.4	0.307	245	32.3	75.4	4.52	
	2.3	0.335	216	29.7	72.3	4.15	

Diameter mm	A	AF	at 20 °C Ω/m	Resistance $\text{cm}^2/\Omega^{(1)}$ at 20 °C	Weight g/m	Surface area cm^2/m	Cross sectional area mm^2
		2.25	0.350	202	28.4	70.7	3.98
		2.2	0.366	189	27.2	69.1	3.80
		2.0	0.442	142	22.5	62.8	3.14
		1.8	0.546	104	18.2	56.5	2.54
		1.7	0.612	87.2	16.2	53.4	2.27
		1.65	0.650	79.7	15.3	51.8	2.14
		1.6	0.691	72.7	14.4	50.3	2.01
		1.5	0.787	59.9	12.6	47.1	1.77
		1.4	0.903	48.7	11.0	44.0	1.54
		1.3	1.05	39.0	9.49	40.8	1.33
		1.2	1.23	30.7	8.09	37.7	1.13
		1.1	1.46	23.6	6.79	34.6	0.950
		1.0	1.77	17.8	5.62	31.4	0.785
		0.95	1.96	15.2	5.07	29.8	0.709
	0.90	0.90	2.18	12.9	4.55	28.3	0.636
	0.85	0.85	2.45	10.9	4.06	26.7	0.567
	0.80	0.80	2.77	9.09	3.59	25.1	0.503
	0.75	0.75	3.15	7.49	3.16	23.6	0.442
	0.70	0.70	3.61	6.09	2.75	22.0	0.385
	0.65	0.65	4.19	4.87	2.37	20.4	0.332
	0.60	0.60	4.92	3.83	2.02	18.8	0.283
	0.55	0.55	5.85	2.95	1.70	17.3	0.238
	0.50	0.50	7.08	2.22	1.40	15.7	0.196
	0.45	0.45	8.74	1.62	1.14	14.1	0.159
	0.40	0.40	11.1	1.14	0.898	12.6	0.126
	0.35	0.35	14.4	0.761	0.688	11.0	0.0962
	0.30	0.30	19.7	0.479	0.505	9.42	0.0707
	0.25		28.3	0.277	0.351	7.85	0.0491
	0.20		44.2	0.142	0.225	6.28	0.0314
	0.15		78.7	0.0599	0.126	4.71	0.0177

¹⁾ $\text{cm}^2/\Omega = I^2 \cdot C_t/p$ (I = Current, C_t = temperature factor, p = surface load W/cm^2)

KANTHAL A, AF, AE Ribbon

Alloy	Resistivity $\Omega\text{mm}^2\text{m}^{-1}$	Density gcm^{-3}
KANTHAL A, AF, AE	1.39	7.15

To obtain resistance at working temperature, multiply by the factor C_t in the following table:

°C	20	100	200	300	400	500	600	700	800	900	1000	1100	1200	1300
C_t	1.00	1.00	1.01	1.01	1.02	1.03	1.04	1.04	1.05	1.05	1.06	1.06	1.06	1.06

Width mm	Thick- ness mm	Resis- tance at 20 °C Ω/m	Resis- tance at 20 °C $\text{cm}^2/\Omega^{\text{①}}$	Weight g/m	Surface area cm^2/m	Cross sectional area mm^2
4	1.0	0.378	265	26.3	100	3.68
	0.90	0.420	234	23.7	98.0	3.31
	0.80	0.472	203	21.0	96.0	2.94
	0.70	0.540	174	18.4	94.0	2.58
	0.60	0.630	146	15.8	92.0	2.21
	0.50	0.755	119	13.2	90.0	1.84
	0.40	0.944	93.2	10.5	88.0	1.47
	0.30	1.26	68.3	7.89	86.0	1.10
	0.20	1.89	44.5	5.26	84.0	0.736
	0.15	2.52	33.0	3.95	83.0	0.552
	0.10	3.78	21.7	2.63	82.0	0.368
3	1.0	0.504	159	19.7	80.0	2.76
	0.90	0.560	139	17.8	78.0	2.48
	0.80	0.630	121	15.8	76.0	2.21
	0.70	0.719	103	13.8	74.0	1.93
	0.60	0.839	85.8	11.8	72.0	1.66
	0.50	1.01	69.5	9.87	70.0	1.38
	0.40	1.26	54.0	7.89	68.0	1.10
	0.30	1.68	39.3	5.92	66.0	0.828
	0.20	2.52	25.4	3.95	64.0	0.552
	0.15	3.36	18.8	2.96	63.0	0.414
	0.10	5.04	12.3	1.97	62.0	0.276
2.5	1.0	0.604	116	16.4	70.0	2.30
	0.90	0.671	101	14.8	68.0	2.07
	0.80	0.755	87.4	13.2	66.0	1.84
	0.70	0.863	74.1	11.5	64.0	1.61
	0.60	1.01	61.6	9.87	62.0	1.38
	0.50	1.21	49.6	8.22	60.0	1.15
	0.40	1.51	38.4	6.58	58.0	0.920
	0.30	2.01	27.8	4.93	56.0	0.690
	0.20	3.02	17.9	3.29	54.0	0.460
	0.15	4.03	13.2	2.47	53.0	0.345
	0.10	6.04	8.60	1.64	52.0	0.230
2.0	1.0	0.755	79.4	13.2	60.0	1.84
	0.90	0.839	69.1	11.8	58.0	1.66
	0.80	0.944	59.3	10.5	56.0	1.47
	0.70	1.08	50.0	9.21	54.0	1.29
	0.60	1.26	41.3	7.89	52.0	1.10
	0.50	1.51	33.1	6.58	50.0	0.920
	0.40	1.89	25.4	5.26	48.0	0.736
	0.30	2.52	18.3	3.95	46.0	0.552
	0.20	3.78	11.6	2.63	44.0	0.368
	0.15	5.04	8.54	1.97	43.0	0.276

Width mm	Thick- ness mm	Resis- tance at 20 °C Ω/m	Resis- tance at 20 °C $\text{cm}^2/\Omega^{\text{①}}$	Weight g/m	Surface area cm^2/m	Cross sectional area mm^2
2.0	0.10	7.55	5.56	1.32	42.0	0.184
	1.8	1.0	0.839	66.7	11.8	56.0
1.8	0.90	0.933	57.9	10.7	54.0	1.49
	0.80	1.05	49.6	9.47	52.0	1.32
	0.70	1.20	41.7	8.29	50.0	1.16
	0.60	1.40	34.3	7.10	48.0	0.994
	0.50	1.68	27.4	5.92	46.0	0.828
	0.40	2.10	21.0	4.74	44.0	0.662
	0.30	2.80	15.0	3.55	42.0	0.497
	0.20	4.20	9.53	2.37	40.0	0.331
	0.15	5.60	6.97	1.78	39.0	0.248
	0.10	8.39	4.53	1.18	38.0	0.166
	1.5	1.0	1.01	49.6	9.87	50.0
0.90		1.12	42.9	8.88	48.0	1.24
0.80		1.26	36.5	7.89	46.0	1.10
0.70		1.44	30.6	6.91	44.0	0.966
0.60		1.68	25.0	5.92	42.0	0.828
0.50		2.01	19.9	4.93	40.0	0.690
0.40		2.52	15.1	3.95	38.0	0.552
0.30		3.36	10.7	2.96	36.0	0.414
0.20		5.04	6.75	1.97	34.0	0.276
0.15		6.71	4.91	1.48	33.0	0.207
0.10		10.1	3.18	0.987	32.0	0.138
1.2	0.090	11.2	2.84	0.888	31.8	0.124
	0.080	12.6	2.51	0.789	31.6	0.110
	0.80	1.57	25.4	6.31	40.0	0.883
	0.70	1.80	21.1	5.53	38.0	0.773
	0.60	2.10	17.2	4.74	36.0	0.662
	0.50	2.52	13.5	3.95	34.0	0.552
	0.40	3.15	10.2	3.16	32.0	0.442
	0.30	4.20	7.15	2.37	30.0	0.331
	0.20	6.30	4.45	1.58	28.0	0.221
	0.15	8.39	3.22	1.18	27.0	0.166
	0.10	12.6	2.07	0.789	26.0	0.110
1.0	0.090	14.0	1.84	0.710	25.8	0.0994
	0.080	15.7	1.63	0.631	25.6	0.0883
	0.070	18.0	1.41	0.553	25.4	0.0773
	0.80	1.89	19.1	5.26	36.0	0.736
	0.70	2.16	15.8	4.60	34.0	0.644
	0.60	2.52	12.7	3.95	32.0	0.552
	0.50	3.02	9.93	3.29	30.0	0.460
	0.40	3.78	7.41	2.63	28.0	0.368
	0.30	5.04	5.16	1.97	26.0	0.276

^① $\text{cm}^2/\Omega = I^2 \cdot C_t/p$ (I = Current, C_t = temperature factor, p = surface load W/cm^2)

(cont.)

KANTHAL A, AF, AE Ribbon

Alloy	Resistivity $\Omega\text{mm}^2\text{m}^{-1}$	Density gcm^{-3}
KANTHAL A, AF, AE	1.39	7.15

To obtain resistance at working temperature, multiply by the factor C_t in the following table:

$^{\circ}\text{C}$	20	100	200	300	400	500	600	700	800	900	1000	1100	1200	1300
C_t	1.00	1.00	1.01	1.01	1.02	1.03	1.04	1.04	1.05	1.05	1.06	1.06	1.06	1.06

Width mm	Thick- ness mm	Resis- tance at 20 $^{\circ}\text{C}$ Ω/m	$\text{cm}^2/\Omega^1)$ at 20 $^{\circ}\text{C}$	Weight g/m	Surface area cm^2/m	Cross sectional area mm^2
1.0	0.20	7.55	3.18	1.32	24.0	0.184
	0.15	10.1	2.28	0.987	23.0	0.138
	0.10	15.1	1.46	0.658	22.0	0.0920
	0.090	16.8	1.30	0.592	21.8	0.0828
	0.080	18.9	1.14	0.526	21.6	0.0736
	0.070	21.6	0.991	0.460	21.4	0.0644
	0.060	25.2	0.842	0.395	21.2	0.0552
0.9	0.050	30.2	0.695	0.329	21.0	0.0460
	0.70	2.40	13.3	4.14	32.0	0.580
	0.60	2.80	10.7	3.55	30.0	0.497
	0.50	3.36	8.34	2.96	28.0	0.414
	0.40	4.20	6.20	2.37	26.0	0.331
	0.30	5.60	4.29	1.78	24.0	0.248
	0.20	8.39	2.62	1.18	22.0	0.166
0.8	0.15	11.2	1.88	0.888	21.0	0.124
	0.10	16.8	1.19	0.592	20.0	0.0828
	0.090	18.7	1.06	0.533	19.8	0.0745
	0.080	21.0	0.934	0.474	19.6	0.0662
	0.070	24.0	0.809	0.414	19.4	0.0580
	0.060	28.0	0.686	0.355	19.2	0.0497
	0.050	33.6	0.566	0.296	19.0	0.0414
	0.70	2.70	11.1	3.68	30.0	0.515
	0.60	3.15	8.90	3.16	28.0	0.442
	0.50	3.78	6.88	2.63	26.0	0.368
0.7	0.40	4.72	5.08	2.10	24.0	0.294
	0.30	6.30	3.49	1.58	22.0	0.221
	0.20	9.44	2.12	1.05	20.0	0.147
	0.15	12.6	1.51	0.789	19.0	0.110
	0.10	18.9	0.953	0.526	18.0	0.0736
	0.090	21.0	0.848	0.474	17.8	0.0662
	0.080	23.6	0.746	0.421	17.6	0.0589
	0.070	27.0	0.645	0.368	17.4	0.0515
	0.060	31.5	0.546	0.316	17.2	0.0442
	0.050	37.8	0.450	0.263	17.0	0.0368
0.6	0.60	3.60	7.23	2.76	26.0	0.386
	0.50	4.32	5.56	2.30	24.0	0.322
	0.40	5.40	4.08	1.84	22.0	0.258
	0.30	7.19	2.78	1.38	20.0	0.193
	0.20	10.8	1.67	0.921	18.0	0.129
	0.15	14.4	1.18	0.691	17.0	0.097
	0.10	21.6	0.741	0.460	16.0	0.0644
	0.090	24.0	0.659	0.414	15.8	0.0580
	0.080	27.0	0.578	0.368	15.6	0.0515

Width mm	Thick- ness mm	Resis- tance at 20 $^{\circ}\text{C}$ Ω/m	$\text{cm}^2/\Omega^1)$ at 20 $^{\circ}\text{C}$	Weight g/m	Surface area cm^2/m	Cross sectional area mm^2
0.7	0.070	30.8	0.499	0.322	15.4	0.0451
	0.060	36.0	0.423	0.276	15.2	0.0386
0.6	0.050	43.2	0.347	0.230	15.0	0.0322
	0.50	5.0	4.37	1.97	22.0	0.276
	0.40	6.3	3.18	1.58	20.0	0.221
	0.30	8.4	2.14	1.18	18.0	0.166
	0.20	12.6	1.27	0.789	16.0	0.110
	0.15	16.8	0.894	0.592	15.0	0.0828
	0.10	25.2	0.556	0.395	14.0	0.0552
0.5	0.090	28.0	0.493	0.355	13.8	0.0497
	0.080	31.5	0.432	0.316	13.6	0.0442
	0.070	36.0	0.373	0.276	13.4	0.0386
	0.060	42.0	0.315	0.237	13.2	0.0331
	0.050	50.4	0.258	0.197	13.0	0.0276
	0.040	63.0	0.203	0.158	12.8	0.0221
	0.30	10.1	1.59	0.987	16.0	0.138
	0.20	15.1	0.927	0.658	14.0	0.0920
	0.15	20.1	0.645	0.493	13.0	0.0690
	0.10	30.2	0.397	0.329	12.0	0.0460
0.4	0.090	33.6	0.351	0.296	11.8	0.0414
	0.080	37.8	0.307	0.263	11.6	0.0368
	0.070	43.2	0.264	0.230	11.4	0.0322
	0.060	50.4	0.222	0.197	11.2	0.0276
	0.050	60.4	0.182	0.164	11.0	0.0230
	0.040	75.5	0.143	0.132	10.8	0.0184
	0.30	12.6	1.11	0.789	14.0	0.110
	0.20	18.9	0.635	0.526	12.0	0.0736
	0.15	25.2	0.437	0.395	11.0	0.0552
	0.10	37.8	0.265	0.263	10.0	0.0368
0.3	0.090	42.0	0.234	0.237	9.80	0.0331
	0.080	47.2	0.203	0.210	9.60	0.0294
	0.070	54.0	0.174	0.184	9.40	0.0258
	0.060	63.0	0.146	0.158	9.20	0.0221
	0.050	75.5	0.119	0.132	9.00	0.0184
	0.20	25.2	0.397	0.395	10.0	0.0552
	0.15	33.6	0.268	0.296	9.00	0.0414
	0.10	50.4	0.159	0.197	8.00	0.0276
	0.090	56.0	0.139	0.178	7.80	0.0248
	0.080	63.0	0.121	0.158	7.60	0.0221
0.2	0.070	71.9	0.103	0.138	7.40	0.0193
	0.060	83.9	0.0858	0.118	7.20	0.0166
	0.050	101	0.0695	0.0987	7.00	0.0138

¹⁾ $\text{cm}^2/\Omega = I^2 \cdot C_t / p$ (I = Current, C_t = temperature factor, p = surface load W/cm^2)

KANTHAL D Wire

Standard stock items	Alloy	Diameter range mm	Resistivity $\Omega\text{mm}^2\text{m}^{-1}$	Density gcm^{-3}
■	D	8.0-0.020	1.35	7.25

To obtain resistance at working temperature, multiply by the factor C_t in the following table:

°C	20	100	200	300	400	500	600	700	800	900	1000	1100	1200	1300
C_t	1.00	1.00	1.01	1.01	1.02	1.03	1.04	1.05	1.06	1.07	1.07	1.07	1.08	1.08

Dia- meter mm	Resistance at 20 °C Ω/m	$\text{cm}^2/\Omega^{(1)}$ at 20 °C	Weight g/m	Surface area cm^2/m	Cross sectional area mm^2
8.0	0.0269	9358	364	251	50.3
6.5	0.0407	5019	241	204	33.2
6.0	0.0477	3948	205	188	28.3
5.5	0.0568	3041	172	173	23.8
5.0	0.0688	2285	142	157	19.6
4.75	0.0762	1959	128	149	17.7
4.5	0.0849	1666	115	141	15.9
4.25	0.0952	1403	103	134	14.2
4.06	0.104	1223	93.9	128	12.9
4.0	0.107	1170	91.1	126	12.6
3.75	0.122	964	80.1	118	11.0
3.65	0.129	889	75.9	115	10.5
3.5	0.140	784	69.8	110	9.62
3.25	0.163	627	60.1	102	8.30
3.0	0.191	493	51.2	94.2	7.07
2.95	0.198	469	49.6	92.7	6.8
2.8	0.219	401	44.6	88.0	6.16
2.65	0.245	340	40.0	83.3	5.5
2.5	0.275	286	35.6	78.5	4.91
2.0	0.430	146	22.8	62.8	3.14
1.8	0.531	107	18.4	56.5	2.54
1.7	0.595	89.8	16.5	53.4	2.27
1.6	0.671	74.9	14.6	50.3	2.01
1.5	0.764	61.7	12.8	47.1	1.77
1.4	0.877	50.2	11.2	44.0	1.54
1.3	1.02	40.2	9.62	40.8	1.33
1.2	1.19	31.6	8.20	37.7	1.13
1.1	1.42	24.3	6.89	34.6	0.950

Dia- meter mm	Resistance at 20 °C Ω/m	$\text{cm}^2/\Omega^{(1)}$ at 20 °C	Weight g/m	Surface area cm^2/m	Cross sectional area mm^2
1.0	1.72	18.3	5.69	31.4	0.785
0.95	1.90	15.7	5.14	29.8	0.709
0.90	2.12	13.3	4.61	28.3	0.636
0.85	2.38	11.2	4.11	26.7	0.567
0.80	2.69	9.36	3.64	25.1	0.503
0.75	3.06	7.71	3.20	23.6	0.442
0.70	3.51	6.27	2.79	22.0	0.385
0.65	4.07	5.02	2.41	20.4	0.332
0.60	4.77	3.95	2.05	18.8	0.283
0.55	5.68	3.04	1.72	17.3	0.238
0.50	6.88	2.28	1.42	15.7	0.196
0.45	8.49	1.67	1.15	14.1	0.159
0.42	9.74	1.35	1.00	13.2	0.139
0.40	10.7	1.17	0.911	12.6	0.126
0.35	14.0	0.784	0.698	11.0	0.0962
0.32	16.8	0.599	0.583	10.1	0.0804
0.30	19.1	0.493	0.512	9.42	0.0707
0.28	21.9	0.401	0.446	8.80	0.061
0.25	27.5	0.286	0.356	7.85	0.0491
0.22	35.5	0.195	0.276	6.91	0.0380
0.20	43.0	0.146	0.228	6.28	0.0314
0.19	47.6	0.125	0.206	5.97	0.0284
0.18	53.1	0.107	0.184	5.65	0.0254
0.17	59.5	0.0898	0.165	5.34	0.0227
0.16	67.1	0.0749	0.146	5.03	0.0201
0.15	76.4	0.0617	0.128	4.71	0.0177
0.14	87.7	0.0502	0.112	4.40	0.0154
0.13	102	0.0402	0.0962	4.08	0.0133

¹⁾ $\text{cm}^2/\Omega = I^2 \cdot C_t/p$ (I = Current, C_t = temperature factor, p = surface load W/cm^2)

KANTHAL D, DT

Ribbon

Alloy	Resistivity $\Omega\text{mm}^2\text{m}^{-1}$	Density gcm^{-3}
KANTHAL D	1.39	7.25
KANTHAL DT	1.37	7.25

To obtain resistance at working temperature, multiply by the factor C_t in the following table:

$^{\circ}\text{C}$	20	100	200	300	400	500	600	700	800	900	1000	1100	1200	1300
C_t	1.00	1.00	1.01	1.01	1.02	1.03	1.04	1.05	1.06	1.07	1.07	1.07	1.08	1.08

Width mm	Thickness mm	Resistance at 20 $^{\circ}\text{C}$ Ω/m	Resistance at 20 $^{\circ}\text{C}$ cm^2/Ω^1	Weight g/m	Surface area cm^2/m	Cross sectional area mm^2
4	1.0	0.367	273	26.7	100	3.68
	0.90	0.408	240	24.0	98.0	3.31
	0.80	0.459	209	21.3	96.0	2.94
	0.70	0.524	179	18.7	94.0	2.58
	0.60	0.611	150	16.0	92.0	2.21
	0.50	0.734	123	13.3	90.0	1.84
	0.40	0.917	96.0	10.7	88.0	1.47
	0.30	1.22	70.3	8.00	86.0	1.10
	0.20	1.83	45.8	5.34	84.0	0.736
	0.15	2.45	33.9	4.00	83.0	0.552
	0.10	3.67	22.4	2.67	82.0	0.368
	3	1.0	0.489	164	20.0	80.0
0.90		0.543	144	18.0	78.0	2.48
0.80		0.611	124	16.0	76.0	2.21
0.70		0.699	106	14.0	74.0	1.93
0.60		0.815	88.3	12.0	72.0	1.66
0.50		0.978	71.6	10.0	70.0	1.38
0.40		1.22	55.6	8.0	68.0	1.10
0.30		1.63	40.5	6.0	66.0	0.828
0.20		2.45	26.2	4.0	64.0	0.552
0.15		3.26	19.3	3.0	63.0	0.414
0.10		4.89	12.7	2.0	62.0	0.276
2.5		1.0	0.587	119	16.7	70.0
	0.90	0.652	104	15.0	68.0	2.07
	0.80	0.734	90.0	13.3	66.0	1.84
	0.70	0.839	76.3	11.7	64.0	1.61
	0.60	0.978	63.4	10.0	62.0	1.38
	0.50	1.17	51.1	8.34	60.0	1.15
	0.40	1.47	39.5	6.67	58.0	0.920
	0.30	1.96	28.6	5.00	56.0	0.690
	0.20	2.93	18.4	3.34	54.0	0.460
	0.15	3.91	13.5	2.50	53.0	0.345
	0.10	5.87	8.86	1.67	52.0	0.230
	2.25	1.0	0.652	99.7	15.0	65.0
0.90		0.725	86.9	13.5	63.0	1.86
0.80		0.815	74.8	12.0	61.0	1.66
0.70		0.932	63.3	10.5	59.0	1.45
0.60		1.09	52.4	9.00	57.0	1.24
0.50		1.30	42.2	7.50	55.0	1.04
0.40		1.63	32.5	6.00	53.0	0.828
0.30		2.17	23.5	4.50	51.0	0.621
0.20		3.26	15.0	3.00	49.0	0.414

Width mm	Thickness mm	Resistance at 20 $^{\circ}\text{C}$ Ω/m	Resistance at 20 $^{\circ}\text{C}$ cm^2/Ω^1	Weight g/m	Surface area cm^2/m	Cross sectional area mm^2	
2.25	0.15	4.35	11.0	2.25	48.0	0.311	
	0.10	6.52	7.21	1.50	47.0	0.207	
	2.0	1.0	0.734	81.8	13.3	60.0	1.84
2.0	0.90	0.815	71.1	12.0	58.0	1.66	
	0.80	0.917	61.1	10.7	56.0	1.47	
	0.70	1.05	51.5	9.34	54.0	1.29	
	0.60	1.22	42.5	8.00	52.0	1.10	
	0.50	1.47	34.1	6.67	50.0	0.920	
	0.40	1.83	26.2	5.34	48.0	0.736	
	0.30	2.45	18.8	4.00	46.0	0.552	
	0.20	3.67	12.0	2.67	44.0	0.368	
	0.15	4.89	8.79	2.00	43.0	0.276	
	0.10	7.34	5.72	1.33	42.0	0.184	
	1.75	1.0	0.839	65.6	11.7	55.0	1.61
		0.90	0.932	56.9	10.5	53.0	1.45
0.80		1.05	48.7	9.34	51.0	1.29	
0.70		1.20	40.9	8.17	49.0	1.13	
0.60		1.40	33.6	7.00	47.0	0.966	
0.50		1.68	26.8	5.84	45.0	0.805	
0.40		2.10	20.5	4.67	43.0	0.644	
0.30		2.80	14.7	3.50	41.0	0.483	
0.20		4.19	9.30	2.33	39.0	0.322	
0.15		5.59	6.80	1.75	38.0	0.242	
0.10		8.39	4.41	1.17	37.0	0.161	
1.5		0.70	1.40	31.5	7.00	44.0	0.966
	0.60	1.63	25.8	6.00	42.0	0.828	
	0.50	1.96	20.4	5.00	40.0	0.690	
	0.40	2.45	15.5	4.00	38.0	0.552	
	0.30	3.26	11.0	3.00	36.0	0.414	
	0.20	4.89	6.95	2.00	34.0	0.276	
	0.15	6.52	5.06	1.50	33.0	0.207	
	0.10	9.78	3.27	1.00	32.0	0.138	
	0.090	10.9	2.93	0.900	31.8	0.124	
	0.080	12.2	2.58	0.800	31.6	0.110	
	1.25	0.60	1.96	18.9	5.00	37.0	0.690
		0.50	2.35	14.9	4.17	35.0	0.575
0.40		2.93	11.2	3.34	33.0	0.460	
0.30		3.91	7.92	2.50	31.0	0.345	
0.20		5.87	4.94	1.67	29.0	0.230	
0.15		7.83	3.58	1.25	28.0	0.173	
0.10		11.7	2.30	0.834	27.0	0.115	
0.090		13.0	2.05	0.750	26.8	0.104	

¹⁾ $\text{cm}^2/\Omega = I^2 \cdot C_t / p$ (I = Current, C_t = temperature factor, p = surface load W/cm^2)

(cont.)

KANTHAL D, DT Ribbon

Alloy	Resistivity $\Omega\text{mm}^2\text{m}^{-1}$	Density gcm^{-3}
KANTHAL D	1.39	7.25
KANTHAL DT	1.37	7.25

To obtain resistance at working temperature, multiply by the factor C_i in the following table:

$^{\circ}\text{C}$	20	100	200	300	400	500	600	700	800	900	1000	1100	1200	1300
C_i	1.00	1.00	1.01	1.01	1.02	1.03	1.04	1.05	1.06	1.07	1.07	1.07	1.08	1.08

Width mm	Thick- ness mm	Resis- tance at 20 $^{\circ}\text{C}$ Ω/m	$\text{cm}^2/\Omega^1)$ at 20 $^{\circ}\text{C}$	Weight g/m	Surface area cm^2/m	Cross sectional area mm^2	
1.25	0.080	14.7	1.81	0.667	26.6	0.0920	
	0.070	16.8	1.57	0.584	26.4	0.0805	
	1.0	0.60	2.45	13.1	4.00	32.0	0.552
		0.50	2.93	10.2	3.34	30.0	0.460
		0.40	3.67	7.63	2.67	28.0	0.368
		0.30	4.89	5.32	2.00	26.0	0.276
		0.20	7.34	3.27	1.33	24.0	0.184
		0.15	9.78	2.35	1.00	23.0	0.138
		0.10	14.7	1.50	0.667	22.0	0.0920
		0.090	16.3	1.34	0.600	21.8	0.0828
0.080		18.3	1.18	0.534	21.6	0.0736	
0.070	21.0	1.02	0.467	21.4	0.0644		
0.9	0.060	24.5	0.867	0.400	21.2	0.0552	
	0.050	29.3	0.716	0.334	21.0	0.0460	
	0.50	3.26	8.59	3.00	28.0	0.414	
	0.40	4.08	6.38	2.40	26.0	0.331	
	0.30	5.43	4.42	1.80	24.0	0.248	
	0.20	8.15	2.70	1.20	22.0	0.166	
	0.15	10.9	1.93	0.900	21.0	0.124	
	0.10	16.3	1.23	0.600	20.0	0.0828	
	0.090	18.1	1.09	0.540	19.8	0.0745	
	0.080	20.4	0.962	0.480	19.6	0.0662	
0.8	0.070	23.3	0.833	0.420	19.4	0.0580	
	0.060	27.2	0.707	0.360	19.2	0.0497	
	0.050	32.6	0.583	0.300	19.0	0.0414	
	0.50	3.67	7.09	2.67	26.0	0.368	
	0.40	4.59	5.23	2.13	24.0	0.294	
	0.30	6.11	3.60	1.60	22.0	0.221	
	0.20	9.17	2.18	1.07	20.0	0.147	
	0.15	12.2	1.55	0.800	19.0	0.110	
	0.10	18.3	0.981	0.534	18.0	0.0736	
	0.090	20.4	0.873	0.480	17.8	0.0662	
0.7	0.080	22.9	0.768	0.427	17.6	0.0589	
	0.070	26.2	0.664	0.374	17.4	0.0515	
	0.060	30.6	0.563	0.320	17.2	0.0442	
	0.050	36.7	0.463	0.267	17.0	0.0368	
	0.40	5.24	4.20	1.87	22.0	0.258	
	0.30	6.99	2.86	1.40	20.0	0.193	
	0.20	10.5	1.72	0.934	18.0	0.129	
	0.15	14.0	1.22	0.700	17.0	0.097	
	0.10	21.0	0.763	0.467	16.0	0.0644	
	0.090	23.3	0.678	0.420	15.8	0.0580	

Width mm	Thick- ness mm	Resis- tance at 20 $^{\circ}\text{C}$ Ω/m	$\text{cm}^2/\Omega^1)$ at 20 $^{\circ}\text{C}$	Weight g/m	Surface area cm^2/m	Cross sectional area mm^2
0.7	0.080	26.2	0.595	0.374	15.6	0.0515
	0.070	29.9	0.514	0.327	15.4	0.0451
	0.060	34.9	0.435	0.280	15.2	0.0386
0.6	0.050	41.9	0.358	0.233	15.0	0.0322
	0.40	6.11	3.27	1.60	20.0	0.221
	0.30	8.15	2.21	1.20	18.0	0.166
0.5	0.20	12.2	1.31	0.800	16.0	0.110
	0.15	16.3	0.920	0.600	15.0	0.0828
	0.10	24.5	0.572	0.400	14.0	0.0552
	0.090	27.2	0.508	0.360	13.8	0.0497
	0.080	30.6	0.445	0.320	13.6	0.0442
	0.070	34.9	0.384	0.280	13.4	0.0386
	0.060	40.8	0.324	0.240	13.2	0.0331
	0.050	48.9	0.266	0.200	13.0	0.0276
	0.040	61.1	0.209	0.160	12.8	0.0221
	0.30	9.78	1.64	1.00	16.0	0.138
0.4	0.20	14.7	0.954	0.667	14.0	0.0920
	0.15	19.6	0.664	0.500	13.0	0.0690
	0.10	29.3	0.409	0.334	12.0	0.0460
	0.090	32.6	0.362	0.300	11.8	0.0414
	0.080	36.7	0.316	0.267	11.6	0.0368
	0.070	41.9	0.272	0.233	11.4	0.0322
	0.060	48.9	0.229	0.200	11.2	0.0276
	0.050	58.7	0.187	0.167	11.0	0.0230
	0.040	73.4	0.147	0.133	10.8	0.0184
	0.30	12.2	1.14	0.800	14.0	0.110
0.3	0.20	18.3	0.654	0.534	12.0	0.0736
	0.15	24.5	0.450	0.400	11.0	0.0552
	0.10	36.7	0.273	0.267	10.0	0.0368
	0.090	40.8	0.240	0.240	9.80	0.0331
	0.080	45.9	0.209	0.213	9.60	0.0294
	0.070	52.4	0.179	0.187	9.40	0.0258
	0.060	61.1	0.150	0.160	9.20	0.0221
	0.050	73.4	0.123	0.133	9.00	0.0184
	0.20	24.5	0.409	0.400	10.0	0.0552
	0.15	32.6	0.276	0.300	9.00	0.0414
0.2	0.10	48.9	0.164	0.200	8.00	0.0276
	0.090	54.3	0.144	0.180	7.80	0.0248
	0.080	61.1	0.124	0.160	7.60	0.0221
	0.070	69.9	0.106	0.140	7.40	0.0193
	0.060	81.5	0.0883	0.120	7.20	0.0166
	0.050	97.8	0.0716	0.100	7.00	0.0138

¹⁾ $\text{cm}^2/\Omega = I^2 \cdot C_i / p$ (I = Current, C_i = temperature factor, p = surface load W/cm^2)

ALKROTHAL Wire

Alloy	Diameter range mm	Resistivity $\Omega\text{mm}^2\text{m}^{-1}$	Density gcm^{-3}
ALKROTHAL	6.5-0.10	1.25	7.28

To obtain resistance at working temperature, multiply by the factor C_t in the following table:

°C	20	100	200	300	400	500	600	700	800	900	1000	1100
C_t	1.00	1.00	1.02	1.03	1.04	1.05	1.08	1.09	1.10	1.11	1.11	1.12

Dia- meter mm	Resistance at 20 °C Ω/m	cm^2/Ω^2 at 20 °C	Weight g/m	Surface area cm^2/m	Cross sectional area mm^2
6.5	0.0377	5421	242	204	33.2
6.0	0.0442	4264	206	188	28.3
5.5	0.0526	3284	173	173	23.8
5.0	0.0637	2467	143	157	19.6
4.75	0.0705	2115	129	149	17.7
4.5	0.0786	1799	116	141	15.9
4.25	0.0881	1515	103	134	14.2
4.0	0.0995	1263	91.5	126	12.6
3.75	0.113	1041	80.4	118	11.0
3.5	0.130	846	70.0	110	9.62
3.25	0.151	678	60.4	102	8.30
3.0	0.177	533	51.5	94.2	7.07
2.8	0.203	433	44.8	88.0	6.16
2.6	0.235	347	38.7	81.7	5.31
2.5	0.255	308	35.7	78.5	4.91
2.2	0.329	210	27.7	69.1	3.80
2.0	0.398	158	22.9	62.8	3.14
1.9	0.441	135	20.6	59.7	2.84
1.8	0.491	115	18.5	56.5	2.54
1.7	0.551	97.0	16.5	53.4	2.27
1.6	0.622	80.9	14.6	50.3	2.01
1.5	0.707	66.6	12.9	47.1	1.77
1.4	0.812	54.2	11.2	44.0	1.54
1.3	0.942	43.4	9.66	40.8	1.33
1.2	1.11	34.1	8.23	37.7	1.13
1.1	1.32	26.3	6.92	34.6	0.95
1.0	1.59	19.7	5.72	31.4	0.785
0.95	1.76	16.9	5.16	29.8	0.709
0.90	1.96	14.4	4.63	28.3	0.636
0.85	2.20	12.1	4.13	26.7	0.567

Dia- meter mm	Resistance at 20 °C Ω/m	cm^2/Ω^2 at 20 °C	Weight g/m	Surface area cm^2/m	Cross sectional area mm^2
0.80	2.49	10.1	3.66	25.1	0.503
0.75	2.83	8.33	3.22	23.6	0.442
0.70	3.25	6.77	2.80	22.0	0.385
0.65	3.77	5.42	2.42	20.4	0.332
0.60	4.42	4.26	2.06	18.8	0.283
0.55	5.26	3.28	1.73	17.3	0.238
0.50	6.37	2.47	1.43	15.7	0.196
0.475	7.05	2.12	1.29	14.9	0.177
0.45	7.86	1.80	1.16	14.1	0.159
0.425	8.81	1.52	1.03	13.4	0.142
0.40	9.95	1.26	0.915	12.6	0.126
0.375	11.3	1.04	0.804	11.8	0.110
0.35	13.0	0.846	0.700	11.0	0.0962
0.32	15.5	0.647	0.585	10.1	0.0804
0.30	17.7	0.533	0.515	9.42	0.0707
0.28	20.3	0.433	0.448	8.80	0.0616
0.26	23.5	0.347	0.387	8.17	0.0531
0.25	25.5	0.308	0.357	7.85	0.0491
0.24	27.6	0.273	0.329	7.54	0.0452
0.23	30.1	0.240	0.302	7.23	0.0415
0.22	32.9	0.210	0.277	6.91	0.0380
0.21	36.1	0.183	0.252	6.60	0.0346
0.20	39.8	0.158	0.229	6.28	0.0314
0.19	44.1	0.135	0.206	5.97	0.0284
0.18	49.1	0.115	0.185	5.65	0.0254
0.17	55.1	0.0970	0.165	5.34	0.0227
0.16	62.2	0.0809	0.146	5.03	0.0201
0.15	70.7	0.0666	0.129	4.71	0.0177
0.14	81.2	0.0542	0.112	4.40	0.0154
0.13	94.2	0.0434	0.0966	4.08	0.0133

¹⁾ $\text{cm}^2/\Omega = I^2 \cdot C_t / p$ (I = Current, C_t = temperature factor, p = surface load W/cm^2)

ALKROTHAL

Ribbon

Alloy	Resistivity $\Omega\text{mm}^{-1}\text{m}^{-1}$	Density gcm^{-3}
ALKROTHAL	1.25	7.28

To obtain resistance at working temperature, multiply by the factor C_i in the following table:

$^{\circ}\text{C}$	20	100	200	300	400	500	600	700	800	900	1000	1100
C_i	1.00	1.00	1.02	1.03	1.04	1.05	1.08	1.09	1.10	1.11	1.11	1.12

Width mm	Thick- ness mm	Resis- tance at 20 °C Ω/m	$\text{cm}^2/\Omega^{\text{①}}$ at 20 °C	Weight g/m	Surface area cm^2/m	Cross sectional area mm^2
4	1.0	0.340	294	26.8	100	3.68
	0.90	0.377	260	24.1	98.0	3.31
	0.80	0.425	226	21.4	96.0	2.94
	0.70	0.485	194	18.8	94.0	2.58
	0.60	0.566	163	16.1	92.0	2.21
	0.50	0.679	132	13.4	90.0	1.84
	0.40	0.849	103.6	10.7	88.0	1.47
	0.30	1.13	76.0	8.04	86.0	1.10
	0.20	1.70	49.5	5.36	84.0	0.736
	0.15	2.26	36.7	4.02	83.0	0.552
0.10	3.40	24.1	2.67	82.0	0.368	
3	1.0	0.453	177	20.1	80.0	2.76
	0.90	0.503	155	18.1	78.0	2.48
	0.80	0.566	134	16.1	76.0	2.21
	0.70	0.647	114	14.1	74.0	1.93
	0.60	0.755	95.4	12.1	72.0	1.66
	0.50	0.906	77.3	10.0	70.0	1.38
	0.40	1.13	60.1	8.0	68.0	1.10
	0.30	1.51	43.7	6.0	66.0	0.828
	0.20	2.26	28.3	4.0	64.0	0.552
	0.15	3.02	20.9	3.0	63.0	0.414
0.10	4.53	13.7	2.0	62.0	0.276	
2.5	1.0	0.543	129	16.7	70.0	2.30
	0.90	0.604	113	15.1	68.0	2.07
	0.80	0.679	97.2	13.4	66.0	1.84
	0.70	0.776	82.4	11.7	64.0	1.61
	0.60	0.906	68.4	10.0	62.0	1.38
	0.50	1.09	55.2	8.37	60.0	1.15
	0.40	1.36	42.7	6.70	58.0	0.920
	0.30	1.81	30.9	5.02	56.0	0.690
	0.20	2.72	19.9	3.35	54.0	0.460
	0.15	3.62	14.6	2.51	53.0	0.345
0.10	5.43	9.57	1.67	52.0	0.230	
2.25	1.0	0.604	107.6	15.1	65.0	2.07
	0.90	0.671	93.9	13.6	63.0	1.86
	0.80	0.755	80.8	12.1	61.0	1.66
	0.70	0.863	68.4	10.5	59.0	1.45
	0.60	1.006	56.6	9.0	57.0	1.24
	0.50	1.208	45.5	7.5	55.0	1.04
	0.40	1.510	35.1	6.0	53.0	0.828
	0.30	2.013	25.3	4.5	51.0	0.621
	0.20	3.019	16.2	3.0	49.0	0.414

Width mm	Thick- ness mm	Resis- tance at 20 °C Ω/m	$\text{cm}^2/\Omega^{\text{①}}$ at 20 °C	Weight g/m	Surface area cm^2/m	Cross sectional area mm^2
2.25	0.15	4.026	11.9	2.3	48.0	0.311
	0.10	6.52	7.21	1.5	47.0	0.207
2.0	1.0	0.679	88.3	13.4	60.0	1.84
	0.90	0.755	76.8	12.1	58.0	1.66
	0.80	0.849	65.9	10.7	56.0	1.47
	0.70	0.970	55.6	9.4	54.0	1.29
	0.60	1.13	45.9	8.04	52.0	1.10
	0.50	1.36	36.8	6.70	50.0	0.920
	0.40	1.70	28.3	5.36	48.0	0.736
	0.30	2.26	20.3	4.02	46.0	0.552
1.75	0.20	3.40	13.0	2.68	44.0	0.368
	0.15	4.53	9.5	2.01	43.0	0.276
	0.10	7.34	5.72	1.34	42.0	0.184
1.5	1.0	0.776	70.8	11.7	55.0	1.61
	0.90	0.863	61.4	10.5	53.0	1.45
	0.80	0.970	52.6	9.4	51.0	1.29
	0.70	1.11	44.2	8.20	49.0	1.13
	0.60	1.29	36.3	7.03	47.0	0.966
	0.50	1.55	29.0	5.86	45.0	0.805
	0.40	1.94	22.2	4.69	43.0	0.644
	0.30	2.59	15.8	3.52	41.0	0.483
1.25	0.20	3.88	10.0	2.34	39.0	0.322
	0.15	5.18	7.34	1.76	38.0	0.242
	0.10	8.39	4.41	1.17	37.0	0.161
	0.70	1.29	34.0	7.04	44.0	0.966
	0.60	1.51	27.8	6.03	42.0	0.828
	0.50	1.81	22.1	5.03	40.0	0.690
	0.40	2.26	16.8	4.02	38.0	0.552
	0.30	3.02	11.9	3.02	36.0	0.414
1.0	0.20	4.53	7.51	2.01	34.0	0.276
	0.15	6.04	5.46	1.51	33.0	0.207
	0.10	9.06	3.53	1.01	32.0	0.138
	0.090	10.1	3.16	0.905	31.8	0.124
	0.080	11.3	2.79	0.805	31.6	0.110
	0.60	1.81	20.4	5.02	37.0	0.690
	0.50	2.17	16.1	4.19	35.0	0.575
	0.40	2.72	12.1	3.35	33.0	0.460
0.75	0.30	3.62	8.56	2.51	31.0	0.345
	0.20	5.43	5.34	1.67	29.0	0.230
	0.15	7.25	3.86	1.26	28.0	0.173
	0.10	10.9	2.48	0.837	27.0	0.115
	0.090	12.1	2.22	0.753	26.8	0.104

^① $\text{cm}^2/\Omega = I^2 \cdot C_i/p$ (I = Current, C_i = temperature factor, p = surface load W/cm^2)

(cont.)

ALKROTHAL Ribbon

Alloy	Resistivity $\Omega\text{mm}^2\text{m}^{-1}$	Density gcm^{-3}
ALKROTHAL	1.25	7.28

To obtain resistance at working temperature, multiply by the factor C_t in the following table:

$^{\circ}\text{C}$	20	100	200	300	400	500	600	700	800	900	1000	1100
C_t	1.00	1.00	1.02	1.03	1.04	1.05	1.08	1.09	1.10	1.11	1.11	1.12

Width mm	Thick- ness mm	Resis- tance at 20 $^{\circ}\text{C}$ Ω/m	$\text{cm}^2/\Omega^{(1)}$ at 20 $^{\circ}\text{C}$	Weight g/m	Surface area cm^2/m	Cross sectional area mm^2
1.25	0.080	13.6	1.96	0.670	26.6	0.0920
	0.070	15.5	1.70	0.586	26.4	0.0805
1.0	0.60	2.26	14.1	4.02	32.0	0.552
	0.50	2.72	11.0	3.35	30.0	0.460
	0.40	3.40	8.24	2.68	28.0	0.368
	0.30	4.53	5.74	2.01	26.0	0.276
	0.20	6.79	3.53	1.34	24.0	0.184
	0.15	9.06	2.54	1.00	23.0	0.138
	0.10	13.6	1.62	0.670	22.0	0.0920
	0.090	15.1	1.44	0.603	21.8	0.0828
	0.080	17.0	1.27	0.536	21.6	0.0736
	0.070	19.4	1.10	0.469	21.4	0.0644
0.9	0.060	22.6	0.936	0.402	21.2	0.0552
	0.050	29.3	0.716	0.335	21.0	0.0460
	0.50	3.02	9.27	3.01	28.0	0.414
	0.40	3.77	6.89	2.41	26.0	0.331
	0.30	5.03	4.77	1.81	24.0	0.248
	0.20	7.55	2.91	1.21	22.0	0.166
	0.15	10.1	2.09	0.904	21.0	0.124
	0.10	15.1	1.32	0.603	20.0	0.0828
	0.090	16.8	1.18	0.543	19.8	0.0745
	0.080	18.9	1.039	0.482	19.6	0.0662
0.8	0.070	21.6	0.900	0.422	19.4	0.0580
	0.060	25.2	0.763	0.362	19.2	0.0497
	0.050	30.2	0.629	0.301	19.0	0.0414
	0.50	3.40	7.65	2.68	26.0	0.368
	0.40	4.25	5.65	2.14	24.0	0.294
	0.30	5.66	3.89	1.61	22.0	0.221
	0.20	8.49	2.36	1.07	20.0	0.147
	0.15	11.3	1.68	0.804	19.0	0.110
	0.10	17.0	1.060	0.536	18.0	0.0736
	0.090	18.9	0.943	0.482	17.8	0.0662
0.7	0.080	21.2	0.829	0.429	17.6	0.0589
	0.070	24.3	0.717	0.375	17.4	0.0515
	0.060	28.3	0.608	0.321	17.2	0.0442
	0.050	34.0	0.500	0.268	17.0	0.0368
	0.40	4.85	4.53	1.88	22.0	0.258
	0.30	6.47	3.09	1.41	20.0	0.193
	0.20	9.7	1.85	0.938	18.0	0.129
	0.15	12.9	1.31	0.703	17.0	0.097
	0.10	19.4	0.824	0.469	16.0	0.0644
	0.090	21.6	0.733	0.422	15.8	0.0580

Width mm	Thick- ness mm	Resis- tance at 20 $^{\circ}\text{C}$ Ω/m	$\text{cm}^2/\Omega^{(1)}$ at 20 $^{\circ}\text{C}$	Weight g/m	Surface area cm^2/m	Cross sectional area mm^2
0.7	0.080	24.3	0.643	0.375	15.6	0.0515
	0.070	27.7	0.555	0.328	15.4	0.0451
0.6	0.060	32.3	0.470	0.281	15.2	0.0386
	0.050	38.8	0.386	0.234	15.0	0.0322
	0.40	5.66	3.53	1.61	20.0	0.221
	0.30	7.55	2.38	1.21	18.0	0.166
0.5	0.20	11.3	1.41	0.804	16.0	0.110
	0.15	15.1	0.994	0.603	15.0	0.0828
	0.10	22.6	0.618	0.402	14.0	0.0552
	0.090	25.2	0.548	0.362	13.8	0.0497
	0.080	28.3	0.480	0.321	13.6	0.0442
	0.070	32.3	0.414	0.281	13.4	0.0386
	0.060	37.7	0.350	0.241	13.2	0.0331
	0.050	45.3	0.287	0.201	13.0	0.0276
	0.040	56.6	0.226	0.161	12.8	0.0221
	0.30	9.06	1.77	1.00	16.0	0.138
0.4	0.20	13.6	1.030	0.670	14.0	0.0920
	0.15	18.1	0.718	0.502	13.0	0.0690
	0.10	27.2	0.442	0.335	12.0	0.0460
	0.090	30.2	0.391	0.301	11.8	0.0414
	0.080	34.0	0.342	0.268	11.6	0.0368
	0.070	38.8	0.294	0.234	11.4	0.0322
	0.060	45.3	0.247	0.201	11.2	0.0276
	0.050	54.3	0.202	0.167	11.0	0.0230
	0.040	67.9	0.159	0.134	10.8	0.0184
	0.30	11.3	1.24	0.804	14.0	0.110
0.3	0.20	17.0	0.707	0.536	12.0	0.0736
	0.15	22.6	0.486	0.402	11.0	0.0552
	0.10	34.0	0.294	0.268	10.0	0.0368
	0.090	37.7	0.260	0.241	9.80	0.0331
	0.080	42.5	0.226	0.214	9.60	0.0294
	0.070	48.5	0.194	0.188	9.40	0.0258
	0.060	56.6	0.163	0.161	9.20	0.0221
	0.050	73.4	0.123	0.134	9.00	0.0184
	0.20	22.6	0.442	0.402	10.0	0.0552
	0.15	30.2	0.298	0.301	9.00	0.0414
0.2	0.10	45.3	0.177	0.201	8.00	0.0276
	0.090	50.3	0.155	0.181	7.80	0.0248
	0.080	56.6	0.134	0.161	7.60	0.0221
	0.070	64.7	0.114	0.141	7.40	0.0193
	0.060	75.5	0.0954	0.121	7.20	0.0166
	0.050	90.6	0.0773	0.100	7.00	0.0138

¹⁾ $\text{cm}^2/\Omega = I^2 \cdot C_t/p$ (I = Current, C_t = temperature factor, p = surface load W/cm^2)

NIKROTHAL 80, 70

Wire

Standard stock items	Alloy	Diameter range mm	Resistivity $\Omega\text{mm}^2\text{m}^{-1}$	Density gcm^{-3}
■	NIKROTHAL 80	8.0-0.020	1.09	8.30
—	NIKROTHAL 70	10.0-0.50	1.18	8.10

To obtain resistance at working temperature, multiply by the factor C_i in the following table:

°C	20	100	200	300	400	500	600	700	800	900	1000	1100	1200
N 80 C_i	1.00	1.01	1.02	1.03	1.04	1.05	1.04	1.04	1.04	1.04	1.05	1.06	1.07
N 70 C_i	1.00	1.01	1.02	1.03	1.04	1.05	1.05	1.04	1.04	1.04	1.05	1.06	1.06

To get NIKROTHAL 70, multiply the figures in the table with:

Resistance at 20 °C Ω/m	cm^2/Ω at 20 °C	Weight g/m
1.083	0.924	0.976

Dia-meter mm	Resistance at 20 °C Ω/m	cm^2/Ω^1 at 20 °C	Weight g/m	Surface area cm^2/m	Cross sectional area mm^2
10	0.0139	22637	652	314	78.5
9.5	0.0154	19408	588	298	70.9
9.0	0.0171	16502	528	283	63.6
8.25	0.0204	12711	444	259	53.5
8.0	0.0217	11590	417	251	50.3
7.5	0.0247	9550	367	236	44.2
7.0	0.0283	7764	319	220	38.5
6.5	0.0328	6217	275	204	33.2
6.0	0.0386	4890	235	188	28.3
5.83	0.0408	4486	222	183	26.7
5.5	0.0459	3766	197	173	23.8
5.0	0.0555	2830	163	157	19.6
4.75	0.0615	2426	147	149	17.7
4.5	0.0685	2063	132	141	15.9
4.25	0.0768	1738	118	134	14.2
4.0	0.0867	1449	104	126	12.6
3.75	0.0987	1194	91.7	118	11.0
3.65	0.104	1101	86.8	115	10.5
3.5	0.113	971	79.9	110	9.62
3.25	0.131	777	68.9	102	8.30
3.0	0.154	611	58.7	94.2	7.07
2.8	0.177	497	51.1	88.0	6.16
2.6	0.205	398	44.1	81.7	5.31
2.5	0.222	354	40.7	78.5	4.91
2.3	0.262	275	34.5	72.3	4.15
2.0	0.347	181	26.1	62.8	3.14
1.8	0.428	132	21.1	56.5	2.54
1.6	0.542	92.7	16.7	50.3	2.01
1.5	0.617	76.4	14.7	47.1	1.77
1.4	0.708	62.1	12.8	44.0	1.54

Dia-meter mm	Resistance at 20 °C Ω/m	cm^2/Ω^1 at 20 °C	Weight g/m	Surface area cm^2/m	Cross sectional area mm^2
1.3	0.821	49.7	11.0	40.8	1.33
1.2	0.964	39.1	9.39	37.7	1.13
1.0	1.39	22.6	6.52	31.4	0.785
0.95	1.54	19.4	5.88	29.8	0.709
0.90	1.71	16.5	5.28	28.3	0.636
0.85	1.92	13.9	4.71	26.7	0.567
0.80	2.17	11.6	4.17	25.1	0.503
0.75	2.47	9.55	3.67	23.6	0.442
0.70	2.83	7.76	3.19	22.0	0.385
0.65	3.28	6.22	2.75	20.4	0.332
0.60	3.86	4.89	2.35	18.8	0.283
0.55	4.59	3.77	1.97	17.3	0.238
0.50	5.55	2.83	1.63	15.7	0.196
0.45	6.85	2.06	1.32	14.1	0.159
0.40	8.67	1.45	1.04	12.6	0.126
0.35	11.3	0.971	0.799	11.0	0.0962
0.32	13.6	0.742	0.668	10.1	0.0804
0.30	15.4	0.611	0.587	9.42	0.0707
0.28	17.7	0.497	0.511	8.80	0.0616
0.25	22.2	0.354	0.407	7.85	0.0491
0.22	28.7	0.241	0.316	6.91	0.0380
0.20	34.7	0.181	0.261	6.28	0.0314
0.19	38.4	0.155	0.235	5.97	0.0284
0.18	42.8	0.132	0.211	5.65	0.0254
0.17	48.0	0.111	0.188	5.34	0.0227
0.16	54.2	0.0927	0.167	5.03	0.0201
0.15	61.7	0.0764	0.147	4.71	0.0177
0.14	70.8	0.0621	0.128	4.40	0.0154
0.13	82.1	0.0497	0.110	4.08	0.0133

¹⁾ $\text{cm}^2/\Omega = I^2 \cdot C_i/p$ (I = Current, C_i = temperature factor, p = surface load W/cm^2)

NIKROTHAL 60

Wire

Alloy	Diameter range mm	Resistivity $\Omega\text{mm}^2\text{m}^{-1}$	Density gcm^{-3}
NIKROTHAL 60	6.0-0.015	1.11	8.20

To obtain resistance at working temperature, multiply by the factor C_t in the following table:

$^{\circ}\text{C}$	20	100	200	300	400	500	600	700	800	900	1000	1100	1200
C_t	1.00	1.02	1.04	1.05	1.06	1.08	1.09	1.09	1.10	1.10	1.11	1.12	1.13

Dia- meter mm	Resistance at 20 $^{\circ}\text{C}$ Ω/m	cm^2/Ω^1 at 20 $^{\circ}\text{C}$	Weight g/m	Surface area cm^2/m	Cross sectional area mm^2
6.0	0.0393	4801	232	188	28.3
5.5	0.0467	3698	195	173	23.8
5.0	0.0565	2779	161	157	19.6
4.75	0.0626	2382	145	149	17.7
4.5	0.0698	2026	130	141	15.9
4.25	0.0782	1706	116	134	14.2
4.0	0.0883	1423	103	126	12.6
3.75	0.101	1172	90.6	118	11.0
3.5	0.115	953	78.9	110	9.62
3.25	0.134	763	68.0	102	8.30
3.0	0.157	600	58.0	94.2	7.07
2.8	0.180	488	50.5	88.0	6.16
2.6	0.209	391	43.5	81.7	5.31
2.5	0.226	347	40.3	78.5	4.91
2.2	0.292	237	31.2	69.1	3.80
2.0	0.353	178	25.8	62.8	3.14
1.9	0.391	152	23.2	59.7	2.84
1.8	0.436	130	20.9	56.5	2.54
1.7	0.489	109	18.6	53.4	2.27
1.6	0.552	91.0	16.5	50.3	2.01
1.5	0.628	75.0	14.5	47.1	1.77
1.4	0.721	61.0	12.6	44.0	1.54
1.3	0.836	48.8	10.9	40.8	1.33
1.2	0.981	38.4	9.27	37.7	1.13
1.1	1.17	29.6	7.79	34.6	0.950
1.0	1.41	22.2	6.44	31.4	0.785
0.95	1.57	19.1	5.81	29.8	0.709
0.90	1.74	16.2	5.22	28.3	0.636
0.85	1.96	13.7	4.65	26.7	0.567
0.80	2.21	11.4	4.12	25.1	0.503

Dia- meter mm	Resistance at 20 $^{\circ}\text{C}$ Ω/m	cm^2/Ω^1 at 20 $^{\circ}\text{C}$	Weight g/m	Surface area cm^2/m	Cross sectional area mm^2
0.75	2.51	9.38	3.62	23.6	0.442
0.70	2.88	7.62	3.16	22.0	0.385
0.65	3.35	6.10	2.72	20.4	0.332
0.60	3.93	4.80	2.32	18.8	0.283
0.55	4.67	3.70	1.95	17.3	0.238
0.50	5.65	2.78	1.61	15.7	0.196
0.475	6.26	2.38	1.45	14.9	0.177
0.45	6.98	2.03	1.30	14.1	0.159
0.425	7.82	1.71	1.16	13.4	0.142
0.40	8.83	1.42	1.03	12.6	0.126
0.375	10.1	1.17	0.906	11.8	
0.35	11.5	0.953	0.789	11.0	
0.32	13.8	0.728	0.659	10.1	
0.30	15.7	0.600	0.580	9.42	
0.28	18.0	0.488	0.505	8.80	
0.26	20.9	0.391	0.435	8.17	
0.25	22.6	0.347	0.403	7.85	
0.24	24.5	0.307	0.371	7.54	
0.23	26.7	0.270	0.341	7.23	
0.22	29.2	0.237	0.312	6.91	
0.21	32.0	0.206	0.284	6.60	
0.20	35.3	0.178	0.258	6.28	
0.19	39.1	0.152	0.232	5.97	
0.18	43.6	0.130	0.209	5.65	
0.17	48.9	0.109	0.186	5.34	
0.16	55.2	0.0910	0.165	5.03	
0.15	62.8	0.0750	0.145	4.71	
0.14	72.1	0.0610	0.126	4.40	
0.13	83.6	0.0488	0.109	4.08	

¹⁾ $\text{cm}^2/\Omega = I^2 \cdot C_t / p$ (I = Current, C_t = temperature factor, p = surface load W/cm^2)

NIKROTHAL 40, 20

Wire

Alloy	Diameter range mm	Resistivity $\Omega\text{mm}^2\text{m}^{-1}$	Density gcm^{-3}
NIKROTHAL 40	6.0-0.10	1.04	7.90
NIKROTHAL 20	6.0-0.10	0.95	7.80

To obtain resistance at working temperature, multiply by the factor C_t in the following table:

$^{\circ}\text{C}$	20	100	200	300	400	500	600	700	800	900	1000	1100
N40 C_t	1.00	1.03	1.06	1.10	1.12	1.15	1.17	1.19	1.21	1.22	1.23	1.24
N20 C_t	1.00	1.04	1.10	1.14	1.17	1.21	1.12	1.16	1.28	1.30	1.32	1.34

To get NIKROTHAL 20, multiply the figures in the table with:

Resistance at 20 $^{\circ}\text{C}$ Ω/m	cm^2/Ω at 20 $^{\circ}\text{C}$	Weight g/m
0.913	1.095	0.987

Dia-meter mm	Resistance at 20 $^{\circ}\text{C}$ Ω/m	$\text{cm}^2/\Omega^{(1)}$ at 20 $^{\circ}\text{C}$	Weight g/m	Surface area cm^2/m	Cross sectional area mm^2
6.0	0.0368	5125	223	188	28.3
5.5	0.0438	3947	188	173	23.8
5.0	0.0530	2966	155	157	19.6
4.75	0.0587	2543	140	149	17.7
4.5	0.0654	2162	126	141	15.9
4.25	0.0733	1821	112	134	14.2
4.0	0.0828	1518	99.3	126	12.6
3.75	0.094	1251	87.3	118	11.0
3.5	0.108	1017	76.0	110	9.62
3.25	0.125	814	65.5	102	8.30
3.0	0.147	641	55.8	94.2	7.07
2.8	0.169	521	48.6	88.0	6.16
2.6	0.196	417	41.9	81.7	5.31
2.5	0.212	371	38.8	78.5	4.91
2.2	0.274	253	30.0	69.1	3.80
2.0	0.331	190	24.8	62.8	3.14
1.9	0.367	163	22.4	59.7	2.84
1.8	0.409	138	20.1	56.5	2.54
1.7	0.458	117	17.9	53.4	2.27
1.6	0.517	97.2	15.9	50.3	2.01
1.5	0.589	80.1	14.0	47.1	1.77
1.4	0.676	65.1	12.2	44.0	1.54
1.3	0.784	52.1	10.5	40.8	1.33
1.2	0.920	41.0	8.93	37.7	1.13
1.1	1.09	31.6	7.51	34.6	0.950
1.0	1.32	23.7	6.20	31.4	0.785
0.95	1.47	20.3	5.60	29.8	0.709
0.90	1.63	17.3	5.03	28.3	0.636
0.85	1.83	14.6	4.48	26.7	0.567
0.80	2.07	12.1	3.97	25.1	0.503

Dia-meter mm	Resistance at 20 $^{\circ}\text{C}$ Ω/m	$\text{cm}^2/\Omega^{(1)}$ at 20 $^{\circ}\text{C}$	Weight g/m	Surface area cm^2/m	Cross sectional area mm^2
0.75	2.35	10.01	3.49	23.6	0.442
0.70	2.70	8.14	3.04	22.0	0.385
0.65	3.13	6.52	2.62	20.4	0.332
0.60	3.68	5.12	2.23	18.8	0.283
0.55	4.38	3.95	1.88	17.3	0.238
0.50	5.30	2.97	1.55	15.7	0.196
0.475	5.87	2.54	1.40	14.9	0.177
0.45	6.54	2.16	1.26	14.1	0.159
0.425	7.33	1.82	1.12	13.4	0.142
0.40	8.28	1.52	0.993	12.6	0.126
0.375	9.4	1.25	0.873	11.8	0.110
0.35	10.8	1.017	0.760	11.0	0.0962
0.32	12.9	0.777	0.635	10.1	0.0804
0.30	14.7	0.641	0.558	9.42	0.0707
0.28	16.9	0.521	0.486	8.80	0.0616
0.26	19.6	0.417	0.419	8.17	0.0531
0.25	21.2	0.371	0.388	7.85	0.0491
0.24	23.0	0.328	0.357	7.54	0.0452
0.23	25.0	0.289	0.328	7.23	0.0415
0.22	27.4	0.253	0.300	6.91	0.0380
0.21	30.0	0.220	0.274	6.60	0.0346
0.20	33.1	0.190	0.248	6.28	0.0314
0.19	36.7	0.163	0.224	5.97	0.0284
0.18	40.9	0.138	0.201	5.65	0.0254
0.17	45.8	0.117	0.179	5.34	0.0227
0.16	51.7	0.0972	0.159	5.03	0.0201
0.15	58.9	0.0801	0.140	4.71	0.0177
0.14	67.6	0.0651	0.122	4.40	0.0154
0.13	78.4	0.0521	0.105	4.08	0.0133

¹⁾ $\text{cm}^2/\Omega = I^2 \cdot C_t/p$ (I = Current, C_t = temperature factor, p = surface load W/cm^2)

NIKROTHAL 80, 60, 40

Ribbon

Alloy	Resistivity $\Omega\text{mm}^2\text{m}^{-1}$	Density gcm^{-3}
NIKROTHAL 80	1.09	8.30
NIKROTHAL 60	1.11	8.20
NIKROTHAL 40	1.04	7.90

To obtain resistance at working temperature, multiply by the factor C_t in the following table:

$^{\circ}\text{C}$	20	100	200	300	400	500	600	700	800	900	1000	1100	1200
N80 C_t	1.00	1.01	1.02	1.03	1.04	1.05	1.04	1.04	1.04	1.04	1.05	1.06	1.07
N60 C_t	1.00	1.02	1.04	1.05	1.06	1.08	1.09	1.09	1.10	1.10	1.11	1.12	1.13
N40 C_t	1.00	1.03	1.06	1.10	1.12	1.15	1.17	1.19	1.21	1.22	1.23	1.24	

To get N60 or N40, multiply the figures in the table with:

	Resistance at 20 $^{\circ}\text{C}$ Ω/m	cm^2/Ω at 20 $^{\circ}\text{C}$	Weight g/m
N60	1.018	0.982	0.988
N40	0.954	1.048	0.952

Width mm	Thick- ness mm	Resis- tance at 20 $^{\circ}\text{C}$ Ω/m	$\text{cm}^2(\Omega^{-1})$ at 20 $^{\circ}\text{C}$	Weight g/m	Surface area cm^2/m	Cross sectional area mm^2
4	1.0	0.296	338	30.5	100	3.68
	0.90	0.329	298	27.5	98.0	3.31
	0.80	0.370	259	24.4	96.0	2.94
	0.70	0.423	222	21.4	94.0	2.58
	0.60	0.494	186	18.3	92.0	2.21
	0.50	0.592	152	15.3	90.0	1.84
	0.40	0.740	119	12.2	88.0	1.47
	0.30	0.987	87.1	9.16	86.0	1.10
	0.20	1.48	56.7	6.11	84.0	0.736
	0.15	1.97	42.0	4.58	83.0	0.552
3	1.0	0.395	203	22.9	80.0	2.76
	0.90	0.439	178	20.6	78.0	2.48
	0.80	0.494	154	18.3	76.0	2.21
	0.70	0.564	131	16.0	74.0	1.93
	0.60	0.658	109	13.7	72.0	1.66
	0.50	0.790	88.6	11.5	70.0	1.38
	0.40	0.987	68.9	9.16	68.0	1.10
	0.30	1.32	50.1	6.87	66.0	0.828
	0.20	1.97	32.4	4.58	64.0	0.552
	0.15	2.63	23.9	3.44	63.0	0.414
2.5	1.0	0.474	148	19.1	70.0	2.30
	0.90	0.527	129	17.2	68.0	2.07
	0.80	0.592	111	15.3	66.0	1.84
	0.70	0.677	94.5	13.4	64.0	1.61
	0.60	0.790	78.5	11.5	62.0	1.38
	0.50	0.948	63.3	9.55	60.0	1.15
	0.40	1.18	49.0	7.64	58.0	0.920
	0.30	1.58	35.4	5.73	56.0	0.690
	0.20	2.37	22.8	3.82	54.0	0.460
	0.15	3.16	16.8	2.86	53.0	0.345
2.0	1.0	0.592	101	15.3	60.0	1.84
	0.90	0.658	88.1	13.7	58.0	1.66
	0.80	0.740	75.6	12.2	56.0	1.47

Width mm	Thick- ness mm	Resis- tance at 20 $^{\circ}\text{C}$ Ω/m	$\text{cm}^2(\Omega^{-1})$ at 20 $^{\circ}\text{C}$	Weight g/m	Surface area cm^2/m	Cross sectional area mm^2	
2.0	0.70	0.846	63.8	10.7	54.0	1.29	
	0.60	0.987	52.7	9.16	52.0	1.10	
	0.50	1.18	42.2	7.64	50.0	0.920	
	0.40	1.48	32.4	6.11	48.0	0.736	
	0.30	1.97	23.3	4.58	46.0	0.552	
	0.20	2.96	14.9	3.05	44.0	0.368	
	0.15	3.95	10.9	2.29	43.0	0.276	
	0.10	5.92	7.09	1.53	42.0	0.184	
	1.8	1.0	0.658	85.1	13.7	56.0	1.66
		0.90	0.731	73.8	12.4	54.0	1.49
0.80		0.823	63.2	11.0	52.0	1.32	
0.70		0.940	53.2	9.62	50.0	1.16	
0.60		1.10	43.8	8.25	48.0	0.994	
0.50		1.32	34.9	6.87	46.0	0.828	
0.40		1.65	26.7	5.50	44.0	0.662	
0.30		2.19	19.1	4.12	42.0	0.497	
0.20		3.29	12.2	2.75	40.0	0.331	
0.15		4.39	8.89	2.06	39.0	0.248	
1.5	1.0	0.790	63.3	11.5	50.0	1.38	
	0.90	0.878	54.7	10.3	48.0	1.24	
	0.80	0.987	46.6	9.16	46.0	1.10	
	0.70	1.13	39.0	8.02	44.0	0.966	
	0.60	1.32	31.9	6.87	42.0	0.828	
	0.50	1.58	25.3	5.73	40.0	0.690	
	0.40	1.97	19.2	4.58	38.0	0.552	
	0.30	2.63	13.7	3.44	36.0	0.414	
	0.20	3.95	8.61	2.29	34.0	0.276	
	0.15	5.27	6.27	1.72	33.0	0.207	
1.2	1.0	0.790	63.3	11.5	50.0	1.38	
	0.90	0.878	54.7	10.3	48.0	1.24	
	0.80	0.987	46.6	9.16	46.0	1.10	
	0.70	1.13	39.0	8.02	44.0	0.966	
	0.60	1.32	31.9	6.87	42.0	0.828	
	0.50	1.58	25.3	5.73	40.0	0.690	
	0.40	1.97	19.2	4.58	38.0	0.552	
	0.30	2.63	13.7	3.44	36.0	0.414	
	0.20	3.95	8.61	2.29	34.0	0.276	
	0.15	5.27	6.27	1.72	33.0	0.207	

¹⁾ $\text{cm}^2/\Omega = I^2 \cdot C_t / p$ (I = Current, C_t = temperature factor, p = surface load W/cm^2)

(cont.)

NIKROTHAL 80, 60, 40

Ribbon

Alloy	Resistivity $\Omega\text{mm}^2\text{m}^{-1}$	Density gcm^{-3}
NIKROTHAL 80	1.09	8.30
NIKROTHAL 60	1.11	8.20
NIKROTHAL 40	1.04	7.90

Width mm	Thick- ness mm	Resis- tance at 20 °C		Weight g/m	Surface area cm^2/m	Cross sectional area mm^2	
		Ω/m	cm^2/Ω^1				
1.0	0.40	2.47	13.0	3.67	32.0	0.442	
	0.30	3.29	9.12	2.75	30.0	0.331	
	0.20	4.94	5.67	1.83	28.0	0.221	
	0.15	6.58	4.10	1.37	27.0	0.166	
	0.10	9.87	2.63	0.916	26.0	0.110	
	0.090	11.0	2.35	0.825	25.8	0.099	
	0.080	12.3	2.07	0.733	25.6	0.088	
	0.070	14.1	1.80	0.641	25.4	0.077	
	0.80	1.48	24.3	6.11	36.0	0.736	
	0.70	1.69	20.1	5.35	34.0	0.644	
0.9	0.60	1.97	16.2	4.58	32.0	0.552	
	0.50	2.37	12.7	3.82	30.0	0.460	
	0.40	2.96	9.45	3.05	28.0	0.368	
	0.30	3.95	6.58	2.29	26.0	0.276	
	0.20	5.92	4.05	1.53	24.0	0.184	
	0.15	7.90	2.91	1.15	23.0	0.138	
	0.10	11.8	1.86	0.764	22.0	0.0920	
	0.090	13.2	1.66	0.687	21.8	0.0828	
	0.080	14.8	1.46	0.611	21.6	0.0736	
	0.070	16.9	1.26	0.535	21.4	0.0644	
0.8	0.060	19.7	1.07	0.458	21.2	0.0552	
	0.050	23.7	0.886	0.382	21.0	0.0460	
	0.70	1.88	17.0	4.81	32.0	0.580	
	0.60	2.19	13.7	4.12	30.0	0.497	
	0.50	2.63	10.6	3.44	28.0	0.414	
	0.40	3.29	7.90	2.75	26.0	0.331	
	0.30	4.39	5.47	2.06	24.0	0.248	
	0.20	6.58	3.34	1.37	22.0	0.166	
	0.15	8.78	2.39	1.03	21.0	0.124	
	0.10	13.2	1.52	0.687	20.0	0.0828	
0.7	0.090	14.6	1.35	0.619	19.8	0.0745	
	0.080	16.5	1.19	0.550	19.6	0.0662	
	0.070	18.8	1.03	0.481	19.4	0.0580	
	0.060	21.9	0.875	0.412	19.2	0.0497	
	0.050	26.3	0.722	0.344	19.0	0.0414	
	0.70	2.12	14.2	4.28	30.0	0.515	
	0.60	2.47	11.3	3.67	28.0	0.442	
	0.50	2.96	8.78	3.05	26.0	0.368	
	0.40	3.70	6.48	2.44	24.0	0.294	
	0.30	4.94	4.46	1.83	22.0	0.221	
0.6	0.20	7.40	2.70	1.22	20.0	0.147	
	0.15	9.87	1.92	0.916	19.0	0.110	
	0.10	14.8	1.22	0.611	18.0	0.0736	
	0.090	16.5	1.08	0.550	17.8	0.0662	
	0.080	18.5	0.951	0.489	17.6	0.0589	
	0.070	21.2	0.822	0.428	17.4	0.0515	
	0.060	24.7	0.697	0.367	17.2	0.0442	
	0.050	29.6	0.574	0.305	17.0	0.0368	
	0.70	0.60	2.82	9.22	3.21	26.0	0.386
	0.50	3.39	7.09	2.67	24.0	0.322	
0.5	0.40	4.23	5.20	2.14	22.0	0.258	
	0.30	5.64	3.54	1.60	20.0	0.193	
	0.20	8.46	2.13	1.07	18.0	0.129	
	0.15	11.3	1.51	0.802	17.0	0.097	
	0.10	16.9	0.945	0.535	16.0	0.0644	
	0.090	18.8	0.840	0.481	15.8	0.0580	
	0.080	21.2	0.737	0.428	15.6	0.0515	
	0.070	24.2	0.637	0.374	15.4	0.0451	
	0.060	28.2	0.539	0.321	15.2	0.0386	
	0.050	33.9	0.443	0.267	15.0	0.0322	
0.4	0.60	3.95	5.57	2.29	22.0	0.276	
	0.40	4.94	4.05	1.83	20.0	0.221	
	0.30	6.58	2.73	1.37	18.0	0.166	
	0.20	9.87	1.62	0.916	16.0	0.110	
	0.15	13.2	1.14	0.687	15.0	0.0828	
	0.10	19.7	0.709	0.458	14.0	0.0552	
	0.090	21.9	0.629	0.412	13.8	0.0497	
	0.080	24.7	0.551	0.367	13.6	0.0442	
	0.070	28.2	0.475	0.321	13.4	0.0386	
	0.060	32.9	0.401	0.275	13.2	0.0331	
0.3	0.050	39.5	0.329	0.229	13.0	0.0276	
	0.040	49.4	0.259	0.183	12.8	0.0221	
	0.50	3.30	7.90	2.03	1.15	16.0	0.138
	0.20	11.8	1.18	0.764	14.0	0.0920	
	0.15	15.8	0.823	0.573	13.0	0.0690	
	0.10	23.7	0.506	0.382	12.0	0.0460	
	0.090	26.3	0.448	0.344	11.8	0.0414	
	0.080	29.6	0.392	0.305	11.6	0.0368	
	0.070	33.9	0.337	0.267	11.4	0.0322	
	0.060	39.5	0.284	0.229	11.2	0.0276	
0.2	0.050	47.4	0.232	0.191	11.0	0.0230	
	0.040	59.2	0.182	0.153	10.8	0.0184	
	0.40	3.30	9.87	1.42	0.916	14.0	0.110
	0.20	14.8	0.810	0.611	12.0	0.0736	
	0.15	19.7	0.557	0.458	11.0	0.0552	
	0.10	29.6	0.338	0.305	10.0	0.0368	
	0.090	32.9	0.298	0.275	9.80	0.0331	
	0.080	37.0	0.259	0.244	9.60	0.0294	
	0.070	42.3	0.222	0.214	9.40	0.0258	
	0.060	49.4	0.186	0.183	9.20	0.0221	
0.1	0.050	59.2	0.152	0.153	9.00	0.0184	
	0.20	19.7	0.506	0.458	10.0	0.0552	
	0.15	26.3	0.342	0.344	9.00	0.0414	
	0.10	39.5	0.203	0.229	8.00	0.0276	
	0.090	43.9	0.178	0.206	7.80	0.0248	
	0.080	49.4	0.154	0.183	7.60	0.0221	
	0.070	56.4	0.131	0.160	7.40	0.0193	
	0.060	65.8	0.109	0.137	7.20	0.0166	
	0.050	79.0	0.0886	0.115	7.00	0.0138	

¹⁾ $\text{cm}^2/\Omega = I^2 \cdot C_t / p$ (I = Current, C_t = temperature factor, p = surface load W/cm^2)

NIFETHAL 70 and 52 Wire

Alloy	Diameter range mm	Resistivity $\Omega\text{mm}^2\text{m}^{-1}$	Density gcm^{-3}
NIFETHAL 70	4.0-0.10	0.20	8.45
NIFETHAL 52	4.0-0.10	0.43	8.20

To obtain resistance at working temperature, multiply by the factor C_t in the following table:

°C	20	100	150	200	250	300	350	400	450	500
NIFETHAL 70 C_t	1.00	1.42	1.68	1.91	2.19	2.47	2.75	3.03	3.34	3.66
NIFETHAL 52 C_t	1.00	1.33	1.53	1.73	1.93	2.13	2.32	2.49	2.64	2.77

NIFETHAL 70					
Dia- meter mm	Resistance at 20 °C Ω/m	cm^2/Ω^2 at 20 °C	Weight g/m	Surface area cm^2/m	Cross sectional area mm^2
1.8	0.0786	719	21.5	56.5	2.54
1.7	0.0881	606	19.2	53.4	2.27
1.6	0.0995	505	17.0	50.3	2.01
1.5	0.113	416	14.9	47.1	1.77
1.4	0.130	339	13.0	44.0	1.54
1.3	0.151	271	11.2	40.8	1.33
1.2	0.177	213	9.56	37.7	1.13
1.1	0.210	164	8.03	34.6	0.950
1.0	0.255	123	6.64	31.4	0.785
0.95	0.282	106	5.99	29.8	0.709
0.90	0.314	89.9	5.38	28.3	0.636
0.85	0.352	75.8	4.79	26.7	0.567
0.80	0.398	63.2	4.25	25.1	0.503
0.75	0.453	52.0	3.73	23.6	0.442
0.70	0.520	42.3	3.25	22.0	0.385
0.65	0.603	33.9	2.80	20.4	0.332
0.60	0.707	26.6	2.39	18.8	0.283
0.55	0.842	20.5	2.01	17.3	0.238
0.50	1.02	15.4	1.66	15.7	0.196
0.475	1.13	13.2	1.50	14.9	0.177
0.45	1.26	11.2	1.34	14.1	0.159
0.425	1.41	9.47	1.20	13.4	0.142
0.40	1.59	7.90	1.06	12.6	0.126
0.375	1.81	6.51	0.933	11.8	0.110
0.35	2.08	5.29	0.813	11.0	0.0962
0.32	2.49	4.04	0.680	10.1	0.0804
0.30	2.83	3.33	0.597	9.42	0.0707
0.28	3.25	2.71	0.520	8.80	0.0616
0.26	3.77	2.17	0.449	8.17	0.0531
0.25	4.07	1.93	0.415	7.85	0.0491
0.24	4.42	1.71	0.382	7.54	0.0452
0.23	4.81	1.50	0.351	7.23	0.0415
0.22	5.26	1.31	0.321	6.91	0.0380
0.21	5.77	1.14	0.293	6.60	0.0346
0.20	6.37	0.987	0.265	6.28	0.0314
0.19	7.05	0.846	0.240	5.97	0.0284
0.18	7.86	0.719	0.215	5.65	0.0254
0.17	8.81	0.606	0.192	5.34	0.0227
0.16	9.95	0.505	0.170	5.03	0.0201
0.15	11.3	0.416	0.149	4.71	0.0177
0.14	13.0	0.339	0.130	4.40	0.0154
0.13	15.1	0.271	0.112	4.08	0.0133
0.12	17.7	0.213	0.0956	3.77	0.0113
0.11	21.0	0.164	0.0803	3.46	0.00950
0.10	25.5	0.123	0.0664	3.14	0.00785

NIFETHAL 52					
Dia- meter mm	Resistance at 20 °C Ω/m	cm^2/Ω^2 at 20 °C	Weight g/m	Surface area cm^2/m	Cross sectional area mm^2
1.8	0.169	335	20.9	56.5	2.54
1.7	0.189	282	18.6	53.4	2.27
1.6	0.214	235	16.5	50.3	2.01
1.5	0.243	194	14.5	47.1	1.77
1.4	0.279	157	12.6	44.0	1.54
1.3	0.324	126	10.9	40.8	1.33
1.2	0.380	99.2	9.27	37.7	1.13
1.1	0.452	76.4	7.79	34.6	0.950
1.0	0.547	57.4	6.44	31.4	0.785
0.95	0.607	49.2	5.81	29.8	0.709
0.90	0.676	41.8	5.22	28.3	0.636
0.85	0.758	35.2	4.65	26.7	0.567
0.80	0.855	29.4	4.12	25.1	0.503
0.75	0.973	24.2	3.62	23.6	0.442
0.70	1.12	19.7	3.16	22.0	0.385
0.65	1.30	15.8	2.72	20.4	0.332
0.60	1.52	12.4	2.32	18.8	0.283
0.55	1.81	9.55	1.95	17.3	0.238
0.50	2.19	7.17	1.61	15.7	0.196
0.475	2.43	6.15	1.45	14.9	0.177
0.45	2.70	5.23	1.30	14.1	0.159
0.425	3.03	4.40	1.16	13.4	0.142
0.40	3.42	3.67	1.030	12.6	0.126
0.375	3.89	3.03	0.906	11.8	0.110
0.35	4.47	2.46	0.789	11.0	0.0962
0.32	5.35	1.88	0.659	10.1	0.0804
0.30	6.08	1.55	0.580	9.42	0.0707
0.28	6.98	1.26	0.505	8.80	0.0616
0.26	8.10	1.01	0.435	8.17	0.0531
0.25	8.76	0.897	0.403	7.85	0.0491
0.24	9.51	0.793	0.371	7.54	0.0452
0.23	10.3	0.698	0.341	7.23	0.0415
0.22	11.3	0.611	0.312	6.91	0.0380
0.21	12.4	0.531	0.284	6.60	0.0346
0.20	13.7	0.459	0.258	6.28	0.0314
0.19	15.2	0.394	0.232	5.97	0.0284
0.18	16.9	0.335	0.209	5.65	0.0254
0.17	18.9	0.282	0.186	5.34	0.0227
0.16	21.4	0.235	0.165	5.03	0.0201
0.15	24.3	0.194	0.145	4.71	0.0177
0.14	27.9	0.157	0.126	4.40	0.0154
0.13	32.4	0.126	0.1088	4.08	0.0133
0.12	38.0	0.0992	0.0927	3.77	0.0113
0.11	45.2	0.0764	0.0779	3.46	0.00950
0.10	54.7	0.0574	0.0644	3.14	0.00785

¹⁾ $\text{cm}^2/\Omega = I^2 \cdot C_t/p$ (I = Current, C_t = temperature factor, p = surface load W/cm^2)

Copper-Nickel Wire

Alloy	Diameter range mm	Resistivity $\Omega\text{mm}^2\text{m}^{-1}$	Density gcm^{-3}
CUPROTHAL 49	4.0-0.10	0.49	8.90
MANGANINA 43	8.0-0.10	0.43	8.40
CUPROTHAL 30	4.0-0.10	0.30	8.90
CUPROTHAL 15	4.0-0.10	0.15	8.90
CUPROTHAL 10	4.0-0.10	0.10	8.90
CUPROTHAL 05	4.0-0.10	0.05	8.90

To obtain resistance at working temperature, multiply by the factor C_t in the following table:

Alloy	20 °C	100 °C	200 °C	300 °C	400 v	500 °C	600 °C
CUPROTHAL 49	1.000	1.002	1.002	1.001	1.005	1.017	1.037
MANGANINA 43*	-	-	-	-	-	-	-
CUPROTHAL 30	1.000	1.020	1.030	1.040	1.060	-	-
CUPROTHAL 15	1.000	1.035	1.070	1.110	1.150	-	-
CUPROTHAL 10	1.000	1.060	1.110	1.190	-	-	-
CUPROTHAL 05	1.000	1.110	1.250	1.400	-	-	-

* The use of this alloy is limited to the range 15-35 °C.

Multiply the figures in the table with:

Resistance at 20 °C Ω/m	cm^2/Ω at 20 °C	Weight g/m	
1.0	1.0	1.0	CUPROTHAL 49
0.877	1.15	0.94	MANGANINA 43
0.612	1.63	1.0	CUPROTHAL 30
0.306	3.29	1.0	CUPROTHAL 15
0.204	4.93	1.0	CUPROTHAL 10
0.102	9.86	1.0	CUPROTHAL 05

Dia-meter mm	Resistance at 20 °C Ω/m	$\text{cm}^2/\Omega^{(1)}$ at 20 °C	Weight g/m	Surface area cm^2/m	Cross sectional area mm^2
10	0.0062	50355	699	314	78.5
9.5	0.0069	43173	631	298	70.9
9.0	0.0077	36709	566	283	63.6
8.25	0.0092	28275	476	259	53.5
8.0	0.0097	25782	447	251	50.3
7.5	0.0111	21244	393	236	44.2
7.35	0.0115	19994	378	231	42.4
7.0	0.0127	17272	343	220	38.5
6.5	0.0148	13829	295	204	33.2
6.0	0.0173	10877	252	188	28.3
5.5	0.0206	8378	211	173	23.8
5.0	0.0250	6294	175	157	19.6
4.75	0.0277	5397	158	149	17.7
4.5	0.0308	4589	142	141	15.9
4.25	0.0345	3866	126	134	14.2
4.0	0.0390	3223	112	126	12.6
3.75	0.0444	2655	98.3	118	11.0
3.5	0.0509	2159	85.6	110	9.62
3.25	0.0591	1729	73.8	102	8.30
3.0	0.0693	1360	62.9	94.2	7.07
2.8	0.0796	1105	54.8	88.0	6.16
2.6	0.0923	885	47.3	81.7	5.31
2.5	0.100	787	43.7	78.5	4.91
2.2	0.129	536	33.8	69.1	3.80
2.0	0.156	403	28.0	62.8	3.14
1.9	0.173	345	25.2	59.7	2.84
1.8	0.193	294	22.6	56.5	2.54

Dia-meter mm	Resistance at 20 °C Ω/m	$\text{cm}^2/\Omega^{(1)}$ at 20 °C	Weight g/m	Surface area cm^2/m	Cross sectional area mm^2
1.7	0.216	247	20.2	53.4	2.27
1.6	0.244	206	17.9	50.3	2.01
1.5	0.277	170	15.7	47.1	1.77
1.4	0.318	138	13.7	44.0	1.54
1.3	0.369	111	11.8	40.8	1.33
1.2	0.433	87.0	10.1	37.7	1.13
1.1	0.516	67.0	8.46	34.6	0.950
1.0	0.624	50.4	6.99	31.4	0.785
0.95	0.691	43.2	6.31	29.8	0.709
0.90	0.770	36.7	5.66	28.3	0.636
0.85	0.864	30.9	5.05	26.7	0.567
0.80	0.975	25.8	4.47	25.1	0.503
0.75	1.11	21.2	3.93	23.6	0.442
0.70	1.27	17.3	3.43	22.0	0.385
0.65	1.48	13.8	2.95	20.4	0.332
0.60	1.73	10.9	2.52	18.8	0.283
0.55	2.06	8.38	2.11	17.3	0.238
0.50	2.50	6.29	1.75	15.7	0.196
0.475	2.77	5.40	1.58	14.9	0.177
0.45	3.08	4.59	1.42	14.1	0.159
0.425	3.45	3.87	1.26	13.4	0.142
0.40	3.90	3.22	1.12	12.6	0.126
0.375	4.44	2.66	0.983	11.8	
0.35	5.09	2.16	0.856	11.0	
0.32	6.09	1.65	0.716	10.1	
0.30	6.93	1.36	0.629	9.42	
0.28	7.96	1.11	0.548	8.80	

¹⁾ $\text{cm}^2/\Omega = I^2 \cdot C_t/p$ (I = Current, C_t = temperature factor, p = surface load W/cm^2)

(cont.)

(cont.)

Copper-Nickel Wire

Alloy	Diameter range mm	Resistivity $\Omega\text{mm}^2\text{m}^{-1}$	Density gcm^{-3}
CUPROTHAL 49	4.0-0.10	0.49	8.90
MANGANINA 43	8.0-0.10	0.43	8.40
CUPROTHAL 30	4.0-0.10	0.30	8.90
CUPROTHAL 15	4.0-0.10	0.15	8.90
CUPROTHAL 10	4.0-0.10	0.10	8.90
CUPROTHAL 05	4.0-0.10	0.05	8.90

To obtain resistance at working temperature, multiply by the factor C_t in the following table:

Alloy	20 °C	100 °C	200 °C	300 °C	400 v	500 °C	600 °C
CUPROTHAL 49	1.000	1.002	1.002	1.001	1.005	1.017	1.037
MANGANINA 43*	-	-	-	-	-	-	-
CUPROTHAL 30	1.000	1.020	1.030	1.040	1.060	-	-
CUPROTHAL 15	1.000	1.035	1.070	1.110	1.150	-	-
CUPROTHAL 10	1.000	1.060	1.110	1.190	-	-	-
CUPROTHAL 05	1.000	1.110	1.250	1.400	-	-	-

* The use of this alloy is limited to the range 15-35 °C.

Multiply the figures in the table with:

Resistance at 20 °C Ω/m	cm^2/Ω at 20 °C	Weight g/m	
1.0	1.0	1.0	CUPROTHAL 49
0.877	1.15	0.94	MANGANINA 43
0.612	1.63	1.0	CUPROTHAL 30
0.306	3.29	1.0	CUPROTHAL 15
0.204	4.93	1.0	CUPROTHAL 10
0.102	9.86	1.0	CUPROTHAL 05

Dia-meter mm	Resistance at 20 °C Ω/m	cm^2/Ω^1 at 20 °C	Weight g/m	Surface area cm^2/m	Cross sectional area mm^2
0.26	9.23	0.885	0.473	8.17	
0.25	10.0	0.787	0.437	7.85	
0.24	10.8	0.696	0.403	7.54	
0.23	11.8	0.613	0.370	7.23	
0.22	12.9	0.536	0.338	6.91	
0.21	14.1	0.466	0.308	6.60	
0.20	15.6	0.403	0.280	6.28	

Dia-meter mm	Resistance at 20 °C Ω/m	cm^2/Ω^1 at 20 °C	Weight g/m	Surface area cm^2/m	Cross sectional area mm^2
0.19	17.3	0.345	0.252	5.97	
0.18	19.3	0.294	0.226	5.65	
0.17	21.6	0.247	0.202	5.34	
0.16	24.4	0.2063	0.179	5.03	
0.15	27.7	0.1699	0.157	4.71	
0.14	31.8	0.1382	0.137	4.40	
0.13	36.9	0.1106	0.118	4.08	

¹⁾ $\text{cm}^2/\Omega = I^2 \cdot C_t / p$ (I = Current, C_t = temperature factor, p = surface load W/cm^2)

Copper-Nickel Ribbon

Alloy	Resistivity $\Omega\text{mm}^2\text{m}^{-1}$	Density gcm^{-3}
CUPROTHAL 49	0.49	8.90

To obtain resistance at working temperature, multiply by the factor C_t in the following table:

Alloy	20 °C	100 °C	200 °C	300 °C	400 °C	500 °C	600 °C
CUPROTHAL 49	1.000	1.002	1.002	1.001	1.005	1.017	1.037

Width mm	Thick- ness mm	Resis- tance at 20 °C Ω/m	cm^2/Ω^1 at 20 °C	Weight g/m	Surface area cm^2/m	Cross sectional area mm^2
4	1.0	0.133	751	32.8	100	3.68
	0.90	0.148	662	29.5	98.0	3.31
	0.80	0.166	577	26.2	96.0	2.94
	0.70	0.190	494	22.9	94.0	2.58
	0.60	0.222	415	19.7	92.0	2.21
	0.50	0.266	338	16.4	90.0	1.84
	0.40	0.333	264	13.1	88.0	1.47
	0.30	0.444	193.8	9.83	86.0	1.10
	0.20	0.666	126.2	6.55	84.0	0.736
	0.15	0.888	93.5	4.91	83.0	0.552
	0.10	1.33	61.6	3.28	82.0	0.368
3	1.0	0.178	451	24.6	80.0	2.76
	0.90	0.197	395	22.1	78.0	2.48
	0.80	0.222	342	19.7	76.0	2.21
	0.70	0.254	292	17.2	74.0	1.93
	0.60	0.296	243	14.7	72.0	1.66
	0.50	0.355	197	12.3	70.0	1.38
	0.40	0.444	153	9.83	68.0	1.10
	0.30	0.592	112	7.37	66.0	0.828
	0.20	0.888	72.1	4.91	64.0	0.552
	0.15	1.18	53.2	3.68	63.0	0.414
	0.10	1.78	34.9	2.46	62.0	0.276
2.5	1.0	0.213	329	20.5	70.0	2.30
	0.90	0.237	287	18.4	68.0	2.07
	0.80	0.266	248	16.4	66.0	1.84
	0.70	0.304	210	14.3	64.0	1.61
	0.60	0.355	175	12.3	62.0	1.38
	0.50	0.426	141	10.2	60.0	1.15
	0.40	0.533	109	8.19	58.0	0.920
	0.30	0.710	78.9	6.14	56.0	0.690
	0.20	1.07	50.7	4.09	54.0	0.460
	0.15	1.42	37.3	3.07	53.0	0.345
	0.10	2.13	24.4	2.05	52.0	0.230
2.0	1.0	0.266	225	16.4	60.0	1.84
	0.90	0.296	196.0	14.7	58.0	1.66
	0.80	0.333	168	13.1	56.0	1.47
	0.70	0.380	142	11.5	54.0	1.29
	0.60	0.444	117	9.83	52.0	1.10
	0.50	0.533	93.9	8.19	50.0	0.920
	0.40	0.666	72.1	6.55	48.0	0.736
	0.30	0.888	51.8	4.91	46.0	0.552
	0.20	1.33	33.0	3.28	44.0	0.368
	0.15	1.78	24.2	2.46	43.0	0.276
	0.10	2.66	15.77	1.64	42.0	0.184

Width mm	Thick- ness mm	Resis- tance at 20 °C Ω/m	cm^2/Ω^1 at 20 °C	Weight g/m	Surface area cm^2/m	Cross sectional area mm^2
1.8	1.0	0.296	189	14.7	56.0	1.66
	0.90	0.329	164	13.3	54.0	1.49
	0.80	0.370	141	11.8	52.0	1.32
	0.70	0.423	118	10.3	50.0	1.16
	0.60	0.493	97.3	8.84	48.0	0.994
	0.50	0.592	77.7	7.37	46.0	0.828
	0.40	0.740	59.5	5.90	44.0	0.662
	0.30	0.986	42.6	4.42	42.0	0.497
	0.20	1.48	27.0	2.95	40.0	0.331
	0.15	1.97	19.77	2.21	39.0	0.248
	0.10	2.96	12.84	1.47	38.0	0.166
1.5	1.0	0.355	141	12.3	50.0	1.38
	0.90	0.395	122	11.1	48.0	1.24
	0.80	0.444	104	9.83	46.0	1.10
	0.70	0.507	86.7	8.60	44.0	0.966
	0.60	0.592	71.0	7.37	42.0	0.828
	0.50	0.710	56.3	6.14	40.0	0.690
	0.40	0.888	42.8	4.91	38.0	0.552
	0.30	1.18	30.4	3.68	36.0	0.414
	0.20	1.78	19.2	2.46	34.0	0.276
	0.15	2.37	13.9	1.84	33.0	0.207
	0.10	3.55	9.01	1.23	32.0	0.138
1.2	0.090	3.95	8.06	1.11	31.8	0.124
	0.080	4.44	7.12	0.983	31.6	0.110
	0.80	0.555	72.1	7.86	40.0	0.883
	0.70	0.634	59.9	6.88	38.0	0.773
	0.60	0.740	48.7	5.90	36.0	0.662
	0.50	0.888	38.3	4.91	34.0	0.552
	0.40	1.11	28.8	3.93	32.0	0.442
	0.30	1.48	20.3	2.95	30.0	0.331
	0.20	2.22	12.6	1.97	28.0	0.221
	0.15	2.96	9.12	1.47	27.0	0.166
	0.10	4.44	5.86	0.983	26.0	0.110
1.0	0.090	4.93	5.23	0.884	25.8	0.099
	0.080	5.55	4.61	0.786	25.6	0.088
	0.070	6.34	4.01	0.688	25.4	0.077
	0.80	0.67	54.1	6.55	36.0	0.736
	0.70	0.76	44.7	5.73	34.0	0.644
	0.60	0.89	36.0	4.91	32.0	0.552
	0.50	1.1	28.2	4.09	30.0	0.460
	0.40	1.3	21.0	3.28	28.0	0.368
	0.30	1.8	14.6	2.46	26.0	0.276
	0.20	2.7	9.01	1.64	24.0	0.184
	0.15	3.6	6.48	1.23	23.0	0.138

¹⁾ $\text{cm}^2/\Omega = I^2 \cdot C_t / p$ (I = Current, C_t = temperature factor, p = surface load W/cm^2)

(cont.)

(cont.)

Copper-Nickel Ribbon

Alloy	Resistivity $\Omega\text{mm}^2\text{m}^{-1}$	Density gcm^{-3}
CUPROTHAL 49	0.49	8.90

To obtain resistance at working temperature, multiply by the factor C_t in the following table:

Alloy	20 °C	100 °C	200 °C	300 °C	400 °C	500 °C	600 °C
CUPROTHAL 49	1.000	1.002	1.002	1.001	1.005	1.017	1.037

Width mm	Thick- ness mm	Resis- tance at 20 °C Ω/m	$\text{cm}^2/\Omega^1)$ at 20 °C	Weight g/m	Surface area cm^2/m	Cross sectional area mm^2
1.0	0.10	5.3	4.13	0.819	22.0	0.0920
	0.090	5.9	3.68	0.737	21.8	0.0828
	0.080	6.7	3.24	0.655	21.6	0.0736
	0.070	7.6	2.81	0.573	21.4	0.0644
	0.060	8.9	2.39	0.491	21.2	0.0552
	0.050	10.7	1.97	0.409	21.0	0.0460
	0.9	0.70	0.85	37.9	5.16	32.0
0.60		0.99	30.4	4.42	30.0	0.497
0.50		1.2	23.7	3.68	28.0	0.414
0.40		1.5	17.6	2.95	26.0	0.331
0.30		2.0	12.2	2.21	24.0	0.248
0.20		3.0	7.44	1.47	22.0	0.166
0.15		3.9	5.32	1.11	21.0	0.124
0.10		5.9	3.38	0.737	20.0	0.0828
0.090		6.6	3.01	0.663	19.8	0.0745
0.080		7.4	2.65	0.590	19.6	0.0662
0.070		8.5	2.29	0.516	19.4	0.0580
0.060		9.9	1.95	0.442	19.2	0.0497
0.050		11.8	1.61	0.368	19.0	0.0414
0.8	0.70	0.951	31.5	4.59	30.0	0.515
	0.60	1.11	25.2	3.93	28.0	0.442
	0.50	1.33	19.53	3.28	26.0	0.368
	0.40	1.66	14.42	2.62	24.0	0.294
	0.30	2.22	9.91	1.97	22.0	0.221
	0.20	3.33	6.01	1.31	20.0	0.147
	0.15	4.44	4.28	0.983	19.0	0.110
	0.10	6.66	2.70	0.655	18.0	0.0736
	0.090	7.40	2.41	0.590	17.8	0.0662
	0.080	8.32	2.11	0.524	17.6	0.0589
	0.070	9.51	1.83	0.459	17.4	0.0515
	0.060	11.1	1.55	0.393	17.2	0.0442
	0.050	13.3	1.28	0.328	17.0	0.0368
0.7	0.60	1.27	20.50	3.44	26.0	0.386
	0.50	1.52	15.77	2.87	24.0	0.322
	0.40	1.90	11.57	2.29	22.0	0.258
	0.30	2.54	7.89	1.72	20.0	0.193
	0.20	3.80	4.73	1.15	18.0	0.129
	0.15	5.07	3.35	0.860	17.0	0.0966
	0.10	7.61	2.10	0.573	16.0	0.0644
	0.090	8.45	1.87	0.516	15.8	0.0580
	0.080	9.51	1.64	0.459	15.6	0.0515
	0.070	10.9	1.42	0.401	15.4	0.0451

Width mm	Thick- ness mm	Resis- tance at 20 °C Ω/m	$\text{cm}^2/\Omega^1)$ at 20 °C	Weight g/m	Surface area cm^2/m	Cross sectional area mm^2	
0.7	0.060	12.7	1.20	0.344	15.2	0.0386	
	0.050	15.2	0.986	0.287	15.0	0.0322	
	0.6	0.50	1.78	12.4	2.46	22.0	0.276
0.40		2.22	9.01	1.97	20.0	0.221	
0.30		2.96	6.08	1.47	18.0	0.166	
0.20		4.44	3.60	0.983	16.0	0.110	
0.15		5.92	2.53	0.737	15.0	0.0828	
0.10		8.88	1.58	0.491	14.0	0.0552	
0.090		9.86	1.40	0.442	13.8	0.0497	
0.5	0.080	11.1	1.23	0.393	13.6	0.0442	
	0.070	12.7	1.06	0.344	13.4	0.0386	
	0.060	14.8	0.892	0.295	13.2	0.0331	
	0.050	17.8	0.732	0.246	13.0	0.0276	
	0.040	22.2	0.577	0.197	12.8	0.0221	
	0.4	0.30	3.55	4.51	1.23	16.0	0.138
		0.20	5.33	2.63	0.819	14.0	0.0920
		0.15	7.10	1.83	0.614	13.0	0.0690
		0.10	10.7	1.13	0.409	12.0	0.0460
		0.090	11.8	0.997	0.368	11.8	0.0414
		0.080	13.3	0.871	0.328	11.6	0.0368
		0.070	15.2	0.749	0.287	11.4	0.0322
		0.060	17.8	0.631	0.246	11.2	0.0276
0.050		21.3	0.516	0.205	11.0	0.0230	
0.040		26.6	0.406	0.164	10.8	0.0184	
0.3		0.30	4.44	3.15	0.983	14.0	0.110
		0.20	6.66	1.80	0.655	12.0	0.0736
		0.15	8.88	1.24	0.491	11.0	0.0552
	0.10	13.3	0.751	0.328	10.0	0.0368	
	0.090	14.8	0.662	0.295	9.80	0.0331	
	0.080	16.6	0.577	0.262	9.60	0.0294	
	0.070	19.0	0.494	0.229	9.40	0.0258	
	0.060	22.2	0.415	0.197	9.20	0.0221	
	0.050	26.6	0.338	0.164	9.00	0.0184	
	0.3	0.20	8.88	1.13	0.491	10.0	0.0552
		0.15	11.8	0.760	0.368	9.00	0.0414
		0.10	17.8	0.451	0.246	8.00	0.0276
		0.090	19.7	0.395	0.221	7.80	0.0248
0.080		22.2	0.342	0.197	7.60	0.0221	
0.070		25.4	0.292	0.172	7.40	0.0193	
0.060		29.6	0.243	0.147	7.20	0.0166	
0.050	35.5	0.197	0.123	7.00	0.0138		

¹⁾ $\text{cm}^2/\Omega = I^2 \cdot C_t / p$ (I = Current, C_t = temperature factor, p = surface load W/cm^2)

10. Appendix

1. List of symbols

The symbols used comply as far as possible with internationally approved standards.

The following symbols are used:

Symbol	Meaning	Metric	Unit for Calculation Imperial
A_C	Surface area of heating conductor	cm^2	in^2
b	Width (ribbon or strip)	mm	in
C_t	Temperature factor (ratio of resistivity at operating temperature to resistivity at room temperature)		
d	Wire diameter	mm	in
D	Outer coil diameter	mm	in
I	Current	A	A
L	Length of heating conductor	m	ft
L_e	Coil length	mm	in
p	Surface load of heating element	W/cm^2	W/in^2
P	Power	W	W
q	Cross-sectional area of heating conductor	mm^2	in^2
R_T	Resistance at working temperature	Ω	Ω
R_{20}	Resistance at room temperature (20 °C, 68 °F)	Ω	Ω
s	Pitch	mm	in
t	Thickness (ribbon or strip)	mm	in
T, θ	Temperature	K, °C	K, °F
U	Voltage	V	V
α	Temperature coefficient of resistivity	K^{-1}	$^{\circ}\text{F}^{-1}$
γ	Density (old marking)	g/cm^3	lb/in^3
ρ	Resistivity	$\Omega \text{ mm}^2\text{m}^{-1}$	$\Omega/\text{smf}^*\Omega/\text{cmf}$
10	Balancing factor used in the formulas makes possible that the values can be used with units of section 1: e.g. wire diameter, d , in [mm] or [in] is different from length of heating conductor, L in [m] or [ft].		

* smf = square mil-foot
cmf = circular mil-foot

2. Formulas and Definitions

The following formulas and definitions are applied to all applications.

Definition :
Resistivity R [Ωmm²/m] or [Ω/cmf]

The resistance of a conductor, R₂₀, is directly proportional to its length, L and inversely proportional to its cross-sectional area, q:

$$R_{20} = \rho \frac{L}{q} \quad [1]$$

The proportional constant, ρ is defined as the resistivity of the material and is temperature dependent. The unit of ρ is in metric system [Ωmm²/m] respectively for imperial system [Ω/cmf].

Definition :
Temperature factor C_t [--]

Resistivity or change in resistance with temperature, is non-linear for most resistance heating alloys. Hence, the temperature factor, C_t, is often used instead of temperature coefficient. C_t is defined as the ratio between the resistivity or resistance at some selected temperature θ °C and the resistivity or resistance at 20 °C (68 °F).

$$R_T = C_t \cdot R_{20} \quad [\Omega] \quad [2]$$

$$C_t = \frac{R_T}{R_{20}} \quad [--] \quad [3]$$

$$C_t = 1 + (\theta - 20)\alpha \quad (\text{Where } \theta \text{ is in } ^\circ\text{C}) \quad [4]$$

$$C_t = 1 + (\theta - 68)\alpha \quad (\text{Where } \theta \text{ is in } ^\circ\text{F}) \quad [5]$$

Definition :
Surface load p [W/cm²] or [W/in²]

The surface load of a heating conductor, p, is its power, P, divided by its surface area, A_c.

$$p = \frac{P}{A_c} \quad [\text{W}/\text{cm}^2] \text{ or } [\text{W}/\text{in}^2] \quad [6]$$

metric / imperial
 Wire

$$A_C = \pi \cdot d \cdot L \cdot 10 \quad [7]$$

$$A_C = \pi \cdot d \cdot L \cdot 12$$

strip / ribbon

$$A_C = 2 \cdot (b + t) \cdot L \cdot 10 \quad [8]$$

$$A_C = 2 \cdot (b + t) \cdot L \cdot 12$$

General formulas

$$U = R_T \cdot I \quad [V] \quad [9]$$

$$P = U \cdot I \quad [W] \quad [10]$$

Combining equations [9] and [10] gives:

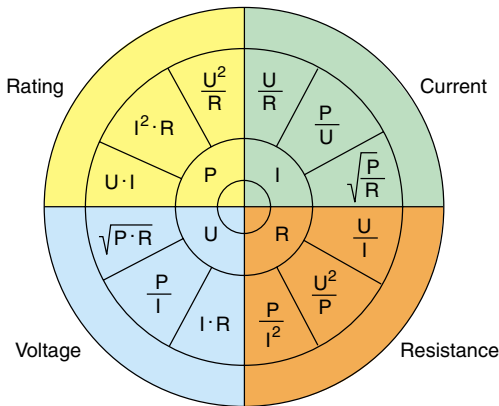

Combining equations [2], [6], [9] and [10] gives:

$$\frac{A_C}{R_{20}} = \frac{I^2 \cdot C_t}{p} \quad [cm^2/\Omega] \text{ or } [in^2/\Omega] \quad [11]$$

The ratio $\frac{A_C}{R_{20}}$, used for determining wire, strip or ribbon size, is tabulated for all alloys in the Kanthal Handbook.

Definition:

Cross sectional area q [mm²] or [in²]

A) Round wire

$$q = \frac{\pi}{4} \cdot d^2 \quad [mm^2] \text{ or } [in^2] \quad [12]$$

Combining equations [1], [6], [7] and [12] gives the wire diameter, d:

$$d = \sqrt[3]{\frac{4}{\pi^2} \cdot \frac{\rho \cdot P}{p \cdot R_{20}}} \quad [13]$$

metric

$$d = \sqrt[3]{\frac{4}{\pi^2} \cdot \frac{\rho \cdot P}{p \cdot R_{20}} \cdot \frac{L}{10}} \text{ [mm]} \quad [13]$$

imperial

$$d = \sqrt[3]{\frac{4}{\pi^2} \cdot \frac{\rho \cdot P}{p \cdot R_{20}} \cdot \frac{L}{15.28 \cdot 10^6}} \text{ [in]} \quad [13]$$

Example:

According to section 2

$$\rho = 1.35 \Omega \text{ mm}^2/\text{m} = (812 \Omega/\text{cmf}) \text{ for Kanthal D}$$

$$P = 1000 \text{ W}$$

$$p = 8 \text{ W/cm}^2 (51.6 \text{ W/in}^2)$$

$$R = 40 \Omega$$

According to equation [13]:

$$d = \sqrt[3]{\frac{4}{\pi^2} \cdot \frac{1.35 \cdot 1000}{8 \cdot 40} \cdot \frac{L}{10}} = 0.55 \text{ mm}$$

$$d = \sqrt[3]{\frac{4}{\pi^2} \cdot \frac{812 \cdot 1000}{51.6 \cdot 40} \cdot \frac{L}{15.28 \cdot 10^6}} =$$

$$= 0.022 \text{ inch}$$

B) Strip :

$$q = b \cdot t \quad [14]$$

C) Ribbon:

Since ribbons are made by flattening round wires, the cross-sectional area is somewhat smaller depending on size, than equation [14] indicates. As a rule of thumb, a factor 0.92 is used.

$$q = 0.92 \cdot b \cdot t \quad [15]$$

Lately, investigations have shown that a more correct way of expressing the cross-sectional area of ribbon is:

$$q = \left[0.985 - \left(\frac{t}{2 \cdot b} \right)^2 \right] \cdot b \cdot t \quad [15']$$

(Equation [15] is, however, used throughout this Handbook).

Definition:

Coil pitch, s [mm] or [in]

A round wire is often wound as a coil. For calculating coil pitch, s, the equation [16] applies:

$$\left(\frac{\pi \cdot (D - d)}{s} \right)^2 + 1 = \left(\frac{L}{L_e} \right)^2 \rightarrow$$

$$s = \frac{\pi \cdot (D - d)}{\sqrt{\left(\frac{L}{L_e} \right)^2 - 1}} \quad [16]$$

metric

$$s = \frac{\pi \cdot (D - d)}{\sqrt{\left(\frac{L \cdot 1000}{L_e} \right)^2 - 1}} \quad [16']$$

imperial

$$s = \frac{\pi \cdot (D - d)}{\sqrt{\left(\frac{L \cdot 12}{L_e} \right)^2 - 1}} \quad [16'']$$

When the pitch, s, is small relatively to coil diameter, D, and wire diameter, d.

Then $\frac{s}{\pi(D - d)} \ll L$, so that equation [16]

can be simplified to:

$$s = \frac{\pi \cdot (D - d) \cdot L_e}{L} \quad [17]$$

Relative pitch s/d

The ratio s/d is often used. It is called the relative pitch or the stretch factor, and may affect the heat dissipation from the coil.

$$r = \frac{s}{d} \quad [-]$$

The ratio D/d is essential for the coiling operation, as well as the mechanical stability of the coil in a hot state.

Example – wire calculation:

Calculate the resistance of a 3-foot-long KANTHAL D wire, 22 B & S (0.02535 in diameter).

Combining equation [1] and [12]:

$$R_{20} = \rho \frac{L}{q} \quad \text{and} \quad q = \frac{\pi}{4} \cdot d^2$$

$$R_{20} = \frac{\rho \cdot L \cdot 4}{\pi \cdot d^2}$$

$$\rho = 1.35 \, \Omega \text{ mm}^2/\text{m} = 812 \, \Omega/\text{cmf} = 637.79 \, \Omega/\text{smf}$$

$$L = 3 \text{ foot} = 3 \cdot 0.305 \text{ m}$$

$$d = 0.02535 \text{ in} = 25.35 \text{ mil} = 0.644 \text{ mm}$$

Metric units:

$$R_{20} = \frac{1.35 \cdot 3 \cdot 0.305 \cdot 4}{\pi \cdot 0.644^2} = 3.79 \, \Omega$$

Imperial units (cmf):

$$R_{20} = \frac{812 \cdot 3}{\pi \cdot (0.02535)^2}$$

$$R_{20} = \frac{812 \cdot 3}{25.35^2} = 3.79 \, \Omega$$

The unit Ω/smf is used principally for conductors with rectangular cross sections. Even here length is given in feet and width and thickness in mils.

Example – ribbon calculation:

Calculate the resistance of a KANTHAL D ribbon 10 feet long, where t = 0.04 in and b = 0.5 in.

Combining equation [1] and [14]:

$$R_{20} = \rho \frac{L}{q} \quad \text{and} \quad q = 0.92 \cdot b \cdot t$$

$$R_{20} = \frac{\rho \cdot L}{0.92 \cdot b \cdot t}$$

$$\rho = 1.35 \, \Omega \text{ mm}^2/\text{m} = 812 \text{ cmf}$$

$$L = 10 \text{ foot} = 10 \cdot 12 \text{ in} = 10 \cdot 0.305 \text{ m}$$

$$t = 0.04 \text{ in} = 40 \text{ mil} = 0.04 \cdot 25.4 \text{ mm} = 1.016 \text{ mm}$$

$$b = 0.5 \text{ in} = 500 \text{ mil} = 0.5 \cdot 25.4 \text{ mm} = 12.7 \text{ mm}$$

Metric units:

$$R_{20} = \frac{1.35 \cdot 10 \cdot 0.305}{0.92 \cdot 12.7 \cdot 1.016} = 0.346 \, \Omega$$

Imperial units (smf):

$$R_{20} = \frac{812 \cdot 10}{0.92 \cdot 500 \cdot 40 \cdot 1.2732} = 0.346 \, \Omega$$

3. Formulas for Values in Chapter 9, Tables

In the Kanthal handbook values **per meter** of the material in **each dimension** are calculated and presented in the table as **surface area, weight, resistance**.

Furthermore are the **cross sectional area** and **area /Ω** calculated.

Below you can see formulas used (formulas include the unit correction)

Metric units:

Cross sectional area q [mm²]

Based on equation [12] [14] res. [15]

Wire

$$q = \frac{\pi}{4} \cdot d^2 \quad [12']$$

Strip

$$q = b \cdot t \quad [14']$$

Ribbon

$$q = 0.92 \cdot b \cdot t \quad [15']$$

Surface area per meter A_{C/m} [cm²/m]

Based on equation [7] res. [8]

Wire

$$A_{C/m} = \pi \cdot d \cdot 10 \quad [7']$$

Strip/Ribbon

$$A_{C/m} = 2 \cdot (b + t) \cdot 10 \quad [8']$$

Weight per meter, m_m [g/m]

Wire

$$m = \text{volume} \cdot \gamma = q \cdot l \cdot \gamma \rightarrow m_m = q \cdot \gamma$$

Wire

$$m_m = \frac{\pi \cdot d^2 \cdot \gamma}{4} \quad [18]$$

Strip

$$m_m = b \cdot t \cdot \gamma \quad [18]$$

Ribbon

$$m_m = 0.92 \cdot b \cdot t \cdot \gamma \quad [18]$$

Resistance per meter R_{20/m} [Ω/m]

Based on equation [1]

$$R_{20/m} = \frac{\rho}{q} \quad [1']$$

Wire

$$R_{20/m} = \frac{\rho \cdot 4}{\pi \cdot d^2} \quad [1']$$

Strip

$$R_{20/m} = \frac{\rho}{b \cdot t} \quad [1']$$

Ribbon

$$R_{20/m} = \frac{\rho}{0.92 \cdot b \cdot t} \quad [1']$$

Surface area per Ω [cm^2/Ω]

Combining [1'] and [7'] respectively [1'] and [8']

Wire

$$\frac{A_{C/m}}{R_{20/m}} = \frac{\pi \cdot d \cdot q \cdot 10}{\rho} = \frac{\pi^2 \cdot d^3 \cdot 10}{\rho \cdot 4}$$

Strip

$$\begin{aligned} \frac{A_{C/m}}{R_{20/m}} &= \frac{2 \cdot (b+t) \cdot b \cdot t \cdot 10}{\rho} = \\ &= \frac{20 \cdot (b+t) \cdot b \cdot t}{\rho} \end{aligned}$$

Ribbon

$$\begin{aligned} \frac{A_{C/m}}{R_{20/m}} &= \frac{2 \cdot (b+t) \cdot 0.92 \cdot b \cdot t \cdot 10}{\rho} = \\ &= \frac{18.4 \cdot (b+t) \cdot b \cdot t}{\rho} \end{aligned}$$

Other equations which could be helpful**Length per kilo, L_{kg} [m/kg]**

Based on equation [18] $\rightarrow L_{\text{kg}} = \frac{1000}{m_m}$

Wire

$$L_{\text{kg}} = \frac{1000 \cdot 4}{\pi \cdot d^2 \cdot \gamma} = \frac{4000}{\pi \cdot d^2 \cdot \gamma} \quad [18']$$

Strip

$$L_{\text{kg}} = \frac{1000}{b \cdot t \cdot \gamma} \quad [18']$$

Ribbon

$$L_{\text{kg}} = \frac{1000}{0.92 \cdot b \cdot t \cdot \gamma} = \frac{1087}{b \cdot t \cdot \gamma} \quad [18']$$

Resistance per kilo, R_{kg} [Ω/kg]

Combining [1'] and [18] \rightarrow

$$R_{\text{kg}} = \frac{R_{20/m} \cdot 1000}{m_m} = \frac{\rho \cdot 1000}{q \cdot q \cdot \gamma} = \frac{\rho \cdot 1000}{q^2 \cdot \gamma}$$

Wire

$$R_{\text{kg}} = \frac{\rho \cdot 1000}{\left(\frac{\pi \cdot d^2}{4}\right)^2 \cdot \gamma} = \frac{\rho \cdot 1000}{\frac{\pi^2 \cdot d^4}{16} \cdot \gamma}$$

Strip

$$R_{\text{kg}} = \frac{\rho \cdot 1000}{b^2 \cdot t^2 \cdot \gamma}$$

Ribbon

$$R_{\text{kg}} = \frac{\rho \cdot 1000}{b^2 \cdot t^2 \cdot 0.92^2 \cdot \gamma} = \frac{\rho \cdot 1181.5}{b^2 \cdot t^2 \cdot \gamma}$$

Imperial units

$\rho'_{\text{wire}} = \Omega / \text{cir.mil foot}$ respectively
 $\rho'_{\text{strip/ribbon}} = \Omega / \text{square mil foot}$.

Cross sectional area q [in²]

Based on equation [12] [14] res. [15]

Wire

$$q = \frac{\pi}{4} \cdot d^2 \quad [12']$$

Strip

$$q = b \cdot t \quad [14']$$

Ribbon

$$q = 0.92 \cdot b \cdot t \quad [15']$$

Surface area per foot $A_{C/f\text{t}}$ [in²/ft]

Based on equation [7] res. [8]

Wire

$$A_{C/f\text{t}} = \pi \cdot d \cdot 12 \quad [7']$$

Strip/ribbon

$$A_{C/f\text{t}} = 2 \cdot (b + t) \cdot 12 = 24 \cdot (b + t) \quad [8']$$

Weight per foot [lb/ft]

$m = \text{volume} \cdot \gamma = q \cdot l \cdot \gamma \rightarrow m_{f\text{t}} = q \cdot \gamma$

Wire

$$m_{f\text{t}} = \frac{\pi \cdot d^2 \cdot \gamma \cdot 12}{4} = \pi \cdot d^2 \cdot \gamma \cdot 3 \quad [18']$$

Strip

$$m_{f\text{t}} = b \cdot t \cdot \gamma \cdot 12 \quad [18']$$

Ribbon

$$m_{f\text{t}} = 0.92 \cdot b \cdot t \cdot \gamma \cdot 12 = 11.04 \cdot b \cdot t \cdot \gamma \quad [18']$$

Resistance per foot $R_{20/f\text{t}}$ [Ω/ft]

Based on equation [1] $\rightarrow R_{20/f\text{t}} = \frac{\rho}{q}$

Wire

$$R_{20/f\text{t}} = \frac{\rho'}{d^2 \cdot 10^6} \quad [1']$$

Strip

$$R_{20/f\text{t}} = \frac{\rho''}{b \cdot t \cdot 10^6} \quad [1']$$

Ribbon

$$R_{20/f\text{t}} = \frac{\rho''}{0.92 \cdot b \cdot t \cdot 10^6} \quad [1']$$

Surface area per Ω [in²/ Ω]

Combining [1'] and [7'] respectively [1'] and [8']

Wire

$$\frac{A_{C/f\text{t}}}{R_{20/f\text{t}}} = \frac{\pi \cdot d^2 \cdot q \cdot 12 \cdot 10^6}{\rho'} = \frac{\pi^2 \cdot d^3 \cdot 3 \cdot 10^6}{\rho'}$$

Strip

$$\frac{A_{C/f\text{t}}}{R_{20/f\text{t}}} = \frac{2 \cdot (b + t) \cdot b \cdot t \cdot 12 \cdot 10^6}{\rho''} = \frac{24 \cdot (b + t) \cdot b \cdot t \cdot 10^6}{\rho''}$$

Ribbon

$$\frac{A_{C/f\text{t}}}{R_{20/f\text{t}}} = \frac{2 \cdot (b + t) \cdot 0.92 \cdot b \cdot t \cdot 12 \cdot 10^6}{\rho''} = \frac{22.08 \cdot (b + t) \cdot b \cdot t \cdot 10^6}{\rho''}$$

Other equations which could be helpful**Length per lb l_{lb} [ft/lb]**

Based on equation [18] $\rightarrow l_{lb} = \frac{1}{m_{ft}}$

Wire

$$l_{lb} = \frac{4}{\pi \cdot d^2 \cdot \gamma \cdot 12} = \frac{1}{\pi \cdot d^2 \cdot \gamma \cdot 3} \quad [18']$$

Strip

$$l_{lb} = \frac{1}{b \cdot t \cdot \gamma \cdot 12} \quad [18']$$

Ribbon

$$l_{lb} = \frac{1}{0.92 \cdot b \cdot t \cdot \gamma \cdot 12} = \frac{1}{b \cdot t \cdot \gamma \cdot 11.04} \quad [18']$$

Resistance per lb R_{lb} [Ω /lb]

Combining [1'] and [18] \rightarrow

$$R_{lb} = \frac{R_{20/f}}{m_{ft}} = \frac{\rho}{q \cdot q \cdot \gamma} = \frac{\rho}{q^2 \cdot \gamma}$$

Wire

$$R_{lb} = \frac{\rho'}{d^2 \cdot 10^6 \cdot \pi \cdot d^2 \cdot \gamma \cdot 3} =$$

$$= \frac{\rho'}{d^4 \cdot 10^6 \cdot \pi \cdot \gamma \cdot 3}$$

Strip

$$R_{lb} = \frac{\rho''}{b^2 \cdot t^2 \cdot \gamma \cdot 12 \cdot 10^6}$$

Ribbon

$$R_{lb} = \frac{\rho''}{b^2 \cdot t^2 \cdot 0.92^2 \cdot \gamma \cdot 12 \cdot 10^6} =$$

$$= \frac{\rho''}{b^2 \cdot t^2 \cdot 10.16 \cdot \gamma \cdot 10^6}$$

4. Relationship between metric and imperial units

Metric and imperial sytem conversion table

$$1 \Omega\text{mm}^2\text{m}^{-1} (\mu\Omega\text{m}) = 601.54 \Omega/\text{cmf}$$

$$1 \Omega\text{mm}^2\text{m}^{-1} (\mu\Omega\text{m}) = 472.44 \Omega/\text{smf}$$

$$1 \Omega/\text{smf} = 1.2732 \Omega/\text{cmf}$$

$$1 \text{ inch [in]} = 1000 \text{ mil} = 0.0254 \text{ m}$$

$$1 \text{ foot} = 12 \text{ in} = 0.3048 \text{ m}$$

$$1 \text{ mil} = 0.001 \text{ inch} = 0.0254 \text{ mm}$$

$$1 \text{ W/cm}^2 = 6.45 \text{ W/in}^2$$

$$1 \text{ W/in}^2 = 0.155 \text{ W/cm}^2$$

5. Design Calculations for Heating Elements

In this section an element is defined as the combination of heating wire and any supporting and connecting materials. Electrical appliances equipped with a heating element are being used in domestic as well as industrial applications. Domestic applications are e.g. cooking, heating of fluids, drying, ironing, space heating and special purposes such as heating of beds, aquariums, saunas, soldering irons and paint strippers. Industrial applications are such as heat treatment, hardening and drying of inks, paints and lacquers. In vehicles, seats, motors and rear view mirrors are frequently electrically heated.

The appliance and the element must meet requirements regarding performance, cost of raw material and manufacture, life and safety. The requirements may be opposed to each other. A long life and a high degree of safety means a low wire temperature, which results in a long heating up time and often also high raw material costs.

Domestic heating appliances must not cause harm to individuals or damage to property. Safety specifications for each market may influence the design of the appliance and the element and limit their temperature.

The life of a well designed element depends upon the make and the type of wire used. Our FeCrAl and NiCr(Fe) wires have excellent properties at high temperature and provide the best possible life. It should be kept in mind that the life of a wire increases with wire diameter and decreasing wire temperature.

Wire Temperature

For embedded and supported element types the wire temperature depends upon both the wire and the element surface load. For the suspended element types the element surface load in most cases cannot be defined. In addition to the surface load, ambient temperature, heating dissipating conditions and presence and location of other elements will influence the wire temperature and therefore also the choice of wire surface load and element surface load.

Life test of elements.



Surface Load

When calculating an element, voltage and rating are normally known. The element surface load means the rating divided by that part of element surface, which is close to the energised wire and therefore has an elevated temperature. Usually a range of surface loads and not one single figure is listed in the mentioned tables. The choice within the range depends upon the requirements for the element. It also depends upon voltage, rating and dimensions available. A high voltage and a low rating will result in a thin wire, which at the same temperature has a shorter life than a thick wire and will therefore require a low wire surface load.

The wire surface is then found as the ratio between rating and wire surface load.

Surface and Resistance

After having calculated the resistance in cold state, the ratio between the surface and the resistance is found. This ratio is listed for all wire types and wire dimensions in the Kanthal handbook, and the correct wire size can therefore easily be found from these tables.

Life test of 4 mm wire.

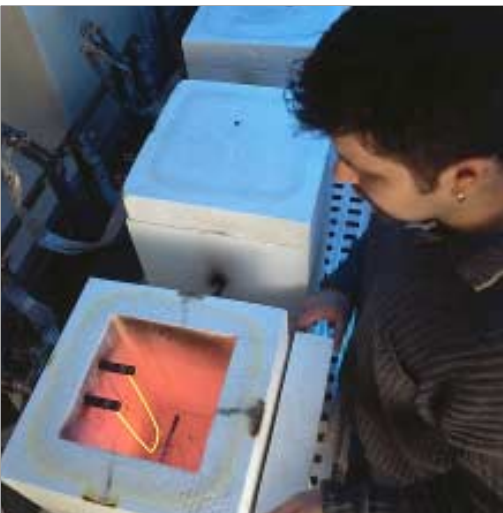

Bash test of alloys.

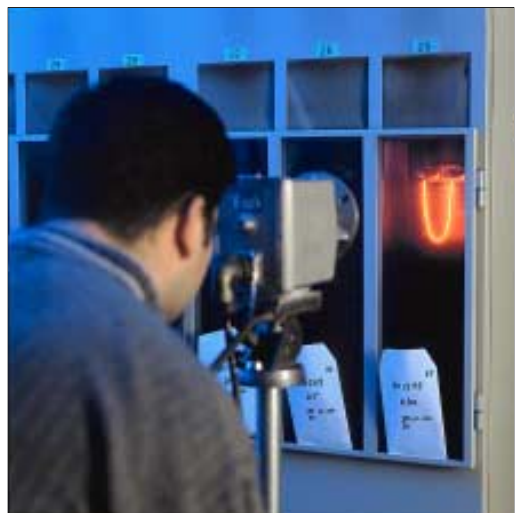

Coil Parameters

The ratio between coil and wire diameter (D/d) must be calculated in order to check that the coil can easily be made. This ratio (D/d) should be in the range 5-12 if possible. In case of supported elements, this ratio must be compared with the deformation curve in Figure 3, page 23. When the coil length and diameter are known, the coil pitch (s) can be estimated by formula [17] in the Appendix. Coil pitch (s) is normally 2-4 times the wire diameter (d). For quartz tube heaters a smaller pitch is normally used. Preoxidised coils from KANTHAL FeCrAl in such elements can be used tightly coiled.

For a straight wire on a threaded ceramic rod and for many elements of the suspended type the wire length is fixed. The resistance per meter can then be calculated and the wire size found from the tables of the Kanthal handbook. If this results in too high a surface load in case of a ribbon, a wider and thinner ribbon having the same cross section can be chosen.

Metal Sheathed Tubular Element

The calculation of a metal sheathed tubular element is more complicated since the resistance is reduced 10 to 30 % as a result of the compression of the element. For such elements, the tube surface load is first determined according to the use of the element. The wire surface load is normally 2 to 4 times greater. After calculating the resistance from rating and voltage, it has to be increased 10 to 30 % in order to arrive at the resistance after coiling. The wire surface will become 2 to 7 % smaller when the element has been reduced. Since the tube length is increased through compression by rolling, the tube surface often remains unaltered.

Glowing coil inside tubular heating element.

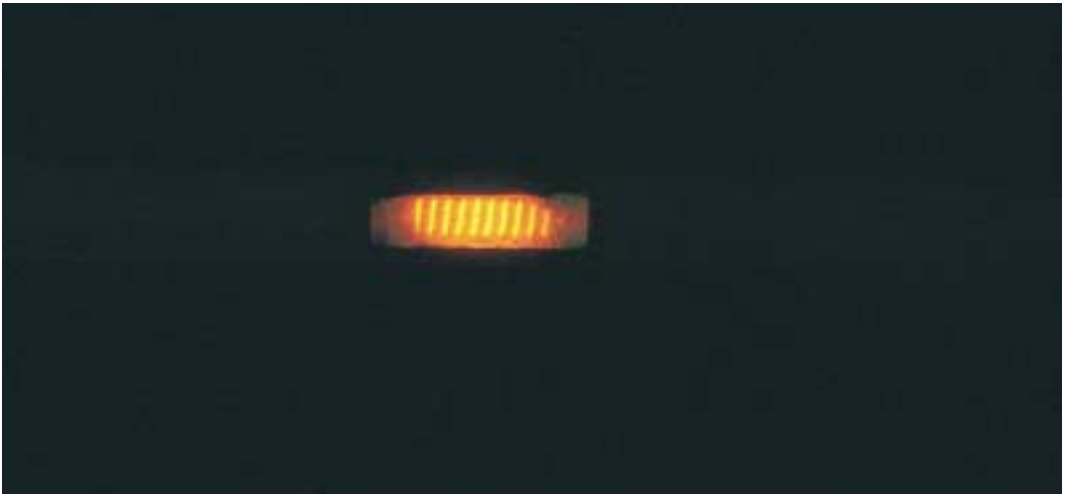

Examples

Tubular Element for a Flat Iron

Rating, P	1000 W
Voltage, U	220 V
Final tube diameter:	8 mm (0.315 in)
Final tube length:	300 mm (11.8 in)

If the terminal length inside the tube is 2 x 25 mm (2 x 1 in) the coil length (L_c) will be $L_c = 300 \text{ mm} - (2 \times 25 \text{ mm}) = 250 \text{ mm}$ (9.8 in). Combining equation [9] and [10] gives as hot resistance

$$R = \frac{U^2}{P} = \frac{220^2}{1000} = 48.4 \Omega$$

According to equation [6] tubes surface load becomes

$$P_{\text{tube}} = \frac{P}{A_{\text{tube}}} = \frac{P}{\pi \cdot d_{\text{tube}} \cdot L_c \cdot 0.01} = \frac{1000}{\pi \cdot 8 \cdot 250 \cdot 0.01} = 15.91 \frac{\text{W}}{\text{cm}^2} = (103 \text{ W/in}^2)$$

If we aim at three times higher wire surface load:

$$P_{\text{wire}} = 3 \cdot P_{\text{tube}} = 3 \cdot 15.91 = 47.74 \approx 48 \frac{\text{W}}{\text{cm}^2} (309 \text{ W/in}^2)$$

According to equation [6] the wire surface can be calculated to

$$P = \frac{P}{A_c}$$

$$A_c = \frac{P}{p} = \frac{1000}{48} = 20.83 \approx 21 \text{ cm}^2 (3.3 \text{ in}^2)$$

KANTHAL D is a sensible choice and an average wire temperature of 700 °C (1290 °F) likely. Due to temperature factor of resistance (C_t for Kanthal D, table chapter 2, = 1.05) the resistance at room temperature is based on [2] calculated to:

$$R_T = C_t \cdot R_{20} \rightarrow R_{20} = \frac{R_T}{C_t} = \frac{48.4}{1.05} = 46.09 \approx 46.1 \Omega$$

The ratio wire surface to resistance is

$$\frac{A_C}{R_{20}} = \frac{21}{46.1} = 0.455 \frac{\text{cm}^2}{\Omega}$$

corresponding to a wire size of about 0.3 mm (0.012 in), based on the table for KANTHAL D in chapter 9.

Coils in grooved metal plates.



Metal sheathed tubular element.



We assume that a steel tube of initially 9.5 mm (0.37 in) diameter is being used and can then expect a resistance reduction of about 30 % upon rolling. The resistance of the coil should therefore be about 65.3 Ω. The wire surface prior to compression is 7 % bigger, or 22.5 cm² (3.49 in²), and the ratio between wire surface and resistance 0.34 cm²/Ω (0.053 in²/Ω).

The corresponding wire size is 0.26 mm (0.01 in). Tests with this wire size have to be made in order to check the resistance reduction as a result of compression.

Coil suspended on a Mica-cross, element for a hair dryer

Rating, P	350W
Voltage, U	55 V
Length of coil, l	250 mm
Coil outer diameter, D	6 mm

For this application a surface load, p, of 7 W/cm² is reasonable, using equation [6] gives a wire surface of:

$$p = \frac{P}{A_c} \rightarrow A_c = \frac{P}{p} = \frac{350}{7} = 50 \text{ cm}^2$$

Assuming a wire temperature of 600 °C and choosing Kanthal D with an Ct value of 1.04. Next step is to calculate hot- and cold resistance, according to combining equation [9], [10] and [2]:

$$R_T = \frac{U_2}{P} = \frac{55^2}{350} = 8.64 \text{ } \Omega$$

$$R_{20} = \frac{R_T}{C_t} = 8.31 \text{ } \Omega$$

By calculating the surface area to cold resistance ratio, a suitable wire dimension is found:

Combining [1'] and [7'], [8']

Wire

$$\frac{A_c}{R_{20}} = \frac{50 \text{ cm}^2}{8.31 \text{ } \Omega} = 6.01 \frac{\text{cm}^2}{\Omega}$$

According to the table in chapter 9, Kanthal D Ø 0.70 mm has an area to resistance ratio of 6.27 cm²/Ω.

Verifying the geometry of the coil, suitable values for the D/d ratio are between 6-12.

D/d ratio has to be considered since too low as well as too high values will create problems in the coiling process. In this case:

$$\frac{D}{d} = \frac{6 \text{ mm}}{0.7 \text{ mm}} = 8.6 \text{ which is within limits}$$

To get the length of wire we have to calculate the ratio between resistance needed and resistance per meter according to table chapter 9, KANTHAL D, d = 0.7 mm

$$R_{20/m} = 3.51 \text{ } \Omega/\text{m.}$$

The length of the wire becomes:

$$L = \frac{R_{20}}{R_{20/m}} = \frac{8.31 \text{ } \Omega \cdot \text{m}}{3.51 \text{ } \Omega} = 2.367 \text{ m}$$

Based on [17] the coil pitch, s, is calculated to:

$$s = \frac{\pi \cdot (D - d) \cdot L_e}{L} = \frac{\pi \cdot (7 - 0.7) \cdot 250}{2370} = 2.09 \text{ mm}$$

and subsequently a relative pitch:

$$r = \frac{s}{d} = \frac{2.09}{0.7} = 2.98$$

Finally the actual surface load is based on [6] calculated to:

$$p = \frac{P}{A_{c/m} \cdot L} = \frac{350}{22 \cdot 2.37} = 6.7 \text{ W/cm}^2$$

6. Wire Gauge Conversion Table

Gauge no.	AWG or B&S		SWG	
	inch	mm	inch	mm
4-0	0.4600	11.684	0.4000	10.1600
3-0	0.4096	10.404	0.3720	9.4488
2-0	0.3648	9.266	0.3480	8.8392
0	0.3249	8.252	0.3240	8.2296
1	0.2893	7.348	0.3000	7.6200
2	0.2576	6.543	0.2760	7.0104
3	0.2294	5.827	0.2520	6.4008
4	0.2043	5.189	0.2320	5.8928
5	0.1819	4.620	0.2120	5.3848
6	0.1620	4.115	0.1920	4.8768
7	0.1443	3.665	0.1760	4.4704
8	0.1285	3.264	0.1600	4.0640
9	0.1144	2.906	0.1440	3.6576
10	0.1019	2.588	0.1280	3.251
11	0.09074	2.305	0.1160	2.946
12	0.08081	2.053	0.1040	2.642
13	0.07196	1.828	0.0920	2.337
14	0.06408	1.628	0.0800	2.032
15	0.05707	1.450	0.0720	1.829
16	0.05082	1.291	0.0640	1.626
17	0.04526	1.150	0.0560	1.422
18	0.04030	1.024	0.0480	1.219
19	0.03589	0.912	0.0400	1.016
20	0.03196	0.812	0.0360	0.914
21	0.02846	0.723	0.0320	0.813
22	0.02535	0.644	0.0280	0.711
23	0.02257	0.573	0.0240	0.610
24	0.02010	0.511	0.0220	0.559
25	0.01790	0.455	0.0200	0.508
26	0.01594	0.405	0.0180	0.457
27	0.01420	0.361	0.0164	0.417
28	0.01264	0.321	0.0148	0.376

Gauge no.	AWG or B&S		SWG	
	inch	mm	inch	mm
29	0.01126	0.286	0.0136	0.345
30	0.01003	0.255	0.0124	0.315
31	0.008928	0.227	0.0116	0.295
32	0.007950	0.202	0.0108	0.274
33	0.007080	0.180	0.0100	0.254
34	0.006305	0.160	0.00920	0.234
35	0.005615	0.143	0.00840	0.213
36	0.005000	0.127	0.00760	0.193
37	0.004453	0.113	0.00680	0.173
38	0.003965	0.101	0.00600	0.152
39	0.003531	0.0897	0.00520	0.132
40	0.003145	0.0799	0.00480	0.122
41	0.002800	0.0711	0.00440	0.112
42	0.002494	0.0633	0.00400	0.102
43	0.002221	0.0564	0.00360	0.0914
44	0.001978	0.0502	0.00320	0.0813
45	0.001761	0.0447	0.00280	0.0711
46	0.001568	0.0398	0.00240	0.0610
47	0.001397	0.0355	0.00200	0.0508
48	0.001244	0.0316	0.00160	0.0406
49	0.001108	0.0281	0.00120	0.0305
50	0.000986	0.0250	0.00100	0.0254
51	0.000800	0.0203	0.000878	0.0223
52	0.000600	0.0152	0.000782	0.0199
53	0.000500	0.0127	0.000697	0.0177
54	0.000400	0.0102	0.000620	0.0157
55	0.000300	0.0076	0.000552	0.0140
56			0.000492	0.0125
57			0.000438	0.0111
58			0.000390	0.00991
59			0.000347	0.00881
60			0.000309	0.00785

7. Temperature Conversion Table

The numbers in the light shaded area indicate the temperatures as read. The corresponding temperatures in Fahrenheit are given on the right and those in Celsius on the left.

If 10 degrees are read in Celsius, look in the right column and convert it to 50 °F. If 10 degrees F is read, look in the left column and convert it to -12,2 °C.

°C		°F
-17.8	0	32
-17.2	1	33.8
-16.7	2	35.6
-16.1	3	37.4
-15.6	4	39.2
-15.0	5	41.0
-14.4	6	42.8
-13.9	7	44.6
-13.3	8	46.4
-12.8	9	48.2
-12.2	10	50.0
-11.7	11	51.8
-11.1	12	53.6
-10.6	13	55.4
-10.0	14	57.2
-9.44	15	59.0
-8.89	16	60.8
-8.33	17	62.6
-7.78	18	64.4
-7.22	19	66.2
-6.67	20	68.0
-6.11	21	69.8
-5.56	22	71.6
-5.00	23	73.4
-4.44	24	75.2
-3.89	25	77.0
-3.33	26	78.8
-2.78	27	80.6
-2.22	28	82.4
-1.67	29	84.2
-1.11	30	86.0
-0.56	31	87.8
0	32	89.6
0.56	33	91.4
1.11	34	93.2
1.67	35	95.0
2.22	36	96.8
2.78	37	98.6
3.33	38	100.4
3.89	39	102.2
4.44	40	104.0
5.00	41	105.8
5.56	42	107.6

°C		°F
6.11	43	109.4
6.67	44	111.2
7.22	45	113.0
7.78	46	114.8
8.33	47	116.6
8.89	48	118.4
9.44	49	120.2
10.0	50	122.0
10.6	51	123.8
11.1	52	125.6
11.7	53	127.4
12.2	54	129.2
12.8	55	131.0
13.3	56	132.8
13.9	57	134.6
14.4	58	136.4
15.0	59	138.2
15.6	60	140.0
16.1	61	141.8
16.7	62	143.6
17.2	63	145.4
17.8	64	147.2
18.3	65	149.0
18.9	66	150.8
19.4	67	152.6
20.0	68	154.4
21.1	70	158.0
21.7	71	159.8
22.2	72	161.6
22.8	73	163.4
23.3	74	165.2
23.9	75	167.0
24.4	76	168.8
25.0	77	170.6
25.6	78	172.4
26.1	79	174.2
26.7	80	176.0
27.2	81	177.8
27.8	82	179.6
28.3	83	181.4
28.9	84	183.2
29.4	85	185.0
30.0	86	186.8

°C		°F
30.6	87	188.6
31.1	88	190.4
31.7	89	192.2
32.2	90	194.0
32.8	91	195.8
33.3	92	197.6
33.9	93	199.4
34.4	94	201.2
35.0	95	203.0
35.6	96	204.8
36.1	97	206.6
36.7	98	208.4
37.2	99	210.2
38	100	212
43	110	230
49	120	248
54	130	266
60	140	284
66	150	302
71	160	320
77	170	338
82	180	356
88	190	374
93	200	392
99	210	410
100	212	413
104	220	428
110	230	446
116	240	464
121	250	482
127	260	500
132	270	518
138	280	536
143	290	554
149	300	572
154	310	590
160	320	608
166	330	626
171	340	644
177	350	662
182	360	680
188	370	698
193	380	716

cont.

°C		°F	°C		°F	°C		°F
199	390	734	482	900	1652	766	1410	2570
204	400	752	488	910	1670	771	1420	2588
210	410	770	493	920	1688	777	1430	2606
216	420	788	499	930	1706	782	1440	2624
221	430	806	504	940	1724	788	1450	2842
227	440	824	510	950	1742	793	1460	2660
232	450	842	516	960	1760	799	1470	2678
238	460	860	521	970	1778	804	1480	2696
243	470	878	527	980	1796	810	1490	2714
254	490	914	532	990	1814	816	1500	2732
260	500	932	538	1000	1832	821	1510	2750
266	510	950	543	1010	1850	827	1520	2768
271	520	968	549	1020	1868	832	1530	2786
277	530	986	554	1030	1886	838	1540	2804
282	540	1004	560	1040	1904	843	1550	2822
288	550	1022	566	1050	1922	849	1560	2840
293	560	1040	571	1060	1940	854	1570	2858
299	570	1058	577	1070	1958	860	1580	2876
304	580	1076	582	1080	1976	866	1590	2894
310	590	1094	588	1090	1994	871	1600	2912
316	600	1112	593	1100	2012	877	1610	2930
321	610	1130	599	1110	2030	882	1620	2948
327	620	1148	604	1120	2048	888	1630	2966
332	630	1166	610	1130	2066	893	1640	2984
338	640	1184	616	1140	2084	899	1650	3002
343	650	1202	621	1150	2102	904	1660	3020
349	660	1220	627	1160	2120	910	1670	3038
354	670	1238	632	1170	2138	916	1680	3056
360	680	1256	643	1190	2174	921	1690	3074
366	690	1274	649	1200	2192	927	1700	3092
371	700	1292	654	1210	2210	932	1710	3110
377	710	1310	660	1220	2228	938	1720	3128
382	720	1328	666	1230	2246	943	1730	3146
388	730	1346	671	1240	2264	949	1740	3164
393	740	1364	677	1250	2282	954	1750	3182
399	750	1382	682	1260	2300	960	1760	3200
404	760	1400	688	1270	2318	966	1770	3218
410	770	1418	693	1280	2336	971	1780	3236
416	780	1436	699	1290	2354	977	1790	3254
421	790	1454	704	1300	2372	982	1800	3272
427	800	1472	710	1310	2390	988	1810	3290
432	810	1490	716	1320	2408	993	1820	3308
438	820	1508	721	1330	2426	999	1830	3326
443	830	1526	727	1340	2444	1004	1840	3344
449	840	1544	732	1350	2462	1010	1850	3362
454	850	1562	738	1360	2480	1016	1860	3380
460	860	1580	743	1370	2498	1021	1870	3398
468	870	1598	749	1380	2516	1032	1890	3434
471	880	1816	754	1390	2534	1038	1900	3452
477	890	1634	760	1400	2552	1043	1910	3470

cont.

cont.

°C		°F
1049	1920	3488
1054	1930	3506
1060	1940	3524
1066	1950	3542
1071	1960	3560
1077	1970	3578
1082	1980	3596
1088	1990	3614
1093	2000	3632
1099	2010	3650
1104	2020	3668
1110	2030	3686
1116	2040	3704
1121	2050	3722
1127	2060	3740
1132	2070	3758
1138	2080	3776
1143	2090	3794
1149	2100	3812
1154	2110	3830
1160	2120	3848
1166	2130	3866
1171	2140	3884
1177	2150	3902
1182	2160	3920
1188	2170	3938
1193	2180	3956
1199	2190	3974
1204	2200	3992
1210	2210	4010
1216	2220	4028
1221	2230	4046
1227	2240	4064
1232	2250	4082
1238	2260	4100
1243	2270	4118

°C		°F
1249	2280	4138
1254	2290	4154
1260	2300	4172
1266	2310	4190
1271	2320	4208
1277	2330	4226
1282	2340	4244
1288	2350	4262
1293	2360	4280
1299	2370	4298
1304	2380	4316
1310	2390	4334
1316	2400	4352
1321	2410	4370
1327	2420	4388
1332	2430	4406
1338	2440	4424
1343	2450	4442
1349	2460	4460
1354	2470	4478
1360	2480	4496
1366	2490	4514
1371	2500	4532
1377	2510	4550
1382	2520	4568
1388	2530	4586
1393	2540	4604
1399	2550	4622
1404	2560	4640
1410	2570	4658
1421	2590	4694
1427	2600	4712
1432	2610	4730
1438	2620	4748
1443	2630	4766
1449	2640	4784

°C		°F
1454	2650	4802
1460	2660	4820
1466	2670	4838
1471	2680	4856
1477	2690	4874
1482	2700	4892
1488	2710	4910
1493	2720	4928
1499	2730	4946
1504	2740	4964
1510	2750	4982
1516	2760	5000
1521	2770	5018
1527	2780	5036
1532	2790	5054
1538	2800	5072
1543	2810	5090
1549	2820	5108
1554	2830	5126
1560	2840	5144
1566	2850	5162
1571	2860	5180
1577	2870	5198
1582	2880	5216
1588	2890	5234
1593	2900	5252
1599	2910	5270
1604	2920	5288
1610	2930	5306
1616	2940	5324
1621	2950	5342
1627	2960	5360
1632	2970	5378
1638	2980	5396
1643	2990	5414
1649	3000	5432

Interpolation table

°C		°F
0.56	1	1.8
1.11	2	3.6
1.67	3	5.4
2.22	4	7.2
2.78	5	9.0
3.33	6	10.8
3.89	7	12.6
4.44	8	14.4
5.00	9	16.2
5.56	10	18.0

8. Miscellaneous Conversion Factors

To Convert from:	To:	Multiply by:
ampere-turns	gilberts	1.2566
atmospheres	torr	760.00
btu's	kilogram-calories	0.25200
btu's	foot-pounds	778.17
btu's	horsepower-hours	0.00039308
btu's	joules	1054.0
btu's	kilogram-meters	107.59
btu's	kilowatt-hours	0.00029307
btu's	gram-calories	252.00
btu's	watt-hours	0.29307
btu's/hour	watts	0.29307
btu's/minute	watts	17.584
btu's/minute	foot-pounds/sec	12.961
btu's/sq ft	watt-hours/sq meter	3.1546
btu's/(sq ft)(min)	watts/sq inch	0.12203
btu's/(hr)(sq ft)	watts/sq meter	3.1525
btu's/(hr)(sq ft)(øF)	gm-cals/(sec)(sq m)(øC)	1.3562
calories	joules	4.1840
Centigrade	Fahrenheit	$1.8 \times (^{\circ}\text{C} + 32)$
centipoise	pascal-seconds	0.001
circular mils	square centimeters	0.000005067
circular mils	square inches	0.0000007854
circular mils	square mils	0.78540
cubic cm	cubic inches	0.061024
degrees (angle)	radians	0.017453
degrees/sec	revolutions/min	0.16667
dynes	grams	0.0010197
dynes	newtons	0.00001
dynes	pounds	0.0000022481
dynes/sq cm	kgs/sq meter	0.010197
dynes/sq cm	pounds/sq foot	0.0020885
dynes/sq cm	pounds/sq inch	0.000014503
Fahrenheit	Centigrade	$0.555 \times (^{\circ}\text{F} - 32)$
fathoms	feet	6
foot-pounds	horsepower-hours	0.00000050505
foot-pounds	joules	1.3558
foot-pounds	newton-meters	1.3558
foot-pounds	kilogram-calories	0.00032383
foot-pounds	kilogram-meters	0.13826
foot-pounds	kilowatt-hours	0.00000037662
foot-pounds/min	horsepower	0.000030303
foot-pounds/min	kilowatts	0.000022597
foot-pounds/sec	horsepower	0.0018182
foot-pounds/sec	kg-calories/min	0.019443

To Convert from:	To:	Multiply by:
foot-pounds/sec	kilowatts	0.0013558
furlongs	miles	0.125
gallons (U.S.)	gallons (Brit.)	0.83267
gallons	liters	3.7854
gallons	pints (liquid)	8
gallons	quarts (liquid)	4
gallons/min	cubic feet/sec	0.0022280
gallons/min	liters/sec	0.063090
gauss	lines/sq inch	6.4516
gauss	webers/sq meter	0.0001
grams	ounces	0.035274
grams	ounces (troy)	0.032151
grams	poundals	0.070932
grams	pounds	0.0022046
gram-centimeters	btu's	0.0000009301
gram-centimeters	foot-pounds	0.000072330
gram-centimeters	joules	0.000098067
gram-centimeters	kilogram-meters	0.00001
grams/cm	pounds/inch	0.0055997
grams/cu cm	pounds/cu foot	62.428
grams/cu cm	pounds/cu inch	0.036127
grams/cu cm	pounds/circ mil foot	0.00000034049
horsepower (electric)	horsepower (metric)	1.0143
horsepower	kg-calories/min	10.686
horsepower	horsepower (metric)	1.0139
horsepower	kilowatts	0.7457
horsepower	watts	745.7
horsepower-hours	joules	2684520
horsepower-hours	kilogram-calories	641.19
horsepower-hours	kilogram-meters	273745
hours	seconds	3600
inches	centimeters	2.54
inches	mils	1000
inches	millimeters	25.4
joules	kilogram-calories	0.00023866
joules	volt-coulombs	0.99984
joules	watt-hours	0.00027778
joules	watt-seconds	1
kilograms	dynes	980665
kilograms	poundals	70.932
kilograms	pounds	2.2046
kilograms	pounds (troy)	2.6792
kilograms	tons (short)	0.0011023
kilograms	tons (long)	0.00098421
kilogram-calories	kilogram-meters	426.93

To Convert from:	To:	Multiply by:
kilogram-calories	kilowatt-hours	0.001163
kg-cals/minute	kilowatts	0.06978
kilogram-meters	kilowatt-hours	0.000027241
kgs/cu meter	grams/cu cm	0.001
kgs/cu meter	pounds/cu foot	0.062428
kgs/cu meter	pounds/cu inch	0.000036127
kgs/meter	pounds/foot	0.67197
kgs/sq centimeter	pounds/sq inch	14.223
kgs/sq meter	pounds/sq foot	0.20482
kgs/sq meter	pounds/sq inch	0.0014223
kilopascals	pounds/sq in	0.14504
kilowatt	btu's/min	56.878
kilowatt-hours	btu's	3413
kilowatt-hours	horsepower-hours	1.3410
kilowatt-hours	kilogram-calories	860
kilowatt-hours	joules	3600000
liter	cubic cm	1000
liter	cubic inches	61.023
liters	quarts (liquid)	1.0567
liters/minute	cubic feet/sec	0.00058858
liters/minute	gallons/sec	0.0044029
meters	inches	39.370
meters	kilometers	0.001
meters	yards	1.0936
meter-kilograms	pound-feet	7.2330
meters/second	miles/hour	2.2369
meters/second	feet/minute	196.85
meters/second	kilometers/hour	3.6
meters/second	miles/minute	0.037282
micrograms	grams	0.000001
microhms	ohms	0.000001
microinches	inches	0.000001
microinches	microns	25.4
microinches	millimeters	0.0254
microliters	liters	0.000001
microns	inches	0.000039370
microns	meters	0.000001
microns	millimeters	0.001
miles	feet	5280
millibars	torr	0.75006
millibars	pascals	100
millihenries	henries	0.001
millimeters	mils	39.370
nautical miles	kilometers	1.852
newtons	pounds	0.22481

To Convert from:	To:	Multiply by:
oersteds	amperes/meter	79.577
ohm - circular mil/foot	ohm - square mil/foot	1.273
ohm - circular mil/foot	ohm - square mm/meter	0.00166
ohm - circular mil/foot	microhm cm	0.16624
ohms/foot	ohms/meter	3.2808
ounces	pounds	0.0625
ounces (fluid)	cubic inches	1.8047
ounces (fluid)	liters	0.02957
ounces (troy)	grains	480
ounces (troy)	pounds (troy)	0.083333
pound	grams	453.59
pound	grains	7000
pound	kilograms	0.45359
pounds (troy)	pounds (avdp)	0.82286
pounds/sq foot	pounds/sq inch	0.0069444
pounds/sq inch	newton/sq meter	6894.8
pounds/cubic foot	kilograms/cubic meter	16.019
pounds/cubic inch	grams/cubic cm	27.680
radians	revolutions	0.15915
radians/sec	revolutions/min	9.5493
slugs	kilograms	14.594
square centimeters	square inches	0.15500
square feet	square meters	0.092903
square millimeters	circular mils	1973.5
square mils	circular mils	1.2732
square mils	square centimeters	0.0000064516
square mils	square inches	0.000001
stones	pounds	14
watts	ergs/second	10000000
watts	foot-pounds/min	44.254
watts	foot-pounds/sec	0.73756
watts	kg-calories/min	0.014331
watt-hours	foot-pounds	2655.2
watt-hours	kilogram-calories	0.85985

11. The Kanthal Product Range

Heating Alloys

Appliance Wire 0.12-2 mm *0.00468-0.078 in Ribbon*

The heating source in most electric household appliances such as ovens, toasters, hair dryers, washing machines etc.

Industrial Wire 1-10 mm *0.039-0.47 in Strip*

For heating elements in industrial furnaces and processes.

Alloy	Max temperature
KANTHAL APM	1425 °C 2595 °F
KANTHAL A-1	1400 °C 2550 °F
KANTHAL A	1350 °C 2460 °F
KANTHAL AE	1300 °C 2370 °F
KANTHAL AF	1300 °C 2370 °F
KANTHAL D	1300 °C 2370 °F
ALKROTHAL	1100 °C 2010 °F
NIKROTHAL 80	1200 °C 2190 °F
NIKROTHAL 70	1250 °C 2280 °F
NIKROTHAL 60	1150 °C 2100 °F
NIKROTHAL 40	1100 °C 2010 °F
NIFETHAL 70	600 °C 1110 °F
NIFETHAL 52	600 °C 1110 °F



Precision Wire

Precision Wire 0.015-0.12 mm *0.000585-0.00468 in*

Is used in electronic components such as resistors and potentiometers and for low temperature heating.

Special Alloys

Alloys for thermocouples, extension and compensating cables.

- Nickel-iron.
- Controlled expansion alloys.
- High temperature alloys for mechanical applications.
- Copper-nickel alloys for special applications.

Precision wire 0.015 mm in the eye of a needle.



Thermostatic Bimetal

Bimetal consists of two or more metallic strips with different thermal expansion bonded together. When heated up it bends in a pre-determined manner and can be used to monitor, measure or regulate heat. Its main applications are in thermostats for room heaters or water mixing but they are also used to control toasters and indicators in automobiles.

Kanthal offers a wide range of some 30 standard types of thermostatic Bimetal with different specific deflection, manufactured in widths ranging between 170 and 1.0 mm *6.63 - 0.039 in* and in thickness between 2.5 and 0.10 mm *0.097 - 0.0039 in*. Bimetal is also manufactured to specifications suitable for the snap action disc applications.

Thermostatic Bimetal.



Kanthal Super

High power and long life electric heating elements for use up to very high temperatures. Manufactured as ready-made elements, straight or bent in a broad range of standard dimensions. Used mainly in laboratory furnaces and production furnaces in the glass-, electronics-, steel-, ceramics and heat treatment industry.

Quality	Max temperature
Kanthal Super 1700	1700 °C 3090 °F
Kanthal Super 1800	1800 °C 3270 °F
Kanthal Super 1900	1850 °C 3360 °F
Kanthal Super HT	1830 °C 3330 °F
Kanthal Super RA	1700 °C 3090 °F
Kanthal Super ER	1600 °C 2910 °F
Kanthal Super NC	1800 °C 3270 °F

SUPERTHAL®

Heating modules with Kanthal Super elements and ceramic fibre in the form of half-cylinders, cylinders, panels or completely tailor made for use up to 1550 °C 2820 °F. Supertal is used wherever concentrated heat is needed, for example in the electronics- and the glass industry as well as in dental furnaces.

Kanthal Super and Supertal



Metallic Elements

Ready-made furnace elements manufactured in Kanthal workshops from KANTHAL or NIKROTHAL alloys for furnace temperatures between 50 °C – 1350 °C 120 – 2460 °F.

FIBROTHAL®

A complete modular system comprising heating elements and insulation for furnaces and processes up to 1200 °C 2190 °F.

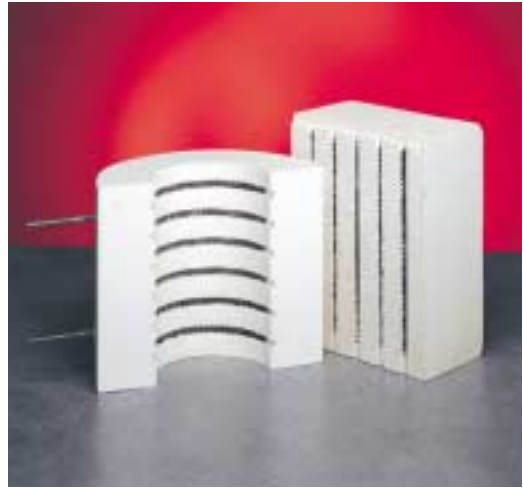

FIBROTHAL.

Metallic elements manufacturing.



TUBOTHAL®

Powerful metallic element heaters for use inside all types of radiant tubes, ideally KANTHAL APM. Available in standard dimensions from 68 to 170 mm diameter *2.6 - 6.6 in.*



Tubes

KANTHAL APM and SANDVIK 253/353 MA extruded radiant tubes for gas- or electrically heated furnaces. Complete assemblies with inner tubes (gas) or suitable electric heating elements. Standard dimensions from 26 to 260 mm outer diameter *1.02- 10.2 in.*

ECOTHAL®

Ecothal is the world's cleanest recuperative radiant heater. With electronically-controlled gas/air supply and double catalytic converters, nitrogen oxide emissions can be reduced by around 75 %.

APM tube and Tubothal.

APM tubes.



Ecothal

*Bild nr 539 Saknas
original*

Heating Elements

Furnace systems and complete heating elements for semiconductor wafer processing. Furnace rebuilds, upgrades and new replacement furnace systems to provide larger wafer processing capabilities.



Helix heating element.

Silicon Carbide

Heating elements in a broad range for use up to 1650 °C 3000 °F. Manufactured in straight, spiralled, single or multi-shank designs for a variety of heat treatment and melting furnaces. Kanthal SiC is the standard element for production of float-glass.

GLOBAR®
FLOAT

Silicon carbide elements.



Kanthal Machinery

Kanthal Machinery offers a complete range of machines for manufacturing of tubes and metal sheathed tubular elements. Available as either standard or custom built stand-alone machines to complete turnkey factory production lines.



Coiling machine.

Customer Service

Kanthal not only offers a complete range of products to generate or protect against heat, but of equal importance is the technical and commercial service we extend to our customers. Examples of this includes; advice on choice of material, design of elements, trouble-shooting, design and manufacturing of complete heating systems, development of new elements and alloys, installation service and follow-up.

Electron Scanning Microscope.



Visit www.kanthal.com

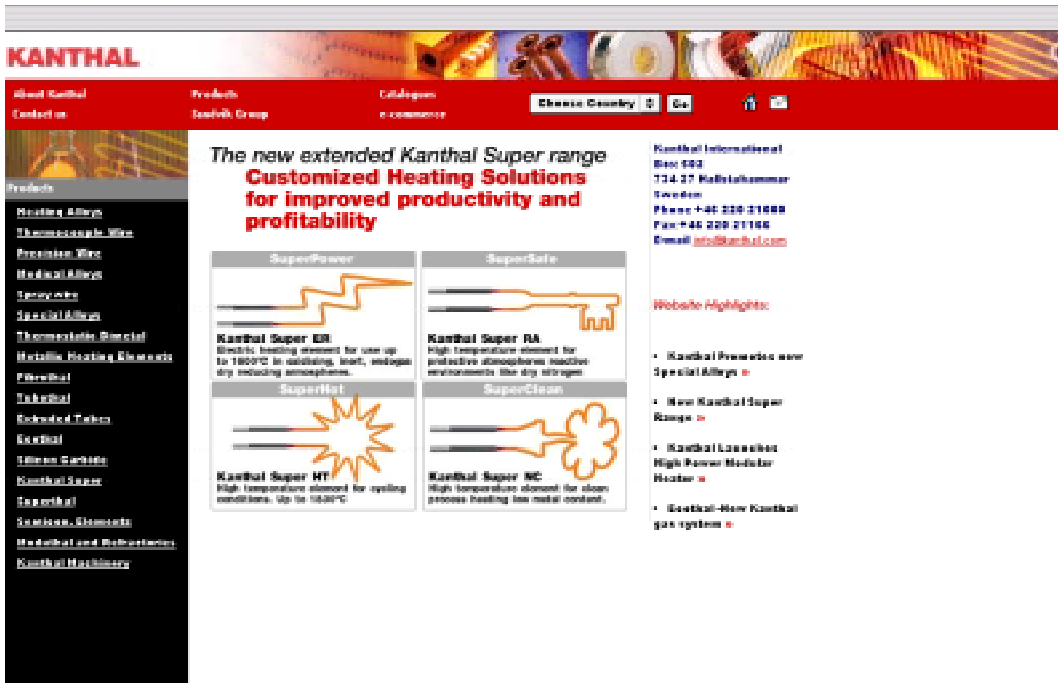

You will always find the latest information about Kanthal and our products on the web. Brochures, handbooks and data-sheets can be downloaded to your computer. You will find address, e-mail, fax- and telephone numbers to all Kanthal subsidiaries and representatives, press releases and other news.

Kanthal is a Sandvik Company.

Sandvik is a high-technology engineering Group with advanced products and a world-leading position within selected niches – tools for metalworking, machinery and tools for rock-excitation, products in stainless steel, special alloys and high temperature materials. World-wide business activities are conducted through 300 companies and representation in 130 countries.

