

4 channel Flow Monitor

# Operation Manual



For Air

PF2A 200/201 Series

For Pure Water/Chemical Fluid

PF2D 200/201 Series

For Water

PF2W 200/201 Series



## SMC Corporation

URL <http://www.smcworld.com>

Thank you for purchasing the SMC PF2□20□ Series 4 Channel Flow Monitor. Please read this manual carefully before operating the Flow Monitor and understand the Flow Monitor, its capabilities and limitations.

Please keep this manual handy for future reference.

## OPERATOR

- This operation manual has been written for those who have knowledge of machinery and apparatus that use pneumatic equipment and have full knowledge of assembly, operation and maintenance of such equipment.
- Please read this operation manual carefully and understand it before assembling, operating or providing maintenance service to the Flow Monitor.

### Phone

AUSTRIA / (43) 2262-62 280	ITALY / (39) 02-92711
BELGIUM / (32) 3-355 1464	NETHERLANDS / (31) 20-531 8888
CZECH REP. / (420) 5-414 24611	NORWAY / (47) 67 12 90 20
DENMARK / (45) 70 25 29 00	POLAND / (48) 22-548 50 85
FINLAND / (358) 9-859 580	PORTUGAL / (351) 2 610 89 22
FRANCE / (33) 1-64 76 1000	SPAIN / (34) 945-18 4100
GERMANY / (49) 6103 4020	SWEDEN / (46) 8-603 0700
GREECE / (30) 1- 342 6076	SWITZERLAND / (41) 52-396 3131
HUNGARY / (36) 1-371 1343	TURKEY / (90) 212 221 1512
IRELAND / (353) 1-403 9000	UNITED KINGDOM / (44) 1908-56 3888



To facilitate recycling, this manual is printed using biodegradable soy ink, which can easily be de-inked.



This manual is printed in the "non-water system", which does not output toxic liquid waste.

# CONTENTS

SAFETY .....	2
Model Indication Method .....	5
Name and Functions of Individual Parts .....	6
Installation .....	8
Example of Internal Circuit and Wiring .....	11
Setting .....	13
Initialize .....	14
Display Function of Integrated Flow Rate Value ..	17
Instantaneous Flow Rate Setting Mode .....	18
Integrated Flow Rate Setting Mode .....	19
Output Selection .....	20
Special Setting .....	23
Other Functions .....	24
Appended Table .....	27
Specification .....	28
Outline with Dimensions .....	34

# SAFETY

The Flow Monitor and this manual contain essential information for the protection of users and others from possible injury and property damage and to ensure correct handling. Please check that you fully understand the definition of the following messages (signs) before going on to read the text, and always follow the instructions. Please read the operation manuals of related apparatus and understand it before operating the Flow Monitor.

## IMPORTANT MESSAGES

Read this manual and follow its instructions. Signal words such as WARNING and NOTE will be followed by important safety information that must be carefully reviewed.

### **⚠WARNING**

Indicates a potentially hazardous situation that could result in death or serious injury if you do not follow instructions.

### **NOTE**

Gives you helpful information.

## **⚠WARNING**

**Do not disassemble, remodel (including change of printed circuit board) or repair.**

An injury or failure can result.

**Do not operate beyond specification range.**

Fire, malfunction or the Flow Monitor damage can result. Please use it after confirming the specification.

**Do not operate in atmosphere of an inflammable, an explosive and corrosive gas.**

Fire, an explosion and corrosion can result. This flow monitor is not an explosion-proof type.

**Prepare the double interlock by another system (Mechanical interlock etc.) and check operating normally, when using this flow monitor for an interlock circuit.**

An accident by a malfunction may potentially result.

**These instructions must be followed while in maintenance ; Turn off the power supply, stop the supplied air, exhaust the residual pressure and verify the release of air before performing maintenance.**

Otherwise it can cause injury.

**NOTE**

Follow the instructions given below when handling Flow Monitor. Otherwise, the Flow Monitor may be damaged or may fail, thereby resulting in malfunction.

- Do not drop it, bring it into collision with other objects or apply excessive shock (980m/s<sup>2</sup> or more).
- Do not pull the lead wire with force or lift the Flow Monitor by holding the lead wire. Pulling strength is as follows.  
Power and output lead wire : less than 50N  
Lead wire with connector for sensor : less than 25N
- Do not use in place which oil or chemical splashes.
- Perform wiring and cable correctly.
- Do not perform wire or cable while power is on.
- Do not use wire or cable with power cable or high-voltage cable in the same route.
- Connect Terminal FG to the ground when using a switching regulator obtained on the commercial market.
- Turn on the power supply when flow is zero.
- Do not insert and pull flow sensor (connector) with the power turned on.
- Do not press the buttons with a sharply pointed tool.
- Start measurement three seconds after turning the power on. Measurement output will be off for the first three seconds after turning the power on.
- 10 minutes after switched on is an interval time. Indications are possibly to be changed a little.

**Model Indication Method**

PF2□20□-□□□

**Option 2****No Symbol** : None**4C** : Connector for Sensor Lead Wire  
(4pcs)**Option 1****No Symbol** : None**A** : Panel Mount Adapter**B** : Panel Mount Adapter

+ Front Face Protective Cover

**Unit Specification****No Symbol** : Unit selection function provided  
(NOTE 1)**M** : SI units fixed (NOTE 2)**Output Specification****0** : NPN open collector 4 outputs**1** : PNP open collector 4 outputs**Applicable Sensor Specification****A** : For air**D** : For pure water / chemical**W** : For water

NOTE 1 : The new Measurement Law prohibits use in Japan of the Flow Monitor with a unit selection function.

NOTE 2 : Fixed unit for instantaneous flow rate is : ℓ/min  
for integrated flow rate is : ℓ

# Name and Functions of Individual Parts

## Main Unit

Switch Output Lamp : Lit when OUT1 (CH1 to CH4) is ON.

Flow Rate Unit Display for Air : Lit CH1 to CH4 when Normal (Only for PF2A20□ for Air condition (nor) is selected.

LCD Display : Displays the current status of flow, setting mode, (Orange) selected indication unit and error code.

△ Button : Selects a mode and increases a set ON/OFF value.

▽ Button : Selects a mode and decreases a set ON/OFF value.

SET Button : Changes the mode and sets a set value.

Unit Display : Lit ON the indicator of selected unit. For the Flow (Orange) Monitor without unit selection function, the unit is fixed to SI (ℓ/min or ℓ).

Unit label : Attach the unit label (CFM, ft<sup>3</sup>, gal(US)/min, gal(US)) with a unit selection function.

Channel Indicator : Indicate the channel (1 to 4) that is selected at (Red) that time.

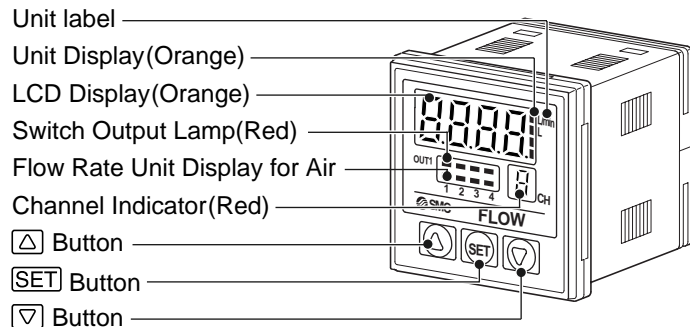

## Accessories

Power and Output Lead Wire with Connector (2m) : **ZS-26-A**

## Options

Connector for Sensor Lead Wire (1pc) : **ZS-28-CA**

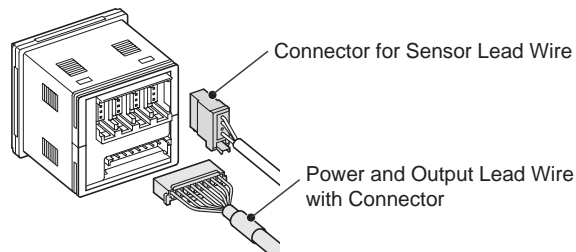

Panel Mount Adapter with set screws M3 × 8L (2pcs) and waterproof seal : **ZS-26-B**

Panel Mount Adapter + Front Face Protective Cover with set screws M3 × 8L (2pcs) and waterproof seal

Front Face Protective Cover : **ZS-26-01**

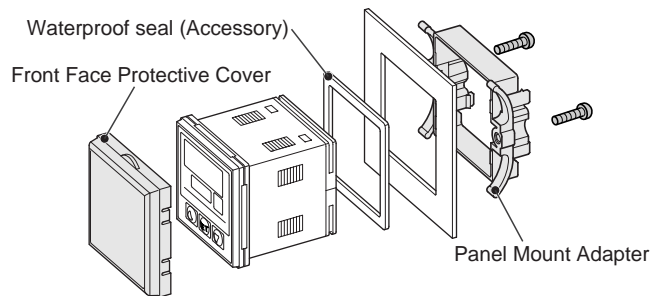

# Installation

## Mounting by Panel mount adapter

- Fix the panel mount adapter to the Flow Monitor with the set screws M3 × 8L (2pcs) as attached.

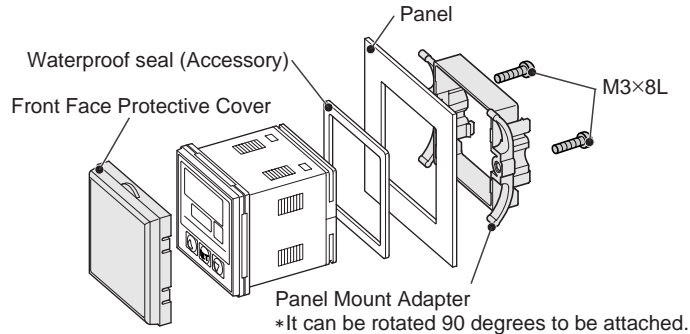

- \*Front panel of this Flow Monitor meets IP65. However, if the panel mount adapter is hold enough with screw and the instrument is not seated correctly, water might enter. Screw shall be tightened 1/4 to 1/2 turns more after touched correctly.

## Panel Cut Dimensions

Panel thickness: 0.5 to 8mm

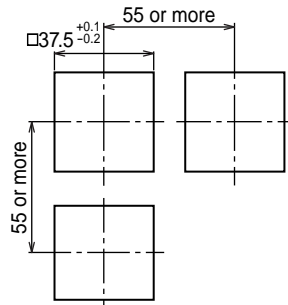

## Connection

- Make connection after turning the power off.
- Install the lead wire separately from the route for power cable or high-voltage cable.  
Otherwise, malfunction may potentially result due to noise.
- Be sure to ground Terminal FG when using a switching regulator obtained on the commercial market.

## Notice when removing the panel mount adapter

- The Flow Monitor with panel mount adapter can be removed from facility after removing two screws as shown in a figure, by making insert the suitable thin card for the hook of both the sides, pull a panel mount adapter to the front, and remove it.  
If panel mount adapter is drawn forward with hook caught, the adapter and the Flow Monitor may be damaged.

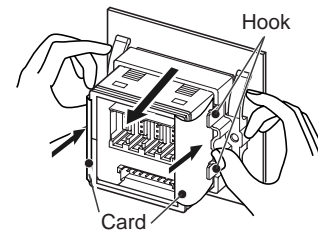

## Attaching the connector to the lead wire

- Sensor wire is stripped as shown in the right figure. (Refer to the appended table on page 27.)

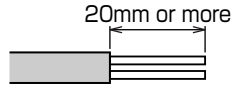

- The core of the corresponding color shown in the following table is put into the pin of the number stamped on the connector for sensor connection to the back.

Pin No.	Wire Color
1	Brown (DC+)
2	NC
3	Blue (DC-)
4	White (IN:1 to 5VDC)

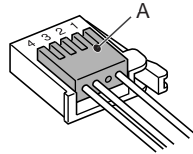

- It checks that the above-mentioned preparation work has been performed correctly, and A part shown in right figure is pushed by hand and makes temporary connection.

- A part center is straightly pushed in by tools, such as pliers.

- Re-use cannot be performed once it connects the connector for sensor connection completely.

- When you fail in the connection mistake of a core and a pin, or the plug of wire, please use the new connector for sensor connection.

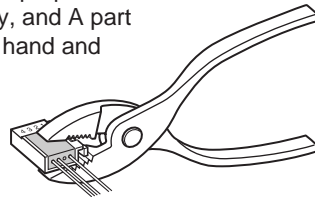

## Connector

### Connector Connecting/Disconnecting

- When connecting the connector, insert it straight onto the pin and lock the connector into the square groove in the housing until connector clicks.

- When disconnecting the connector, push down the lever by thumb to disengage the lever claw from the square groove. Then pull out the connector straight.

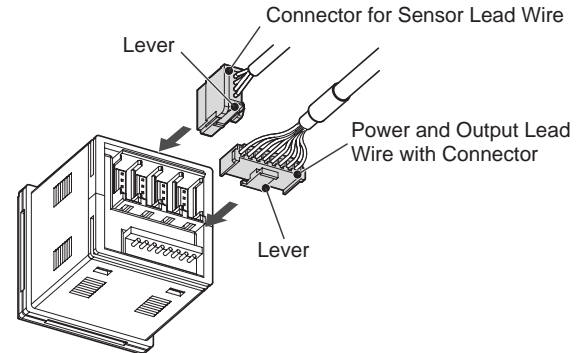

### Pin No. of the connector for power and output lead wire

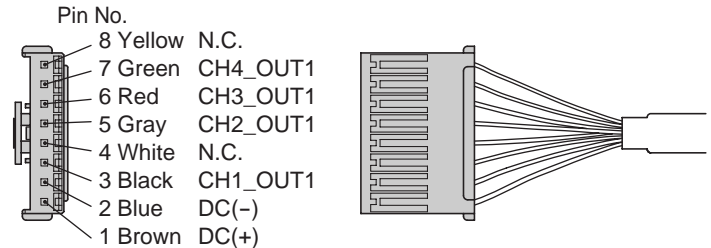

## Example of Internal Circuit and Wiring (continue)

### Output Specification

When the lead wire with SMC Power and Output Lead Wire (type ZS-26-A) is used, the colors of wire (Brown, Blue, Black, White, Gray, Red, Green, Yellow) will apply as shown on circuit diagram.

PF2□200 : NPN Open Collector 4 outputs  
Max. 30V, 80mA Residual voltage 1V or less

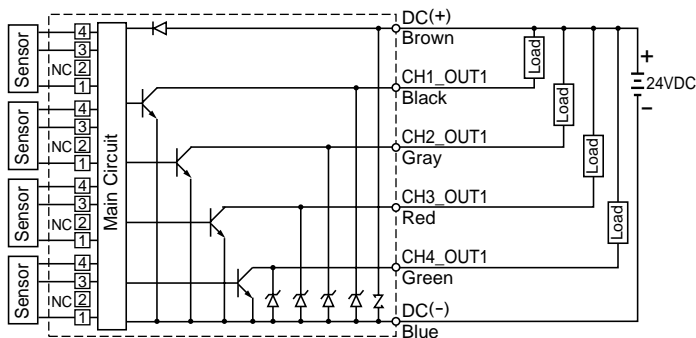

PF2□201 : PNP Open Collector 4 outputs  
Max. 80mA Residual voltage 1V or less

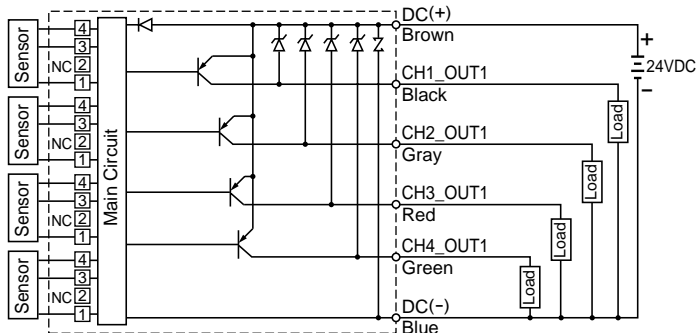

## Setting

### Setting Procedures

#### Measurement Mode

#### Initialize

Flow rate range, Display mode, Display unit\*1, Output method, Output mode and Flow rate display unit\*2 setting.

#### Flow Setting

Input a set value for flow to perform switch output.

#### Special Setting

Set copy setting.

#### Measurement Mode

Detects flow, displays values and performs switching. Other functions such as display instantaneous flow rate or display integrated flow rate can also be set if necessary.

\*1 In case [-M] is not assigned to unit specification in model indication.

\*2 Only for PF2A20□ for Air.



# Initialize

Select the setting channel by pressing the  $\Delta$  button and keep pressing the  $\text{SET}$  button longer than 2 seconds. When indication on display is changed from [F\_1], [F\_2] or [F\_3] to one of the followings, press  $\text{SET}$  button.

## 1. Flow Rate Range Setting

Select the flow rate range suitable for the sensor part to connect.



Press the  $\Delta$  button and select the flow rate range for the sensor part to connect, and press the  $\text{SET}$  button to set.

Display part	LED Display	Sensor part ( Flow rate range )
PF2A 20□	10L	PF2A 510-□-1 (1~10 l/min)
	50L	PF2A 550-□-1 (5~50 l/min)
	11L	PF2A 511-□-1 (10~100 l/min)
	21L	PF2A 521-□-1 (20~200 l/min)
PF2D20□	51L	PF2A 551-□-1 (50~500 l/min)
	04d	PF2D 504-□-1 (0.4~4 l/min)
	20d	PF2D 520-□-1 (1.8~20 l/min)
PF2W20□	40d	PF2D 540-□-1 (4~40 l/min)
	04L	PF2W 504-□-1 (0.5~4 l/min)
		PF2W 504T-□-1 (0.5~4 l/min)
	20L	PF2W 520-□-1 (2~16 l/min)
		PF2W 520T-□-1 (2~16 l/min)
	40L	PF2W 540-□-1 (5~40 l/min)
		PF2W 540T-□-1 (5~40 l/min)
	11L	PF2W 511-□-1 (10~100 l/min)

## 2. Display Mode Setting

Select whether to display instantaneous flow rate or integrated flow rate.

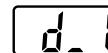

To change the Display mode, press the  $\Delta$  button and select the desired flow rate to display. Then press the  $\text{SET}$  button.

[d\_1] and [d\_2] respectively indicate the instantaneous flow rate and integrated flow rate.

## 3. Selecting Display Unit

In case [-M] is not assigned to unit specification in model indication

Two units each in instantaneous flow rate or integrated flow rate can be selected freely. Pressing the  $\Delta$  button in unit setting will change to a unit and a set value will be converted automatically.

Press the  $\text{SET}$  button to set and to move to setting the output method.

Display part	LED display	Instantaneous flow rate	Integrated flow rate
PF2A 20□	U_1	l/min	l
	U_2	CFM × 10 <sup>-2</sup> , CFM × 10 <sup>-1</sup> *1	ft <sup>3</sup> × 10 <sup>-2</sup> , ft <sup>3</sup> × 10 <sup>-1</sup> *1
PF2D20□	U_1	l/min	l
	U_2	gal(US)/min	gal(US)
PF2W20□	U_1	l/min	l
	U_2	gal(US)/min	gal(US)

\*1. CFM × 10<sup>-2</sup>, ft<sup>3</sup> × 10<sup>-2</sup> for PF2A5□0-□-1 and CFM × 10<sup>-1</sup>, ft<sup>3</sup> × 10<sup>-1</sup> for PF2A5□1-□-1 is selected respectively.

#### 4. Output Method Setting

Three output methods are available, namely, instantaneous switch, integrated switch and integrated pulse. The method for output to OUT1 is set as follows.



- Press the button and select the instantaneous switch, integrated switch or integrated pulse.

[o10] [o11] and [o12] respectively indicate the instantaneous switch, integrated switch and integrated pulse.

- The setting is fixed by press of button, and the display is changed to show output mode setting.

#### 5. Output Mode Setting

Two output modes are available, namely, the Reverse Output mode and Non-Reverse Output mode. An output mode for OUT1 is set.

- Press the button and select the Reverse Output mode or Non-Reverse Output mode.

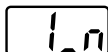

[1\_n] and [1\_P] respectively indicate the Reverse Output mode and Non-Reverse Output mode.

- The setting is fixed by press of button, and in PF2A20□, the display is change to show flow rate display unit selection. In PF2D20□ and PF2W20□, the display is returned to measurement mode.

#### 6. Selecting Flow Rate Display Unit

(Only for PF2A 20□ for Air)

Two units in normal condition or standard condition (ANR) can be selected.

Normal condition: 0°C/ 101.3kPa

Standard condition: 20°C/ 101.3kPa/ 65%RH

- Press the button and select the display unit. [nor] means Normal condition and [Anr] means Standard condition.
- When select normal condition, Flow Rate Unit Display for Air lights up.
- The setting is fixed by press of button, and the display is returned to measurement mode.



### Display Function of Integrated Flow Rate Value

- If integrated flow rate display is selected at initial setting, the following operation can start, stop and clear the integration. To start integration, first button and then button are pressed and they are held pressed until [ - ] begins flashing.
- Lower three digits of an integrated value are always displayed. To check first 3 digits, first button and then button are pressed and they are held pressed.
- Pressing the button enables to display an instantaneous flow rate even during integration.
- To stop integration, press the button first, then the button, to press both buttons simultaneously. The display will keep the present integrated value. To further continue integration from the saved value, repress the button first, then the button, to press both buttons simultaneously.
- To clear integration, stop integration at first, and press both button and button in order for 4 seconds or more.

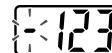

## Instantaneous Flow Rate Setting Mode

Set an actuation value of the instantaneous-value switch in case the instantaneous switch is selected in initialization.

The output method is also set in accordance with the value set manually. Set the output method while referring to the output method described another page.

1. Keep pressing the **[SET]** button and remove the finger off when [F\_1] is displayed.

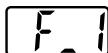

2. Repress the **[SET]** button to set for input of a set value in [n\_1] ([P\_1] in the Non-Reverse Output mode) for OUT1.

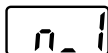

In case the Reverse Output mode is selected in initialization, [n\_1] and the set value will be displayed alternately.

(In case the Non-Reverse Output mode is selected in initialization, [P\_1] and the set value will be displayed alternately.)

3. Press the **[Δ]** button or **[▽]** button to select a desired set value.

Press the **[Δ]** button to increase the set value or the **[▽]** button to decrease the set value.

4. Press the **[SET]** button to set the set value and to move to the setting mode for [n\_2] ([P\_2] in the Non-Reverse Output mode).

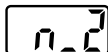

In case the Reverse Output mode is selected in initialization, [n\_2] and the set value will be displayed alternately.

(In case the Non-Reverse Output mode is selected in initialization, [P\_2] and the set value will be displayed alternately.)

5. Press the **[Δ]** button or **[▽]** button to select a desired set value. Press the **[Δ]** button to increase the set value or the **[▽]** button to decrease the set value.
6. Press the **[SET]** button to set the set value and the display is returned to measurement mode.

## Integrated Flow Rate Setting Mode

Set an actuation value of the integrated-value switch in case the integrated switch is selected in initialization.

The output method is also set in accordance with the value set manually. Set the output method while referring to the output method described another page.

1. Keep pressing the **[SET]** button and remove the finger off when [F\_2] is displayed.

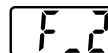

2. Repress the **[SET]** button to make it in setting value input mode of three subordinate digits of integrated flow of [1nL] ([1PL] in the Non-Reverse Output mode) for OUT1.



In case the Reverse Output mode is selected in initialization, [1nL] and the set value will be displayed alternately.

(In case the Non-Reverse Output mode is selected in initialization, [1PL] and the set value will be displayed alternately.)

3. Press the **[Δ]** button or **[▽]** button to select a desired set value.

Press the **[Δ]** button to increase the set value or the **[▽]** button to decrease the set value.

4. Press the **[SET]** button to set the upper three digits of integrated flow rate value, and to move to the setting mode for [1nH] ([1PH] in the Non-Reverse Output mode).

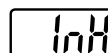

In case the Reverse Output mode is selected in initialization, [1nH] and the set value will be displayed alternately.

(In case the Non-Reverse Output mode is selected in initialization, [1PH] and the set value will be displayed alternately.)

5. Press the **[Δ]** button or **[▽]** button to select a desired set value.

Press the **[Δ]** button to increase the set value or the **[▽]** button to decrease the set value.

6. Press the **[SET]** button to set the set value and the display is returned to measurement mode.

# Output Selection

## Instantaneous Switch Output Method

Four output methods can be selected by selecting an output mode and by combining large and small set values of OUT1. One of these four output methods can be selected.

- 1 digit flow rate conversion will be a minimum set unit. See the specification for the minimum set unit.
- If hysteresis is reduced in hysteresis mode, switch output may start chattering when flow rate changes around set value.
- In window comparator mode, hysteresis is 3 digits fixed. When it is used at window comparator mode, put 7 digits or more intervals between  $[n\_1]$  and  $[n\_2]$  or  $[P\_1]$  and  $[P\_2]$ .

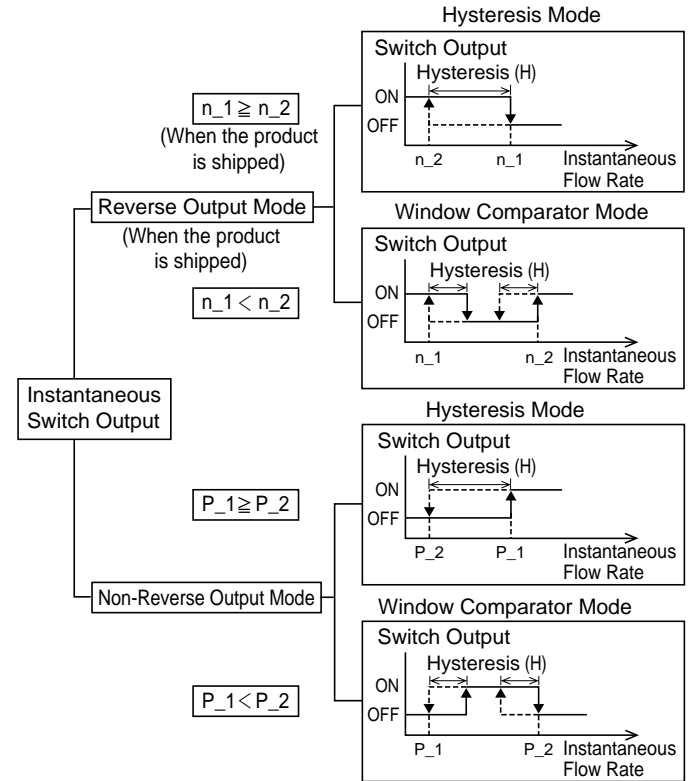

### Integrated Switch Output

- Two output methods can be selected by selecting an output mode. One of these two output methods can be selected.

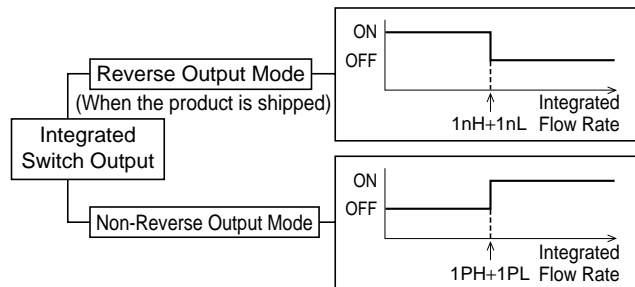

### Integrated Pulse Output

- Pulse output for integrated flow rate measurement. Integrated pulse output in NPN or PNP open collector. (Same specification as that of switch output)

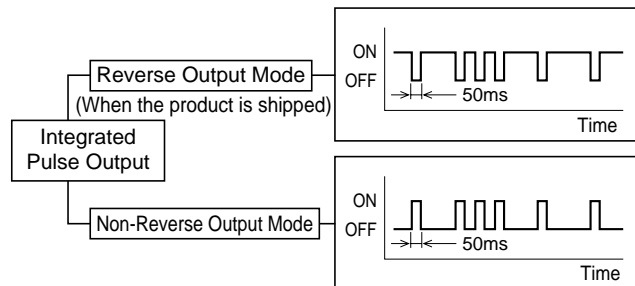

### Copy function

1) Flow rate range, Display mode, Display unit (Only for in case [-M] is not assigned to unit specification in model indication), Output method, Output mode, Flow rate display unit (Only for PF2A20□ for Air), Set value for a flow rate are copied.

- [SET] button is pressed, and released when [F\_1] or [F\_2] is indicated. Then [↔] button is pressed to change the indication to [F\_3].

\*1.If output method is set to integrated pulse at initial setting, [F\_3] is indicated by press of [SET] button.

\*2.If copy mode setting is not required, [SET] button is pressed when [F\_3] is indicated.

- If [△] button is pressed when [F\_3] is indicated, the display is changed to show [CPy] and the copied channel starts flashing. Select copied channel by pressing of [△] button.



- Press the [SET] button so that the channel display of a copied material changes from flashing to lighting.
- [CPy] and the channel to be pasted will flicker alternately. Next, select channel to be pasted by [△] button.

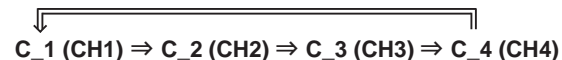

- Press the [SET] button, and return to [F\_3] display.
- [△] button is pressed again and the same operation is repeated to copy other channels.
- After setting is finished, [SET] button is pressed when [F\_3] is indicated.

## Other Functions

### Peak and Bottom Hold Display Function

When instantaneous flow rate indication mode is selected at initial setting, it is possible to hold max. or minimum value following the operation stated below.

- When instantaneous flow rate indication is shown, first  $\square$  button and then  $\square$  button are pressed and they are held pressed for 2 seconds or more.
- Select Peak/Bottom mode by pressing  $\square$  button.

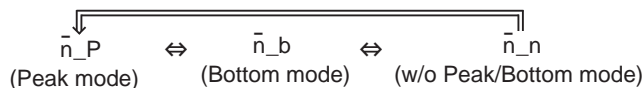
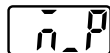

- When  $\square$  button is pressed when  $[\bar{n}_P]$  (Peak mode) is selected,  $[-]$  lights up and peak value is indicated.
- When  $\square$  button is pressed when  $[\bar{n}_b]$  (Bottom mode) is selected,  $[-]$  lights up and peak value is indicated.
- When  $\square$  button is pressed when  $[\bar{n}_n]$  (w/o Peak/Bottom mode) is selected, the display is returned to measurement mode.
- To reset holding, select  $[\bar{n}_n]$ .



### Key Lock Function

This function prevents errors such as changing a set value by mistake. Set [Loc] (lock mode) in order not to accept button operation.

#### Lock

- Keep pressing the  $\square$  button longer than 4 seconds. Remove the finger off the button when [unL] is displayed.
- Press the  $\square$  button to set the display to [Loc].
- Pushing  $\square$  button makes it return to measurement mode.

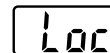
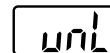

\* The operation of channel selects and channel scans is not locked in the state of Key Lock.

#### Unlock

- Keep pressing the  $\square$  button longer than 4 seconds. Remove the finger off the button when [Loc] is displayed.
- Press the  $\square$  button to set the display to [unL].
- Pushing  $\square$  button makes it return to measurement mode.

### Channel selects Function

- Per one push  $\square$  button, selection can be done, like [1 → 2 → 3 → 4 → 1...]. Display shows flow value, which is measured at the channel selected.

### Channel scans Function

- Keep pressing  $\square$  button for 2 seconds or more. It changes indicating the channel indicated ever two seconds and measuring flow coping with it.
- To reset this function, press  $\square$  button again for 2 seconds or more.

## Error Display Function

This function displays error location and nature when a problem or an error occurs.

Error name	Error display	Contents	Disposition
Over current error	Er 1	Over 80mA load current of switch output flows.	Off the power, remove the output cause that brought over current, and re-input power.
	Er 0	Internal data error causes this display.	Needs our investigation.
System error	Er 7	Internal date error causes this display.	
	Er 10	Internal data error causes this display.	
	Er 5	Internal date error causes this display.	Off the power, and re-input power.
	Er 6	Internal date error causes this display.	

•If the above remedy can't recover the operation, the error needs to be investigated at SMC.

## Appended Table

The connector, which suits the lead wire used, is shown in following Tables.

### Lead Wire Table

SMC Product No. (1pc)	Color of cover	Applicable gauge of cable ( $\phi$ )	AMP Product No.
ZS-28-CA-1	Orange	0.6 to 0.9	3-1473562-4
ZS-28-CA-2	Red	0.9 to 1.0	1-1473562-4
ZS-28-CA-3	Yellow	1.0 to 1.15	1473562-4
ZS-28-CA-4	Blue	1.15 to 1.35	2-1473562-4
ZS-28-CA-5	Green	1.35 to 1.60	4-1473562-4

SMC Product No. (1pc)	Color of cover	Applicable gauge of cable ( $\phi$ )	Sumitomo 3M Product No.
ZS-28-C	Red	0.8 to 1.0	37104-3101-000FL
ZS-28-C-1	Yellow	1.0 to 1.2	37104-3122-000FL

SMC Product No. (1pc)	Color of cover	Applicable gauge of cable ( $\phi$ )	OMRON Product No.
—	Transparency	1.5 or less	XN2A-1430 *

\* If cable drawing-out intensity becomes more than 12N, a cable may separate from it.

# Specification

		PF2A200/201			
Applicable flow sensor	PF2A510-□-1	PF2A550-□-1	PF2A511-□-1	PF2A521-□-1	PF2A551-□-1
Flow rate indication range *1	0.5 to 10.5 ℓ/min	2.5 to 52.5 ℓ/min	5 to 105 ℓ/min	10 to 210 ℓ/min	25 to 525 ℓ/min
Set flow rate range *1	0.5 to 10.5 ℓ/min	2.5 to 52.5 ℓ/min	5 to 105 ℓ/min	10 to 210 ℓ/min	25 to 525 ℓ/min
Minimum set unit *1	0.1 ℓ/min	0.5 ℓ/min	1 ℓ/min	2 ℓ/min	5 ℓ/min
Flow rate conversion value (Pulse width:50ms) *1	0.1 ℓ/pulse	0.5 ℓ/pulse	1 ℓ/pulse	2 ℓ/pulse	5 ℓ/pulse
Unit *1,2	Instantaneous flow rate	ℓ/min, CFM×10 <sup>-2</sup>		ℓ/min, CFM×10 <sup>-1</sup>	
	Integrated flow rate	ℓ, ft <sup>3</sup> ×10 <sup>-2</sup>		ℓ, ft <sup>3</sup> ×10 <sup>-1</sup>	
Integrated flow rate range *1	0 to 999999 ℓ 0 to 999999ft <sup>3</sup> ×10 <sup>-2</sup>		0 to 999999 ℓ, 0 to 999999ft <sup>3</sup> ×10 <sup>-1</sup>		
Power supply voltage	24VDC, ripple (p-p) ±10% or less (Protected against inverse connection)				
Current consumption	55mA or less (Except for consumed current of sensor part)				
Power supply voltage for sensor	Same as Power supply voltage				
Power supply current for sensor *3	Max. 110mA (Max. total consumed current is 440mA or less for inputting 4 sensors.)				
Sensor input	1 to 5VDC (Input impedance : Approx. 800kΩ)				
	Number of input	4 inputs			
	Input protection	With over voltage protection			
Output specification *4	Switch output	NPN open collector (PF2A200)	Maximum load current : 80mA Internal voltage drop : 1V or less (@load current 80mA) Maximum input voltage : 30V		
		PNP open collector (PF2A201)	Maximum load current : 80mA Internal voltage drop : 1V or less (@load current 80mA)		
	Integrated pulse output	NPN or PNP open collector output (same specification as that of switch output)			
	Number of output	4 outputs (1 output per each sensor input)			
	Output protection	Short circuit protection is provided			

		PF2A200/201
Hysteresis	Hysteresis Mode: Variable (Settable starting 0), Window Comparator Mode: fixed (3digits)	
Response time *5	1s or less	
Linearity *5	±5% F.S. or less	
Repeatability *5	±3% F.S. or less	
Temperature characteristic	±2% F.S. or less (0 to 50°C, 25°C)	
LCD display	Display for measured value : 4 digits 7-segment (Orange) Display for channel : 1 digit 7-segment (Red)	
Operation display	Output illuminates at ON (Red)	
Environment	Enclosure	Front part : IP65 (@ Mounted panel), Others : IP40
	Operating temp. range	Operation: 0 to 50°C, Storage : -10 to 60°C (No condensation, no freezing)
	Operating humidity range	Operation/Storage : 35 to 85% RH (No condensation)
	Vibration proof	10 to 500Hz smaller one 1.5mm or 98m/s <sup>2</sup> double amplitude, each in directions of X, Y and Z for 2 hours
	Impact proof	980m/s <sup>2</sup> , 3 times each in directions of X, Y and Z respectively
	Resistance to noise	500Vp-p pulse width 1μs, rise 1ns
Connection	Power supply and output connection : 8P connector, Sensor connection : e-con	
Material	Body : PBT, Display : PET, Rubber cover for the back : CR	
Mass (Weight)	60g (Accessories not included)	

\*1 Without a unit selection function, fixed to SI units (ℓ/min or ℓ).

\*2 Two units in normal condition (0°C/101.3kPa) or standard condition (ANR : 20°C/101.3kPa/65%RH) can be selected.

\*3 Over current on Vcc side and 0V side of sensor input connector results in breakage of internal parts of this Flow Monitor.

\*4 Select whether to switch output or pulse output of integrated flow rate by the initialization.

\*5 It is the system accuracy when combined with a compatible flow sensor.

\*6 This product conforms to the CE standard.



## Specification (continue)

		PF2D200/201		
Applicable flow sensor		PF2D504-□-1	PF2D520-□-1	PF2D540-□-1
Flow rate indication range *1		0.25 to 4.50 ℓ/min	1.3 to 21.0 ℓ/min	2.5 to 45.0 ℓ/min
Set flow rate range *1		0.25 to 4.50 ℓ/min	1.3 to 21.0 ℓ/min	2.5 to 45.0 ℓ/min
Minimum set unit *1		0.05 ℓ/min	0.1 ℓ/min	0.5 ℓ/min
Flow rate conversion value (Pulse width:50ms) *1		0.05 ℓ /pulse	0.1 ℓ /pulse	0.5 ℓ /pulse
Unit *1	Instantaneous flow rate	ℓ/min, gal(US) /min		
	Integrated flow rate	ℓ, gal(US)		
Integrated flow rate range *1		0 to 999999 ℓ, 0 to 999999 gal(US)		
Power supply voltage		24VDC, ripple (p-p) ±10% or less (Protected against inverse connection)		
Current consumption		55mA or less (Except for consumed current of sensor part)		
Power supply voltage for sensor		Same as Power supply voltage		
Power supply current for sensor *2		Max. 110mA (Max. total consumed current is 440mA or less for inputting 4 sensors.)		
Sensor input		1 to 5VDC (Input impedance : Approx. 800kΩ)		
	Number of input	4 inputs		
	Input protection	With over voltage protection		
Output specification *3	Switch output	NPN open collector (PF2D200)	Maximum load current : 80mA Internal voltage drop : 1V or less (@load current 80mA) Maximum input voltage : 30V	
		PNP open collector (PF2D201)	Maximum load current : 80mA Internal voltage drop : 1V or less (@load current 80mA)	
	Integrated pulse output	NPN or PNP open collector output (same specification as that of switch output)		
	Number of output	4 outputs (1 output per each sensor input)		
	Output protection	Short circuit protection is provided		

		PF2D200/201	
Hysteresis		Hysteresis Mode: Variable (Settable starting 0), Window Comparator Mode: fixed (3digits)	
Response time *4		1s or less	
Linearity *4		±5% F.S. or less	
Repeatability *4		±3% F.S. or less	
Temperature characteristic		±2% F.S. or less (0 to 50°C, 25°C)	
LCD display		Display for measured value : 4 digits 7-segment (Orange) Display for channel : 1 digit 7-segment (Red)	
Operation display		Output illuminates at ON (Red)	
Environment	Enclosure	Front part : IP65 (@ Mounted panel), Others : IP40	
	Operating temp. range	Operation: 0 to 50°C, Storage : -10 to 60°C (No condensation, no freezing)	
	Operating humidity range	Operation/Storage : 35 to 85% RH (No condensation)	
	Vibration proof	10 to 500Hz smaller one 1.5mm or 98m/s <sup>2</sup> double amplitude, each in directions of X, Y and Z for 2 hours	
	Impact proof	980m/s <sup>2</sup> , 3 times each in directions of X, Y and Z respectively	
	Resistance to noise	500Vp-p pulse width 1μs, rise 1ns	
Connection		Power supply and output connection : 8P connector, Sensor connection : e-con	
Material		Body : PBT, Display : PET, Rubber cover for the back : CR	
Mass (Weight)		60g (Accessories not included)	

\*1 Without a unit selection function, fixed to SI units (ℓ/min or ℓ).

\*2 Over current on Vcc side and 0V side of sensor input connector results in breakage of internal parts of this Flow Monitor.

\*3 Select whether to switch output or pulse output of integrated flow rate by the initialization.

\*4 It is the system accuracy when combined with a compatible flow sensor.

\*5 This product conforms to the CE standard.

## Specification (continue)

		PF2W200/201			
Applicable flow sensor		PF2W504-□-1 PF2W504T-□-1	PF2W520-□-1 PF2W520T-□-1	PF2W540-□-1 PF2W540T-□-1	PF2W511-□-1
Flow rate indication range *1		0.35 to 4.50 ℓ/min	1.7 to 17.0 ℓ/min	3.5 to 45.0 ℓ/min	7 to 110 ℓ/min
Set flow rate range *1		0.35 to 4.50 ℓ/min	1.7 to 17.0 ℓ/min	3.5 to 45.0 ℓ/min	7 to 110 ℓ/min
Minimum set unit *1		0.05 ℓ/min	0.1 ℓ/min	0.5 ℓ/min	1 ℓ/min
Flow rate conversion value (Pulse width:50ms) *1		0.05 ℓ/pulse	0.1 ℓ/pulse	0.5 ℓ/pulse	1 ℓ/pulse
Unit *1	Instantaneous flow rate	ℓ /min, gal(US) /min			
	Integrated flow rate	ℓ, gal(US) /min			
Integrated flow rate range *1		0 to 999999 ℓ, 0 to 999999 gal(US)			
Power supply voltage		24VDC, ripple (p-p) ±10% or less (Protected against inverse connection)			
Current consumption		55mA or less (Except for consumed current of sensor part)			
Power supply voltage for sensor		Same as Power supply voltage			
Power supply current for sensor *2		Max. 110mA (Max. total consumed current is 440mA or less for inputting 4 sensors.)			
Sensor input		1 to 5VDC (Input impedance : Approx. 800kΩ)			
	Number of input	4 inputs			
	Input protection	With over voltage protection			
Output specification *3	Switch output	NPN open collector (PF2W200)	Maximum load current : 80mA Internal voltage drop : 1V or less (@load current 80mA) Maximum input voltage : 30V		
		PNP open collector (PF2W201)	Maximum load current : 80mA Internal voltage drop : 1V or less (@load current 80mA)		
	Integrated pulse output	NPN or PNP open collector output (same specification as that of switch output)			
	Number of output	4 outputs (1 output per each sensor input)			
Output protection		Short circuit protection is provided			

		PF2W200/201
Hysteresis		Hysteresis Mode: Variable (Settable starting 0), Window Comparator Mode: fixed (3digits)
Response time *4		1s or less
Linearity *4		±5% F.S. or less
Repeatability *4		±3% F.S. or less
Temperature characteristic		±2% F.S. or less (0 to 50°C, 25°C)
LCD display		Display for measured value : 4 digits 7-segment (Orange) Display for channel : 1 digit 7-segment (Red)
Operation display		Output illuminates at ON (Red)
Environment	Enclosure	Front part : IP65 (@ Mounted panel), Others : IP40
	Operating temp. range	Operation: 0 to 50°C, Storage : -10 to 60°C (No condensation, no freezing)
	Operating humidity range	Operation/Storage : 35 to 85% RH (No condensation)
	Vibration proof	10 to 500Hz smaller one 1.5mm or 98m/s <sup>2</sup> double amplitude, each in directions of X, Y and Z for 2 hours
	Impact proof	980m/s <sup>2</sup> , 3 times each in directions of X, Y and Z respectively
Resistance to noise		500Vp-p pulse width 1μs, rise 1ns
Connection		Power supply and output connection : 8P connector, Sensor connection : e-con
Material		Body : PBT, Display : PET, Rubber cover for the back : CR
Mass (Weight)		60g (Accessories not included)

\*1 Without a unit selection function, fixed to SI units (ℓ/min or ℓ).

\*2 Over current on Vcc side and 0V side of sensor input connector results in breakage of internal parts of this Flow Monitor..

\*3 Select whether to switch output or pulse output of integrated flow rate by the initialization.

\*4 It is the system accuracy when combined with a compatible flow sensor.

\*5 This product conforms to the CE standard.

# Outline with Dimensions (in mm)

## Dimensions of Main Unit

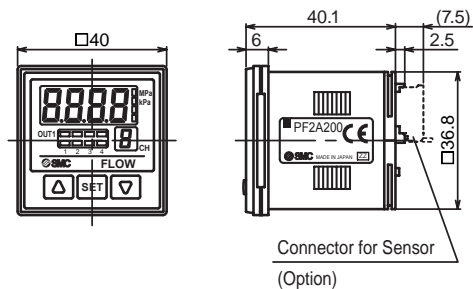

## Front Face protective Cover + Panel Mount Type

