



KONDENZATORI **Ko**

KERAMIČKI KONDENZATORI
VIŠESLOJNI KERAMIČKI KONDENZATORI
POLIESTER - BLOK KONDENZATORI
ELEKTROLITSKI KONDENZATORI
BIPOLARNI KONDENZATORI
TANTAL KONDENZATORI
FILTERSKI KONDENZATORI
KONDENZATORI ZA RSO
TRIMER KONDENZATORI
KONDENZATORI BACK - UP
KONDENZATORI SMD





KONDEZATORI

KO

KERAMIČKI KONDEZATORI KOKE

KERAMIČKI KONDEZATORI 63V

Tehnički podaci

Kapacitet: 0,5 pF - 100 nF
 Napon: 63V
 Temperaturni opseg: -30...+85°C
 Raster: 2,54/5,08 mm

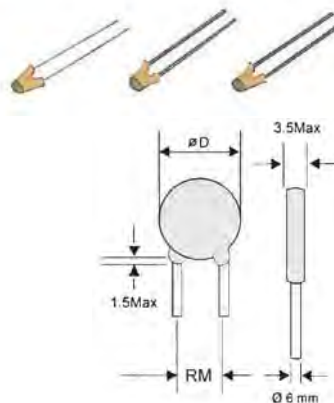

Kapacitet	Cena	Tolerancija %	D mm	Raster RM
0,5pF	0,15	± 5%	5,1	2,54
0,68pF	0,15	± 5%	5,1	2,54
1pF	0,12	± 5%	5,1	2,54
1,1pF	0,12	± 5%	5,1	2,54
1,2pF	0,12	± 5%	5,1	2,54
1,3pF	0,12	± 5%	5,1	2,54
1,5pF	0,12	± 5%	5,1	2,54
1,6pF	0,12	± 5%	5,1	2,54
1,8pF	0,12	± 5%	5,1	2,54
2pF	0,12	± 5%	5,1	2,54
2,2pF	0,12	± 5%	5,1	2,54
2,4pF	0,12	± 5%	5,1	2,54
2,7pF	0,12	± 5 %	5,1	2,54
3pF	0,12	± 5 %	5,1	2,54
3,3pF	0,12	± 5 %	5,1	2,54
3,6pF	0,12	± 5 %	5,1	2,54
3,9pF	0,12	± 5 %	5,1	2,54
4,7pF	0,12	± 5 %	5,1	2,54
5,6pF	0,12	± 5 %	5,1	2,54
6,2pF	0,12	± 5 %	5,1	2,54
6,8pF	0,12	± 5 %	5,1	2,54
7,5pF	0,12	± 5 %	5,1	2,54
8,2pF	0,12	± 5 %	5,1	2,54
9,1pF	0,12	± 5 %	5,1	2,54
10pF	0,12	± 5 %	5,1	2,54
12pF	0,12	± 5 %	5,1	2,54
15pF	0,12	± 5 %	5,1	2,54
18pF	0,12	± 5 %	5,1	2,54
20pF	0,12	± 5 %	5,1	2,54
22pF	0,12	± 5 %	5,1	2,54
27pF	0,12	± 5 %	5,1	2,54
30pF	0,12	± 5 %	5,1	2,54
33pF	0,12	± 5 %	5,1	2,54
39pF	0,12	± 5 %	5,1	2,54
47pF	0,12	± 5 %	5,1	2,54
56pF	0,12	± 5 %	5,1	2,54
68pF	0,12	± 5%	5,1	2,54
82pF	0,12	± 5%	5,1	2,54
100pF	0,12	± 10%	5,1	2,54

Kapacitet	Cena	Tolerancija %	D mm	Raster RM
120pF	0,12	± 10%	5,1	2,54
150pF	0,12	± 10%	5,1	2,54
180pF	0,12	± 10%	5,1	2,54
220pF	0,12	± 10%	5,1	2,54
270pF	0,12	± 10%	5,1	2,54
330pF	0,12	± 10%	5,1	2,54
390pF	0,12	± 10%	5,1	2,54
470pF	0,12	± 10%	5,1	2,54
560pF	0,12	± 10%	5,1	2,54
680pF	0,12	± 10%	5,1	2,54
820pF	0,12	± 10%	5,1	2,54
1nF	0,15	± 20%	5,1	2,54
1,2nF	0,15	± 20 %	5,1	2,54
1,5nF	0,15	± 20 %	5,1	2,54
1,8nF	0,15	± 20 %	5,1	2,54
2,2nF	0,15	± 20 %	5,1	2,54
2,7nF	0,15	± 20 %	5,1	2,54
3,3nF	0,15	± 20 %	5,1	2,54
3,9nF	0,15	± 20 %	5,1	2,54
4,7nF	0,15	± 20 %	6,5	5,08
5,6nF	0,16	± 20 %	6,5	5,08
6,8nF	0,16	± 20 %	6,5	5,08
8,2nF	0,16	± 20 %	6,5	5,08
10nF	0,16	± 20 %	8,1	5,08
15nF	0,16	± 20 %	8,1	5,08
22nF	0,17	± 20 %	8,1	5,08
33nF	0,18	± 20 %	8,1	5,08
47nF	0,19	± 20 %	8,1	5,08
68nF	0,20	± 20 %	8,5	5,08
100nF	0,22	± 20 %	9,5	5,08



KONDENZATORI

KO

KERAMIČKI KONDENZATORI KOKE

KERAMIČKI KONDENZATORI 500V

Tehnički podaci

Kapacitet: 10 pF - 100 nF
 Napon: 500V
 Temperaturni opseg: -30...+85°C
 Raster: 5,08 mm

Kapacitet (pF)	Cena	Tolerancija	D mm
1	0,25	± 0,25 pF	4,0
1,2	0,25	± 0,25 pF	4,0
1,5	0,25	± 0,25 pF	4,0
1,8	0,25	± 0,25 pF	4,0
2,2	0,25	± 0,25 pF	4,0
2,7	0,25	± 0,25 pF	4,0
3,3	0,25	± 0,25 pF	4,0
3,9	0,25	± 0,25 pF	4,0
4,7	0,25	± 0,25 pF	4,0
5,6	0,25	± 0,25 pF	4,0
6,8	0,25	± 0,25 pF	4,0
8,2	0,25	± 0,25 pF	4,0
10	0,25	± 5 %	4,0
12	0,25	± 5 %	4,0
15	0,25	± 5 %	4,0
18	0,25	± 5 %	4,0
22	0,25	± 5 %	4,0
27	0,25	± 5 %	4,0
33	0,25	± 5 %	4,0
39	0,25	± 5 %	4,0
47	0,25	± 5 %	4,0
56	0,25	± 10 %	4,0
68	0,25	± 10 %	4,0
82	0,25	± 10 %	4,0
100	0,35	± 10 %	4,0
120	0,35	± 10 %	4,0
150	0,35	± 10 %	4,0
180	0,35	± 10 %	4,0
220	0,35	± 10 %	4,0
270	0,35	± 10 %	4,0
330	0,35	± 10 %	4,0
390	0,35	± 10 %	4,0
470	0,35	± 10 %	4,0
560	0,35	± 10 %	4,0
680	0,35	± 10 %	5,0
820	0,35	± 20 %	5,0

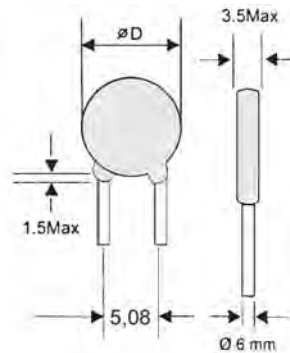

C (nF)	Cena	Tolerancija	D mm
1	0,40	± 20%	6
1,2	0,40	-20 / +50%	8
1,5	0,40	-20 / +50%	8
2,2	0,40	-20 / +50%	8
3,3	0,40	-20 / +50%	13
4,7	0,40	-20 / +50%	15
6,8	0,40	-20 / +50%	15
8,2	0,50	-20 / +50%	15
10	0,60	-20 / +50%	15
15	0,60	-20 / +50%	15
22	0,65	-20 / +50%	15
33	0,70	-20 / +50%	15
47	0,80	-20 / +50%	15





KONDENZATORI

KO

KERAMIČKI KONDENZATORI KOKE

KERAMIČKI KONDENZATORI 2, 4, 6, 8 KV, 400 V AC

Tehnički podaci

Tolerancija: ± 20%

Temperaturni opseg: -40 ... +85°C

2 KV

C	Cena	D	S
56pF	0,80	7,0	3,0
82pF	0,80	7,0	3,0
100pF	0,80	7,0	3,0
150pF	0,80	7,0	3,0
220pF	0,80	7,0	3,0
330pF	0,80	7,0	3,0
470pF	0,80	7,0	3,0
680pF	0,90	7,0	3,0
1nF	0,90	7,0	3,0
1,5nF	0,90	9,0	3,0
2,2nF	1,00	9,0	3,0
3,3nF	1,40	11,0	3,0
4,7nF	1,80	13,0	3,0
6,8nF	2,00	15,0	3,0
10nF	2,40	17,0	3,0

RM = Raster: 7,5 mm

6 KV

C	Cena	D	S
220pF	2,20	7,5	5,0
330pF	2,20	9,0	5,0
470pF	2,20	9,0	5,0
680pF	2,20	9,0	5,0
1nF	2,50	11,0	5,0

RM = Raster: 12,5 mm

8 KV

C	Cena	D	S
100pF	4,00	9,0	8,3
120pF	4,00	9,0	8,3
150pF	4,00	9,0	8,3
220pF	4,00	11,0	8,3
470pF	5,00	14,0	8,3
1nF	6,00	18,0	8,3
1,5nF	7,00	20,0	8,3
2,2nF	8,00	24,0	8,3

RM = Raster: 12,5 mm

4 KV

C	Cena	D	S
100pF	2,00	8,0	6,5
150pF	2,00	8,0	6,5
220pF	2,00	8,0	6,5
330pF	2,00	8,0	6,5
470pF	2,00	8,0	6,5
680pF	2,00	9,0	6,5
1nF	2,20	10,0	6,5
1,5nF	2,40	12,0	6,5
2,2nF	2,60	13,0	6,5
3,3nF	2,80	15,0	6,5
4,7nF	3,00	18,0	6,5

RM = Raster: 12,5 mm

400 V ~AC

C	Cena	D	S
33pF	1,50	8,0	6,5
47pF	1,50	8,0	6,5
68pF	1,50	8,0	6,5
100pF	1,50	8,0	6,5
220pF	1,50	8,0	6,5
330pF	1,50	8,0	6,5
470pF	1,50	8,0	6,5
680pF	1,50	9,0	6,5
1nF	1,60	10,0	6,5
2,2nF	2,30	13,0	6,5
3,3nF	3,00	15,0	6,5
4,7nF	3,60	18,0	6,5

RM = Raster: 12,5 mm

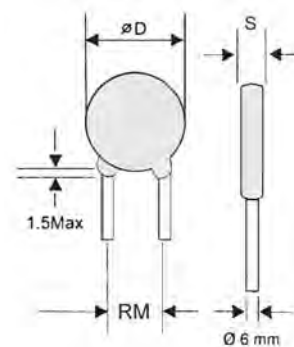



KONDENZATORI

KO

VIŠESLOJNI KERAMIČKI KONDENZATORI KOVK

Tehnički podaci:

Kapacitet: 10pf - 1μF
 Napon: 63-100V
 Tolerancija: ±5%...±20%
 Raster: 2,54 / 5,08 mm
 Temperaturni opseg: -40...+85°C

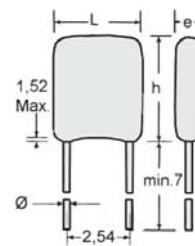

Kapacitet	Napon (V)	Cena	Tolerancija (%)	Dimenzije u mm		
				L	h	e
10pF	100	0,30	±5	3,8	5,3	2,5
15pF	100	0,30	±5	3,8	5,3	2,5
22pF	100	0,30	±5	3,8	5,3	2,5
33pF	100	0,30	±5	3,8	5,3	2,5
47pF	100	0,30	±5	3,8	5,3	2,5
68pF	100	0,30	±5	3,8	5,3	2,5
100pF	100	0,30	±5	3,8	5,3	2,5
120pF	100	0,30	±5	3,8	5,3	2,5
150pF	100	0,30	±5	3,8	5,3	2,5
220pF	100	0,30	±5	3,8	5,3	2,5
330pF	100	0,30	±5	3,8	5,3	2,5
470pF	100	0,30	±5	3,8	5,3	2,5
680pF	100	0,30	±5	3,8	5,3	2,5
820pF	100	0,30	±5	3,8	5,3	2,5
1nF	100	0,30	±10	3,8	5,3	2,5
1,5nF	100	0,30	±10	3,8	5,3	2,5
2,2nF	100	0,30	±10	3,8	5,3	2,5
3,3nF	100	0,30	±10	3,8	5,3	2,5
4,7nF	100	0,30	±10	3,8	5,3	2,5
6,8nF	100	0,30	±10	3,8	5,3	2,5
10nF	100	0,30	±10	3,8	5,3	2,5
15nF	100	0,30	±10	3,8	5,3	2,5
22nF	63	0,30	±20	3,8	5,3	2,5
33nF	63	0,30	±20	3,8	5,3	2,5
47nF	63	0,30	±20	3,8	5,3	2,5
68nF	63	0,30	±20	3,8	5,3	2,5
0,1μF	63	0,30	±20	3,8	5,3	2,5
0,15μF	63	0,35	±20	5,1	6,6	3,2
0,22μF	63	0,40	±20	5,1	6,6	3,2
0,33μF	63	0,50	±20	5,1	6,6	3,2
0,47μF	63	0,60	±20	5,1	6,6	3,2
0,68μF	63	0,90	±20	5,1	6,6	3,2
1μF	63	1,20	±20	7,6	9,2	3,8

	NP0	X7R	Z5U
Tip:	1	2	2
Tolerancija kapacitvnosti:	± 5%	± 10%	± 20%
Ispitni napon:	2,5 x U _N	2,5 x U _N	2,5 x U _N
Temperaturni sačinilac:	0 ± 30 ppm/°C	± 15%	+22-56%
Klima kategorija:	55/125/56	55/125/56	+22-56%
Tangens gubitaka:	15x10 ⁻⁴	250x10 ⁻⁴	300x10 ⁻⁴
Starenje:	0%	1%	5%
Otpor izolacije:			
CN ≤ 10 nF:	≥ 100 GΩ	≥ 100 GΩ	≥ 100 GΩ
CN > 10 nF:	R ₁ xCN≥1000s	R _x xCN≥1000s	R _x xCN≥100s

Obeležavanje:

- * Logo
- * Kapacitet - EIA -kod
- * Nominalni napon
- * Vrsta keramike
- * Tolerancija

Nominalni napon	Keramika	Tolerancija
D = 50/63V	C = NP0	J = ± 5%
E = 100V	Z = X7R	K = ± 10%
	W = Z5U	M = ± 20%

Norme:

NP0:	CECC30601-015, UTE/NFC83131
X7R:	CECC30701-045, UTE/NFC83132
Z5U:	CECC30701-044



KONDEZATORI

KO

POLIESTER - BLOK KONDEZATORI KOPB

Tehnički podaci

Tolerancija: ± 20%
 Temperaturni opseg: 55 ... +100°C

63V DC / 40V AC

C	Cena	Dimenzije u mm			
		B	H	L	RM
100pF	0,30	2,5	7,0	7,2	5,0
150pF	0,30	2,5	7,0	7,2	5,0
220pF	0,30	2,5	7,0	7,2	5,0
330pF	0,30	2,5	7,0	7,2	5,0
470pF	0,30	2,5	7,0	7,2	5,0
680pF	0,30	2,5	7,0	7,2	5,0
1nF	0,30	2,5	7,0	7,2	5,0
1,5nF	0,30	2,5	7,0	7,2	5,0
2,2nF	0,30	2,5	7,0	7,2	5,0
3,3nF	0,30	2,5	7,0	7,2	5,0
4,7nF	0,30	2,5	7,0	7,2	5,0
6,8nF	0,30	2,5	7,0	7,2	5,0
10nF	0,30	2,5	7,0	7,2	5,0
15nF	0,30	2,5	7,0	7,2	5,0
22nF	0,30	2,5	7,0	7,2	5,0
33nF	0,30	2,5	7,0	7,2	5,0
47nF	0,30	2,5	7,0	7,2	5,0
68nF	0,30	2,5	7,0	7,2	5,0
100nF	0,30	2,5	7,0	7,2	5,0
150nF	0,35	5,0	9,0	7,2	5,0
220nF	0,40	5,0	9,0	7,2	5,0
330nF	0,50	5,0	9,0	7,2	5,0
470nF	0,60	5,5	13,0	7,2	5,0
680nF	0,80	5,5	13,0	7,2	5,0
1µF	1,00	5,5	13,0	7,2	5,0
1,5µF	1,50	7,2	13,0	7,2	10,0
2,2µF	2,00	6,0	13,0	18,0	15,0
3,3µF	2,50	6,0	15,0	26,5	22,5
4,7µF	3,00	6,0	15,0	26,5	22,5
6,8µF	4,00	7,0	16,5	26,5	22,5
10µF	5,00	9,0	19,0	31,5	27,5
15µF	7,00	11	20,0	32,0	27,5

100V DC / 63V AC

C	Cena	Dimenzije u mm			
		B	H	L	RM
100pF	0,30	2,5	7,0	7,2	5,0
150pF	0,30	2,5	7,0	7,2	5,0
220pF	0,30	2,5	7,0	7,2	5,0
330pF	0,30	2,5	7,0	7,2	5,0
470pF	0,30	2,5	7,0	7,2	5,0
680pF	0,30	2,5	7,0	7,2	5,0
1nF	0,30	2,5	7,0	7,2	5,0
1,5nF	0,30	2,5	7,0	7,2	5,0
2,2nF	0,30	2,5	7,0	7,2	5,0
2,7nF	0,30	2,5	7,0	7,2	5,0
3,3nF	0,30	2,5	7,0	7,2	5,0
4,7nF	0,30	2,5	7,0	7,2	5,0
6,8nF	0,30	2,5	7,0	7,2	5,0
10nF	0,30	4,0	10,0	13,0	10,0
15nF	0,30	4,0	10,0	13,0	10,0
22nF	0,30	4,0	10,0	13,0	10,0
33nF	0,30	4,0	10,0	13,0	10,0
47nF	0,30	4,0	10,0	13,0	10,0
68nF	0,30	4,0	10,0	13,0	10,0
100nF	0,30	4,0	10,0	13,0	10,0
150nF	0,40	4,0	10,0	13,0	10,0
220nF	0,50	4,0	10,0	13,0	10,0
330nF	0,60	5,0	11,0	18,0	15,0
470nF	0,80	5,0	11,0	18,0	15,0
680nF	0,90	6,0	12,5	18,0	15,0
1µF	1,20	7,0	14,0	18,0	15,0
1,5µF	1,80	8,0	16,0	18,0	15,0
2,2µF	2,00	8,5	19,0	27,0	22,5
3,3µF	2,50	10,5	19,0	27,0	22,5
4,7µF	3,20	11,0	21,0	32,0	27,5
6,8µF	4,00	13,0	24,0	32,0	27,5
10µF	5,00	14,0	25,0	32,0	27,5

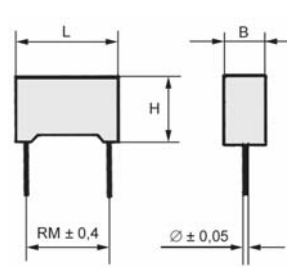



KONDENZATORI

KO

POLIESTER - BLOK KONDENZATORI KOPB

Tehnički podaci

Tolerancija: ± 20%
 Temperaturni opseg: 55 ... +100°C

250V DC / 160V AC

C	Cena	Dimenzije u mm			
		B	H	L	RM
100pF	0,35	4,5	6,0	7,2	5,0
150pF	0,35	4,5	6,0	7,2	5,0
220pF	0,35	4,5	6,0	7,2	5,0
330pF	0,35	4,5	6,0	7,2	5,0
470pF	0,35	4,5	6,0	7,2	5,0
680pF	0,35	4,5	6,0	7,2	5,0
1nF	0,35	4,5	6,0	7,2	5,0
1,5nF	0,35	4,5	6,0	7,2	5,0
2,2nF	0,35	4,5	6,0	7,2	5,0
3,3nF	0,35	5,5	7,0	7,2	5,0
4,7nF	0,35	6,5	8,0	7,2	5,0
6,8nF	0,35	7,0	9,0	7,2	5,0
10nF	0,35	5,0	11,0	13,0	10,0
15nF	0,35	5,0	11,0	13,0	10,0
22nF	0,35	5,0	11,0	13,0	10,0
33nF	0,35	5,0	11,0	13,0	10,0
47nF	0,40	5,0	11,0	13,0	10,0
68nF	0,45	5,0	11,0	13,0	10,0
100nF	0,50	5,0	11,0	18,0	15,0
150nF	0,70	5,0	11,0	18,0	15,0
220nF	0,80	5,0	11,0	18,0	15,0
330nF	0,90	7,0	17,0	27,0	22,5
470nF	1,00	7,0	17,0	27,0	22,5
680nF	1,20	7,0	17,0	27,0	22,5
1µF	1,50	7,0	17,0	27,0	22,5
1,5µF	2,50	13,0	24,0	32,0	27,5
2,2µF	3,00	13,0	24,0	32,0	27,5
3,3µF	3,50	13,0	24,0	32,0	27,5
4,7µF	5,00	13,0	24,0	32,0	27,5

400V DC / 200V AC

C	Cena	Dimenzije u mm			
		B	H	L	RM
100pF	0,35	2,5	6,5	7,2	5,0
150pF	0,35	2,5	6,5	7,2	5,0
220pF	0,35	2,5	6,5	7,2	5,0
330pF	0,35	2,5	6,5	7,2	5,0
470pF	0,35	2,5	6,5	7,2	5,0
680pF	0,35	2,5	6,5	7,2	5,0
1nF	0,35	5,0	11,0	13,0	10,0
1,5nF	0,35	5,0	11,0	13,0	10,0
2,2nF	0,35	5,0	11,0	13,0	10,0
3,3nF	0,35	5,0	11,0	13,0	10,0
4,7nF	0,35	5,0	11,0	13,0	10,0
6,8nF	0,35	5,0	11,0	13,0	10,0
10nF	0,50	5,0	11,0	18,0	15,0
15nF	0,60	5,0	11,0	18,0	15,0
22nF	0,60	5,0	11,0	18,0	15,0
33nF	0,70	5,0	11,0	18,0	15,0
47nF	0,70	5,0	11,0	18,0	15,0
68nF	0,70	5,0	11,0	18,0	15,0
100nF	0,80	5,0	11,0	18,0	15,0
150nF	0,90	7,0	17,0	27,0	22,5
220nF	1,00	7,0	17,0	27,0	22,5
330nF	1,20	7,0	17,0	27,0	22,5
470nF	1,30	7,0	17,0	27,0	22,5
680nF	1,60	13,0	24,0	32,0	27,5
1µF	2,00	13,0	24,0	32,0	27,5
1,5µF	3,00	13,0	24,0	32,0	27,5
2,2µF	4,00	13,0	24,0	32,0	27,5

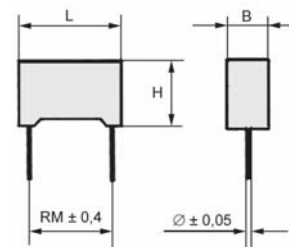



KONDENZATORI

KO

POLIESTER - BLOK KONDENZATORI KOPB

Tehnički podaci

Tolerancija: ± 20%
 Temperaturni opseg: 55 ... +100°C

630V DC / 220V AC

C	Cena	Dimenzije u mm			
		B	H	L	RM
100pF	0,60	4,5	6,0	7,2	5,0
150pF	0,60	4,5	6,0	7,2	5,0
220pF	0,60	4,5	6,0	7,2	5,0
330pF	0,60	4,5	6,0	7,2	5,0
470pF	0,60	4,5	6,0	7,2	5,0
680pF	0,60	4,5	6,0	7,2	5,0
1nF	0,60	4,5	6,0	7,2	5,0
1,5nF	0,60	4,5	6,0	7,2	5,0
2,2nF	0,60	5,5	7,0	7,2	5,0
3,3nF	0,60	6,5	8,0	7,2	5,0
4,7nF	0,60	6,5	8,0	7,2	5,0
6,8nF	0,60	7,2	8,5	7,2	5,0
10nF	0,60	5,0	11,0	13,0	10,0
15nF	0,65	5,0	11,0	13,0	10,0
22nF	0,70	5,0	11,0	13,0	10,0
33nF	0,80	5,0	11,0	18,0	15,0
47nF	0,80	6,0	12,5	18,0	15,0
68nF	0,80	7,0	14,0	18,0	15,0
100nF	0,80	7,0	17,0	27,0	22,5
150nF	0,90	7,0	17,0	27,0	22,5
220nF	1,00	11,0	19,0	27,0	22,5
330nF	1,20	13,0	24,0	32,0	27,5
470nF	1,50	13,0	24,0	32,0	27,5
680nF	2,50	13,0	25,0	33,0	27,5
1µF	3,00	13,0	25,0	33,0	27,5

1000V DC / 275V AC

C	Cena	Dimenzije u mm			
		B	H	L	RM
1nF	0,70	7,0	14,0	18,0	15,0
1,5nF	0,70	7,0	14,0	18,0	15,0
2,2nF	0,70	7,0	14,0	18,0	15,0
3,3nF	0,70	7,0	14,0	18,0	15,0
4,7nF	0,80	7,0	14,0	18,0	15,0
6,8nF	0,80	7,0	14,0	18,0	15,0
10nF	0,90	7,0	14,0	18,0	15,0
15nF	0,90	7,0	14,0	18,0	15,0
22nF	0,90	7,0	16,0	27,0	22,5
33nF	0,90	7,0	16,0	27,0	22,5
47nF	0,90	7,0	16,0	27,0	22,5
68nF	0,90	7,0	16,0	27,0	22,5
100nF	1,20	13,0	24,0	32,0	27,5
150nF	1,50	13,0	24,0	32,0	27,5
220nF	1,80	13,0	24,0	32,0	27,5
330nF	2,20	13,0	25,0	33,0	27,5
470nF	2,50	13,0	25,0	33,0	27,5
680nF	3,00	13,0	24,0	33,0	37,5
1µF	4,50	13,0	24,0	33,0	37,5
1,5µF	6,00	13,0	24,0	33,0	37,5
2,2µF	8,00	13,0	24,0	33,0	37,5

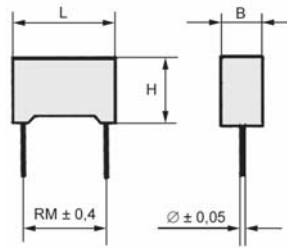

PRIMER ZA NARUČIVANJE KONDENZATORA

KOPB10nF630





KONDEZATORI

KO

POLIESTER - BLOK KONDEZATORI KOPB

Tehnički podaci

Tolerancija: $\pm 20\%$
 Temperaturni opseg: 55 ... +100°C

1600V DC / 500V AC

C	Cena	Dimenzije u mm			
		B	H	L	RM
100pF	0,90	7,0	14,0	18,0	15,0
150pF	0,90	7,0	14,0	18,0	15,0
220pF	0,90	7,0	14,0	18,0	15,0
330pF	0,90	7,0	14,0	18,0	15,0
470pF	0,90	7,0	14,0	18,0	15,0
680pF	0,90	7,0	14,0	18,0	15,0
1nF	1,00	7,0	14,0	18,0	15,0
1,5nF	1,20	7,0	16,0	27,0	22,5
2,2nF	1,30	7,0	16,0	27,0	22,5
3,3nF	1,40	7,0	16,0	27,0	22,5
4,7nF	1,60	7,0	16,0	27,0	22,5
6,8nF	1,80	7,0	16,0	27,0	22,5
7,5nF	1,80	7,0	16,0	27,0	22,5
8,2nF	1,90	7,0	16,0	27,0	22,5
10nF	2,00	13,0	24,0	32,0	37,5
15nF	2,50	13,0	24,0	32,0	37,5
22nF	3,00	13,0	24,0	32,0	37,5
33nF	3,50	13,0	24,0	32,0	37,5
47nF	4,00	13,0	24,0	32,0	37,5
68nF	5,00	13,0	24,0	32,0	37,5
100nF	6,00	13,0	24,0	32,0	37,5

2000V DC / 600V AC

C	Cena	Dimenzije u mm			
		B	H	L	RM
100pF	1,20	5,0	11,0	18,0	15,0
150pF	1,20	5,0	11,0	18,0	15,0
220pF	1,30	5,0	11,0	18,0	15,0
330pF	1,30	5,0	11,0	18,0	15,0
470pF	1,40	6,0	12,5	18,0	15,0
680pF	1,50	6,0	12,5	18,0	15,0
1nF	1,60	5,0	14,0	26,5	22,5
1,5nF	1,90	7,0	16,0	26,5	22,5
2,2nF	2,00	7,0	16,5	26,5	22,5
3,3nF	2,20	7,0	16,5	26,0	22,5
4,7nF	2,70	8,5	18,5	26,5	22,5
5,6nF	2,80	10,5	20,5	26,5	22,5
6,8nF	3,00	10,5	20,5	26,5	22,5
7,5nF	3,20	10,5	20,5	26,5	22,5
8,2nF	3,50	10,5	20,5	26,5	22,5
9,1nF	3,60	10,5	20,5	26,5	22,5
10nF	4,00	11,0	21,0	31,5	27,5
15nF	4,60	15,0	26,0	31,5	27,5
22nF	5,20	15,0	26,0	31,5	27,5
33nF	6,00	13,0	24,0	41,5	37,5
47nF	7,50	17,0	29,0	41,5	37,5

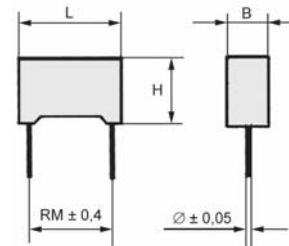

OBELEŽAVANJE POLIESTER KONDEZATORA

Boja	I	II	Multiplier	Tolerancija	Napon
Crna	-	0	x 1	$\pm 20\%$	250V
Braon	1	1	x 10	$\pm 1\%$	400V
Crvena	2	2	x 100	$\pm 2\%$	630V
Narandžasta	3	3	x 1000	$\pm 5\%$	
Žuta	4	4	x 10000	$\pm 10\%$	
Zelena	5	5	x 100000		
Plava	6	6			
Ljubičasta	7	7			
Siva	8	8			
Bela	9	9			



KONDENZATORI

KO

ELEKTROLITSKI KONDENZATORI KOEL

VERTIKALNI KOELV

Tehnički podaci:

Kapacitet: 0,1 - 6800 μ F
 Napon: 16-450V
 Tolerancija: \pm 20%
 Temperaturni opseg: -40...+85°C

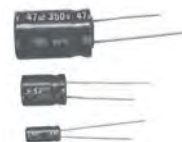
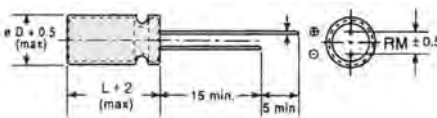

Kapacitet (μ F)	Napon (V)	Cena	Dimenzije u mm		
			D	L	RM
0,1	63	0,20	3,5	8	2,0
0,22	63	0,20	5	11	2,0
0,22	100	0,20	5	11	2,0
0,47	63	0,16	5	11	2,0
0,47	100	0,18	5	11	2,0
0,47	250	0,50	6	12	2,5
0,47	350	0,80	6	12	2,5
0,47	450	0,90	6	12	2,5
1	63	0,16	5	11	2,0
1	100	0,16	5	11	2,0
1	250	0,60	6	12	2,5
1	350	0,70	6	12	2,5
1	450	0,80	6	12	2,5
1,5	63	0,25	5	11	2,0
2,2	16	0,12	5	11	2,0
2,2	63	0,14	5	11	2,0
2,2	100	0,16	5	11	2,0
2,2	250	0,50	6	12	2,5
2,2	350	0,60	8	12	3,5
2,2	450	1,00	10	12	3,5
3,3	50	0,18	5	11	2,0
3,3	63	0,20	5	11	2,0
3,3	100	0,25	5	11	2,0
3,3	250	0,50	8	12	3,5
3,3	350	0,60	8	16	5,0
3,3	450	1,20	11	18	5,0
4,7	50	0,15	5	11	2,0
4,7	63	0,15	5	11	2,0
4,7	100	0,16	6	12	2,5
4,7	250	0,50	8	12	3,5
4,7	350	0,60	10	17	5,0
4,7	450	0,80	10	20	5,0
6,8	35	0,20	5	11	2,0

Kapacitet (μ F)	Napon (V)	Cena	Dimenzije u mm		
			D	L	RM
6,8	50	0,25	6	12	2,5
6,8	350	0,80	10	16	5,0
6,8	450	0,90	10	20	5,0
10	16	0,12	5	11	2,0
10	25	0,14	5	11	2,0
10	35	0,15	5	11	2,0
10	50	0,16	5	11	2,0
10	63	0,17	5	11	2,0
10	100	0,18	6	12	2,5
10	250	0,80	10	20	5,0
10	350	0,90	12	21	5,0
10	450	1,00	12	22	5,0
15	63	0,20	6	11	2,5
15	350	2,00	10	20	5,0
15	450	3,00	16	25	7,5
22	16	0,16	5	11	2,0
22	25	0,16	5	11	2,0
22	35	0,20	5	11	2,0
22	50	0,20	5	11	2,0
22	63	0,20	6	12	2,5
22	100	0,30	8	12	3,5
22	250	1,00	12	22	5,0
22	350	1,50	12	26	5,0
22	450	2,50	16	32	7,5
33	25	0,16	6	12	2,5
33	35	0,25	6	12	2,5
33	50	0,35	6	12	2,5
33	63	0,40	6	12	2,5
33	100	0,50	8	17	5,0
33	250	1,50	13	26	5,0
33	350	2,50	13	33	5,0
33	450	4,00	16	36	7,5
47	16	0,16	5	11	2,0



KONDENZATORI

KO

ELEKTROLITSKI KONDENZATORI KOEL

VERTIKALNI KOELV

Kapacitet (μ F)	Napon (V)	Cena	Dimenzije u mm		
			D	L	RM
47	25	0,16	5	11	2,0
47	35	0,20	6	12	2,5
47	50	0,22	6	12	2,5
47	63	0,30	8	12	3,5
47	100	0,40	8	17	5,0
47	160	1,20	12	26	5,0
47	250	2,50	13	29	5,0
47	350	3,00	16	32	7,5
47	400	4,00	16	34	7,5
68	25	0,25	6	12	2,5
68	35	0,30	8	12	3,5
68	63	0,80	8	16	5,0
68	350	5,50	16	32	7,5
68	400	8,00	22	40	10
100	16	0,18	6	11	2,5
100	25	0,20	6	12	2,5
100	35	0,30	8	12	3,5
100	50	0,35	8	12	3,5
100	63	0,50	8	16	5,0
100	100	0,80	10	21	5,0
100	250	4,00	16	41	7,5
100	350	5,00	20	41	10
100	400	9,00	22	41	10
150	25	0,30	8	12	3,5
150	35	0,80	10	12	3,5
150	63	0,90	10	20	5,0
150	350	9,00	20	41	10
220	16	0,30	8	12	3,5
220	25	0,32	8	12	3,5
220	35	0,45	8	16	5,0
220	50	0,60	10	17	5,0
220	63	0,70	10	20	5,0
220	100	1,80	12	26	5,0
220	250	9,00	20	41	10
220	350	12,00	25	41	10
330	16	0,25	8	12	3,5
330	25	0,40	8	16	5,0
330	35	0,60	10	17	5,0
330	50	0,80	10	20	5,0
330	63	1,10	12	22	5,0

Kapacitet (μ F)	Napon (V)	Cena	Dimenzije u mm		
			D	L	RM
330	350	16,00	25	45	12,5
470	16	0,40	8	14	5,0
470	25	0,50	8	16	5,0
470	35	0,70	10	21	5,0
470	50	1,00	12	22	5,0
470	63	1,40	12	26	5,0
470	100	4,00	16	34	7,5
680	16	0,80	8	16	5,0
680	35	1,20	10	18	5,0
680	50	1,50	16	26	7,5
1000	16	0,65	10	17	5,0
1000	25	1,00	10	20	5,0
1000	35	1,40	13	21	5,0
1000	50	2,00	16	27	7,5
1000	63	3,50	16	34	7,5
1000	100	7,00	20	34	10
1500	16	1,00	12	22	5,0
1500	25	1,50	12	25	5,0
1500	35	2,00	16	26	7,5
1500	50	3,20	16	31	7,5
2200	16	1,20	13	21	5,0
2200	25	1,60	16	26	7,5
2200	35	2,50	16	31	7,5
2200	50	4,00	18	34	7,5
2200	63	8,00	20	34	10
3300	16	1,50	13	25	5,0
3300	25	2,80	16	26	7,5
3300	35	4,00	18	34	7,5
3300	50	5,00	18	40	7,5
3300	63	8,00	20	40	10
4700	16	2,50	16	26	7,5
4700	25	3,20	16	34	7,5
4700	35	5,00	22	40	7,5
4700	63	10,00	25	43	10
6800	16	3,00	16	40	7,5
6800	25	6,00	18	42	7,5
6800	50	10,00	25	45	12,5

EEA 1011
 EEA 2011
 EEA 2081





KONDENZATORI

KO

ELEKTROLITSKI KONDENZATORI. KOEL
HORIZONTALNI KOELH

Tehnički podaci:

Kapacitet: 0,47 - 10000 μ F
 Napon: 16-450V
 Tolerancija: \pm 20%
 Temperaturni opseg: -40...+85°C



Kapacitet (μ F)	Napon (V)	Cena	Dimenzije u mm	
			D	L
0,47	63	0,40	5	12
0,47	100	0,50	5	12
1	63	0,40	5	12
1	100	0,70	5	12
1	350	1,00	8	16
2,2	63	0,40	5	12
2,2	100	0,60	5	12
2,2	350	1,20	10	17
2,2	450	1,60	10	17
3,3	63	0,60	6	12
3,3	100	0,65	6	12
4,7	16	0,30	5	12
4,7	50	0,50	5	12
4,7	63	0,60	5	12
4,7	100	0,60	6	12
4,7	350	1,60	10	21
4,7	450	2,50	13	22
6,8	63	0,70	6	12
6,8	100	0,80	6	16
10	35	0,50	5	12
10	50	0,60	6	12
10	63	0,70	6	12
10	100	0,80	8	16
10	350	2,00	13	22
10	450	3,00	16	28
22	25	0,50	5	12
22	35	0,60	6	12
22	50	0,65	6	12
22	63	0,70	6	13

Kapacitet (μ F)	Napon (V)	Cena	Dimenzije u mm	
			D	L
22	100	0,70	8	16
22	250	2,50	13	27
22	350	3,00	16	32
22	450	4,00	16	33
33	35	0,50	6	13
33	50	0,60	6	13
33	63	0,70	8	13
33	100	0,90	10	17
33	350	3,50	16	33
47	16	0,40	6	12
47	25	0,50	6	12
47	35	0,60	6	13
47	50	0,70	8	16
47	63	0,80	8	16
47	100	1,00	10	17
47	350	5,00	16	28
68	16	0,50	6	13
68	25	0,60	6	13
68	63	0,80	8	16
100	16	0,40	6	16
100	25	0,60	8	13
100	50	0,80	8	17
100	63	1,00	10	17
100	100	1,60	13	26
100	350	7,00	22	43
150	16	0,80	8	16
150	63	1,00	10	17
220	16	0,70	8	13
220	25	0,80	8	16



KONDENZATORI

KO

ELEKTROLITSKI KONDENZATORI. KOEL
 HORIZONTALNI KOELH

Kapacitet (μ F)	Napon (V)	Cena	Dimenzije u mm	
			D	L
220	35	1,00	10	17
220	50	1,20	10	17
220	63	1,50	10	22
220	100	2,50	16	28
220	250	9,00	22	43
330	16	0,80	8	13
330	25	0,90	8	16
330	35	1,00	10	22
330	50	1,20	13	22
330	63	2,00	12	27
330	100	3,00	16	33
470	16	0,90	8	17
470	25	1,20	10	17
470	35	1,50	10	22
470	50	2,00	13	22
470	63	2,20	13	22
470	100	4,00	16	37
680	25	2,00	13	22
680	50	2,50	13	27
680	63	3,20	16	27
1000	16	1,20	10	21
1000	25	1,50	10	22
1000	35	2,20	13	22
1000	50	3,00	16	33
1000	63	4,00	18	33
1000	100	8,00	22	43
2200	16	2,00	13	22
2200	25	2,50	13	28
2200	35	3,50	16	32
2200	50	5,00	18	40
2200	63	9,00	22	43
2200	100	16,00	28	52
3300	16	3,00	13	28
3300	25	3,50	16	33

Kapacitet (μ F)	Napon (V)	Cena	Dimenzije u mm	
			D	L
3300	35	6,00	22	43
3300	50	8,00	22	43
3300	63	10,00	22	45
4700	16	3,00	16	33
4700	25	4,00	18	33
4700	35	8,00	22	40
4700	50	10,00	25	45
4700	63	12,00	30	50
10000	16	8,00	22	40
10000	25	16,00	30	45

Iskra



EEA 1071
 EEA 1141
 EEA 2141
 EEA 2271
 EEA 2341
 EEA 2071

KEA - 600
 KEA - 601
 KEA - 700
 KEA - 701

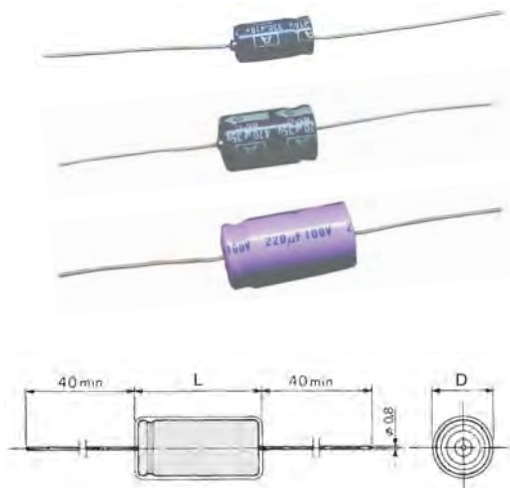



KONDENZATORI

KO

ELEKTROLITSKI KONDENZATORI. KOEL STOJEĆI - SNAP IN KOELS

Tehnički podaci

Kapacitet: 47 μ F - 2200 μ F
 Napon: 25-400V DC
 Tolerancija kapacitivnosti: \pm 20%
 Temperaturni opseg: 25-100V -40...+85°C
 200-400V -25...+85°C
 Vek trajanja: 2000h



Kapacitet (μ F)	Napon (V)	Cena	tan δ %	I _R (A)	Z (Ω)	Dimenzije u mm	
						D	L
47	400	7,00	0,25	0,43	8	22	25
100	400	9,00	0,25	0,68	8	22	30
220	385	12,00	0,25	1,27	8	22	50
330	250	9,00	0,20	1,42	6	30	25
470	250	12,00	0,25	1,92	8	30	40
470	400	18,00	0,25	2,19	8	35	45
1000	250	22,00	0,20	3,60	6	35	45
2200	50	8,00	0,30	1,92	4	22	25
2200	63	10,00	0,30	2,41	4	30	60
2200	100	12,00	0,30	2,81	4	35	80
3300	50	7,00	0,30	2,51	4	22	35
4700	35	9,00	0,35	2,41	4	22	30
4700	50	10,00	0,30	2,89	4	22	40
4700	63	12,00	0,25	4,86	4	30	30
4700	100	22,00	0,30	4,97	4	40	60
6800	35	12,00	0,35	2,98	4	22	40
10000	10	10,00	0,30	3,60	4	33	50
10000	16	9,00	0,40	3,72	4	30	45
10000	25	10,00	0,40	3,78	4	25	30
10000	35	12,00	0,35	4,42	4	45	90
10000	50	16,00	0,30	3,72	4	30	45
10000	63	22,00	0,40	3,78	4	50	80
10000	100	28,00	0,40	4,08	4	55	90
15000	25	11,00	0,40	3,78	4	25	40
15000	35	15,00	0,35	4,08	4	30	45
22000	25	16,00	0,40	6,10	4	25	50

C = Kapacitivnost, U_N = Nominalni napon, tan δ = Faktor gubitaka (120Hz, 25°C), I_R = Dozvoljena naizmjenična struja (85°C, 120 Hz), Z = Impedansa (-25...+25°C, 120 Hz)

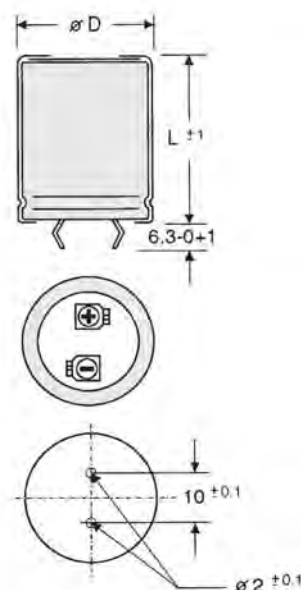

EEA 1241
 EEA 2021
 EEA 2231
 EEA 2241

KEA - 604
 KEA - 607
 KEA - 704
 KEA - 707



KONDENZATORI

KO

ELEKTROLITSKI KONDENZATORI. KOEL STOJEĆI - SA NAVOJEM KOELSN

Tehnički podaci

Kapacitet: 3300 μ F - 47000 μ F
 Napon: 25-400V DC
 Tolerancija kapacitivnosti: \pm 20%
 Temperaturni opseg: 25-100V -40...+85°C
 200-400V -25...+85°C
 Vek trajanja: 2000h

Kapacitet (μ F)	Napon (V)	Cena	I _R (A)	Z (Ω)	Dimenzije u mm	
					D	L
2200	63	14,00	2,6	70	30	36
3300	63	14,00	2,9	65	40	62
4700	25	12,00	2,6	60	40	40
4700	35	14,00	2,9	60	30	36
4700	63	17,00	4,0	50	35	52
4700	100	26,00	4,3	50	35	84
10000	25	16,00	4,3	50	40	60
10000	35	18,00	4,5	40	35	52
10000	63	23,00	5,5	30	35	84
10000	100	42,00	5,4	40	51	102
15000	35	22,00	5,8	30	35	62
15000	63	28,00	6,5	35	35	102
15000	100	48,00	8,5	28	51	122
22000	25	22,00	8,5	30	45	80
22000	35	24,00	7,9	30	35	84
22000	63	26,00	7,0	30	51	102
22000	100	68,00	9,1	20	64	122
33000	35	26,00	10,5	25	35	102
33000	63	42,00	9,5	25	63	112
33000	100	98,00	12,5	18	75	122
47000	35	32,00	13,0	23	51	102
47000	63	78,00	11,5	20	64	112

C = Kapacitivnost, U_N = Nominalni napon,
 I_R = Dozvoljena naizmenična struja (85°C, 120 Hz),
 Z = Impedansa (-25...+25°C, 120 Hz)



EEA 1221
 EEA 2031
 EEA 2121
 EEA 2221



KEA - 605
 KEA - 636

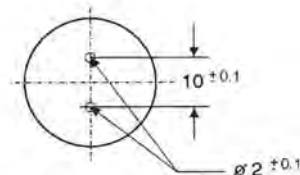
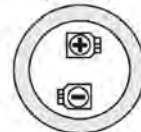
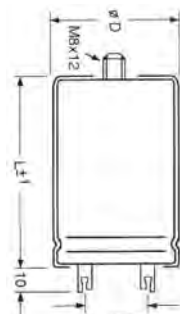



KONDENZATORI

KO

ELEKTROLITSKI KONDENZATORI. KOEL LOW ESR HIGH FREQUENCY 105°C KOELE

Tehnički podaci

Nominalni napon: 25-63V
Tolerancija kapacitivnosti: ± 20%
Radna temperatura: -55...+105°C
Struja gubitaka: $I_L < 0,01 \times C \times U_N$ ili 4μA
Vek trajanja: 5000 h

$$U_N [V=] \quad U_P [V] \quad \tan \delta [\%]$$

- * Viši temperaturni opseg (do 105°C)
- * Niža impedansa i niži R_{ESR}
- * Dug vek trajanja
- * Malih dimenzija
- * Primena u mrežnim stepenima

Kapacitet (μF)	Napon (V)	Cena	R_{ESR} (Ω)	I_R (mA)	Dimenzije u mm			
					D	L	RM	d
10	50	0,30	2	100	5,0	11	2,0	0,5
10	63	0,35	1,9	105	5,0	11	2,0	0,5
22	25	0,30	2	120	5,0	11	2,0	0,5
22	50	0,40	1,3	135	6,3	11	2,5	0,5
22	63	0,60	0,8	150	6,3	11	2,5	0,5
47	25	0,40	1,3	230	6,3	11	2,5	0,5
47	50	0,70	0,7	285	8,0	12	3,5	0,5
47	63	1,00	0,56	351	8,0	12	3,5	0,5
100	25	0,60	0,35	300	8,0	12	3,5	0,5
100	50	0,90	0,17	475	8,0	20	3,5	0,5
100	63	1,80	0,14	630	10,0	20	5,0	0,6
220	25	0,90	0,156	550	8,0	16	3,5	0,5
220	50	1,60	0,076	810	10,0	25	5,0	0,6
220	63	2,20	0,07	870	13,0	21	5,0	0,6
470	25	1,50	0,076	1040	10,0	20	5,0	0,6
470	50	3,00	0,055	1490	13,0	25	5,0	0,6
470	63	4,00	0,05	1430	16,0	25,5	7,5	0,8
1000	25	3,00	0,041	1430	13,0	25	5,0	0,6
1000	50	5,00	0,036	1880	16,0	31,5	7,5	0,8
1000	63	7,00	0,032	2110	16,0	41	7,5	0,8
2200	25	4,00	0,036	2390	13,0	40	5,0	0,6

C = nominalni kapacitet, R_{ESR} = impedansa, max (20°C, 120 kHz), I_R = Ripple Current 105°C, 100 KHz

U_N (V=)	U_P (V)	$\tan \delta$ δ
25	32	9
50	63	6
63	79	5

U_N = Nominalni napon DC, U_P = Prenapon, $\tan \delta$ = faktor gubitaka (120Hz, 25°C), za vrednosti >1000μF se dodaje po 2% na svakih 1000μF

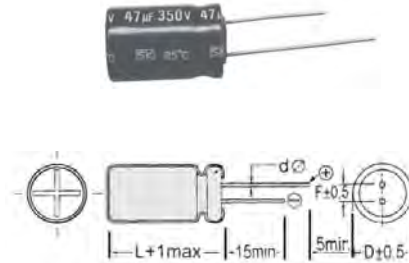

f = (Vek trajanja)

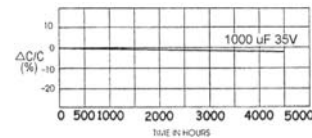

Faktor gubitaka
f = (Vek trajanja)

Promena kapaciteta

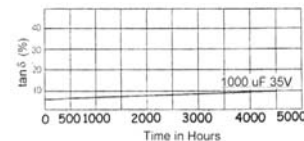

Struja gubitaka
f = (Vek trajanja)

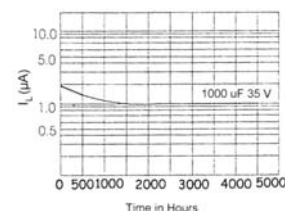



KONDEZATORI

KO

BIPOLARNI KONDEZATORI KOBİ ELEKTROLITSKI KONDEZATORI ZA TONSKE FREKVENCİJE

Tehnički podaci

Nominalni napon: 100V DC (35V AC)
 Tolerancija kapacitivnosti: ± 20%
 Temperaturni opseg: -40...+85°C
 Vek trajanja: +40°C >50.000h
 +85°C >2.500h
 +105°C >500h

C (μF)	Cena	U _N (V=)	tan δ	R _{ESR} (Ω)	Z (Ω)	D (mm)	L (mm)
1	1,20	100	0,07	11,5	18,0	10	20
2,2	1,30	100	0,07	5,8	9,0	10	30
3,3	1,40	100	0,07	3,8	5,8	10	30
4,7	1,50	100	0,06	2,7	4,0	10	30
6,8	1,60	100	0,06	1,8	2,6	10	30
10	1,80	100	0,06	1,2	1,8	10	30
15	2,00	100	0,05	0,65	1,2	10	30
22	2,20	100	0,05	0,44	0,74	12	30
33	2,50	100	0,05	0,28	0,52	12	30
47	3,00	100	0,05	0,20	0,36	14	37
68	4,00	100	0,05	0,13	0,26	16	39
100	4,50	100	0,05	0,09	0,16	18	39

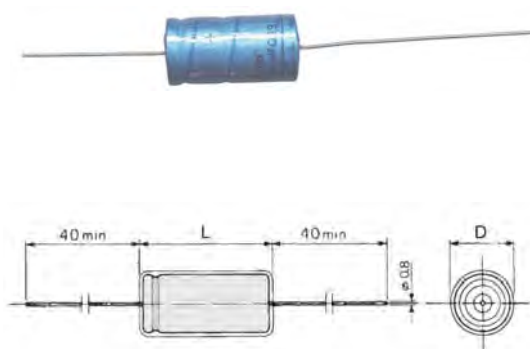

EEB 0041
 EEB 0071
 EEB 0141
 EEB 2071
 EEB 2141
 KEA - 650
 KEA - 651

C = nominalni kapacitet, U_N = nominalni napon tanδ = faktor gubitaka (1kHz, 25°C), R_{ESR} = ekvivalentni serijski otpor (1kHz, 250°C), Z = impedansa (10kHz, 20°C)

C (μF)	Frekvencija (Hz)								
	50	100	200	500	1000	2000	5000	10000	20000
1	7	15	25	40	60	80	90	110	120
2,2	20	30	40	60	90	110	120	150	160
3,3	30	40	55	85	120	140	160	200	210
4,7	40	50	70	110	160	190	210	250	270
6,8	55	70	100	150	205	240	280	330	360
10	70	90	120	190	270	320	350	430	460
15	100	140	190	280	390	430	500	580	620
22	140	190	250	390	540	590	650	790	830
33	180	250	350	520	710	780	900	1020	1100
47	210	310	420	640	890	1020	1200	1310	1400
68	290	420	590	810	1180	1310	1480	1620	1750
100	380	500	640	1000	1400	1600	1900	2200	2300

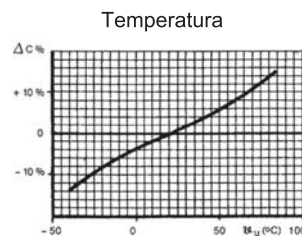
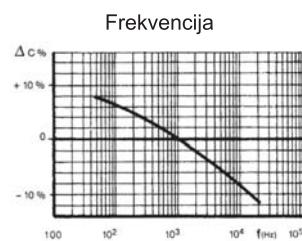



KONDENZATORI

KO

TANTAL KONDENZATORI KOTA

Tehnički podaci

Kapacitet: 0,1 μ F - 100 μ F
 Nominalni napon: 6,3 V, 10 V, 16 V, 25 V, 35 V
 Prenapon: 1,3 x U_N
 Tolerancija kapacitivnosti: $\pm 20\%$
 Temperaturni opseg: -55 +85°C



Kapacitet (μ F)	Napon (V)	Cena	U_{125} (V)	I_L (μ A)	tan δ %	Dimenzije u mm		
						D	H	RM
0,1	35	0,50	23	0,5	3	4,5	7,1	2,54
0,15	35	0,50	23	0,5	3	4,5	7,1	2,54
0,22	35	0,50	23	0,5	3	4,5	7,1	2,54
0,33	35	0,50	23	0,5	3	4,5	7,1	2,54
0,47	35	0,50	23	0,5	3	4,5	7,1	2,54
0,68	35	0,50	23	0,5	3	4,5	7,1	2,54
1	16	0,50	10	0,5	3	4,5	7,1	2,54
1	35	0,50	23	0,5	3	4,5	7,1	2,54
1	50	0,90	35	0,5	3	4,5	7,6	2,54
1,5	25	0,55	16	0,5	5	4,5	7,1	2,54
1,5	35	0,60	23	0,5	5	4,5	7,6	2,54
2,2	16	0,50	10	0,5	5	4,5	7,1	2,54
2,2	25	0,70	16	0,5	5	4,5	7,6	2,54
2,2	35	0,80	23	0,6	5	5,0	8,4	2,54
3,3	16	0,70	10	0,5	5	4,5	7,1	2,54
3,3	25	0,75	16	0,6	5	4,5	7,6	2,54
3,3	35	0,80	23	0,9	5	5,0	8,6	2,54
4,7	10	0,60	6,3	0,5	5	4,5	7,1	2,54
4,7	16	0,70	10	0,6	5	4,5	7,6	2,54
4,7	25	0,80	16	0,9	5	5,0	8,4	2,54
4,7	35	0,90	23	1,3	5	5,5	8,9	2,54
4,7	50	4,00	35	1,9	5	6,0	9,9	2,54
6,8	16	0,80	10	0,9	5	5,0	8,4	2,54
6,8	25	0,90	16	1,3	5	5,5	8,9	2,54
6,8	35	1,00	23	1,9	5	6,0	9,9	2,54
10	6,3	0,80	4	0,9	6	4,5	7,6	2,54
10	16	0,90	10	1,3	6	5,5	8,9	2,54
10	25	1,20	16	2,0	6	5,5	8,9	2,54
10	35	1,50	23	2,8	6	6,3	10,2	2,54
10	50	6,00	35	4,4	6	7,6	11,9	5,08
15	16	1,20	10	2,0	6	5,5	8,9	2,54

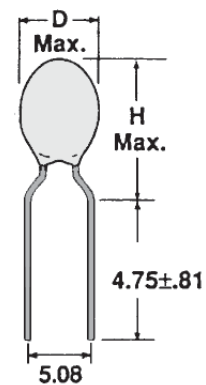
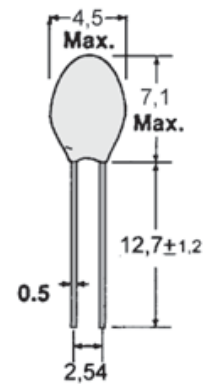



KONDEZATORI

KO

TANTAL KONDEZATORI KOTA

Kapacitet (μ F)	Napon (V)	Cena	U_{125} (V)	I_L (μ A)	$\tan \delta$ %	Dimenzije u mm		
						D	H	RM
15	25	2,00	16	2,8	6	6,3	10,2	2,54
15	35	4,00	23	4,6	6	7,6	11,9	2,54
22	6,3	0,80	4	1,3	6	5,5	8,9	2,54
22	16	1,40	10	2,6	6	6,0	9,9	2,54
22	25	4,00	16	4,4	6	7,6	11,9	5,08
22	35	5,00	23	6,2	6	8,9	15,5	5,08
33	16	2,80	10	4,0	6	7,6	10,2	2,54
33	25	6,00	16	6,2	6	7,6	11,9	2,54
33	35	8,00	23	6,6	6	8,4	14,0	5,08
47	6,3	2,00	4	2,8	6	7,6	11,9	2,54
47	16	4,00	10	5,6	6	8,4	14,0	5,08
47	25	7,00	16	9,4	6	8,9	15,5	5,08
47	35	10,00	23	10	6	8,9	16,5	5,08
68	16	6,00	10	6,2	6	8,9	15,5	5,08
68	25	9,00	16	6,8	7	8,9	16,5	5,08
100	16	9,00	10	10	8	8,9	18,1	5,08

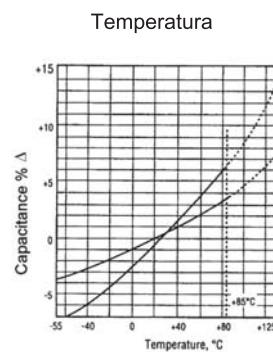
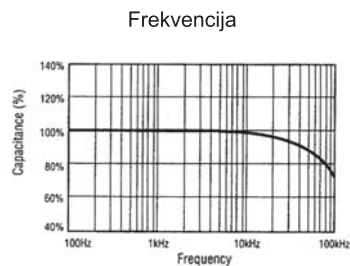

C = Kapacitivnost, U_N = nominalni napon, U_{125} = Redukcioni jednosmerni napon pri temperaturi do 125 °C, I_L = Struja gubitaka, $\tan \delta$ = Tangens gubitaka pri 25 °C i 120 Hz

OBELEŽAVANJE TANTAL KONDEZATORA

Boja	U_N (V)	Cn (μ F)		
		I	II	Multiplier
Crna	10	-	0	X 1
Braon	-	1	1	X 10
Crvena	-	2	2	
Oran%	-	3	3	
%uta	6,3	4	4	
Zelena	16	5	5	
Plava	20	6	6	
Ljubičasta	40	7	7	
Siva	25	8	8	X 0,01
Bela	3	9	9	0,1
Roze	35	-	-	

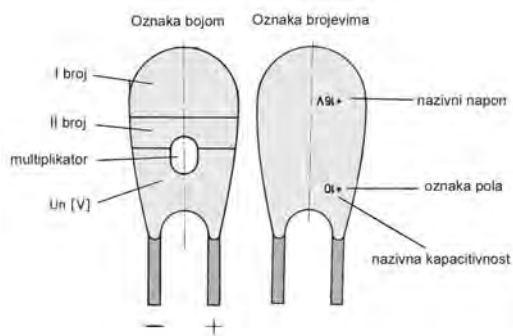



KONDENZATORI

KO

FILTERSKI KONDENZATORI KOELF

Tehnički podaci

Kapacitet: 1 - 200 μ F
 Napon: 450V
 Tolerancija kapacitivnosti: \pm 5%
 Učestanost: 200-400V -25...+85°C
 Temperaturni opseg: -25...+85°C

ZA RAD MOTORA · · KOELFM

Kapacitet (μ F)	Napon (V)	Cena	Dimenzije u mm	
			D \varnothing	L
1,0	450	4,50	28	55
1,5	450	5,00	28	55
2,0	450	5,00	28	55
2,5	450	5,00	28	55
3,0	450	5,00	28	55
3,5	450	5,00	28	55
4,0	450	5,00	28	55
4,5	450	5,50	28	55
5,0	450	6,00	32	55
6,0	450	6,00	32	55
6,3	450	6,00	32	55
8	450	6,00	32	55
10	450	7,00	36	58
11	450	7,00	36	58
12	450	7,00	36	70
14	450	8,00	36	70
16	450	8,50	40	70
18	450	10,00	40	70
20	450	10,00	40	70
25	450	11,00	40	92
30	450	12,00	40	92
40	450	15,00	45	92
50	450	18,00	45	117

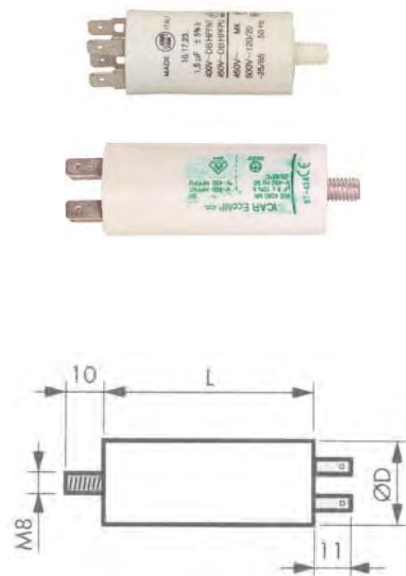

ZA START MOTORA · · KOELFS

Kapacitet (μ F)	Napon (V)	Cena	Dimenzije u mm	
			D \varnothing	L
30-40	320	9,00	40	70
40-50	320	9,00	40	70
50-60	320	10,00	40	70
60-80	320	12,00	36	70
80-100	320	12,00	40	92
100-120	320	12,00	45	117
120-150	320	13,00	45	117
150-200	320	14,00	40	110
200-250	320	18,00	45	128



EEB 9191
EEB 9201



FKM - 550
FKL - 550



KONDENZATORI

KO

FILTERSKI KONDENZATORI KOELF
 FILTERSKI KONDENZATORI SA KABLOM KOELFK

Tehnički podaci

Kapacitet: 1 - 60 μ F
 Napon: 450V
 Tolerancija kapacitivnosti: \pm 5%
 Učestanost: 200-400V -25...+85°C
 Temperaturni opseg: -25...+85°C



Kapacitet (μ F)	Napon (V)	Cena	Dimenzije u mm	
			D \varnothing	L
1,0	450	5,00	28	55
2,0	450	5,50	28	55
3,0	450	5,50	28	55
4,0	450	6,00	30	55
5,0	450	6,50	30	55
6,0	450	6,50	30	55
8,0	450	7,00	35	55
10	450	7,50	35	73
12	450	8,00	35	73
14	450	8,50	40	73
16	450	9,00	40	73
18	450	10,00	40	73
20	450	12,00	45	73
25	450	13,00	40	93
30	450	14,00	45	93
40	450	16,00	45	93
50	450	20,00	45	128
60	450	24,00	45	128

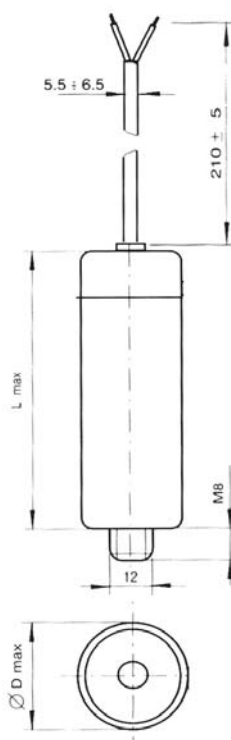

EEB 9211

FKM - 550
FKL - 550



KONDENZATORI

KO

KONDENZATORI ZA OTKLANJANJE RADIO SMETNJI KORS

Koriste se za suzbijanje radio i ostalih smetnji kod radio i TV prijemnika prouzrokovanih radom električnih uređaja koji imaju motore sa četkicama (usisivači, mlinovi, bušilice, veš mašine... itd). Ovi kondenzatori poseduju veliku električnu i mehaničku pouzdanost i koriste se tamo gde njihovo otkazivanje prouzrokovano kratkim spojem neće izazvati opasnost od strujnog udara. Kondenzatori klase X vezuju se između dve faze. Kondenzatori klase Y vezuju se između faze i uzemljenja. Mogu se koristiti pojedinačno ali se najčešće koriste tako što su dva ili više kondenzatora iste ili različite klase povezana u jedno kućište sa izvodima.

KONDENZATORI KLASA X1 . . . KORSX1

Tehnički podaci:

Kapacitet: 10 - 100nF
 Napon: 310V AC (50/60Hz)
 Tolerancija: ±20%
 Otpor izolacije: $\geq 1 \times 10^5 \text{M}\Omega$ ($5 \times 10^5 \text{M}\Omega$)
 Faktor gubitaka: $\tan \delta$ (1kHz $\pm 25^\circ\text{C}$) $\leq 10 \times 10^{-4}$ ($\leq 6 \times 10^{-4}$)
 Temperaturni opseg: -40...+110°C

C	Cena	du/dt V/ μs	Dimenzije u mm			
			B	H	L	RM
10nF	0,50	600	5,0	11,0	13,0	10,0
15nF	0,55	600	5,0	11,0	13,0	10,0
22nF	0,60	600	6,0	12,0	13,0	10,0
33nF	0,65	600	6,0	12,0	13,0	10,0
47nF	0,70	500	6,0	12,0	18,0	15,0
68nF	0,75	500	6,0	12,0	18,0	15,0
100nF	0,80	500	7,5	13,5	18,0	15,0

KONDENZATORI KLASA X2 . . . KORSX2

Tehnički podaci:

Kapacitet: 10n - 4,7 μF
 Napon: 275V AC (50/60Hz)
 Tolerancija: ±20%
 Otpor izolacije:
 C \leq 330nF $\geq 1 \times 10^5 \text{M}\Omega$ ($5 \times 10^5 \text{M}\Omega$)
 C \geq 330nF $\geq 30000\text{s}$ (150000s)
 Faktor gubitaka: $\tan \delta$ (1kHz $\pm 25^\circ\text{C}$) 10×10^{-4} ($\leq 6 \times 10^{-4}$)
 Temperaturni opseg: -40...+100°C

C	Cena	du/dt V/ μs	Dimenzije u mm			
			B	H	L	RM
10nF	0,50	400	5,0	11,0	18,0	15,0
15nF	0,50	400	5,0	11,0	18,0	15,0
22nF	0,55	400	5,0	11,0	18,0	15,0
33nF	0,55	400	5,0	11,0	18,0	15,0
47nF	0,60	400	5,0	11,0	18,0	15,0
68nF	0,65	400	5,0	11,0	18,0	15,0
100nF	0,70	400	6,0	12,0	18,0	15,0
150nF	0,75	400	7,5	13,5	18,0	15,0
220nf	0,80	200	6,0	15,0	26,5	22,5
330nF	0,90	200	7,0	16,0	26,5	22,5
470nF	1,20	200	10,0	18,5	26,5	22,5
680nF	1,40	150	10,0	20,0	32,0	27,5
1 μF	1,50	150	11,0	20,0	32,0	27,5
2,2 μF	2,80	150	14,0	28,0	32,0	27,5
3,3 μF	4,00	150	18,0	33,0	32,0	27,5
4,7 μF	5,00	150	22,0	37,0	32,0	27,5

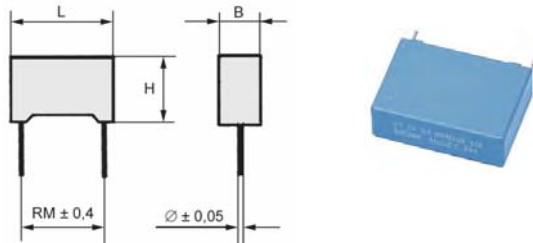

SA LICNASTIM IZVODIMA . . . KORSX2L

C	Cena	du/dt V/ μs	Dimenzije u mm		
			B	H	L
22nF	0,80	400	5,0	11,0	18,0
47nF	1,00	400	5,0	11,0	18,0

du/dt= impulsno opterećenje, max PM 390v DC

du/dt= impulsno opterećenje, max PM 390v DC



KONDENZATORI

KO

KONDENZATORI ZA OTKLANJANJE RADIO SMETNJI KORS KONDENZATORI KLASJE Y2 KORSY2

Tehnički podaci:

Kapacitet: 2,2n - 10nF
 Napon: 250V AC (50/60Hz)
 Tolerancija: ±20%
 Otpor izolacije: (25±5°C, 100V 1min) ≥ 3x10⁴MΩ
 Faktor gubitaka: tan δ (25±5°C, 1kHz) 100x10⁻⁴
 (350V DC): 500V/μs
 Probajni napon: (25±5°C) 2500VAC/1S-5000VDC/1S
 Temperaturni opseg: -40...+110°C

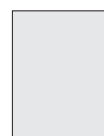

C	Cena	Dimenzije u mm			
		B	H	L	RM
2,2nF	0,50	4,0	9,0	13,0	10,0
3,3nF	0,60	5,0	11,0	13,0	10,0
4,7nF	0,70	5,0	11,0	13,0	10,0
10nF	0,80	5,0	11,0	13,0	15,0

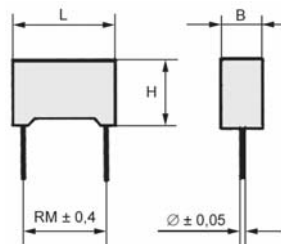

KONDEZATORI SERIJE KP-1A KORSKP1A

Tehnički podaci:

Napon: 250V AC (50/60Hz)
 Naponski test (2sec): provodnik-uzemljenje 2700VDC ili 1800VAC
 za Y kondenzatore
 provodnik-provodnik 1625DC ili 2500VAC
 za X kondenzatori
 Tolerancija: ±20%
 Otpor izolacije: (20⁰Um=100VDC) ≥ 6000MΩ
 Faktor gubitaka: tanδ ≤ 0,01 pri 1kHz
 Temperaturni opseg: -25...+85°C



DVA POLA KONDENZATORA KLASJE X1Y2

Tip	Cena	Kapacitet		I (mA)	Dimenzije (mm)	
		CX(μF)	CY(pF)		D	H
0,022	2,50	0,022	2x2500	0,216	12	30
0,047	2,50	0,047	2x2500	0,216	12	30
0,068	2,50	0,068	2x2500	0,216	12	30
0,1	2,50	0,1	2x2500	0,216	12	30

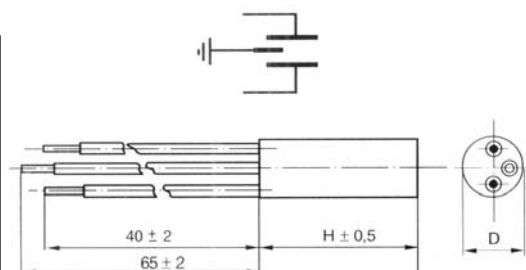



KONDEZATORI

KO

KONDEZATORI ZA OTKLANJANJE RADIO SMETNJI KORS

KONDEZATORI SERIJE KP-2A KORSKP2A

Tehnički podaci:

Napon: 250V AC (50/60Hz)
 Naponski test (2sec): provodnik-uzemljenje 2700VDC ili 1800VAC
 za Y kondenzatore
 provodnik-provodnik 1625DC ili 2500VAC
 za X kondenzatore
 Tolerancija: ±20%
 Otpor izolacije: $20^{\circ}U_m=100VDC \geq 6000M\Omega$
 Faktor gubitaka: $\tan\delta \leq 0,01$ pri 1kHz
 Temperaturni opseg: -25...+85°C



ČETIRI POLA KONDEZATORA KLASSE X1Y2

Tip	Cena	Kapacitet		I (mA)	Dimenzije (mm)	
		CX(μF)	CY(pF)		D	H
0,025	3,00	0,025	2x2500	0,216	12	32
0,047	3,00	0,047	2x2700	0,233	12	40
0,068	3,00	0,068	2x2700	0,233	12	45
0,1	3,00	0,1	2x2700	0,233	12	45

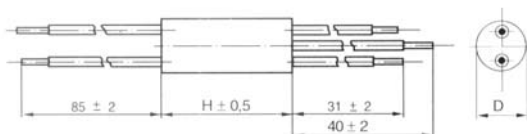
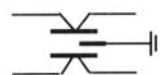

KONDEZATORI SERIJE KP-1B KORSKP1B

Tehnički podaci:

Napon: 250V AC (50/60Hz)
 Naponski test (2sec): provodnik-uzemljenje 2700VDC ili 1800VAC
 za Y kondenzatore
 provodnik-provodnik 1625DC ili 2500VAC
 za X kondenzatore
 Tolerancija: ±20%
 Otpor izolacije: $20^{\circ}U_m=100VDC \geq 6000M\Omega$
 Faktor gubitaka: $\tan\delta \leq 0,01$ pri 1kHz
 Temperaturni opseg: -25...+85°C



DVA POLA KONDEZATORA KLASSE X1Y2

Tip	Cena	Kapacitet		I (mA)	Dimenzije u mm		
		CX(μF)	CY(pF)		A	B	H
0,005	4,00	0,05	2x2500	0,216	20	10	27
0,075	4,00	0,075	2x2500	0,216	25	10	31
0,1	4,00	0,1	2x2500	0,216	22	9	42
0,22	4,00	0,22	2x2500	0,216	27	15	35
0,25	4,00	0,25	2x6800	0,587	30	18	35
0,3	4,00	0,3	2x2500	0,216	30	18	35

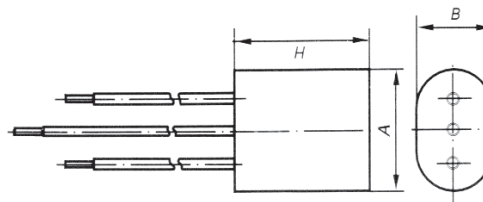
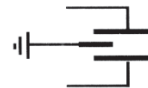



KONDENZATORI

KO

KONDENZATORI ZA OTKLANJANJE RADIO SMETNJI KORS KONDENZATORI SERIJE RLC KORSRLC

Tehnički podaci:

Napon: 250V AC (50/60Hz)
 Naponski test (2sec): provodnik-uzemljenje 2700VDC ili 1800VAC
 za Y kondenzatore
 provodnik-provodnik 1625DC ili 2500VAC
 za X kondenzatori
 Tolerancija: kapacitet $\pm 20\%$
 induktivnost $-30 + 50\%$
 Otpor izolacije: ($20^{\circ}\text{Um}=100\text{VDC} \geq 6000\text{M}\Omega$)
 Faktor gubitaka: $\tan\delta \leq 0,01$ pri 1kHz
 Temperaturni opseg: $-25...+85^{\circ}\text{C}$

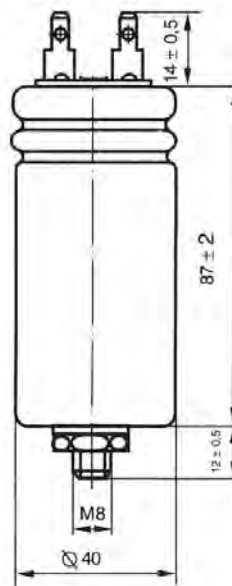

Tip	Cena	Kapacitet		L (mA)	R (M Ω)	I _R (A)	I _L (mA)
		CX(μF)	CY(pF)				
0,25	12,00	0,25	2x2700	2x0,3	1	16	0,233
0,47	14,00	0,47	2x4700	2x1	0,68	16	0,405
0,50	15,00	0,50	2x5000	2x1	2,2	16	0,432

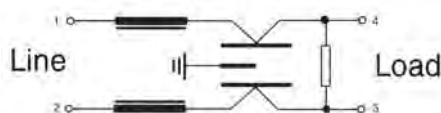

KONDENZATORI SERIJE AG / KIA KORSAG

Tehnički podaci:

Napon: 100-250V DC
 Naponski test (2sec): 200 - 500V DC
 Tolerancija: $\pm 10\%$
 Otpor izolacije: ($20^{\circ}\text{Um}=100\text{VDC} \geq 6000\text{M}\Omega$)
 Faktor gubitaka: $\leq 0,01$ pri 1kHz
 Temperaturni opseg: $-40...+85^{\circ}\text{C}$

Tip	Cena	Kapacitet (μF)	Napon (V)
AG	3,00	2,2	100
AG	3,00	0,47	250
KIA	2,50	0,22	250

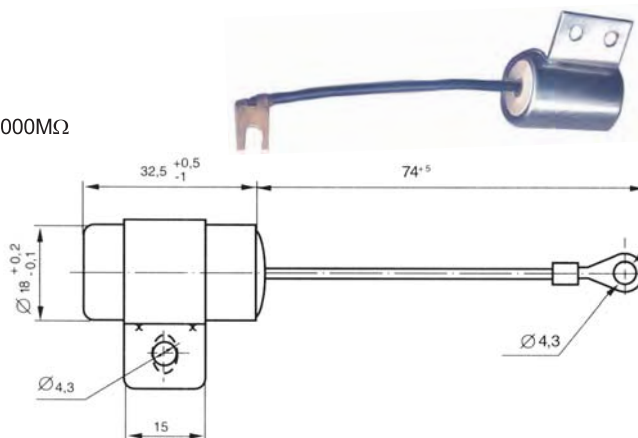



KONDENZATORI

KO

TRIMER KONDENZATORI KOTR

Tehnički podaci

Kapacitet: 1,4 - 105 pF
 Napon: 250V
 Tolerancija kapacitivnosti: ± 10% do +70°C
 Temperaturni opseg: -10...+80°C
 Podešavanje: 180°

Ø7,5 mm

Kapacitet (pF)	Cena	Boja	h (mm)
1,4-5,5	1,60	grao	10
2,0-10	1,60	%uta	10
2,0-22	1,80	zelena	10
2,0-27	1,80	crvena	10
3,0-40	2,00	violet	10

Ø10 mm

Kapacitet (pF)	Cena	Boja	h (mm)
5,5-40	2,40	grao	15
5,5-65	2,60	%uta	15
7-105	2,80	violet	15

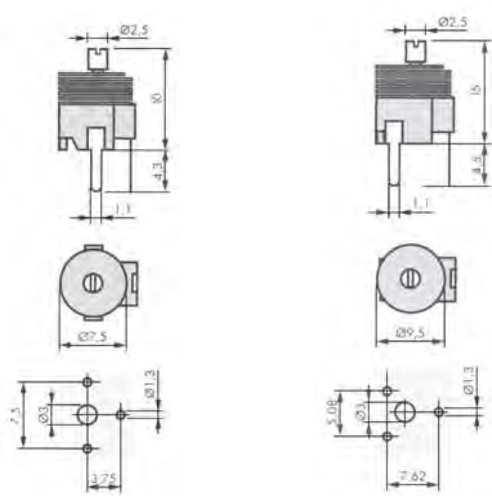

KONDENZATORI BACK - UP KOBU

Tehnički podaci

Kapacitet: 0,022-1F
 Napon: 5,5V DC
 Tolerancija kapacitivnosti: ± 20%
 Temperaturni opseg: -25...+70°C

Kapacitet (F)	Cena	Dimenzije u mm	
		Ø D	H
0,022	7,00	13,5	7,5
0,047	8,00	13,5	7,5
0,1	8,00	13,5	7,5
0,22	8,00	13,5	7,5
0,47	17,00	21,5	8,0
1	18,00	21,5	8,0

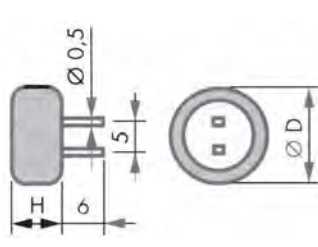



KONDEZATORI

KO

SMD KONDEZATORI KOSMD
 SMD KERAMIČKI KONDEZATORI KOSMDKE

06 – NPO 0603

08 – NPO 0805

12 – NPO 1206

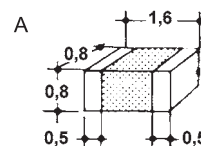
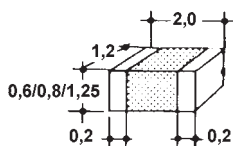
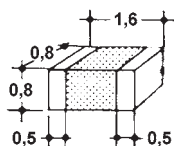

Tip	Cena	U(V)	Tol.(%)
10p	0,06	50	±5
22p	0,06	50	±5
33p	0,06	50	±5
47p	0,06	50	±5
68p	0,07	50	±5
100p	0,07	50	±5
150p	0,08	50	±5
220p	0,08	50	±5
330p	0,09	50	±5

Tip	Cena	U(V)	Tol.(%)
10p	0,06	63	±5
15p	0,06	63	±5
22p	0,06	63	±5
33p	0,06	63	±5
47p	0,06	63	±5
68p	0,07	63	±5
100p	0,08	63	±5
150p	0,09	63	±5
220p	0,10	63	±5
330p	0,11	63	±5
470p	0,14	63	±5
680p	0,17	63	±5
1N	0,20	63	±5

Tip	Cena	U(V)	Tol.(%)
3,3p	0,23	63	±5
8,2p	0,23	63	±5
10p	0,22	63	±5
15p	0,22	63	±5
22p	0,22	63	±5
33p	0,22	63	±5
47p	0,22	63	±5
68p	0,22	63	±5
100p	0,22	63	±5
150p	0,22	63	±5
220p	0,22	63	±5
330p	0,22	63	±5
470p	0,22	63	±5
680p	0,30	63	±5
1N	0,35	63	±5

12 - Z5U 1206

18 - Z5U 1812

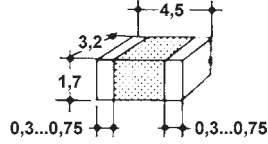
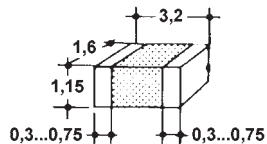

Tip	Cena	U(V)	Tol.(%)
100N	0,25	63	±5
220N	0,45	63	±5

Tip	Cena	U(V)	Tol.(%)
330N	1,60	63	±20
470N	1,60	63	±20



KONDEZATORI

KO

SMD KONDEZATORI KOSMD
 SMD VIŠESLOJNI KERAMIČKI KONDEZATORI KOSMDVK

06 – X7R 0603

08 – X7R 0805

12 – X7R 1206

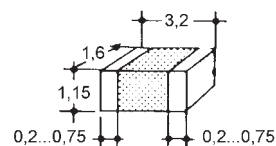
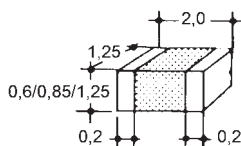
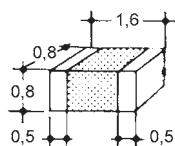

Tip	Cena	U(V)	Tol.(%)
1N	0,06	50	±10
1,5N	0,07	50	±10
2,2N	0,07	50	±10
3,3N	0,07	50	±10
4,7N	0,07	50	±10
6,8N	0,07	50	±10
10N	0,07	50	±10
22N	0,10	25	±10
33N	0,11	25	±10
100N	0,12	16	±10

Tip	Cena	U(V)	Tol.(%)
1N	0,06	63	±10
1,5N	0,07	63	±10
2,2N	0,07	63	±10
3,3N	0,07	63	±10
4,7N	0,07	63	±10
6,8N	0,07	63	±10
10N	0,07	63	±10
15N	0,08	63	±10
22N	0,09	63	±10
33N	0,13	63	±10
47N	0,15	63	±10
100N	0,20	25	±10

Tip	Cena	U(V)	Tol.(%)
1N	0,17	63	±10
1,5N	0,17	63	±10
2,2N	0,17	63	±10
3,3N	0,17	63	±10
4,7N	0,17	63	±10
10N	0,17	63	±10
15N	0,17	63	±10
22N	0,18	63	±10
33N	0,18	63	±10
47N	0,19	63	±10
68N	0,19	63	±10
100N	0,20	63	±10

SMD MKT BLOK KONDEZATORI KOSMDPB

Tip	Cena	Vrednost (F)	Napon (V)	Tol. (%)	Dimenzije u mm		
					L	W	H _{max.}
1812	0,60	10n	50	5	4,5	3,2	1,7
1812	0,70	33n	50	5	4,5	3,2	1,7
1812	0,80	47n	100	10	4,5	3,2	2,3
1812	0,90	100n	100	10	4,5	3,2	2,3
1812	1,00	220n	63	10	4,5	3,2	2,3
2220	1,60	330n	63	10	5,7	5,1	2,3
2824	1,80	1μ	100	10	10,2	7,6	3,6
5040	3,00	2,2μ	50	10	12,7	10,2	3,6
6054	7,00	4,7μ	50	10	15,2	13,7	4,5

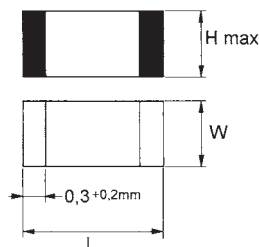



KONDENZATORI

KO

SMD KONDENZATORI KOSMD
 SMD ELEKTROLITSKI KONDENZATORI KOSMDEL

Tehnički podaci:

Nominalni napon: Videti tabelu
 Tolerancija kapacitivnosti: ±20%
 Temperaturni opseg: -40 +80°C
 Radni vek (85°C): 2000 h

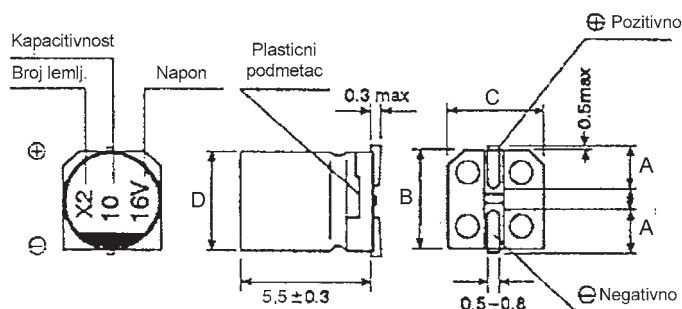

Tip	Cena	C (μF)	U _N (V=)	tan δ	I _R (mA)	Dimenzije u mm				
						D	A	B	C	E
1/50	0,50	1	50	0,12	10	4	1,8	4,3	4,3	1,0
2,2/50	0,60	2,2	50	0,12	15	4	1,8	4,3	4,3	1,0
4,7/35	0,50	4,7	35	0,12	20	4	1,8	4,3	4,3	1,0
4,7/50	0,60	4,7	50	0,12	23	5	2,1	5,3	5,3	1,3
10/35	0,60	10	35	0,12	30	5	2,1	5,3	5,3	1,3
10/50	0,70	10	50	0,12	34	6,3	2,4	6,6	6,6	2,2
22/16	0,70	22	16	0,12	50	6,3	2,4	6,6	6,6	2,2
22/35	0,80	22	35	0,12	54	6,3	2,4	6,6	6,6	2,2
47/16	0,80	47	16	0,16	63	6,3	2,4	6,6	6,6	2,2
100/16	0,80	100	16	0,16	86	6,3	2,4	6,6	6,6	2,2

C_N = Nominalna kapacitivnost, U_N = Nominalni napon, tan δ = tangens ugla gubitaka, I_R = nominalna naizmenična struja



KONDENZATORI

KO

SMD KONDENZATORI KOSMD

SMD TANTAL KONDENZATORI KOSMDTA

Tehnički podaci:

Nominalni napon: Videti tabelu
 Tolerancija kapacitivnosti: $\pm 20\%$
 Temperaturni opseg: $-55 \dots +85^\circ\text{C}$
 Struja gubitaka: $0,01 \times C_N \times U_N$ ili $4\mu\text{A}$
 Tang. ugla gubitaka $0,1$ do $1,0\mu\text{F}$: 4%
 $\tan \delta$: $1,5$ do $68\mu\text{F}$: 6%
 $C \geq 100,0\mu\text{F}$: 8%

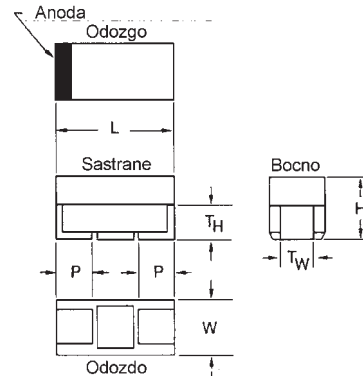

Tip	Cena	U_N (V=)	U_{125} (V=)	R_{ESR} (Ω)	I_R (mA)	Veličina čipa
0,1	0,90	35	23	24,0	54	A
0,22	0,90	35	23	18,0	62	A
0,47	0,90	25	16	14,0	71	A
0,47	1,00	35	23	10,0	89	B
1	0,90	16	10	20,0	80	A
1	1,00	35	23	11,0	110	B
2,2	1,00	25	16	4,5	133	B
2,2	1,50	35	23	3,5	177	C
3,3	1,00	16	10	4,4	135	B
4,7	1,50	25	16	2,4	214	C
4,7	2,10	35	23	1,5	315	D
6,8	2,20	35	23	1,3	340	D
10	1,50	16	10	2,2	224	C
10	2,10	35	23		387	D
22	1,60	6,3	4	2,2	224	C
22	2,10	20	13		408	D
33	2,10	16	10	0,9	408	D

C = Kapacitivnost, U_N = Nominalni napon DC na 85°C , R_{ESR} = Nominalni serijski otpor, I_R = Nominalna naizmenična struja

Veličina čipa	Dimenzije u mm					
	L	W	H	P	T_w	$T_{h \text{ min.}}$
A	3,2	1,6	1,6	0,8	1,2	0,7
B	3,5	2,8	1,9	0,8	2,2	0,7
C	6,0	3,2	2,5	1,3	2,2	1,0
D	7,3	4,3	2,8	1,3	2,4	1,0