

AI

Miniature limit switches

Univer limit switches, mounted on sub-bases with threaded connections or with quick couplings, may be combined with different types of manual operators for panel mounting complying with the various need of the plant.



TECHNICAL CHARACTERISTICS

Ambient temperature	-10 ÷ +90 °C
Fluid temperature	max +50 °C
Fluid	defiltered air 50 um not dehumidified, lubricated or not
Commutation system	poppet system
Ways/Positions	2/2 NC, 3/2 NC, 2/2 NO, 3/2 NO
Pressure	max 10 bar
Control	manual, mechanical
Return	mechanical spring
Connections	interface for sub-base
Nominal Ø	2,3 mm (1,5 sensible type)
Nominal flow rate (NI/min)	110 NI/min

CONSTRUCTIVE CHARACTERISTICS

Valve body	zamak
Seals	nitrile rubber
Sub-base	zamak
Spool	nickel-plated brass

Flow rate characteristics

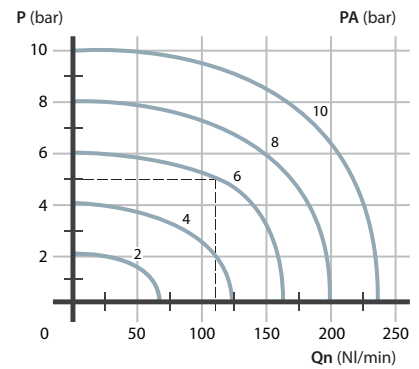

P = Working pressure
 PA = Supply pressure
 Qn = Flow rate

Mechanical push button - spring



- A Pre-stroke
- B Max opening
- C Total stroke
- D 3/2 NC - 3/2 NO - 2/2 NC
- E 2/2 NO

	Symbol	Ø mm	Flow rate NI/min	Force N	Weight Kg	Part no.
3/2 NC		2,3	110	15	0,040	AI-3500
		1,5	55	4	0,040	AI-3500S (a)
3/2 NO		2,3	110	15	0,040	AI-3501
		1,3	45	4	0,040	AI-3501S(a)
2/2 NC		2,3	110	15	0,040	AI-3502
2/2 NO (b)		2,3	110	15	0,040	AI-3503

(a) = sensible (b) = 2/2 NO version available upon request

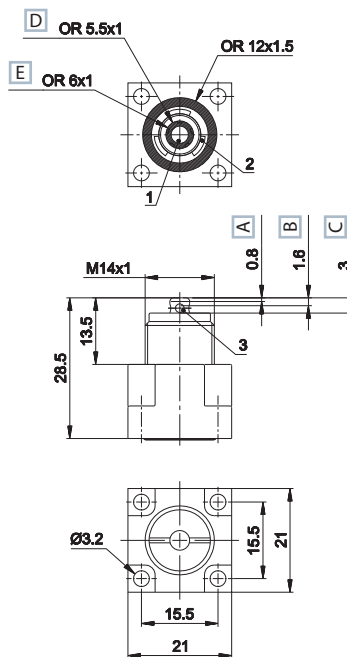

1 = Supply port
2 = Use
3 = Exhaust

PNEUMATIC AND MECHANICAL ACTUATORS

MANUAL PUSH

	Pneumatic operator	AI-3550			<ul style="list-style-type: none"> ■BLACK AI-3511 ■RED AI-3512 ■GREEN AI-3513
	Amplified pneumatic operator	AI-3551			<ul style="list-style-type: none"> ■RED AI-3514 ■BLACK AI-3516
	Roller operator 1 position	AI-3560			<ul style="list-style-type: none"> ■GREEN AI-3515 ■RED AI-3517 ■BLACK AI-3519
	Ball-push operator 1 position	AI-3562			<ul style="list-style-type: none"> ■BLACK AI-3520 ■BLACK AI-3521
	Operator with omni-directional antenna 1 position	AI-3563			<ul style="list-style-type: none"> ■BLACK AI-3522 ■BLACK AI-3523
	Roller lever operator 1 posizione	AI-3570			<ul style="list-style-type: none"> ■BLACK AI-3524
	Articulated roller operator 1 position Complete actuation with stroke 2,5 mm, max stroke 4,7 mm	AI-3571			<ul style="list-style-type: none"> ■BLACK AI-3525
	Key operator 1 position	AI-3572			<ul style="list-style-type: none"> ■BLACK AI-3526

For actuators dimensions see section "Accessories>Actuators"

Mechanical push button for panel mounting - spring



A 3/2 NC - 3/2 NO - 2/2
 B 2/2 NO

	Symbol	Ø mm	Flow rate Nl/min	Force N	Weight Kg	Part no.
3/2 NC		2,3	110	15	0,055	AI-3500Q
		1,5	55	4	0,055	AI-3500SQ (a)
3/2 NO		2,3	110	15	0,055	AI-3501Q
		1,3	45	4	0,055	AI-3501SQ (a)
2/2 NC		2,3	110	15	0,055	AI-3502Q
2/2 NO (b)		2,3	110	15	0,055	AI-3503Q

(a) = sensible (b) = upon request only 2/2 NO version

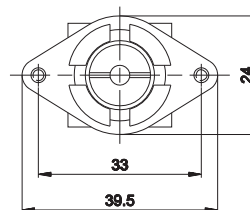
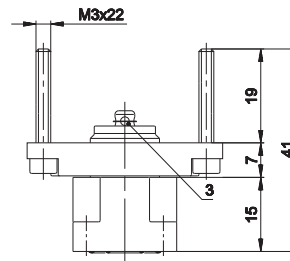
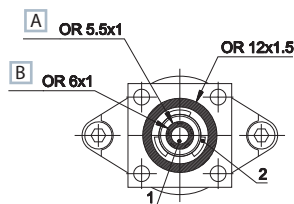

1 = Supply port
 2 = Use
 3 = Exhaust

MANUAL PUSH

	Recessed button	<ul style="list-style-type: none"> ■BLACK AI-3511Q ■RED AI-3512Q ■GREEN AI-3513Q
	Head button	<ul style="list-style-type: none"> ■RED AI-3514Q ■BLACK AI-3516Q ■RED AI-3514QD ■BLACK AI-3516QD
	Button	<ul style="list-style-type: none"> ■GREEN AI-3515Q ■RED AI-3517Q ■BLACK AI-3519Q
	Accident prevention rotating selector	<ul style="list-style-type: none"> ■BLACK AI-3520Q ■BLACK AI-3521Q
	Rotating lever selector	<ul style="list-style-type: none"> ■BLACK AI-3522Q ■BLACK AI-3523Q
	Lever operator	<ul style="list-style-type: none"> ■BLACK AI-3524Q
	Omni-directional operator	<ul style="list-style-type: none"> ■BLACK AI-3525Q
	Push-pull operator	<ul style="list-style-type: none"> ■BLACK AI-3526Q

For actuators dimensions see section "Accessories>Actuators"

AI-3610

AI-3610 + AI-3500

AI-3610 + AI-3500Q

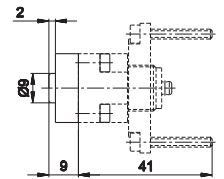
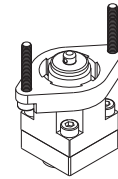
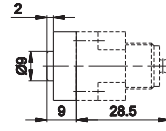
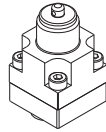
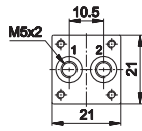
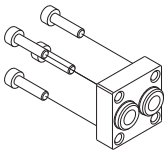

Sub-base with M5 threaded connections
weight: 0,020 Kg

AI-3612

AI-3612 + AI-3500

AI-3612 + AI-3500Q

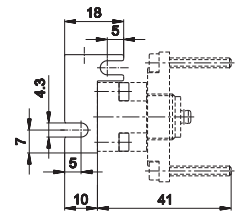
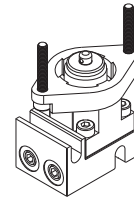
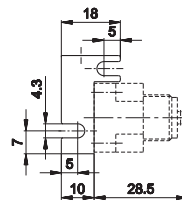
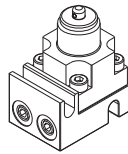
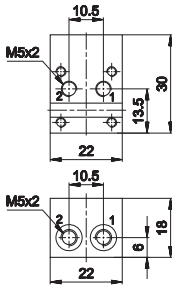
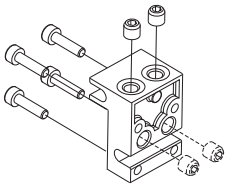

Sub-base with side or dorsal consumptions and threaded connections M5
weight: 0,020 Kg

Part numbers include M3x12 fixing screws (4 pcs) and M5x5 dowel pins to close the unused ways.
The M5x5 dowel pins must be mounted with loctite (243 type). Be sure that loctite does not obstruct the ports or sinks inside the valve.
The dowel pins must be screwed till reaching the base surface. Avoid screwing them completely.