



Електролюкс
Electrolux

Електролюкс

Ovaj crtez e sopstvenost na Electrolux-Bitola.Bez negovo pismeno odobruvanje istiot nesmee da se prepisuva , umozuva niti kopira bez soglasnost od Electroлux vo sprotivno se snosat posledici vo smislana clenovite 163 i 164 od kniviciot zakon R.M. (повреда на avtorsko pravo)

Product range overview
Programmubersicht
Einschraubheizkoper

Proizvosna programa
na EI.grejaci
tehnicka dokumentacija
i namena

1

Made in Electrolux-Macedonia

Adresa: ul.Braka Mingovi 18, 7000 Bitola; tel: 047/203-330 ,203 900ul.A.Guslarot.1a 02/329 8 130 Skopje

www.electrolux.com.mk www.elektroluks.com.mk electrolux@mt.net.mk

Electrolux is registered trademark of **Електролюкс** companies in Macedonia and other countries



Contents

Element specifications	Types of termination	1
	Minimum Bend Radii	1
	Mounting Bushes	1
Tubular Elements	Typical tubular element forms	2
Straight Length Tubular Elements with terminals	Water Immersion	3
	Air heaters	3
	Air/Oil heaters	3
Straight Length Tubular Elements with bushes and terminals	Oil and Water Immersion with brazed brass bushes (code B)..	4
	Water and Oil Immersion	4
	Air heating elements with staked steel bushes.....	4
Screw-in Immersion Heaters	Illustration	5
	2" BSP Screw-In Type	6
	2" BSP Incoloy Sheath - Triple Element	6
	Optional Extras	6
Electrical Connections	Triple Elements, Single and Dual Element Types (ilust.).....	7
	Formula to calculate series wattage	7
	Single Phase Type - Water Immersion Elements	7
Water Immersion Elements (1 1/4" BSP Screw-in type)	1 1/4 " Incoloy Sheath - Single and Double Loop	8
	Incoloy Sheath - Dual Elements	8
Oil Immersion Elements (Screw-in type)	1 1/2" BSP Series	8
	1 1/2" BSP Brass Lock Nut	8
Flanged Immersion Heaters	Typical Applications	9
	Versatility	9-10
	Flange Data	11
	Optional Enclosure	11
	Incoloy 800 Sheath - 31 kW/m ² (20w/in ²)	12
	Incoloy 800 Sheath - 77 kW/m ² (20w/in ²)	12
Plating Solution Immersion Heaters (Over-the-side type)	Applications	13
	Features	13
	Catalogue	13
	Metal Sheathed	14
	Additional available features	14
	Quick Calculation Chart for heat requirements	14
Withdrawable Tubular Heaters	50mm (2") diameter Immersion Series	15
	Catalogue	16
	Screw-in Heater Jacket: 2" BSP series	17
	General Applications	17
	Optional Terminal Cover Assembly	17
	Flanged Heater Jackets	18
	General Applications (Flanged Heater Jackets)	18
	Multiple Jacket Flanged Immersion Heater (custom built)	18
Air Heating	Unfinned - Incoloy Sheath (46.5 kW Series)	19
	Unfinned - Incoloy Sheath (31 kW Series)	19
	Finned Tubular (46.5 kW Series)	20
	Finned Tubular (93 kW Series)	20
	Finned Tubular 11mm "Multi Form"(46.5 kW Series)	21
	Finned Tubular 11mm "Multi Form"(93 kW Series)	21
	Straight Length - Finned Tubular (46.5 kW Series)	21
	Straight Length - Finned Tubular (96 kW Series)	21
	Finned Tubular 8mm (31 kW Series)	22
	Finned Tubular 8mm (108 kW Series)	22
	Terminal Boxes	23
	Duct Heater Selection Tables	24
	Finned Tubing data	25
Radiant Infra-red Heaters (Ceramic)	Why Infra-red?	26
	Application Data	27
	Half Trough Elements	28
	Full Trough Elements	28
	Polished Stainless Steel Reflectors	28
	Fixing Arrangements	29
	Physical dimensions	29
	Spectral Graphs	29
	Edison Screw Elements	30
	Optional Parts	31



Radiant Infra-red Heaters (Metal Sheathed)	General Applications	32
	Applications	32
Drum Heaters	Base heater	33
	Metal Band Drum heater	33
Inline Water Heaters	General Information	34
	Sizes available	34
Cubicle Heating Elements	Straight Form	35
	"U" Form	35
Controls	General Information	36
	Wiring Installation	37
	Thermostat installation	38
	Control Thermostat (Liquid Expansion)	39
	Control Thermostat (Weatherproof Series)	39
	Control Thermostat (External Calibrated Dial Series)	39
	Thermostat Bulb Pocket	39
	RKC (RIKA Electronic Controls)	40
	Thermocouples	40
	Manual Reset (capillary type)	41
	Auto Reset (contact type)	41
	Fan/Heat Sequencer & Time Delay	41
Custom Built Products	General Information	42
Flame Proof Heaters	General Information	43
Technical Section	Specific heats and constants	44
	Suggested maximum watts density ratings	45
	Ohm's Law	45
	Conversion Factors	46

Desing Electrolux Macedonia
www.electroluxdesignlab.mk



ELEMENT SPECIFICATIONS

Types of termination

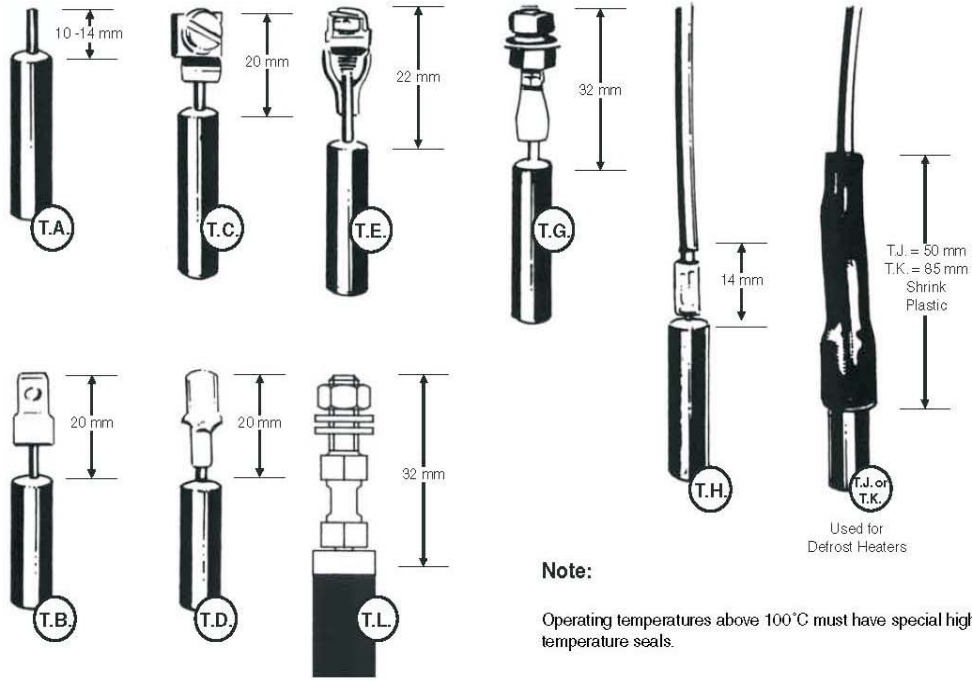

Note:
Operating temperatures above 100°C must have special high temperature seals.

Minimum Bend Radii

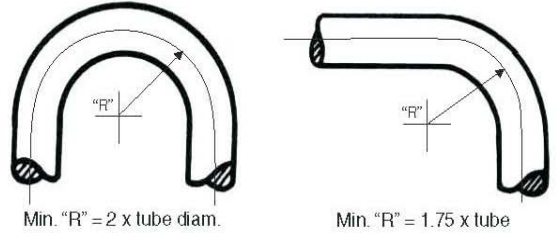

Gaskets and lock nuts are supplied with all mounting bushes. Special mounting bushes can be made to customer's requirements.
In addition special mount plates, mounting heads, supports, brackets etc. can be supplied to order.

Sheath Material	Maximum Allowable Sheath Temperature	Normal Weld Density Watts/cm ² (in ²)
Copper	180°C (350°F)	approx. 7 - 15 (50-100)
Steel	400°C (750°F)	approx. 3 (20)
Stainless Steel	650°C (1200°F)	approx. 3 - 6 (20-40)
Incoloy	815°C (1500°F)	approx. 4.5 - 6 (30-40)
Inconel	925°C (1700°F)	approx. 4.5 - 6 (30-40)

Mounting Bushes

Brass weld on mounting bushes for tank immersion heaters. Steel press on mounting bushes for air heaters.

3/8" B.S.P. thread length dim. "T"
10 mm
16 mm
32 mm
38 mm

3/8" B.S.P. thread length dim. "T"
13 mm

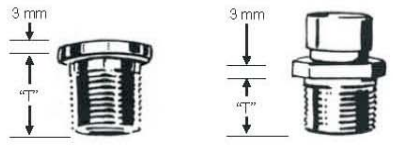

Maximum Available Dimensions mm			
Finished Sheath Dia.	Finished Sheath Lengths		
	Copper	Steel	Incoloy and Stainless Steel
6.3	7507	7612	7137
6.6	-	6705	6629
8.0	6731	6629	6500
8.1	6541	6451	6350
10.3	6883	7050	6828
11.2	6172	6100	6128

Elektroluks is registered trademark of Elektroluks companies in Macedonia and other countries



Ovo je crtez e sposobnost na Elektroluks-Strida.Bez negovo pismeno odobruvanje istiot nesmee da se precisira, umozuva ili kopira bez soglasnost od **Elektroluks** vo spratno se snoset posledici vo smislana celovite 163 i 164 od kriticniot zakon R.M. (povreda na autorsko pravo)

Tubular Elements

Typical Tubular Element Forms

Palenzo tubular elements can be formed into nearly any configuration. The following forms can be used as a guide to determining the best element shape for a given application.

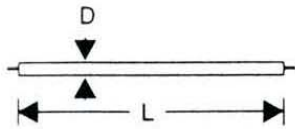

Fig. 1

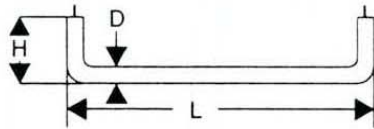

Fig. 2

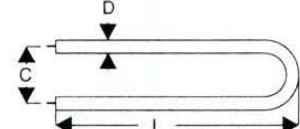

Fig. 3

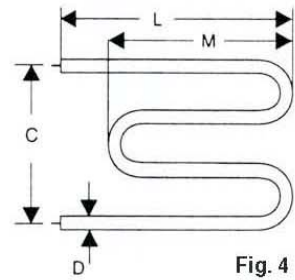

Fig. 4

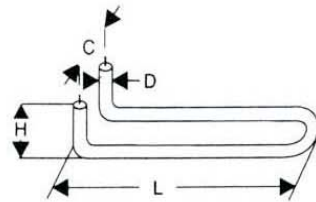

Fig. 5

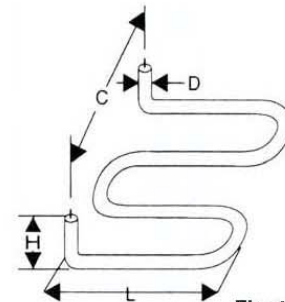

Fig. 6

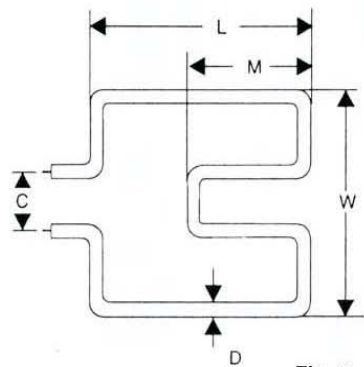

Fig. 7

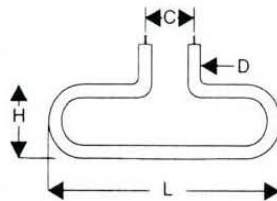

Fig. 8

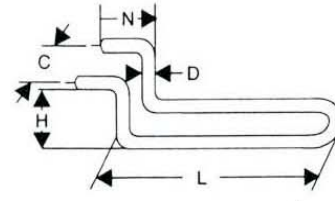

Fig. 9

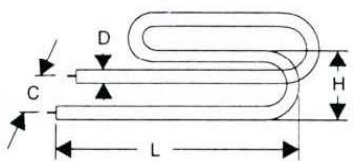

Fig. 10

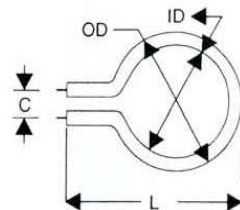

Fig. 11

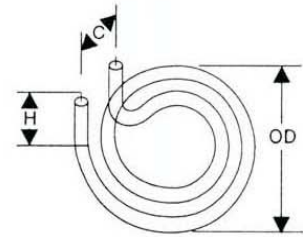

Fig. 12

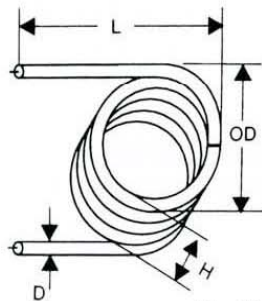

Fig. 13

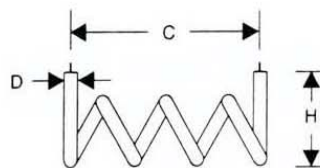

Fig. 14

Straight Length Tubular Elements with Terminals

Oil, Water and Air Immersion

Electrolux-Palenzo Straight Length Tubular elements are available in two sheath materials. Incoloy sheath for oil immersion, copper sheath for water and incoloy for air heating. They can be formed to suit the heating pattern that you require.

Note: Special wattages, lengths and diameters can be made to suit the customer's requirements.

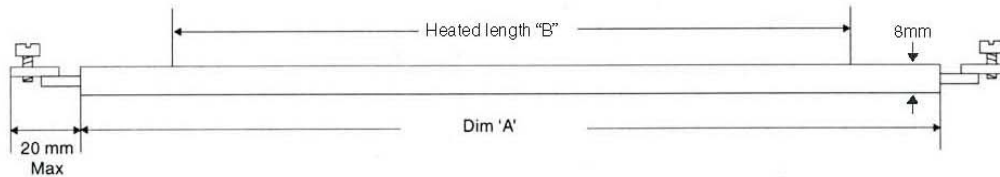

Water Immersion

Copper Sheath/Incoloy Sheath (120 kW/sq.m)					
Cat. No. Copper Sheath (120 kW/sq.m)	Cat. No. Incoloy Sheath (120 kW/sq.m)	Watts	Volts	Dim "A"	Heated Length "B"
2231-15	2221-15	600	240	285	200
2232-15	2222-15	800	240	385	305
2233-15	2223-15	1200	240	485	405
2234-15	2224-15	1500	240	585	505
2235-15	2225-15	1800	240	685	605
2236-15	2226-15	2000	240	755	675
2237-15	2227-15	2400	240	890	810
2238-15	2228-15	3000	240	1090	960
2239-15	2229-15	3600	240	1290	1150
2240-15	2230-15	4800	240	1690	1550

Incoloy Sheath (77 kW/sq.m)				
Cat. No.	Watts	Volts	Dim "A"	Heated Length "B"
2380-15	600	240	436	305
2381-15	800	240	586	458
2382-15	1200	240	736	605
2383-15	1500	240	883	757
2384-15	1800	240	1036	900
2385-15	2000	240	1139	1010
2386-15	2400	240	1339	1210
2387-15	3000	240	1642	1515
2388-15	3600	240	1944	1870
2389-15	4800	240	2549	2425

Air Heaters

Incoloy Sheath (46.5 kW/sq.m)					
Cat. No.	Watts	Volts	Dim "A"	Heated Length "B"	
INC 800	S/Steel				
2201-15	3951-15	500	240	495	345
2202-15	3952-15	750	240	715	560
2203-15	3953-15	1000	240	915	760
2204-15	3954-15	1250	240	1135	985
2205-15	3955-15	1500	240	1335	1185
2206-15	3956-15	1800	240	1595	1445
2207-15	3957-15	2000	240	1775	1620
2208-15	3958-15	2500	240	2195	2050
2209-15	3959-15	3000	240	2615	2470
2210-15	3960-15	4000	240	3742	3576

Air/Oil Heaters

Incoloy Sheath (31 kW/sq.m)					
Cat. No.	Watts	Volts	Dim "A"	Heated Length "B"	
INC 800	S/STEEL				
2211-15	3971-15	500	240	715	560
2212-15	3972-15	800	240	1035	880
2213-15	3973-15	1000	240	1335	1185
2214-15	3974-15	1250	240	1675	1530
2215-15	3975-15	1500	240	1975	1830
2216-15	3976-15	1800	240	2355	2215
2217-15	3977-15	2000	240	2625	2470
2218-15	3978-15	2500	240	3255	3115

Elektroluks is registered trademark of Elektroluks companies in Macedonia and other countries



Ovoj crtez e sposobnost na ElectroLux-Prod.Bez negovo pisarno odobruvanje istoi nesmee da se precisira, umozuva ili kopira bez soglasnost od ElektroLux. Vo spratno se srusot posedici vo smislana clenovi 163 i 164 od klicniot zakon R.M. (povreda na avtorsko pravo)

Straight Length Tubular Elements with Bushes and Terminals

Oil and Water Immersion with brazed brass bushes (Code B)

Electrolux-Palenzo Straight Length elements come complete with standard 3/8" BSP bushes, 16.25mm length in brass for immersion heating and stake-on type plated steel for air heating. Straight Length Elements can be formed to suit the heat pattern required. **Note:** special wattages, lengths, diameters and bushes can be supplied on request.

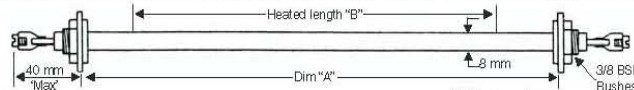

Water Immersion

Incoloy Sheath (46.5 kw/sq.m)					
Cat.No.	Watts	Volts	Dim "A"	Heated Length "B"	
2201-10 B	500	240	455	345	
2202-10 B	750	240	675	560	
2203-10 B	1000	240	875	760	
2204-10 B	1250	240	1095	985	
2205-10 B	1500	240	1295	1185	
2206-10 B	1800	240	1555	1445	
2207-10 B	2000	240	1735	1620	
2208-10 B	2500	240	2155	2050	
2209-10 B	3000	240	2575	2470	
2210-10 B	4000	240	3676	3576	

Water Immersion

Incoloy Sheath (77 kw/sq.m)					
Cat. No.	Watts	Volts	Dim "A"	Heated Length "B"	
2380-10 B	600	240	405	305	
2381-10 B	800	240	565	455	
2382-10 B	1200	240	715	605	
2383-10 B	1500	240	863	757	
2384-10 B	1800	240	1015	910	
2385-10 B	2000	240	1120	1010	
2386-10 B	2400	240	1320	1210	
2387-10 B	3000	240	1620	1515	
2388-10 B	3600	240	1925	1820	
2389-10 B	4800	240	2350	2425	

Water Immersion

Incoloy Sheath (120kw/sq.M)					
Cat. No. Copper Sheath (120kW/sq.m)	Cat. No. Incol. Sheath (120kW/sq.m)	Watts	Volts	Dim "A"	Heated Length 'B'
2231-10 B	2221-10 B	600	240	245	200
2232-10 B	2222-10 B	900	240	345	305
2233-10 B	2223-10 B	1200	240	445	405
2234-10 B	2224-10 B	1500	240	555	505
2235-10 B	2225-10 B	1800	240	645	605
2236-10 B	2226-10 B	2000	240	715	675
2237-10 B	2227-10 B	2400	240	850	810
2238-10 B	2228-10 B	3000	240	1048	960
2239-10 B	2229-10 B	3600	240	1250	1150
2240-10 B	2230-10 B	4800	240	1650	1550

Oil Immersion

Incoloy Sheath (31kw/sq.m)					
Cat.No.	Watts	Volts	Dim "A"	Heated Length "B"	
2211-10 B	500	240	675	560	
2212-10 B	800	240	995	880	
2213-10 B	1000	240	1295	1185	
2214-10 B	1250	240	1635	1530	
2215-10 B	1500	240	1935	1830	
2216-10 B	1800	240	2315	2215	
2217-10 B	2000	240	2575	2470	
2218-10 B	2500	240	3215	3115	

Air Heating Elements with staked steel bushes (Code M)

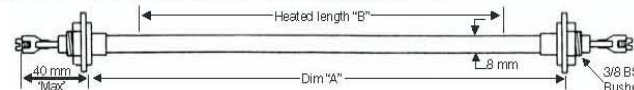

Air Heaters

Incoloy Sheath (46.5 kw/sq.m)					
Cat. No.	Watts	Volts	Dim "A"	Heated length "B"	
2201-10 M	500	240	455	345	
2202-10 M	750	240	675	560	
2203-10 M	1000	240	875	760	
2204-10 M	1250	240	1095	985	
2205-10 M	1500	240	1295	1185	
2206-10 M	1800	240	1555	1445	
2207-10 M	2000	240	1735	1620	
2208-10 M	2500	240	2155	2050	
2209-10 M	3000	240	2575	2470	
2210-10 M	4000	240	3476	3368	

Incoloy Sheath (31kw/sq.m)					
Cat.No.	Watts	Volts	Dim "A"	Heated Length "B"	
2211-10 M	550	240	675	560	
2212-10 M	800	240	995	880	
2213-10 M	1000	240	1295	1185	
2214-10 M	1250	240	1635	1530	
2215-10 M	1500	240	1935	1830	
2216-10 M	1800	240	2315	2215	
2217-10 M	2000	240	2575	2470	
2218-10 M	2500	240	3215	3115	

Desing Electrolux Macedonia
www.electroluxdesignlab.mk

+38947/203-330 ,203 900+389 2/329 8 130 www.electrolux.com.mk www.elektroluks.com.mk- electrolux@mt.net.mk



Elektroluks is registered trademark of ElektroLux companies in Macedonia and other countries

Ovoj crtez e sopstvenost na Electrolux-Bitola.Bez negovo pisмено oobavuvanje istoi nesmee da se prepisuva ,umnozuvaa ili kopira bez soglasnost od **Elektroluks** vo sprotno se snoset posledeci vo smislana clanova 163 i 164 od klicniot zakon R.M. (povreda na avtorsko pravo)

Screw-In

Screw-in Immersion Heaters



Desing Electrolux Macedonia
www.electroluxdesignlab.mk

+38947/203-330 ,203 900+389 2/329 8 130 www.electrolux.com.mk www.elektroluks.com.mk electrolux@mt.net.mk



Elektroluks is registered trademark of Elektroluks companies in Macedonia and other countries

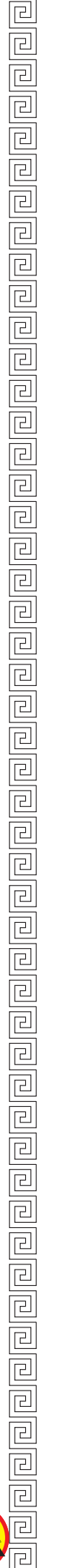

Triple Immersion Elements

2" BSP Screw-In Type

Element Unit with Thermostat Pocket

Electrolux-Palenzo range of Screw-In Immersion elements have been designed to allow a greater level of flexibility through the introduction of a triple element assembly.

All elements are supplied with a fibre sealing gasket. Terminal covers and built in thermostats can be supplied if required.

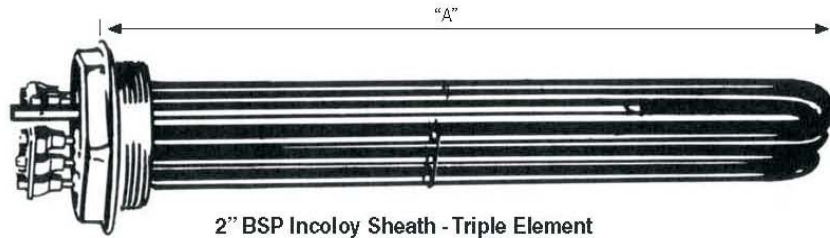

2" BSP Incoloy Sheath - Triple Element

Incoloy Sheath - Triple Element			
Cat.No.	Watts (20 W/in ²) (31kW/m ²)	Dim'A'	Applications
2620	1500W	364mm	
2621	2400W	523mm	OIL
2622	3000W	675mm	HEATING
2623	3750W	847mm	
2624	4500W	997mm	ALKALINE
2625	5400W	1189mm	CLEANING
2626	6000W	1320mm	SOLUTIONS
2627	7500W	1640mm	
Cat.No.	Watts (50W/in ²) (77.5kW/m ²)	Dim'A'	Applications
2630	1800W	221mm	
2631	2400W	297mm	
2632	3600W	372mm	
2633	4500W	447mm	
2634	5400W	522mm	WATER
2635	6000W	574mm	
2636	7200W	675mm	HEATING
2637	9000W	827mm	
2638	10.8KW	974mm	
2639	14.4KW	1282mm	
Cat.No.	Watts (75W/in ²) (116 kW/m ²)	Dim'A'	Applications
2640	1800W	144mm	
2641	2400W	195mm	
2642	3600W	246mm	
2643	4500W	296mm	
2644	5400W	346mm	WATER
264	6000W	380mm	
2646	7200W	448mm	HEATING
2647	9000W	553mm	
2648	10.8KW	643mm	
2649	14.4KW	845mm	

Optional Terminal Covers

Cat No: 2620-09 (PVC)

Cat No: 2220 (Aluminium)

Cat No. 2620-14

(Powder coated)

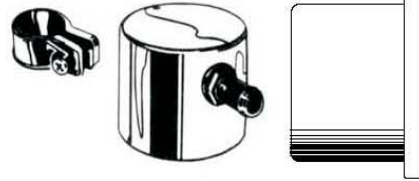

Built-in Thermostat

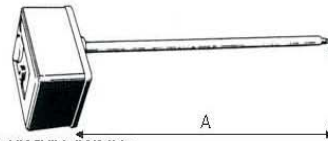

Temperature range:

0 to 80 °C

0 to 100 °C

Cat. No. TE/7 (Dim A: 178 mm)

Cat. No. TED (Dim A: 280 mm)

Single Pole Thermostat

20 Amp rating 4800 Watts (max.)

2" BSP Brass Lock Nuts

Cat. No. 2221-22



Electrical Connections

Triple Elements

Three Phase

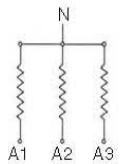

240 : 415 Volt
Star Connection

Single Phase

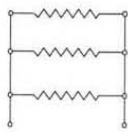

240 Volt
Parallel Connection

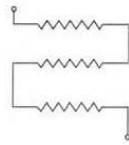

240 Volt
Series Connection

Dual Element

Single Phase

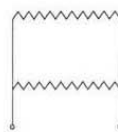

240 Volt
1200 W
Parallel Connection

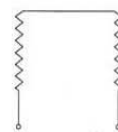

240 Volt
300 W
Series Connection

Formula to calculate series wattage:

$$(a) 3 \text{ elements} = \frac{\text{rated watts}}{9} = \frac{\text{new}}{\text{total watts}}$$

$$(b) 2 \text{ elements} = \frac{\text{rated watts}}{4} = \frac{\text{new}}{\text{total watts}}$$

Single Phase Type

Water Immersion Elements (2" BSP Screw-in type)

2" Incoloy Sheath-Single and Double Loop (120 kW/sq.m.)

Cat No.	Watts	Volts	A'mm
2221-200 SL	600	240	145
2222-200 SL	800	240	200
2223-200 SL	1200	240	250
2224-200 DL	1500	240	180
2225-200 DL	1800	240	200
2226-200 DL	2000	240	220
2227-200 DL	2400	240	250
2228-200 DL	3000	240	300
2229-200 DL	3600	240	355
2230-200 DL	4800	240	455

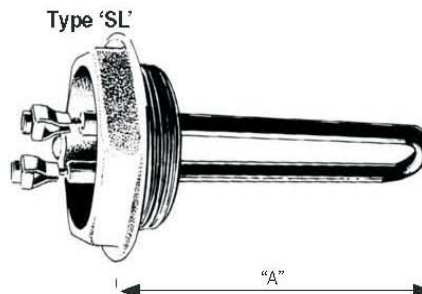
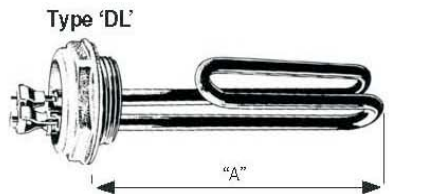

Incoloy Sheath-Dual Elements (120kw/sq.m and 31kw/sq.m)

Cat No.	120kw/sq.m	31kw/sq.m	Volts	A'mm
2261-200	1200	300	240	145
2262-200	1600	400	240	200
2263-200	2400	600	240	250
2264-200	3000	750	240	300
2265-200	3600	900	240	350
2266-200	4000	1000	240	385
2267-200	4800	1200	240	450
2268-200	6000	1500	240	550
2269-200	7200	1800	240	655
2270-200	9600	2400	240	855

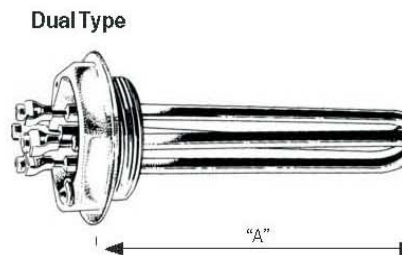

Ovo je crtez e sposobnost na Elektroluks-Bez. negovo pismeno odobruvanje istov nesree da se precisno umozuva niti kopira bez soglasnost od Elektroluks vo sprotno se snosot posedici vo smislana clanova 163 i 164 od kivilniot zakon R.M. (povreda na avtorsko pravo)

Elektroluks is registered trademark of Elektroluks companies in Macedonia and other countries



Water Immersion Elements (1 1/4" BSP Screw-in type)

Electrolux-Palenzo 1 1/4" BSP Screw-in type Immersion elements are available in single loop, double loop and dual elements (2) forms. Special voltages and wattages are available on request. All elements are supplied with a fibre sealing gasket. Optional terminal cover complete with a 16mm flexible conduit adaptor is available on request.

1 1/4" Incoloy Sheath - Single and Double Loop

Cat. No.	Watts	Volts	A'mm
2221-125	600	240	150
2222-125	800	240	200
2223-125	1200	240	250
2224-125	1500	240	180
2225-125	1800	240	200
2226-125	2000	240	220
2227-125	2400	240	255
2228-125	3000	240	305
2229-125	3600	240	355
2230-125	4800	240	455

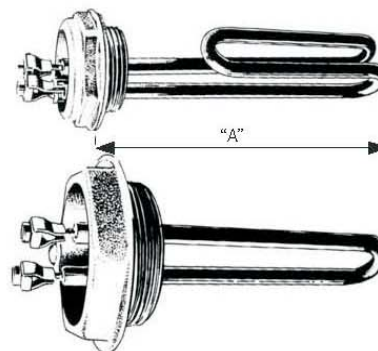

Incoloy Sheath - Dual Elements (120 kW/sq.m and 31 kW/sq.m)

Cat. No.	120kw/sq.m	31kw/sq.m	Volts	A'mm
2261-125	1200	900	240	150
2262-125	1600	450	240	200
2263-125	2400	600	240	250
2264-125	3000	750	240	300
2265-125	3600	900	240	350
2266-125	4000	1000	240	385
2267-125	4800	1200	240	455
2268-125	6000	1500	240	550
2269-125	7200	1800	240	655
2270-125	9600	2400	240	855

Sheath ratings (120kW/sq.m and 31kW/sq.m)

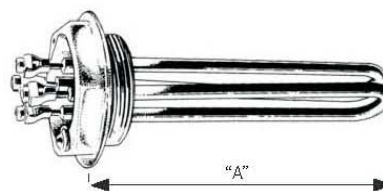

Oil Immersion Elements (Screw-in type)

Electrolux-Palenzo 1 1/4" Oil heating Elements are designed with various sheath ratings to suit most grades of oil and alkaline cleaning solutions. Special voltages and wattages are available on request. Heaters are supplied with a sealing gasket. Optional terminal cover complete with a 16mm flexible conduit adaptor.

1 1/4" BSP Series

Incoloy/Sheath - Dual Element (Sheath Ratings: 31kW/sq.m & 7.75kW/sq.m)

Cat.No.	31kw/sq.m	7.75kw/sq.m	Volts	A'mm
2251-125	1000	250	240	380
2252-125	1600	375	240	535
2253-125	2000	500	240	700
2254-125	2500	625	240	860
2255-125	3000	750	240	1025
2256-125	3600	900	240	1215
2257-125	4000	1000	240	1345
2258-125	5000	1250	240	1665

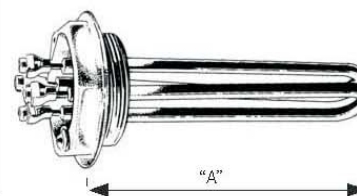

1 1/4" BSP Brass Lock Nut

Cat.No. 2221-21



Spun Aluminium Terminal Cover

Cat.No. 2219

Flanged Immersion Heaters (data sheet)

Application:

Palenzo manufacture a wide range of flanged immersion heaters designed to heat liquids or gases in tanks or inline vessels. Suitable for, Water, Oil, Resins, Food products and many other liquids and gases.

General Construction:

Our standard range of immersion heaters, consists of a number of robust hairpin elements welded/soldered or fitted by using compression fittings to a blind pipe flange. All units are balanced over 3 phase in multiple groups of 3 elements, and can be terminated in an optional protective terminal enclosure. All units are hydrostatically tested for leaks prior to shipment.

Versatility:

This style of immersion heater allows for simple, low cost installation, and generates 100% efficiency as direct heating into the solution. Our construction method, also achieves minimum resistance to the circulation of solutions to be heated.

Installation:

Since the flanged heaters are constructed using standard pipe flanges, they are easily installed by using matching companion fittings that are mounted to the tank or vessels. Therefore a wide range of mounting applications are available such as, vats, tanks, pipes or irregular shaped vessels.

Control:

All flanged heaters have provision for control and safety thermostats with sensing probes into protective thermo wells mounted to the heater assembly. Complete control systems are available on request.

Selection:

It is extremely important that our engineers have a full description of the application to enable correct design of the flanged heater, as the design will be influenced by the following:

1. Heat characteristics of the product to be heated (i.e. solution concentration and operating temperatures).
2. Corrosive nature of product to be heated.
3. Flowrate and process heat up time requirement.
4. Power supply available for heater
5. Insulation of recipient containing the solution



Desing Electrolux Macedonia

www.electroluxdesignlab.mk



Flanged Immersion Heaters

Electrolux-Palenzo offer a comprehensive range of Flanged Immersion Heaters designed to solve many industrial heating problems.

Typical Applications

Water heating, fuel, oils, resins, solvent and degreasing solutions, machine and heat transfer oils etc.

Versatility

Flanged type heaters allow for simple, low cost installation. They provide 100% heating efficiency whilst providing minimum resistance to allow free flow and circulation.

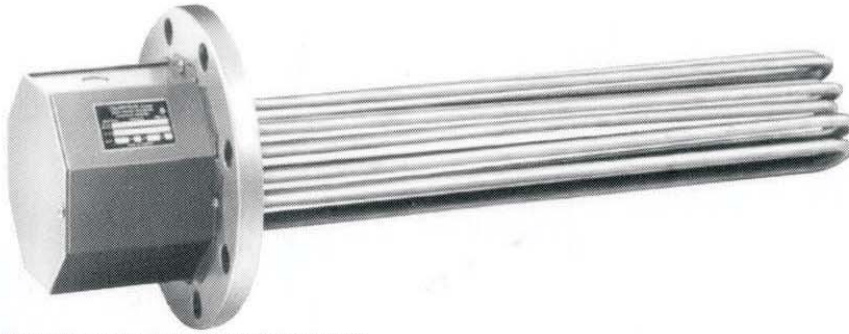

Flanged Immersion Heater using tubular elements



Flanged Immersion Heater using withdrawable elements

Special Applications

Flameproof Flanged Immersion Heaters are available on request. Please contact Electrolux for more details.

Desing Electrolux Macedonia

www.electroluxdesignlab.mk

+38947/203-330 ,203 900+389 2/329 8 130 www.electrolux.com.mk www.elektroluks.com.mk electrolux@mt.net.mk



Elektroluks is registered trademark of Elektroluks companies in Macedonia and other countries

Ovoj crtez e sposobnost na Electrolux-Bitola.Bez negovo pismeno odobruvanje istoi nestree da se precisira, umnozava ili kopira bez soglasnost od **Elektrolux** vo sprotno se snoset posledici vo smislana clenova 163 i 164 od klicniot zakon R.M. (povreda na autorsko pravo)

Flanged Immersion Heaters

Ordering Data: quote catalogue number, watts, volts and application. Please indicate any special features that are required (i.e. 2712-36 = 54kW 415/240V)

Incoloy 800 Sheath

Average watts density over sheath area - 31 kW/m² (20w/in²)

Voltage		Flange Bore Size							
415/240 Volt Star Connected	415 Volt Delta Connected	80mm	125mm	150mm	200mm	250mm	300mm	350mm	
Cat.No.	Cat.No.	-3	-6	-12	-18	-27	-36	-45	Dim"A"
2711	2731	9KW	6KW	12KW	18KW	27KW	36KW	45KW	554mm
2712	2732	4.5KW	9KW	18KW	27KW	40.5KW	54KW	67.5KW	784mm
2713	2733	6KW	12KW	24KW	36KW	54KW	72KW	90KW	1014mm
2714	2734	7.5KW	15KW	30KW	45KW	67.5KW	90KW	112.4KW	1243mm
2715	2735	9KW	18KW	36KW	54KW	81KW	108KW	135KW	1473mm
2716	2736	10.5KW	21KW	42KW	63KW	94.5KW	126KW	157.5KW	1703mm
2717	2737	12KW	24KW	48KW	72KW	108KW	144KW	180KW	1932mm
2718	2738	15KW	30KW	60KW	90KW	135KW	180KW	225KW	2392mm

Incoloy 800 Sheath

Average watts density over sheath area - 77.5 kW/m² (50w/in²)

Voltage		Flange Bore Size							
415/240 Volt Star Connected	415 Volt Delta Connected	80mm	125mm	150mm	200mm	250mm	300mm	350mm	
Cat.No.	Cat.No.	-3	-6	-12	-18	-27	-36	-45	Dim"A"
2720	2740	6KW	12KW	24KW	36KW	54KW	72KW	90KW	462mm
2721	2741	7.5KW	15KW	30KW	45KW	67.5KW	90KW	112.5KW	554mm
2722	2742	9KW	18KW	36KW	54KW	81KW	108KW	135KW	646mm
2723	2743	10.5KW	21KW	42KW	63KW	94.5KW	126KW	157.5KW	738mm
2724	2744	12KW	24KW	48KW	72KW	108KW	144KW	180KW	830mm
2725	2745	13.5KW	27KW	54KW	81KW	121.5KW	162KW	202.5KW	922mm
2726	2746	15KW	30KW	60KW	90KW	135KW	180KW	225KW	1014mm
2727	2747	16.5KW	33KW	66KW	99KW	148.5KW	198KW	247.5KW	1106mm
2728	2748	18KW	36KW	72KW	108KW	162KW	216KW	270KW	1197mm
2729	2749	19.5KW	39KW	78KW	117KW	175.5KW	234KW	292.5KW	1289mm
2730	2750	21KW	42KW	84KW	126KW	189KW	252KW	315KW	1357mm
	2751	24KW	48KW	96KW	144KW	216KW	288KW	360KW	1565mm
	2752	27KW	54KW	108KW	162KW	243KW	324KW	405KW	1749mm
	2753	30KW	60KW	120KW	180KW	270KW	360KW	450KW	1932mm

*Note: Terminal Covers are an optional extra

Special Ratings:

Variations in wattage and voltage can be supplied (within practical limits). Contact **Electrolux** for more details.

Corrosion Policy:

Palenzo can not warrant any electrical immersion heater against failure by sheath corrosion if such failure is the result of operating conditions beyond the control of the heater design. It is the responsibility of the purchaser to make the final choice of sheath material based on their knowledge of chemical composition of the corrosive solution to be used.

Desing Electrolux Macedonia

www.electroluxdesignlab.mk

+38947/203-330 ,203 900+389 2/329 8 130 www.electrolux.com.mk www.elektroluks.com.mk electrolux@mt.net.mk



Plating Solution Immersion Heaters (Over-the-side type)

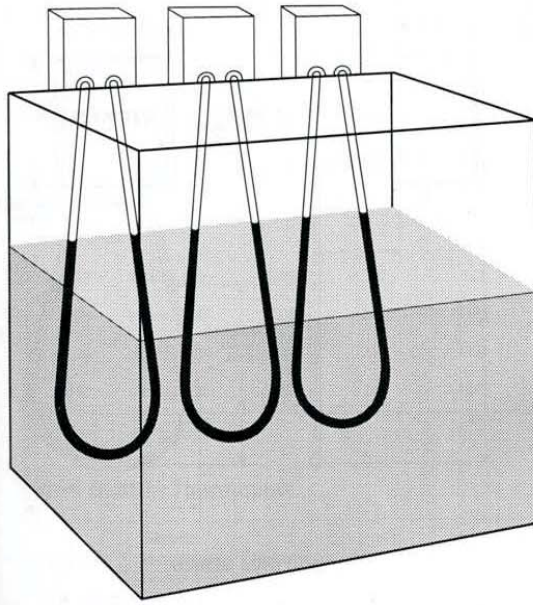

Applications:

- Chemical Tanks
- Plating Vats
- Washing Baths
- Frost protection
- General Purpose Heaters

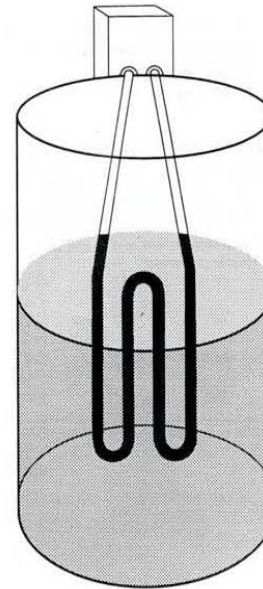

Features:

- No expensive installation costs
- Compact
- Convenient to use
- Clean in operation
- Easily moved from one tank to another

Standard Heater Cat. No.	Built in Thermostat Cat No.	Sheath Material	Wattage	Volts	Application	Dimensions in mm			
						A	B	C	D
2290	2390	Incoloy 800	1000	240	SOLUTIONS NOT CORROSIVE TO INCOLOY 800	U Form			
2291	2391	incloy 800	2000	240		518	950	110	160
2292	2392	incloy 800	3000	240		852	680	110	160
2293	2393	incloy 800	4000	240		W Form			
2294	2394	incloy 800	5000	240		987	550	110	190
2295	2395	incloy 800	6000	240		1153	720	110	190
						1320	890	110	190
					1487	1050	110	190	

Ordering data: quote catalogue number (delivery ex stock 1-3 weeks)

Tolerance on dimension A ± 10 mm

Note: refer to page 14 for the method for calculating the required wattage.

Corrosion Policy:

Palenzo can not warrant any electrical immersion heater against failure by sheath corrosion if such failure is the result of operating conditions beyond the control of the heater design. It is the responsibility of the purchaser to make the final choice of sheath material based on their knowledge of chemical composition of the corrosive solution to be used.

Desing Electrolux Macedonia

www.electroluxdesignlab.mk

+38947/203-330 ,203 900+389 2/329 8 130 www.electrolux.com.mk www.elektroluks.com.mk - electrolux@mt.net.mk



Plating Solution Immersion Heaters (Over-the-side type)

Metal Sheathed

Stokes Synertec's Over-the-side immersion heaters provide an easy means of heating solutions in tanks.

- Installation costs are significantly reduced due to heaters being hung over the side of tanks.
- Standard heaters are available ex-stock in the range listed.
- Special shape modifications can be manufactured to suit shallow tanks and specific user requirements.
- Terminations are enclosed in a moisture-proof P.V.C. box.

Additional features:

- Built in Control Thermostat 20°C to 120°C scale range (15 amp rating).
- Special voltage or wattage.
- Special bending configurations.
- Different sheath materials (contact Stokes Synertec).

Orders & enquiries:

- When ordering please state the solutions to be heated, working temperature and minimum liquid level.
- State dimensions and shape of heater preferred.

"U" Form Series

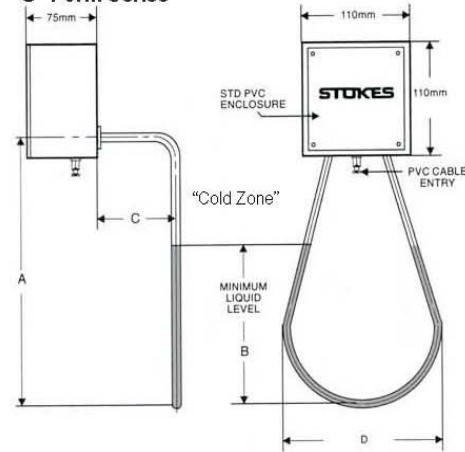

"W" Form Series

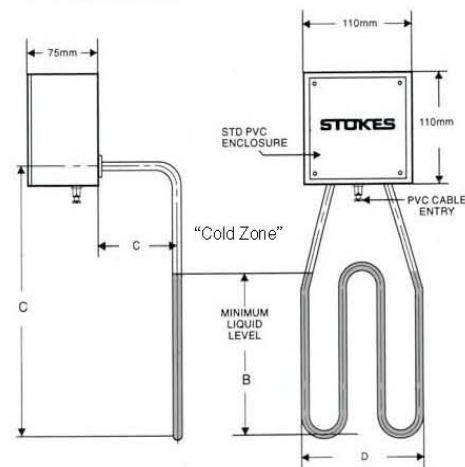

Quick Calculation Chart for heat requirements

Tank Capacity		Operating Temperature										
		Fahr. 100°	110°	120°	130°	140°	150°	160°	170°	180°	190°	200°
Gallons	Litres	Cent. 39°	43°	49°	55°	60°	65°	71°	77°	82°	88°	93°
50	227	kW 0.5	kW 0.75	kW 1	kW 1.5	kW 1.5	kW 2	kW 2	kW 2	kW 3	kW 3	kW 3
75	341	kW 1	kW 1	kW 1.5	kW 1.5	kW 2	kW 2	kW 3	kW 3	kW 3	kW 4	kW 4
100	455	kW 1.5	kW 1.5	kW 2	kW 3	kW 3	kW 3	kW 4	kW 4	kW 4	kW 5	kW 5
125	568	kW 1.5	kW 2	kW 3	kW 3	kW 4	kW 4	kW 4	kW 5	kW 5	kW 5	kW 6
150	682	kW 2	kW 2	kW 3	kW 3	kW 4	kW 4	kW 5	kW 5	kW 6	kW 6	kW 7
175	796	kW 3	kW 3	kW 4	kW 4	kW 5	kW 5	kW 5	kW 6	kW 6	kW 7	kW 7
200	910	kW 3	kW 3	kW 4	kW 4	kW 5	kW 5	kW 6	kW 6	kW 7	kW 8	kW 9
250	1137	kW 3	kW 4	kW 4	kW 5	kW 5	kW 7	kW 7	kW 8	kW 9	kW 10	kW 11
300	1365	kW 4	kW 5	kW 6	kW 6	kW 8	kW 9	kW 10	kW 10	kW 11	kW 11	kW 12
350	1592	kW 5	kW 6	kW 7	kW 8	kW 9	kW 10	kW 11	kW 12	kW 13	kW 14	kW 15
400	1820	kW 6	kW 7	kW 8	kW 9	kW 10	kW 11	kW 12	kW 13	kW 14	kW 16	kW 17
450	2047	kW 6	kW 7	kW 9	kW 10	kW 11	kW 12	kW 14	kW 15	kW 16	kW 18	kW 18
500	2275	kW 7	kW 8	kW 9	kW 11	kW 12	kW 13	kW 15	kW 17	kW 18	kW 20	kW 21

Note:

- These wattages are based on an 8 hour heat-up time with an ambient temperature of 21°C (70°F).
- Kilowatt ratings are calculated on tanks having a 50mm insulation and are enclosed.
- To reduce heat-up time increase the wattage proportionately.

Ovo je crtez e soopštenost na Elektro-luks. Bez negovog pismenog odobruvanja isti crtez ne sme da se precisuje, umnozava ni li kopira bez saglasnosti od Elektro-luks. Uvo spretno se snoset posledici vo smislana clerovitel 63 i 164 od kliciviot zakon R.M. (povreda na avtorsko pravo)

Elektroluks is registered trademark of Elektroluks companies in Macedonia and other countries



Ovoj crtez e sposobnost na Electrolux-Rizid.Bez negovo pisarerno odobruvanje istoi nesmee da se precisira, umnozava nihi kopira bez soglasnost od **Elektroluks** vo sprotno se snosot posedeci vo smislana clenova 163 i 164 od klicniot zakon R.M. (povreda na autorsko pravo)

Plating Solution Immersion Heaters (Over-the-side type)

Metal Sheathed

Electrolux-Palanzo Over-the-side immersion heaters provide an easy means of heating solutions in tanks.

- Installation costs are significantly reduced due to heaters being hung over the side of tanks.
- Standard heaters are available ex-stock in the range listed.
- Special shape modifications can be manufactured to suit shallow tanks and specific user requirements.
- Terminations are enclosed in a moisture-proof P.V.C. box.

Additional features:

- Built in Control Thermostat 20°C to 120°C scale range (15 amp rating).
- Special voltage or wattage.
- Special bending configurations.
- Different sheath materials (contact Stokes Synertec).

Orders & enquiries:

- When ordering please state the solutions to be heated, working temperature and minimum liquid level.
- State dimensions and shape of heater preferred.

“U” Form Series

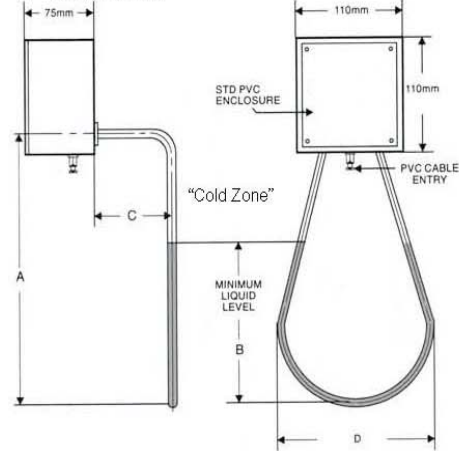

“W” Form Series

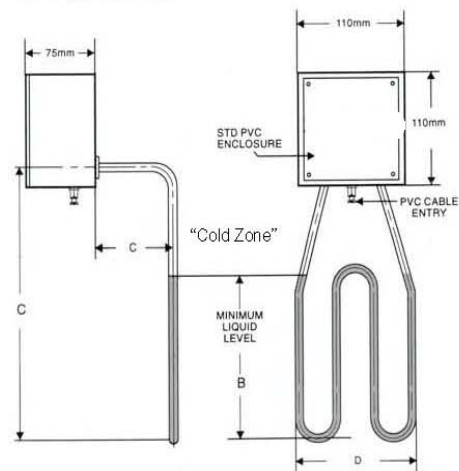

Quick Calculation Chart for heat requirements

Tank Capacity		Operating Temperature											
		Fahr. Cent.	100° 38°	110° 43°	120° 49°	130° 55°	140° 60°	150° 65°	160° 71°	170° 77°	180° 82°	190° 88°	200° 93°
Gallons	Litres	kW	kW	kW	kW	kW	kW	kW	kW	kW	kW	kW	kW
50	227	0.5	0.75	1	1.5	1.5	2	2	2	3	3	3	3
75	341	1	1	1.5	1.5	2	2	3	3	3	4	4	4
100	455	1.5	1.5	2	3	3	3	4	4	4	5	5	5
125	568	1.5	2	3	3	4	4	4	5	5	5	6	6
150	682	2	2	3	3	4	4	5	5	6	6	7	7
175	796	3	3	4	4	5	5	5	6	6	7	7	7
200	910	3	3	4	4	5	5	6	6	7	8	8	9
250	1137	3	4	4	5	5	7	7	8	9	10	11	11
300	1365	4	5	6	6	8	9	10	10	11	11	12	12
350	1592	5	6	7	8	9	10	11	12	13	14	15	15
400	1820	6	7	8	9	10	11	12	13	14	16	17	17
450	2047	6	7	9	10	11	12	14	15	16	18	18	18
500	2275	7	8	9	11	12	13	15	17	18	20	21	21

Note:

- These wattages are based on an 8 hour heat-up time with an ambient temperature of 21°C (70°F).
- Kilowatt ratings are calculated on tanks having a 50mm insulation and are enclosed.
- To reduce heat-up time increase the wattage proportionately.

Elektroluks is registered trademark of Elektroluks companies in Macedonia and other countries

Desing Electrolux Macedonia

www.electroluxdesignlab.mk



Ovaj crtez e sposobnost na Electrolux-Bitola.Bez negovo pisarstvo oobaruvanje istoi nesmee da se precisura, umozuva nihi kopira bez soglasnost od **Elektroluks** vo sprotno se snoset posledici vo smislana clanova 163 i 164 od klicniot zakon R.M. (povreda na avtorsko pravo)

Withdrawable Tubular Heaters

50mm (2") diameter Immersion Series

Palenzo withdrawable heaters are manufactured to industrial design standards and are interchangeable with ceramic bobbin elements.

Applications:

The low watts densities offered make them suitable for heating sensitive materials such as: fuel oil, glue, mineral oil, wax, asphalt tar and many heavy compounds.

Advantages:

The heater assembly can be easily withdrawn from the metal sheathed tube for repairs or replacement, without disturbing the contents of the system. For example hot water tanks would not need to be drained and it would not be necessary to cool a hot oven. Due to the strong yet light construction the heater has a longer operating life than similar products.

Construction:

Up to three incoloy sheathed tubular elements are brazed into a 45mm (1.77") diameter x 5 mm thick mild steel flange. The spacers are 44mm (1 3/4") diameter and never more than 250mm (10") apart. Also included is a pocket to accommodate an over temperature protection device to ensure the heater does not exceed its maximum operating temperature.

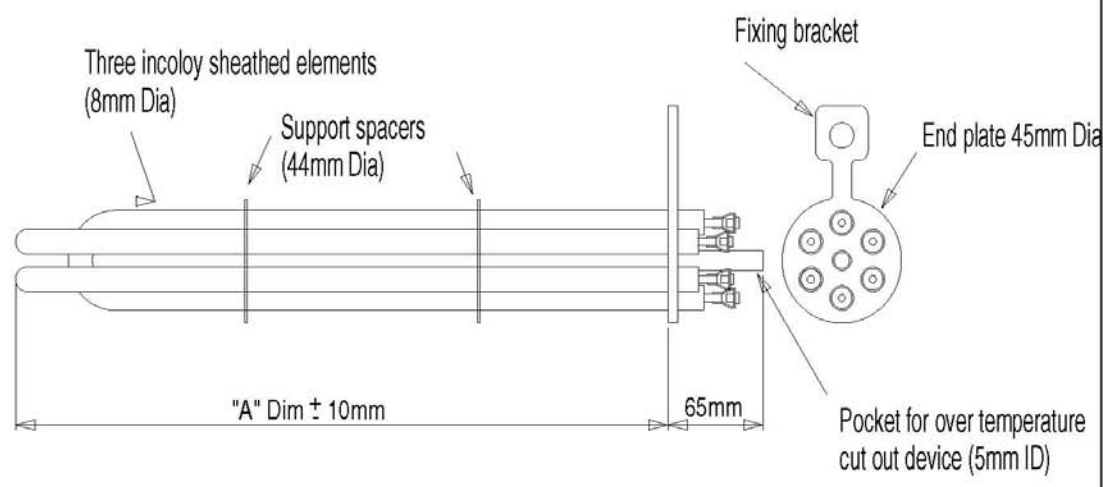

Elektroluks is registered trademark of Elektroluks companies in Macedonia and other countries



Withdrawable Tubular Heaters

Refer to technical section for suggested maximum watts density ratings.

Assembly Cat Number		Heater Watts Density				Heater Length Dim "A"
		6.2 Kw/m ² (4 W/in ²)	12.4 Kw/m ² (8 W/in ²)	18.6 Kw/m ² (12 W/in ²)	31.0 Kw/m ² (20 W/in ²)	
240V	415V					
2665				600W		300mm
2666					750W	300mm
2667			600W			450mm
2668				900W		450mm
2669					1500W	450mm
2670	2770	750W				550mm
2671	2771		1000W			550mm
2672	2772			1500W		550mm
2673	2773				2500W	550mm
2674	2774	1000W				1000mm
2675	2775		2000W			1000mm
2676	2776			3000W		1000mm
2677	2777				5000W	1000mm
2678	2778	1500W				1450mm
2679	2779		3000W			1450mm
2680	2780			4500W		1450mm
2681	2781				7500W	1450mm
2682	2782	2000W				1900mm
2683	2783		4000W			1900mm
2684	2784			6000W		1900mm
2685	2785				10000W	1900mm
2686	2786	2500W				2350mm
2687	2787		5000W			2350mm
2688	2788			7500W		2350mm
2689	2789				12500W	2350mm
2690	2790	3000W				2750mm
2691	2791		6000W			2750mm
2692	2792			9000W		2750mm
2693	2793				15000W	2750mm
2694	2794	3500W				3200mm
2695	2795		7000W			3200mm
2696	2796			10500W		3200mm
2697	2797				17500W	3200mm

Refer to technical section for suggested maximum watts density ratings page 45.

Withdrawable Tubular Heaters

Screw-in Heater Jacket: 2" BSP series

- Copper
- Mild Steel
- Stainless Steel

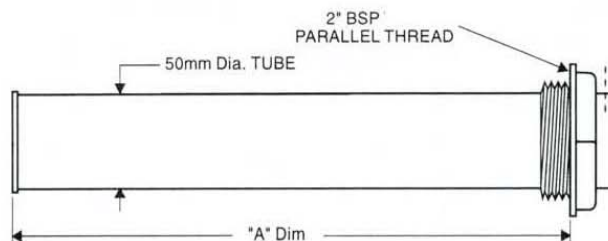

Maximum jacket temperature 400°C (750°F)

Jacket assemblies comprise of 2" BSP brass or stainless steel boss, silver brazed to nominated tube. For customers supplying their own jackets, we recommend 20 or 18 S.W.G. tube, 50mm O.D. Any metal is suitable provided it is free of grease and scale. If a welded tube is used, the welded fin must not reduce the bore by more than 0.25mm. Includes Klingerit gasket washer.

Cat No.	Jacket Material			Dim 'A'
	Mild Steel	Copper	Stainless Steel	
3970	M/S	C	S/S	600mm
3971	M/S	C	S/S	1050mm
3972	M/S	C	S/S	1500mm
3973	M/S	C	S/S	1950mm
3974	M/S	C	S/S	2450mm
3975	M/S	C	S/S	2900mm
3976	M/S	C	S/S	3300mm

Order Code example:

Mild steel sheath
3370 M/S

Special note:
Recommend rear
support to be used

Special sizes: specify jacket length Dim. "A".

General Applications

Copper Series

176°C maximum jacket temperature, copper jacket with bronze bush brazed. Normally used for water heating. Can be nickel-plated as an optional extra.

Mild Steel Series

400°C maximum jacket temperature, mild steel jacket with bronze bush brazed. Normally used for heating oil.

Stainless Steel Series

400°C maximum jacket temperature, stainless steel jacket with stainless steel bush brazed. Used for heating air, fuel oil, waxes, fats, dye tanks etc.

Optional Terminal Cover Assembly

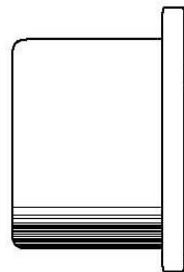

A powder coated spun terminal cover can be supplied for all heater jackets as an optional extra.

Cat. No. 2620-14

Order data: quote catalogue number, application and any special features if required.

Desing Electrolux Macedonia

www.electroluxdesignlab.mk

+38947/203-330 ,203 900+389 2/329 8 130 www.electrolux.com.mk www.elektroluks.com.mk - electrolux@mt.net.mk



Air Heating

Finned Tubular

Application

Designed for rapid uniform heat transfer in air duct heating. Also used in blower type comfort heating units, recirculating ovens and other industrial processing equipment and processes requiring heated air.

Installation

For duct mounting, bushes are designed to provide rigid leak proof support. Heaters should be evenly spaced, preferably at 51mm centres with alternate rows staggered to expose heaters to the downstream air. Minimum distance between heater and duct wall is 12.7mm ($1/2''$). Elements in excess of 330mm should be supported in the centre to prevent excess vibration. Electrical power connections should be made with correct heat resistant cable.

Features

Heavy duty tubular heater of 11mm (.437") diameter steel sheath with continuous edge wound steel fins, 3 turns per cm to an outside fin diameter of 31.75 mm. Where specified elements are coated with a high temperature aluminium paint for operation up to 455°C.

11 mm Series 240 Volt

Complies with AS 1668.1 and AS 9102

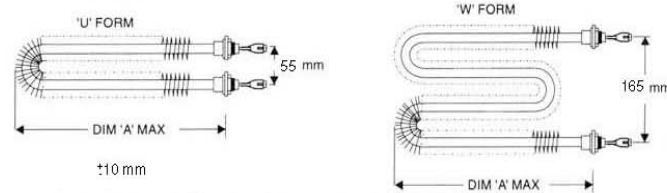

46.5 kW Per Sq. Metre Series (Min. recomm. air velocity 1.0 m/s. Max. sheath temperature 400°C at 20°C ambient)
Delivery ex stock: 1 to 3 weeks. For special wattages and lengths consult your Stokes Synertec representative.

"U" Form					
240 Volt	Cat. No	220 Volt	200 Volt	Ratings	Dim "A"
				Watts	max. (mm)
	2310-U	2951-U	2831-U	600	230
	2311-U	2952-U	2832-U	750	280
	2312-U	2953-U	2833-U	1000	378
	2313-U	2954-U	2834-U	1250	430
	2314-U	2955-U	2835-U	1500	534
	2315-U	2956-U	2836-U	1750	580
	2316-U	2957-U	2837-U	2000	670
	2317-U	2958-U	2838-U	2250	767
	2318-U	2959-U	2839-U	2500	830
	2319-U	2960-U	2840-U	2750	923
	2320-U	2961-U	2841-U	3000	980
	2359-U	2962-U	2842-U	3500	1164
	2302-U	2963-U	2843-U	4000	1280
	2303-U	2964-U	2844-U	4500	1468
	2304-U	2965-U	2845-U	5000	1580

Note: 220 V and 200 V series for export only.

"W" Form					
240 Volt	Cat. No	220 Volt	200 Volt	Ratings	Dim "A"
				Watts	max. (mm)
	2311-W	2952-W	2832-W	750	155
	2312-W	2953-W	2833-W	1000	207
	2313-W	2954-W	2834-W	1250	294
	2314-W	2955-W	2835-W	1500	285
	2315-W	2956-W	2836-W	1750	309
	2316-W	2957-W	2837-W	2000	354
	2317-W	2958-W	2838-W	2250	402
	2318-W	2959-W	2839-W	2500	434
	2319-W	2960-W	2840-W	2750	480
	2320-W	2961-W	2841-W	3000	509
	2359-W	2962-W	2842-W	3500	600
	2302-W	2963-W	2843-W	4000	659
	2303-W	2964-W	2844-W	4500	753
	2304-W	2965-W	2845-W	5000	809

Note: 220 V and 200 V series for export only.

93 kW Per Sq. Metre Series (Min. recomm. air velocity 2.8 m/s. Max. sheath temperature 400°C at 20°C ambient)

"U" Form				
240 Volt	Cat. No.	200 volt	Rating	Dim. 'A' max.
			Watts	mm
	2321-U	2881-U	1000	231
	2322-U	2882-U	1200	231
	2323-U	2883-U	1500	281
	2324-U	2884-U	2000	381
	2325-U	2885-U	2500	431
	2326-U	2886-U	3000	536
	2327-U	2887-U	3500	581
	2328-U	2888-U	4000	671
	2329-U	2889-U	5000	844
	2305-U	2890-U	6000	981

Note: 200 Volt series for export only.

"W" Form				
240 Volt	Cat. No.	200 volt	Rating	Dim "A"
			Watts	max. (mm)
	2323-W	2883-W	1500	155
	2324-W	2884-W	2000	209
	2325-W	2885-W	2500	234
	2326-W	2886-W	3000	287
	2327-W	2887-W	3500	309
	2328-W	2888-W	4000	354
	2329-W	2889-W	5000	440
	2305-W	2890-W	6000	509

Note: 200 Volt series for export only.

Manufacturing data: nominal sheath diameter - 11 mm (.437")
nominal fin diameter - 31.75 mm (1.250")
mounting bushings - $3/8''$ BSP x $1/2''$ long steel terminals - voltage limit = 480V

Desing Electrolux Macedonia

www.electroluxdesignlab.mk



Air Heating

11 mm series "Multi Form"

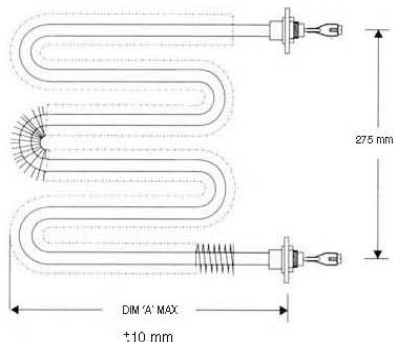

46.5 kW per Sq. Metre series

(Min. recomm. air velocity 1.0 m/s. Max. sheath temperature 400°C at 20°C ambient). This range complies with AS 1668.1 and AS 3102.

"X" Multi Form					
240 Volt	Cat. No.	200 Volt	Rating Watts	Dim. 'A' max. mm	Kg
2314-X	2955-X	2835-X	1500	200	1.00
2315-X	2956-X	2836-X	1750	215	1.00
2316-X	2957-X	2837-X	2000	248	1.25
2317-X	2958-X	2838-X	2250	280	1.40
2318-X	2959-X	2839-X	2500	302	1.50
2319-X	2960-X	2840-X	2750	332	1.75
2320-X	2961-X	2841-X	3000	352	1.80
2359-X	2962-X	2842-X	3500	412	2.10
2302-X	2963-X	2843-X	4000	452	2.30
2303-X	2964-X	2844-X	4500	514	2.60
2304-X	2965-X	2845-X	5000	552	2.90

Note: 220 V and 200 V series for export only

93 kW per Sq. Metre series

(Min. recomm. air velocity 2.8 m/s. Max. sheath temperature 400°C).

"X" Multi Form					
240 Volt	Cat. No.	200 Volt	Rating Watts	Dim. 'A' max mm	Kg
2326-X	2886-X	2886-X	3000	200	1.00
2327-X	2887-X	2887-X	3500	215	1.10
2328-X	2888-X	2888-X	4000	248	1.25
2329-X	2889-X	2889-X	5000	306	1.60
2305-X	2890-X	2890-X	6000	352	1.90

"Multi formed" elements are formed with an additional "U" bend to the standard "W" form range.

Advantage

Dim. "A" is shortened enabling a higher wattage element to be fitted to a more compact size duct.

Note: 200 & 220 Volt series for export only.

Straight Length - Finned Tubular



46.5 kW per Sq. Metre series

Straight - Finned Tubular					
240 Volt	Cat. No.	200 Volt	Rating Watts	Dim. 'A' max. mm	Kg
2310-10	2951-10	2831-10	600	460	0.40
2311-10	2952-10	2832-10	750	560	0.50
2312-10	2953-10	2833-10	1000	753	0.60
2313-10	2954-10	2834-10	1250	860	0.75
2314-10	2955-10	2835-10	1500	1065	1.00
2315-10	2956-10	2836-10	1750	1160	1.00
2316-10	2957-10	2837-10	2000	1340	1.25
2317-10	2958-10	2838-10	2250	1532	1.40
2318-10	2959-10	2839-10	2500	1660	1.50
2319-10	2960-10	2840-10	2750	1843	1.75
2320-10	2961-10	2841-10	3000	1960	1.80
2359-10	2962-10	2842-10	3500	2326	2.10
2302-10	2963-10	2843-10	4000	2560	2.30
2303-10	2964-10	2844-10	4500	2934	2.60
2304-10	2965-10	2845-10	5000	3160	2.90

Note: 220 V and 200 V series for export only.

Manufacturing data: nominal sheath diameter - 11 mm (.437")
nominal fin diameter - 31.75 mm (1.250")
mounting bushings - 3/8" BSP x 1/2" long steel
terminals - voltage limit = 480V

96 kW per Sq. Metre series

Straight - Finned Tubular					
240 Volt	Cat. No.	200 Volt	Rating Watts	Dim. 'A' max. mm	Kg
2321-10	2881-10	2881-10	1000	460	0.50
2322-10	2882-10	2882-10	1200	460	0.50
2323-10	2883-10	2883-10	1500	560	0.60
2324-10	2884-10	2884-10	2000	760	0.80
2325-10	2885-10	2885-10	2500	860	0.90
2326-10	2886-10	2886-10	3000	1070	1.00
2327-10	2887-10	2887-10	3500	1160	1.10
2328-10	2888-10	2888-10	4000	1340	1.25
2329-10	2889-10	2889-10	5000	1686	1.60
2305-10	2890-10	2890-10	6000	1960	1.90

Note: 220 V and 200 V series for export only.

Note: Straight length elements should be mounted in the vertical plane and rigidly secured at one end to allow the element to expand.

Straight length elements are supplied with a floating bush.

Desing Electrolux Macedonia

www.electroluxdesignlab.mk



Air Heating

Finned Tubular 8mm series

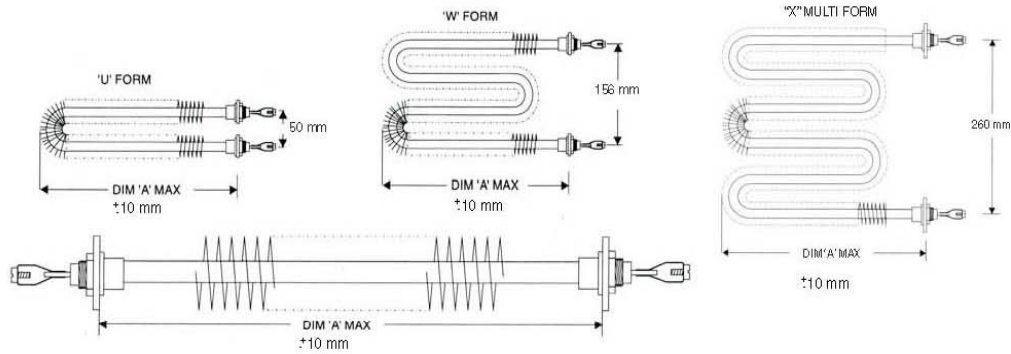

31 kW per Sq. Metre Series

Air heater element - finned tubular - painted
20 Watts per square inch series
Tube diameter 8mm/ outside diameter 22mm
Complies with AS 1668.1 and AS 3102

Air Heating Elements-Finned Tubular					
Cat. No.		Watts	"A" Dim.	Kg	
240 Volt	220 Volt				
"U" Form					
2761-U	2991-U	2921-U	500	380	0.46
2762-U	2992-U	2922-U	750	533	0.65
2763-U	2993-U	2923-U	1000	710	0.85
2764-U	2994-U	2924-U	1500	1010	1.10
2765-U	2995-U	2925-U	1800	1200	1.20
2766-U	2996-U	2926-U	2000	1327	1.50
2767-U	2997-U	2927-U	2400	1580	1.60
"W" Form					
2761-W	2991-W	2921-W	500	200	0.46
2762-W	2992-W	2922-W	750	280	0.65
2763-W	2993-W	2923-W	1000	368	0.85
2764-W	2994-W	2924-W	1500	520	1.10
2765-W	2995-W	2925-W	1800	616	1.20
2766-W	2996-W	2926-W	2000	680	1.50
2767-W	2997-W	2927-W	2400	806	1.60
"X" Multi Form					
2762-X	2992-X	2922-X	750	200	0.65
2763-X	2993-X	2923-X	1000	260	0.85
2764-X	2994-X	2924-X	1500	360	1.10
2765-X	2995-X	2925-X	1800	424	1.20
2766-X	2996-X	2926-X	2000	467	1.50
2767-X	2997-X	2927-X	2400	550	1.60
Straight Elements					
2761-10	2991-10	2921-10	500	760	0.46
2762-10	2992-10	2922-10	750	1065	0.65
2763-10	2993-10	2923-10	1000	1425	0.85
2764-10	2994-10	2924-10	1500	2017	1.10
2765-10	2995-10	2925-10	1800	2398	1.20
2766-10	2996-10	2926-10	2000	2652	1.50
2767-10	2997-10	2927-10	2400	3160	1.60

Note: 220 / 200V for export only

108 kW per Sq. Metre Series

Air heater element - finned tubular - painted
70 Watts per square inch series
Tube diameter 8mm/ outside diameter 22mm

Air Heating Elements-Finned Tubular					
Cat. No.		Watts	"A" Dim.	Kg	
240 Volt	220 Volt				
"U" Form					
3321-U	2971-U	2981-U	600	210	0.26
3322-U	2972-U	2982-U	900	222	0.27
3323-U	2973-U	2983-U	1200	273	0.28
3324-U	2974-U	2984-U	1500	330	0.35
3325-U	2975-U	2985-U	1800	380	0.46
3326-U	2976-U	2986-U	2000	420	0.52
3327-U	2977-U	2987-U	2400	495	0.56
3328-U	2978-U	2988-U	3000	603	0.65
3329-U	2979-U	2989-U	3600	711	0.87
3330-U	2980-U	2990-U	4800	915	0.99
3320-U	2940-U	2950-U	6000	1175	1.30
"W" Form					
3323-W	2973-W	2983-W	1200	153	0.28
3324-W	2974-W	2984-W	1500	180	0.35
3325-W	2975-W	2985-W	1800	200	0.46
3326-W	2976-W	2986-W	2000	222	0.52
3327-W	2977-W	2987-W	2400	260	0.26
3328-W	2978-W	2988-W	3000	315	0.65
3329-W	2979-W	2989-W	3600	368	0.81
3330-W	2980-W	2990-W	4800	476	0.99
3320-W	2940-W	2950-W	6000	600	1.30
"X" Multi Form					
3328-X	2978-X	2988-X	3000	220	0.65
3329-X	2979-X	2989-X	3600	260	0.81
3330-X	2980-X	2990-X	4800	329	0.99
3320-X	2940-X	2950-X	6000	417	1.30
Straight Elements					
3321-10	2971-10	2981-10	600	440	0.26
3322-10	2972-10	2982-10	900	440	0.27
3323-10	2973-10	2983-10	1200	544	0.28
3324-10	2974-10	2984-10	1500	658	0.35
3325-10	2975-10	2985-10	1800	760	0.46
3326-10	2976-10	2986-10	2000	836	0.52
3327-10	2977-10	2987-10	2400	988	0.56
3328-10	2978-10	2988-10	3000	1204	0.65
3329-10	2979-10	2989-10	3600	1420	0.87
3330-10	2980-10	2990-10	4800	1852	0.99
3320-10	2940-10	2950-10	6000	2350	1.30

Air Heating

Terminal Boxes

Standard Terminal Box specifications

- Constructed from 22 gauge zinc anneal material.
- Spot welded construction.
- 100mm deep, 20mm wide mounting flanges.
- Removable cover including identification plate.
- Notched conduit entries at both ends (25 mm dia.).
- Face of box is lined with 6mm thick, asbestos free insulation board.

Non standard boxes

Boxes can be manufactured to special dimensions other than those listed.

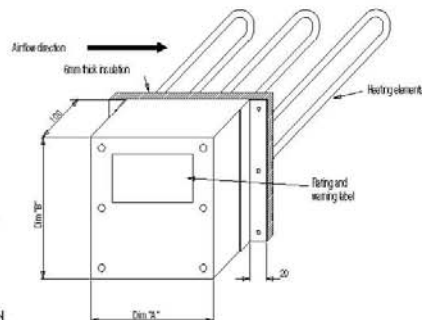

Note: Numbers of elements quoted are maximum in each case. Where a long box is required to accommodate the duct, the elements are evenly spaced to cover the face area of the duct.

Type & Maximum Number of Elements Accommodated										
W.P.=Weatherproof series		Terminal Boxes			Finned Elements			Unfined Elements		
HD=Heavy duty Design		Cat.No.	Dim "A"	Dim "B"	Max Element	Max Element	Max Element	Max Element	Max Element	
W.P.	HD.	Standard	mm	mm	"U" Form	"W" Form	Multi Form	"U" Form	"W" Form	
4451	3931	2330	150	150	-	3	-	3	3	
4452	3932	2331	150	225	-	6	3	6	3	
4453	3933	2332	150	300	-	9	3	6	6	
4454	3934	2333	150	375	-	9	3	9	6	
4455	3935	2334	150	450	-	12	6	12	9	
4456	3936	2335	150	600	-	18	6	18	12	
4457	3937	2336	225	150	*3	4	1	4	3	
4458	3938	2337	225	225	*3	6	3	6	3	
4459	3939	2338	225	300	*6	9	6	6	6	
4460	3940	2339	225	375	*9	12	6	12	6	
4461	3941	2340	225	450	*12	16	8	16	12	
4462	3942	2341	225	600	*15	21	9	24	15	
4463	3943	2342	300	150	*3	6	2	6	6	
4464	3944	2343	300	225	*6	9	6	9	6	
4465	3945	2344	300	300	*9	12	6	12	12	
4466	3946	2345	300	375	*12	18	9	18	12	
4467	3947	2346	300	450	*18	24	12	24	15	
4468	3948	2347	300	600	*32	42	15	42	24	

Note: If pressure switches are to be fitted into the "U" Form column then only the quantity marked with an asterisk "*" is to be used.

A = width of box along duct

B = minimum possible height of duct for upright box fitting

Optional Controls

- Refer to the Control section for the standard types of controls available that can be fitted within the terminal boxes.
- Hi Limits
- Pressure switches

Desing Electrolux Macedonia

www.electroluxdesignlab.mk

+38947/203-330 ,203 900+389 2/329 8 130 www.electrolux.com.mk www.elektroluks.com.mk - electrolux@mt.net.mk



Air Heating

Duct Heater Selection Tables

Comprising: Low Temperature Finned Elements (Commonly termed as Black Heat Elements)

Maximum sheath temperature: 400°C in still air at 20°C ambient.

Elements: 240 volts

Includes: 6mm thick insulation on terminal box face.

All units suitable for connection to 3 phase 415/240 volt 4 wire supply.

Specification delivery: 10 to 15 workings days.

Maximum operating air temperature: 100°C (for higher operating temperatures contact Stokes Synertec)

Note: non standard units manufactured to clients requirements. When ordering specify catalogue number, quantity, wattage and type of over temperature protection (if required).

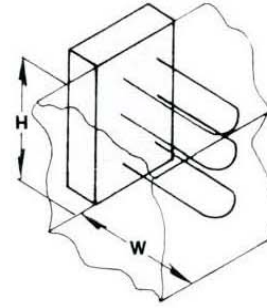

This range complies with AS1668.1 and AS3102

Cat.No.	Kw	Min. Duct Size Wmm x Hmm	No. of Elements	Elements	Terminal Box	Min. Air Flow m ³ /s
LF 1	1.0	400 x 150	1	2312 U	2330	0.060
LF 2	2.0	400 x 150	2	2312 U	2330	0.060
LF 3	3.0	400 x 150	3	2312 U	2330	0.060
LF 4	4.5	560 x 150	3	2314 U	2330	0.084
LF 5	6.0	700 x 150	3	2316 U	2330	0.105
LF 6	7.5	900 x 150	3	2318 U	2330	0.135
LF 7	9.0	400 x 225	3	2312 U	2331	0.090
LF 8	6.0	400 x 225	6	2312 U	2331	0.090
LF 9	9.0	560 x 225	6	2314 U	2331	0.126
LF 10	12.0	700 x 225	6	2316 U	2331	0.158
LF 11	15.0	900 x 225	6	2318 U	2331	0.203
LF 12	5.4	250 x 300	9	2310 U	2338	0.075
LF 13	9.0	400 x 300	9	2312 U	2338	0.120
LF 14	13.5	560 x 300	9	2314 U	2338	0.168
LF 15	18.0	700 x 300	9	2316 U	2338	0.210
LF 16	22.5	900 x 300	9	2318 U	2338	0.270
LF 17	27.0	1000 x 300	9	2320 U	2338	0.300
LF 18	12.0	400 x 375	12	2312 U	2339	0.150
LF 19	18.0	560 x 375	12	2314 U	2339	0.210
LF 20	24.0	700 x 375	12	2316 U	2339	0.263
LF 21	30.0	900 x 375	12	2318 U	2339	0.340
LF 22	36.0	1000 x 375	12	2320 U	2339	0.375
LF 23	48.0	1300 x 375	12	2302 U	2339	0.488

Cat.No.	Kw	Min. Duct Size Wmm x Hmm	No. of Elements	Elements	Terminal Box	Min. Air Flow m ³ /s
LF 24	15.0	400 x 450	15	2312 U	2340	0.180
LF 25	22.5	560 x 450	15	2314 U	2340	0.252
LF 26	30.0	700 x 450	15	2316 U	2340	0.315
LF 27	37.5	900 x 450	15	2318 U	2340	0.405
LF 28	45.0	1000 x 450	15	2320 U	2340	0.450
LF 29	60.0	1300 x 450	15	2302 U	2340	0.585
LF 30	18.0	400 x 600	18	2312 U	2341	0.240
LF 31	27.0	560 x 600	18	2314 U	2341	0.336
LF 32	36.0	700 x 600	18	2316 U	2341	0.420
LF 33	45.0	900 x 600	18	2318 U	2341	0.540
LF 34	54.0	1000 x 600	18	2320 U	2341	0.600
LF 35	72.0	1300 x 600	18	2302 U	2341	0.780

Compact Duct Assemblies

Cat.No.	Kw	Min. Duct Size Wmm x Hmm	No. of Elements	Elements	Terminal Box	Min. Air Flow m ³ /s
LF 36	1	220 x 150	1	2312 W	2336	0.030
LF 37	2	220 x 225	2	2312 W	2331	0.045
LF 38	3	220 x 225	3	2312 W	2337	0.045
LF 39	6	400 x 225	3	2316 W	2337	0.090
LF 40	9	540 x 225	3	2320 W	2337	0.122
LF 41	12	400 x 300	6	2316 W	2344	0.120
LF 42	15	480 x 300	6	2318 W	2344	0.144
LF 43	18	550 x 300	6	2320 W	2344	0.165
LF 44	24	700 x 300	6	2302 W	2344	0.210
LF 45	27	550 x 450	9	2320 W	2346	0.248



Air Heating

Finned tubing data

Custom manufactured to suit individual requirements with various combinations of fin and tube material.

Application:

Heat exchangers
After coolers and air compressors
Steam coils and radiators

Tube data materials:

Copper, brass, mild steel or stainless steel.
All tubing has to be hard drawn type.
Maximum length - 6 metres (L)
Maximum diameter - 20mm (D)
Minimum diameter - 6.53mm
For wall thickness contact Stokes Synertec.
Full anneal after finning (on request)

Fin data materials:

Brass, mild steel or stainless steel.
Maximum fin height (W) = tube diameter (D)
Minimum fin height is subject to availability
Fin maximum pitch = diameter (D) x 75%
Fin minimum pitch = 3mm (P)
Fin tension - wound tightly to tube to ensure maximum thermal conductivity.

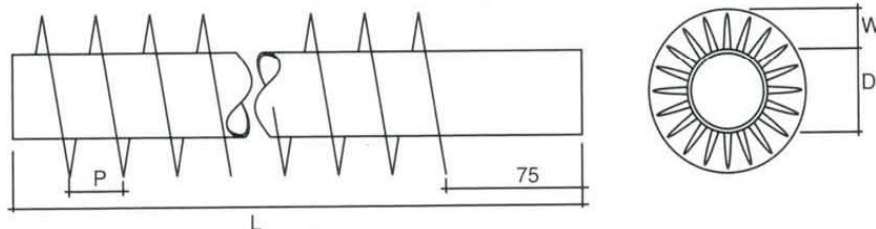

Radiant Infra-red Heaters (Ceramic)



Why Infra-red?

- Rapid heating rate reduces production time.
- Matching emitter peak wave lengths to material absorption characteristics gives efficient heating.
- High efficiency of emitters reduces running costs.
- Accurate control of emitters helps reduce wastage.
- Even heating pattern improves product finish.

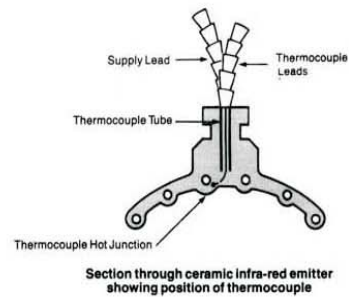
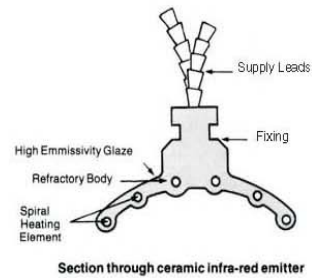
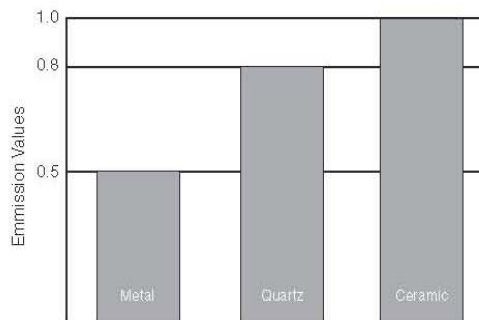

Radiant Infra-red Heaters (Ceramic)

Application Data

Wattage	150	250	400	500	650	750	1000 Type F.T.E
		125	200	250	325		500 Type H.T.E
		250	400	500	650	750	1000 Type F.T.E Thermocouple
		125	200	250	325		500 Type H.T.E Thermocouple
Mean Surface Temp. 0°C	310	418	515	560	630	750	755 Applicable to both types
Max. Permitted Temp.	800°C for all types of emitters						
kW per M²	Loadings of up to 60 kW/M ² are possible						
Emission Peak	5.00	4.20	3.70	3.40	3.20	3.10	2.90
Wavelength from	2.70	2.20	2.00	1.90	1.75	1.70	1.60
In Microns Tp	11.00	9.00	7.80	7.40	6.80	6.60	6.20

On the grounds of efficiency and economy we strongly recommend that the emission and receiving wavelengths be matched as closely as possible. If you care to send us a sample of the material, paint or solvent used in the process we shall be very happy to advise.

Specially designed terminal blocks have been designed for use with our elements. They are completely "NON-ARC" and rated at 15 amps. Type "2 way" 25 x 28 x 18mm. Elongated cable inserts, 2BA brass securing screws and each has a 2 hole fixing.

Applications	150W	250W	400W	650W	1000W
Pre-heating of foil for vacuum forming					
Manufacture of bubble sealed packs					
Setting of PVC paste on fabrics					
Pre heating of GFK parts during manufacture					
Heating of paper pulp prior to pressure					
Quick drying of laquered paper					
Quick drying of gummed and sized paper					
Activating of two part adhesives					
Drying of Plastics and Latex coatings					
Drying of washed, dyed and finished textiles					
Fixing of Nylon and Perlon thread					
Pre-heating and drying of glued wooden furniture					
Drying of skins and sprayed leather					
Heating and drying of adhesives in the shoe trade					
Drying of glazed tiles					
Drying and setting of protective coatings in tins					
Drying and setting of laquered sheet metals					

Element type F.T.E. 245mm long x 60mm wide. H.T.E 122mm long x 60mm wide.

The above are just a few of the possible applications where correct wavelength infra-red could be utilised to speed production schedules and achieve a vastly improved end product. Contact our technical department for further advice.

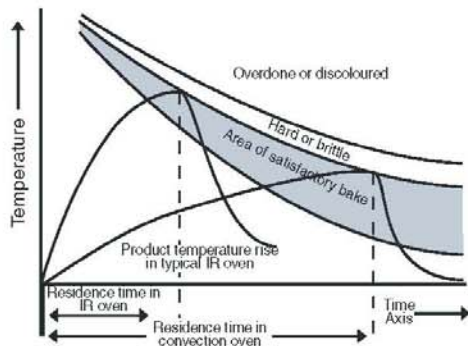

The use of infra-red heaters in non contact heating systems gives rapid energy transfer from emitter to product with little or no effect on the intervening medium.

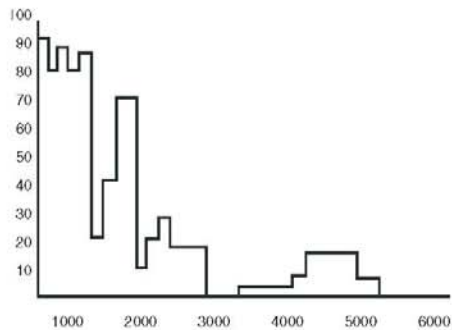

The absorption characteristics of a typical thermo plastic. Close matching of emission and absorption characteristics offers efficient energy usage.

Ovoj ctez e spostenost na Elektroluks.Bez negovo pismeno odobruvanje istoi nesmee da se precisira, umozuva ili kopira bez soglasnost od **Elektroluks** vo sprotno se snoset posledici vo smislana celovitel 163 i 164 od klicniot zakon R.M. (povreda na avtorsko pravo

Elektroluks is registered trademark of Elektroluks companies in Macedonia and other countries



Radiant Infra-red Heaters (Ceramic)

Half Trough Elements

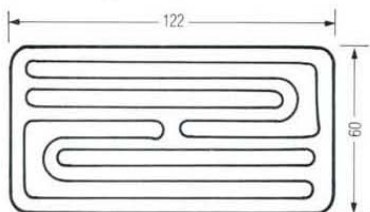

Cat. No.	Watts	Volts
HTE 125	150	240
HTE 200	200	240
HTE 250	250	240
HTE 325	325	240
HTE 500	500	240

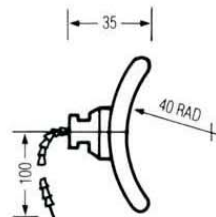

Cat. No.	Watts	Volts
HTE 125 T/C	150	240
HTE 200 T/C Built-in	200	240
HTE 250 T/C Thermocouple	250	240
HTE 325 T/C	325	240
HTE 500 T/C	500	240

Note: - Element has four leads
 - Centre leads are for thermocouple connections

Full Trough Elements

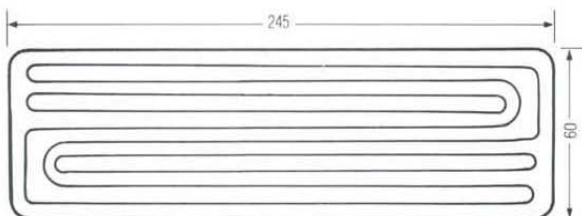

Cat. No.	Watts	Volts
FTE 150	150	240
FTE 250	250	240
FTE 400	400	240
FTE 500	500	240
FTE 650	650	240
FTE 750	750	240
FTE 1000	1000	240

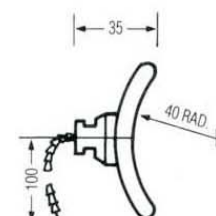

Cat. No.	Watts	Volts
FTE 150 T/C	150	240
FTE 250 T/C	250	240
FTE 400 T/C Built-in	400	240
FTE 500 T/C Thermocouple	500	240
FTE 650 T/C	650	240
FTE 750 T/C	750	240
FTE 1000 T/C	1000	240

Polished Stainless Steel Reflectors

Cat. No.	Size
2300 -1	For HTE - 125mm x 95.5mm
2301 -1	For FTE - 250mm x 95.5mm

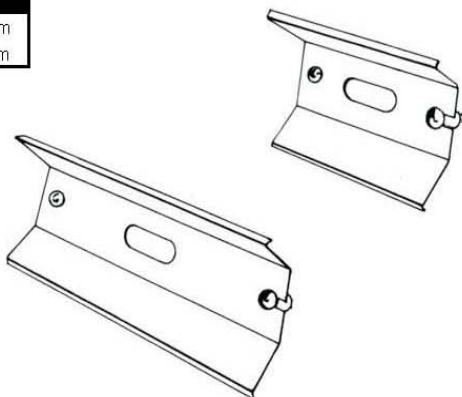

Note: Complete with mounting screws, washers and nuts.

Desing Electrolux Macedonia

www.electroluxdesignlab.mk



Radiant Infra-red Heaters (Ceramic)

Fixing Arrangements

	A	B	C
Standard fixing	39	14	7

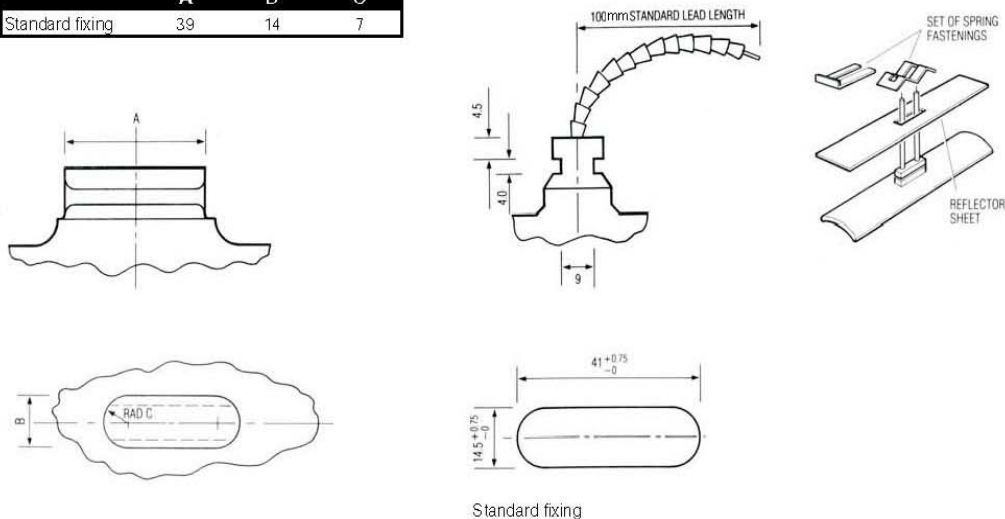

Physical dimensions

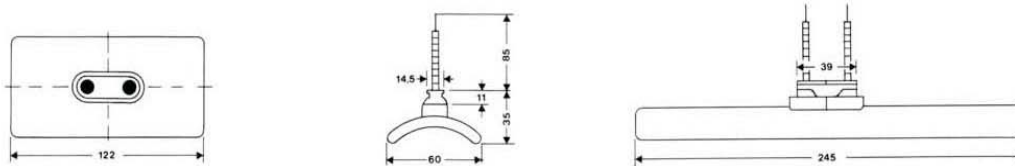

Element complete with mounting clips

Spectral Graphs

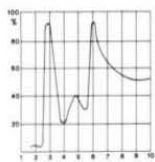

Wavelength (µm)

Fig 1. Spectral absorption of water with heavy absorption in the 3 micron band.

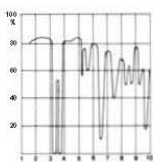

Wavelength (µm)

Fig 2. Spectral absorption for polystyrene showing maximum absorption in the 3/5 micron band.

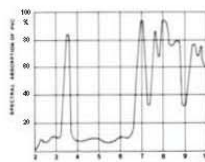

Wavelength (µm)

Fig 3. Spectral absorption of PVC. The main absorption range lies between the 3, 7 and 10µm. The curves for other plastics exhibit a similar character.

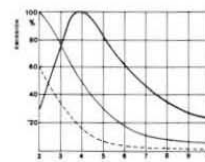

Wavelength (µm)

Fig 4. Emissions spectrum of black radiators. Dotted 2100°C (visible radiators) black 1100°C (quartz radiators) grey 510°C (ceramic radiators) best range 9-10µm.



Radiant Infra-red Heaters (Ceramic)

Edison Screw Elements

A

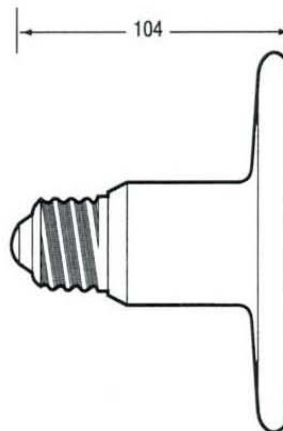
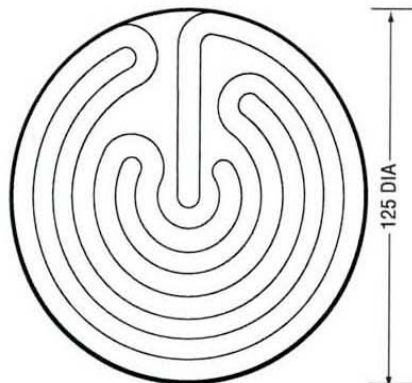

Edison Screw Elements are used extensively by pig and poultry breeders. Other applications include paint drying for motor body panels and the heating of humidicribs to name just a few.

Edison Screw Elements are available in three wattages and sizes at 240 volts.



	Cat. No.	Wattages	Face Diam. mm
	2306 ESE 150	150	125
"A" type	2306 ESE 250	250	125
	2306 ESE 500	500	125

General Applications

- Pig and Poultry breeders
- Paint drying
- Heating of Humidicribs
- Food warming

Radiant Infra-red Heaters (Ceramic - Optional Parts)

Screw Holder

Suspension type
Cat. No 9209

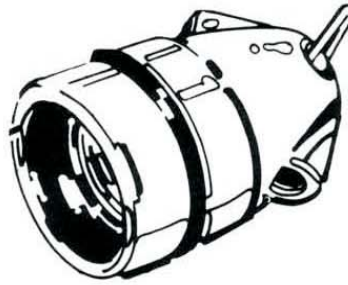

Reflectors

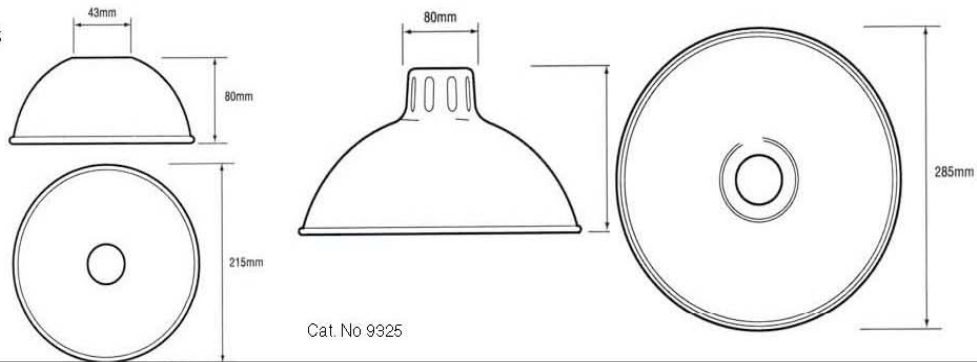

Cat. No 9924

Cat. No 9925

Two way Ceramic Block

2 - way 15amp
Stainless Steel

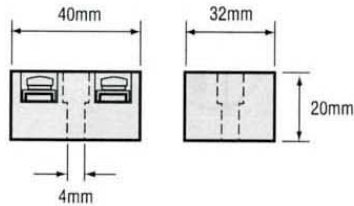

Cat. No.

Size

2900-15

40mm longx20mm. highx32mm. wide

Solid State Controls

Non indicating type



Cat. No. PN4AIC-M 0800 K
0-800°C

Indicating type



Cat. No. PF4AIC-M 0800 K
0-800°C

Energy Regulator

Cat. No. TYJ6399 19 Amp. rating



Note: A complete range of Digital Temperature Controllers and Thermocouples are available on customer request.

Desing Electrolux Macedonia
www.electroluxdesignlab.mk

+38947/203-330 ,203 900+389 2/329 8 130 www.electrolux.com.mk www.elektroluks.com.mk - electrolux@mt.net.mk



Elektroluks is registered trademark of Elektroluks companies in Macedonia and other countries

Radiant Infra-red Heaters (Metal Sheathed)

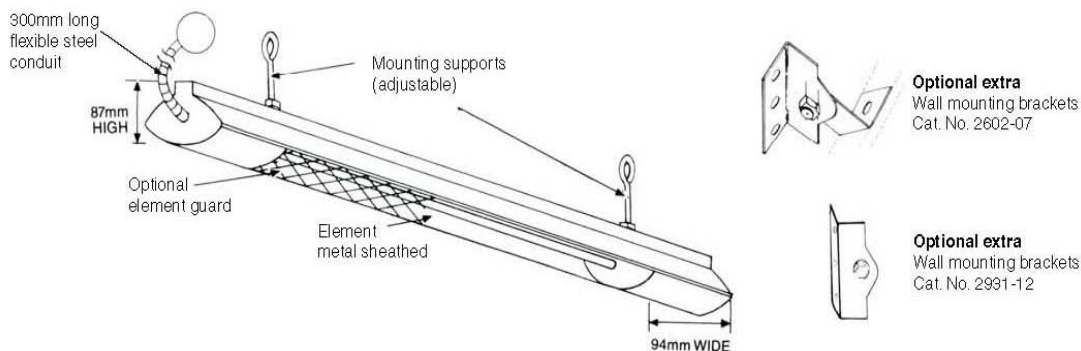

General applications

- **Comfort Heating**
Warehouses, Workshops, Schools, Halls, Churches
- **Oven Heating**
motor windings, process heating, drying etc.
- **Baking and Curing**
paints, enamels, lacquers adhesives and ink
- **Drying**
metals, ores, powders, sandpaper, textiles and food
- **Food warming**
canteens, foodstores, restaurants etc.

Cat. No.		Overall Length		
240V	220V	200V	Wattage	mm
3871	3861	3851	800	610
3872	3862	3852	1100	770
3873	3863	3853	1800	1180
3874	3864	3854	2400	1550
3875	3865	3855	3000	1865
3876	3866	3856	3600	2170

Replacement parts for Infra-red heaters

Cat no	Elements	Element Length mm	Guards	Guard Length mm
3871	3871-10	515	2601-36	425
3872	3872-10	670	2602-36	995
3873	3873-10	1085	2603-36	995
3874	3874-10	1450	2604-36	995
3875	3875-10	1770	2605-36	1365
3876	3876-10	2070	2606-36	1685

Note: The heaters listed come complete with Junction Box, Mounting Supports (eye bolts). All units are wired to the Junction Box.

220 / 200 V for export only

Installation

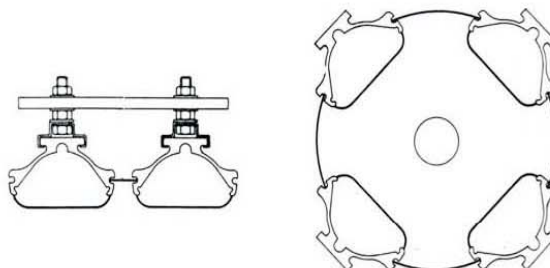
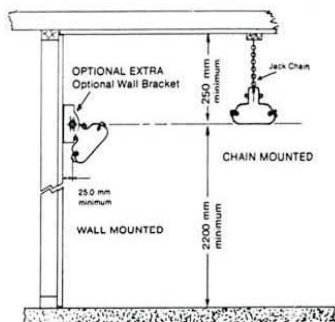

Drum Heaters

Base heater

The **Electrolux** base drum heater is a cost effective and efficient solution for heating 200 litre (44 gal) steel drums. Unlike most other drum heating methods, heat is evenly transferred throughout the drum ensuring efficiency.

Insulation covers are available to increase efficiency even further.

The base is manufactured from mild steel and can be bolted to the ground for added security.



Applications:

- Oils
- Grease
- Resins
- Chemicals
- Adhesives
- Tar
- Paint

Temperature range: 30°C to 110 °C

Cat. No. 4105 (3600W / 240V)

Metal Band Drum heater

Electrolux Metal Band Drum Heater is a portable solution for heating 200 Litre(44 gal) type drums.

It is ideal for heating low melting point solids and thick viscous liquids such as oils, fats, paints, chemicals etc.

The unit has been designed to clamp around a standard drum with a simple spring attachment ensuring good contact.

Incorporates: Thermostat control (30°C - 110°C)

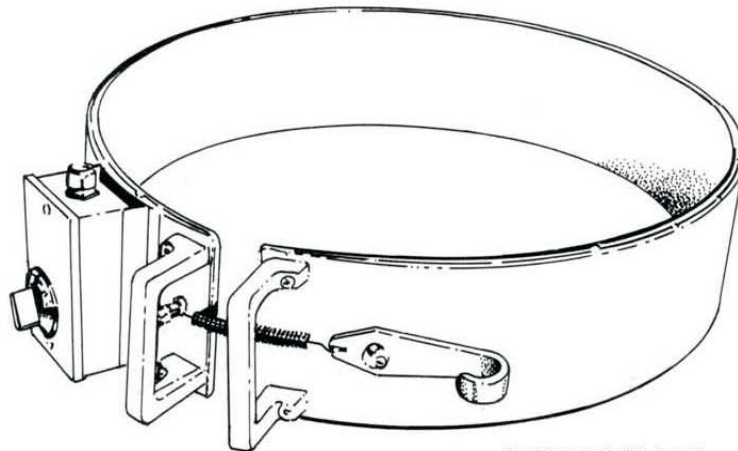

Cat No. 3180 (2KW / 240V)

Desing Electrolux Macedonia

www.electroluxdesignlab.mk



Inline Water Heaters

The **Electrolux** Inline Heater is designed as a full flow heater which may be installed as part of a pipe circuit. Since the unit is manufactured from PVC material it can be glued to the existing pipework.

Electrolux inline heater housing and fittings are manufactured from high grade PVC material to allow easy installation. Generally it is connected to PVC fittings. Heated parts are protected by a 316 stainless steel heat shield.

PVC is inert and as a result eliminates corrosion and is weatherproof. Synertec inline heaters also incorporate an incoloy sheathed element for optimum reliability and life.

For added protection and safety an over-temperature manual reset thermal cutout is included. A calibrated control thermostat assists temperature selection. The control thermostat limits water temperature so that it does not exceed safe levels.

Sizes available:

Cat. No.	Watts	Voltage	Dim "A"
2960	2,400	240	665mm
2961	3,000	240	730mm
2962	6,000	240	1000mm
2963	30,000	240/415	1250mm

Replacement Over Temperature Control:

Cat. No. 2960-36 Overtemp Thermostat to suit Inline Heaters.

Note: 3 pin plug and cord not supplied with units 2962 and 2963.

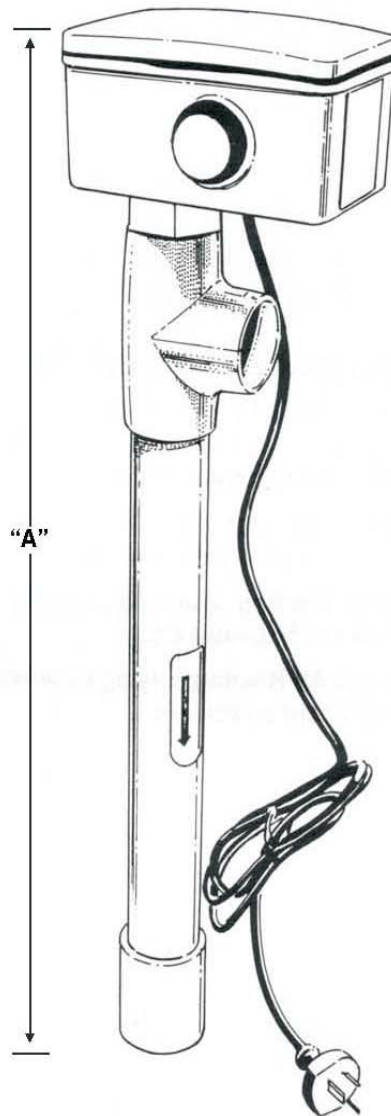

Elektroluks is registered trademark of Elektroluks companies in Macedonia and other countries

Desing Electrolux Macedonia

www.electroluxdesignlab.mk

+38947/203-330 ,203 900+389 2/329 8 130 www.electrolux.com.mk www.elektroluks.com.mk electrolux@mt.net.mk



Cubicle Heating Elements

Design features:

- Finned tubular element for low sheath temperature.
- Aluminium painted element for corrosion resistance.
- Mounting brackets for easy installation.
- Cable entry for flexible lead etc.

Typical applications:

- Anti-condensation heaters for switchboard cubicles.
- Ovens and cabinets for drying, baking, pre-heating and melting.
- Hot cupboards, food trolleys, incubators.

Straight Form Element

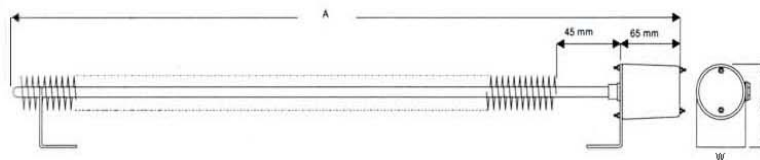

“U” Form Element

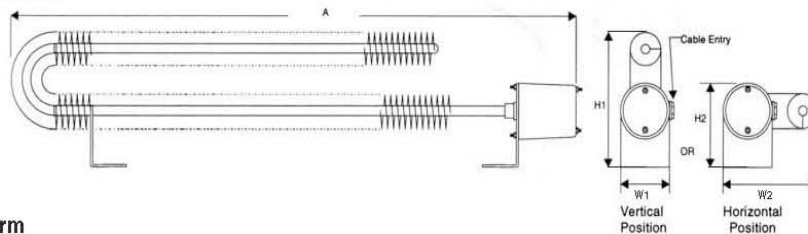

Straight Form

Cat. No.	Wattage	Voltage	Length A	Width W	Height H
2941	60	240	995mm	50mm	75mm
2942	100	240	640mm	50mm	75mm
2943	150	240	790mm	50mm	75mm
2944	300	240	1355mm	50mm	75mm

“U” Form

Cat. No.	Wattage	Voltage	Length A	Width W1	Height H1	Width W2	Height H2
2941-U	60	240	555mm	50mm	120mm	100mm	75mm
2942-U	100	240	380mm	50mm	120mm	100mm	75mm
2943-U	150	240	425mm	50mm	120mm	100mm	75mm
2944-U	300	240	725mm	50mm	120mm	100mm	75mm

Manufacturing Data:

Nominal sheath diameter - 11mm (.437")
Nominal fin diameter - 31.75mm (1.250")

Controls - General Information

General Information

An effective control system cannot simply depend on the sensitivity of the control itself. *Three major factors influence the controllability of the entire system:

Temperature differences throughout the system should be minimized. Pumping or agitating a liquid, particularly a viscous one, helps reduce temperature variations. Temperature uniformity in solids is achieved by spacing elements at frequent intervals and far enough away from the working surface to allow temperatures to even out; by choosing an element shape compatible with the shape of the solid (flat heaters for flat surfaces, curved strip heaters for cylinders, etc.); and by insulating exposed edges.

Thermal lag - The time between energizing the heaters and a temperature increase at any point in the system can cause overshoot and undershoot of control settings. Generally, a short thermal lag is desirable in order to produce a temperature rise quickly when the elements are turned on and a quick cooling effect when they are turned off. For liquids, agitating or pumping helps reduce thermal lag. For gases, forced circulation transfers heat more rapidly than does natural convection. Lightweight heating elements also cut down thermal lag. Thus open coil elements are often preferred to enclosed elements for oven heating applications. When heating solids, the overall mass of the system should be kept to a minimum. Materials such as aluminium are preferred because of their high thermal conductivity and low specific heat.

Often there must be a compromise between low thermal lag and good temperature uniformity - e.g. a massive platen tends to have a more uniform temperature over its face, but responds slowly when elements are turned on and off, resulting in long warm-up and cooling periods. Good distribution of the heating source and proper choice of the control (see "Choosing The Right Controller") are essential in this situation.

Heating capacity, or installed wattage, should match the system requirements as closely as possible. Too little heat will of course produce temperatures that are too low. Conversely, if the system is designed with far more wattage than required, temperatures will overshoot and undershoot the control setting substantially as the heaters cycle on and off. Multi-stage controls can help correct this situation, but from the standpoint of economy, it is always better to choose the correct wattage and control it with a simple thermostat. Systems requiring substantially more heat initially than after the system is running should be designed with two or more stages of control. Control sensitivity is the inherent ability of the switching mechanism to respond to temperature changes in the sensing medium (liquid fill or bimetal). In practice a system is rarely controlled to within the limits of the control's sensitivity, due to other factors in the system.

Choosing the right control

For most industrial applications, series 2370 is used because of its rugged construction, high load-carrying capacity, and simplicity of operation. When the capacity of series 2370 is exceeded the load must be switched on and off by a magnetic contactor.

Protective devices

Thermal cut-outs are thermostatic devices used to protect product or heater overheat by opening heater circuit(s) at a pre-set temperature above the control temperature in case of malfunctioning of some component in the system. They are wired in a series with control thermostat(s) and shut down the system if overheating occurs. Equipped with reset buttons, they must be reset manually to re-energise the heaters.

* Note:

After system has been checked by authorised personnel to correct any malfunctioning.

Placement of the sensing bulb near the work protects the product against overheat. Likewise, placement of bulb near the heat source protects the heaters. In heating systems where work is distant from the heaters, two cut-outs can be used, with one bulb placed near the work and the other near the heaters.

Low-liquid cut-offs are used in conjunction with immersion heaters to prevent heater burn-out due to low liquid levels. After liquid level is restored, the control is reset manually to re-energise the heater.

Other methods of control

Single and three-heat switches are used to manually control heating loads. Single-heat switches provide on-off control and may be used to operate the holding coil of a contactor for single-phase loads greater than the switch capacity, or for the three-phase loads. Three-heat switches used with two heating elements or circuits of equal rating provide low, medium and high heats. Controlling heater output by manually varying input voltage is accomplished by means of a variable transformer. This is a precise method of control and permits exact matching of heat to work requirements.



Wiring Installation

Wiring Hints

It should always be remembered that wiring may be operating at high temperatures, although the ambient temperature is relatively low. This may be the result of conducted heat from heater terminals or radiation from heated surfaces.

Under these circumstances, or where ambient temperatures are high, special high temperature wiring should be used. This normally consists of high temperature nickel or alloy wire and heat-resistant insulation such as silicon and/or fibreglass.

Installing Heater Wiring

- All heater terminal connections should be firmly tightened as allowed by terminal strength. Where possible, terminals should be supported while tightening connections to prevent twisting of the terminals.
- Where the wire and terminals may be subjected to expansion and contraction, causing movement of the wire, stranded wire is preferred. One way to compensate for this, is to leave liberal expansion loops between points of support in solid wire or small bus bar.
- Separate conduit should be provided for thermocouple circuit wiring.
- Do not allow thermocouple wiring or capillary tubing of thermostat to approach heater terminals.

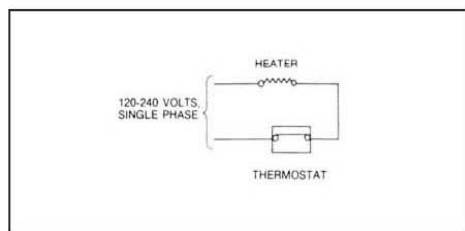

Fig.1 Single phase heater controlled by a single pole thermostat.

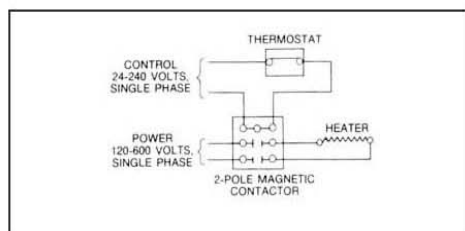

Fig.2 Single phase heater controlled through a magnetic contactor by a single pole thermostat.

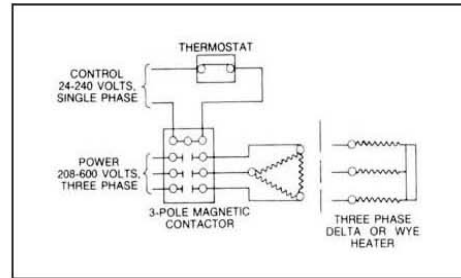

Fig. 3 Three phase heater controlled through a magnetic contactor by a single pole thermostat.

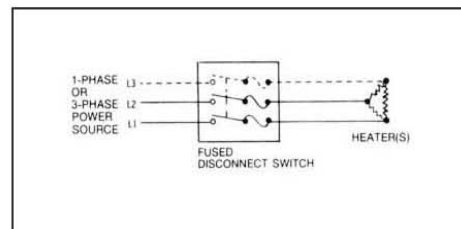

Fig. 4 Single phase a-c or d-c or 3-phase a-c heater circuit. Dotted lines and L3 indicates 3 phase.

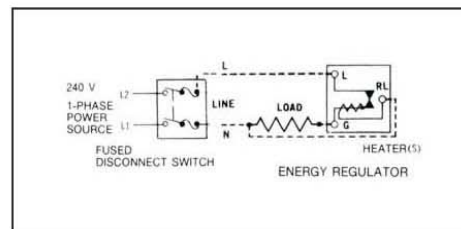

Fig. 5 Single phase a-c circuit with Type-TYJ energy regulator.

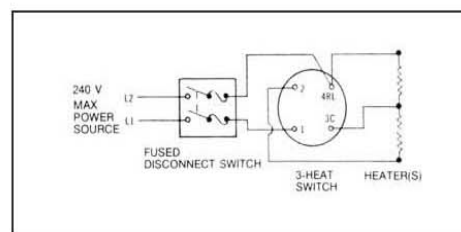

Fig. 6 Single phase a-c or d-c heater circuit with single-pole 3-heat switch.

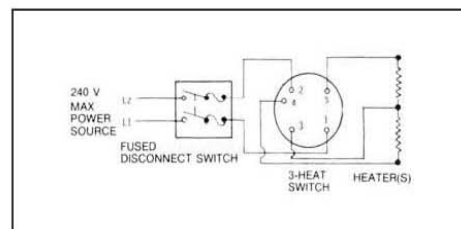

Fig. 7 Single phase a-c or d-c heater circuit with double-pole 3-heat switch.

Thermostat installation

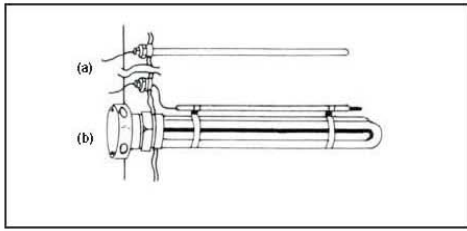

Fig. 8 Thermostat bulb installed in a tank:
a) in a well; b) adjacent to an immersion heater.

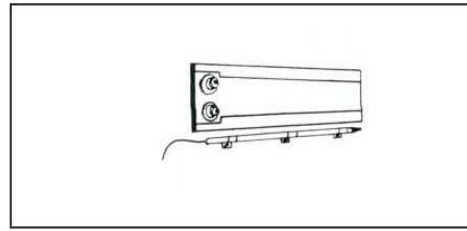

Fig. 9 Thermostat bulb clamped near strip or flat heater.

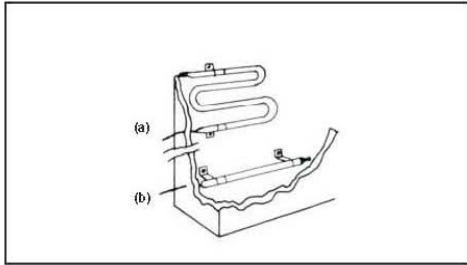

Fig. 10 Thermostat bulb installed in an oven:
a) bent; b) straight.

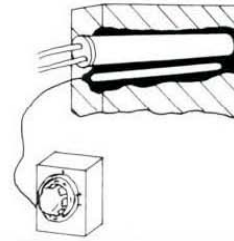

Fig. 11 Cartridge heater and thermostat bulb inserted into machined holes.

Installation

An improperly applied sensing bulb can give poor control even in a properly designed system. Following are some guidelines for various applications:

Solids - Proper bulb location depends on the demands of the system. If heat requirements are fairly steady, the bulb should be close to the heater - approximately 6mm away - unless the temperature at this point exceeds the maximum allowable bulb temperature. A good rule of thumb is that if the desired temperature at the work is more than ninety percent of the maximum control setting, the bulb should be further away - 12mm to 20mm.

If heat requirements are variable, the bulb should be close to the working surface to sense changes in demand quickly. However, since this location increases thermal lag between the bulb and heating elements, more undershoot and overshoot will occur. Closer control can be achieved by using a more sensitive instrument or multi-stage control.

Good contact between the bulb and machine part is essential. If surface mounted, it should be clamped down tightly but not deformed. If inserted in a machine hole, it should slip in with approximately 0.4mm diameter clearance.

Bulbs that are 5mm diameter and smaller may be bent as illustrated on a minimum radius of 12mm. However, 9.5mm bulbs should not be bent. If a bulb is crushed or pierced, causing it to lose its fill, it will be inoperative. Similarly, if the capillary is kinked or crushed, the control will not function.

Liquids - A liquid - tight joint must be made where the

bulb goes through a tank wall.

If the liquid will corrode the bulb, or if the liquid flow is such that the bulb must be supported over its entire length, a protective well should be used. Cat. No. 2374 and 2375 Thermostat Pocket.

Always install the bulb above the heater to sense the hot liquid. When heating a viscous liquid, the bulb should be close to the heater to prevent the liquid near the elements from overheating and carbonizing. When heating a light liquid such as water, bulb location is not critical.

Gases - Because gas temperatures can change more rapidly than most liquids and solids, it is always better to expose the thermostat bulb directly to the gas for quicker response. However, the bulb should not be exposed to radiation from the elements, as it will then sense a radiant temperature instead of the true gas temperature.

The bulb should not be installed close to a wall, which could be at a different temperature than the gas. The gas should circulate freely around the bulb.

When using an oven to heat a gas, it is always best to have the elements cover the full cross-sectional face of the oven and to have uniform air flowing across the face; otherwise, air temperatures may vary significantly from point to point. When variations are unavoidable, a thermostat should be selected with a long, sensitive bulb that can be woven back and forth across the face, sensing an average temperature.

RKC RIKA Electronic Controls

PN4 Series

Non-indicating Temperature Controllers (DIN)

72mm square non-indicating temperature controller designed for low cost and compactness. Solid state circuitry employs reliable component parts such as IC. Vibration and shock resistant construction.

The PN4 series is ideally suited for installation in small machines.

Cat No. PN-4A1C-M0400K



Standard Specifications

Operating principle	Potentiometric type
Input	CA(K), IC(J), PR10%(S), PR13%(R), Pt-100Ω
Setting accuracy	Within $\pm 1\%$ of full scale
Scale length	120mm
Control modes	On - Off, Time proportioning
Control output	Relay contact, DC voltage pulse
Thermocouple break protection circuit	Standard (only for thermocouple type)
	110/220V or
Power supply	120/240V AC, 50/60Hz (whichever specified)

Supply variation	Potentiometric type
Maximum external resistance	Up to 100Ω (Thermocouple type) Up to 10Ω (Resistance type)
Ambient temperature	-10 to +60°C (14 to 140°F)
Power consumption	5VA
Net weight	600g (1.3 lbs)
Dimensions	72 x 72 x 111mm (2.8 x 2.8 x 4.4 in.)

PF4 Series

Full Indicating Compact Temperature Controllers (DIN)

72mm square full indicating temperature controller. General-purpose controller which features:

- low cost • compact housing • easy operation.

The PF4 series is ideally suited for direction installation at small machines.

Cat No. PF-4A1C-M0200K, PF-4A1C-M0400K, PF-4A1C-M0800K



Standard Specifications

Operating principle	Potentiometric type
Input	CA(K), IC(J), PR10%(S), PR13%(R), Pt-100Ω
Setting accuracy	Within $\pm 2\%$ of full scale
Indicating accuracy	Within $\pm 2.5\%$ of full scale
Scale length	120mm
Control modes	On - Off, Time proportioning
Control output	Relay contact, DC voltage pulse
Thermocouple break protection circuit	Standard (only for thermocouple type)

Power supply	110/220V or 120/240V AC, 50/60Hz (whichever specified)
Supply variation	Potentiometric type
Maximum external resistance	Up to 100Ω (Thermocouple type) Up to 10Ω (Resistance type)
Ambient temperature	-10 to +60°C (14 to 140°F)
Power consumption	5VA
Net weight	600g (1.3 lbs)
Dimensions	72 x 72 x 111mm (2.8 x 2.8 x 4.4 in.)

Thermocouples

Cat No. U-TC-0039

Description: 3 to 4.8 mm S/S bulb with 2m braided lead type "K" thermocouple.

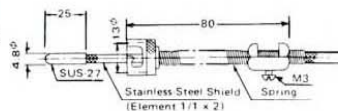

Desing Electrolux Macedonia

www.electroluxdesignlab.mk

+38947/203-330 ,203 900+389 2/329 8 130 www.electrolux.com.mk www.elektroluks.com.mk - electrolux@mt.net.mk



Air Heating Controls

Over temperature limit protection

To prevent heater failure which may result from accidental stoppage of air circulation, a thermal cut out device is installed in the heater in line with the air flow. The thermal cut out can be supplied with either manual or auto reset.

Manual Reset (capillary type)

Cat. No. 6010

Description:

Fixed set point over-temperature cut-out SPST contacts opening on temperature rise, temp 120°C.

Capillary length: 610mm (2mm dia.)

Electrical Rating:

100,000 Cycles	25 amperes non inductive 120-277 VAC
Manual Reset	125 VA, Pilot Duty 120-277 VAC

Complies with AS1668.1 and AS3102

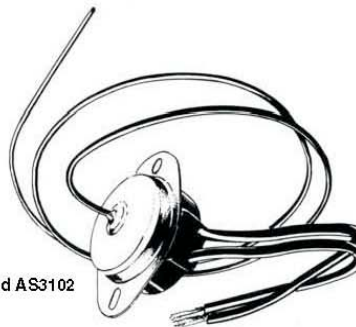

Auto Reset (contact type)

Cat. No. 6013

Description:

Fixed set point over-temperature cut-out SPST contacts opening on temperature rise. Open 87°C. Close 79°C.

The 6013 is a relatively small, versatile, low cost 3/4-inch bimetal disc temperature control, recognized by most of the world's testing agencies. It is used as a temperature limiting or regulating control for large electrical loads up to 25 amperes at 120/240VAC.



Fan/Heat Sequencer & Time Delay

Cat. No. 6055

Description:

The Cat. No. 6055 series Controls are field proven for controlling fans, heating elements in electrical furnaces, heat pumps, gas furnaces, central air conditioners, and many other applications including relays in control systems where a time delay is required. These products utilise the impact action of bimetal disc technology, powered by low wattage PTC (positive temperature coefficient) solid state heaters to operate the electrical switch contacts (24 volt bimetal).

The 6055 time delay relays are used as sequencers on electric heating products. this control has only one timing.

On time = 15-35 sec.

Off time = 25-55 sec.

* 24 V Transformers available on request.

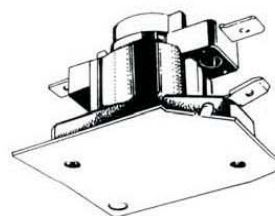

Representative Electrical Ratings				
Inductive Amperes		Resist. Amps		Volts AC
Full Load	Locked Rotor	Per Pole		
14.0	72.0	25.0	25.0	120
7.0	42.0	25.0	25.0	240
3.0	18.0	12.5	12.5	480

Desing Electrolux Macedonia

www.electroluxdesignlab.mk

+38947/203-330 ,203 900+389 2/329 8 130 www.electrolux.com.mk www.elektroluks.com.mk - electrolux@mt.net.mk



Custom Built Products

Stokes Synertec have the expertise to build, supply and install custom designed electrical heating solutions to suit most industry specifications.

Some of our custom projects have included:

- Tank Heaters
- Oil Storage Heaters
- Chemical Heaters
- Inline Circulation Heaters
- Large Air Heaters

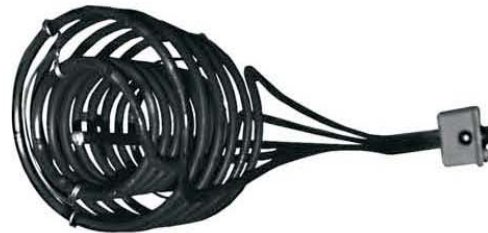

Tank Heaters



Large Oil Storage

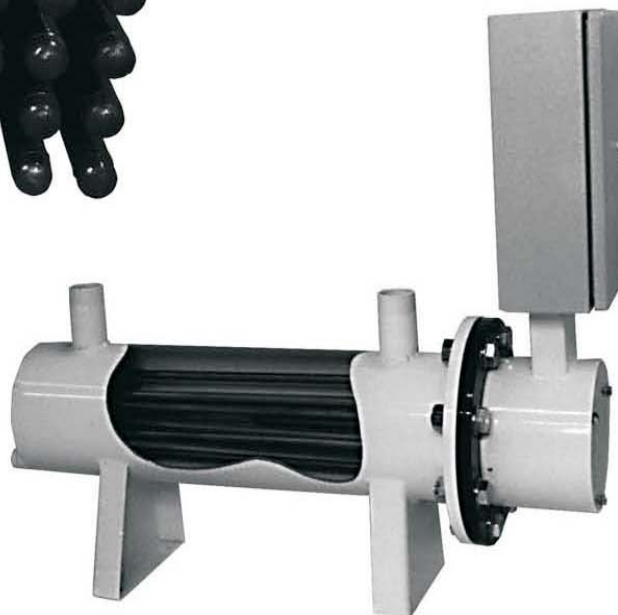

Inline Circulation Heaters

Desing Electrolux Macedonia
www.electroluxdesignlab.mk



Elektroluks is registered trademark of Elektroluks companies in Macedonia and other countries

Ovoj crtez e sposobnost na Elektroluks-Bez. negovo pisмено oobaruvanje istoi nesmee da se prepisuva, umnozuvaju ni ili kopira bez soglasnost od **Elektroluks** vo sprotno se snoset posledici vo smislana clenova 163 i 164 od kivilniot zakon R.M. (povreda na autorsko pravo)

Flame Proof Heaters

43

Electrolux now represents one of the world's leading manufacturers of flame proof heating systems, Caloritech Inc.

Whether you require heating systems for large flame proof steam boilers or small specialised immersion heaters, we can provide an effective solution to your needs.



Typical applications include:

- Oil Rigs
- Oil Refineries
- Petrochemical Refineries

For further information regarding flame proof electrical heating, contact Stokes Synertec.

Desing Electrolux Macedonia
www.electroluxdesignlab.mk

+38947/203-330 ,203 900+389 2/329 8 130 www.electrolux.com.mk www.elektroluks.com.mk - electrolux@mt.net.mk



Elektroluks is registered trademark of Elektroluks companies in Macedonia and other countries

Technical Section (specific heats and constants)

Substance	Specific Heat	Heat of Fusion BTU/LB	Melting Point		Weight in LB/ Cu.Ft.
			(°C)	(° F)	
Aluminium	0.23	138	657	1216	160
Antimony	0.052	25	630	1166	423
Asphalt	0.4	40	125±	250±	65
Beeswax	-	75	68	144	60
Bismuth	0.031	23	270	520	610
Brass	0.1	-	938±	1700±	525
Brickwork and Masonry	0.22	-	-	-	140
Carbon	0.204	-	-	-	-
Copper	0.1	75	1083	1981	550
Glass	0.2	-	1204±	2200±	165
Graphite	0.2	-	-	-	130
Iron, Cast	0.13	-	1260±	2300±	450
Iron, m Wrought	0.12	-	1538±	2800±	480
Lead, Solid	0.031	10	924	621	710
Lead, Melted	0.04	-	-	-	-
Nickel	0.11	-	1450	2642	550
Paper	0.45	-	-	-	58
Paraffin	0.7	63	50	133	56
Pitch, hard	-	-	150±	300±	83
Rubber	0.4	-	-	-	95±
Silver	0.057	38	960	1761	655
Solder (50% lead - 50% tin)	0.04	17	210	415	580
Steel	0.12	-	1390	2550±	490
Sugar	0.3	-	160	320	105
Sulphur	0.203	17	221	230	125
Tallow	-	-	32±	90±	60
Tin, solid	0.056	25	232	450	455
Tin, melted	0.064	-	-	-	-
Type metal (85% lead - 15% antimony)	0.04	-	260	500	670
Wood	.450+	-	-	-	34-pine
Wood	.450+	-	-	-	50-oak
Zinc	0.095	51	420	787	445

Product	Specific Heat	Approx. Weight in LB. Per Cu. Ft. at S.T.P.
Acetylene	0.35	0.073
Air	0.237	0.08
Alcohol	0.453	-
Amonia	0.52	0.048
Argon	0.124	0.1037
Carbon Dioxide	0.203	0.123
Carbon Monoxide	0.243	0.078
Chlorine	0.125	0.2
Ethylene	0.4	0.0728
Helium	1.25	0.0104
Hydrochloric Acid	0.195	0.102
Hydrogen	3.41	0.0056
Methane	0.6	0.0447
Methyl Chloride	0.24	0.1309
Nitric Oxide	0.231	0.0779
Nitrogen	0.245	0.078
Oxygen	0.218	0.09
Sulphur Dioxide	0.155	0.179

Material	Average Specific Heat	Heat of Vaporisation BTU per LB.	Boiling Point		Weight in LB. per Cubic per Imp.	
			(°C)	(° F)	Ft.	Gal.
Ethylene Glycol	0.602	-	195	387	70.5	11.2
Fish Oil	-	-	-	-	53	9.3
Fuel Oil - Bunker C	0.5	145-150	-	-	61	9.6
Gasolene	0.675	137	86-90	158-194	48.6	7.7
Glue 1/8 Conc.	0.895	-	-	-	69	11
Glycerine	0.58	-	290	554	79	12.7
Kerosene	0.47	108	-	-	51.5	8.24
Mercury	0.0333	117	357	675	84.5	135.56
Milk	1.0(app.)	-	-	-	64.5	10.3
Molasses	0.6	-	-	-	87.4	14
Oil - Cottonseed	0.47	-	-	-	60	9.3
Oil - Machine	0.4	-	-	-	58	9.31
Oil - Olive	0.471	-	300+	570+	58	9.3
Paraffin - Melted	0.71	-	400+	750+	56	8.99
Petroleum	0.51	-	-	-	56	8.99
Sulphur - Melted	0.234	652	315	601	-	-
Turpentine	0.41	133	160	319	54	8.66
Water	1	965	100	212	62.5	10.01



Technical Section (suggested maximum watts density ratings)

MATERIALS BEING HEATED	Maximum Operating Temp.		Maximum Watts per		
	°C	(°F)	sq. cm	(sq.in)	
Acid Solution or Electro-Plating Tanks	82	180	6.2	40	
Alkali and Oakite Cleaning Solution	100	212	6.2	40	
Asphalt, Tar, Heavy Compounds, etc.	95	200	1.55	10	
	150	300	1.24	8	
	205	400	1.08	7	
	280	500	0.93	6	
	70	160	1.55	10	
Bunker C Fuel Oil	70	160	1.55	10	
Casutic Soda	2%	98	212	6.97	45
	10%	98	212	3.87	25
	75%	82	180	3.87	25
Dowtherm A -					
Liquid phase	400	750	2.97	18	
Vapour phase	400	750	1.86	12	
Dowtherm E	205	400	1.86	12	
Ethylene Glycol	150	300	4.65	30	
Freon	150	300	4.65	3	
Fuel Oil Pre-heating	82	180	1.4	9	
Gasoline, Kerosene	150	300	0.543	3.5	
Glue	Heat indirectly using water bath				
Lead-Stereotype Pot	315	600	5.42	35 on casting	
Liquid Ammonia Plating Baths	10	50	3.87	25	
Machine Oil. SAE-30	120	250	2.97	18	
Metal Melting Pot	260-480	500-900	3.1-4.18	20-27	
Mineral Oil	95	200	3.1	20	
	205	400	2.48	160	
Molasses	38	100	.62-.775	4-5	
Molten Salt Bath	430-510	800-950	3.87-4.65	25-30	
Molten Tin	315	600	3.1	20	
Oil Draw Bath	315	600	3.1	20	
	205	400	3.72	24	
Paraffin or Wax	77	150	2.48	16	
Sodium Cyanide	59	140	6.2	40	
Steel Tubing Cast into Aluminium	260-400	500-750	7.75	50	
Steel Tubing Cast into Iron	400-540	750-1000	8.52	55	
Socony Vacuum Type Transfer Oil	315	600	3.1	20	
Therminols and Heat Transfer Oils	260	500	3.1	20	
	315	600	3.1	20	
	345	650	2.32	15	
Trichlorethylene	77	150	3.1	20	
Vapour Degreasing Solutions	135	275	3.1	20	
Vegetable Oil (fry kettle)	205	400	3.1	30	
Water (process)	100	212	7.75	50	
Water (washroom)	59	140	12.4-13.95	80-90	

These watt densities may be adjusted when heat take-away or flow velocities are increased, or when heat operating temperatures are altered.

Therefore; watts, density ratings of gases, and to a large degree liquids, are dependent on the flow velocity and initial temperature of the product.

Visit www.stokessynertec.com for an online Ohm's Law Calculator.

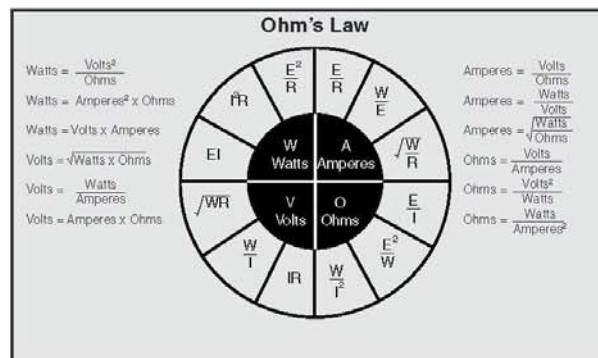

Technical Section (Conversion Factors)

Visit www.stokessynertec.com for an online Unit Conversion Calculator.

LENGTH

Millimetres (mm)	Metres (m)	Inches (in)	Feet (ft)
1	10 ⁻³	0.03937	0.00328
10 ³	1	39.37	3.28
25.4	0.0254	1	0.0833
304.8	0.3048	12	1

AREA

Square Millimetres (mm ²)	Square Metres (m ²)	Square Inches (in ²)	Square feet (ft ²)
1	10 ⁻⁶	1.55x10 ⁻³	0.01076x10 ⁻³
10 ⁶	1	1550	10.764
645.16	0.645x10 ⁻³	1	6.949x10 ⁻³
92.903x10 ⁻³	0.0929	144	1

MASS

Kilogram (kg)	Metric Ton (tonne 1000kg)	Pound (lb)	UK Ton (ton)
1	10 ⁻³	2.205	0.984x10 ⁻³
10 ³	1	2205	0.984
0.454	0.454x10 ⁻³	1	0.461x10 ⁻³
1016	1.016	2240	1

VOLUME

Cubic Millimetres (mm ³)	Cubic Metres (m ³)	litre (litre)	Cubic Inches (in ³)	Cubic Feet (ft ³)	Imperial gallon (gal)
1	10.9	10 ⁻⁶	61.023	0.353x10 ⁻⁹	0.220x10 ⁻⁹
10 ⁹	1	10 ³	61.023x10 ³	35.315	219.9
10 ⁶	10 ³	1	61.023	0.035	0.022
16.4x10 ⁻³	16.4x10 ⁻⁶	16.4x10 ⁻³	1	0.57x10 ⁻³	3.6x10 ⁻³
28.32x10 ³	0.0283	28.316	1728	1	6.229
4546x10 ³	0.0045	4.546	277.46	0.1605	1

POWER

Kilowatt (kW)	British Thermal (Btu)
1	3412
0.293x10 ⁻³	1

WATT DENSITY

Watt per square inch (watt/in ²)	Kilowatt per Square Metre (kw.m ²)
1	1.55
0.645	1

SPECIFIC HEAT CAPACITY

Btu/lb.°F	J/kg.K	Kj/Kg.K
F	K	K
1	4.187x10.3	4.187
238.8	1	10.3
0.2388	10.3	1

Note: 1 Cal=4.187J

VOLUME RATE OF FLOW

Cubic Foot per Second (ft ³ /s)	Cubic foot per Minute (ft ³ /min)	Litres per Second (litres/s)	Gallons per Minute (gal/min)	Cubic Metres per Second (m ³ /s)	Cubic Metres per Minute (m ³ /min)
1	60	28.316	373.2	0.028	1.68
0.016	1	0.472	6.229	0.47x10 ⁻³	0.0283
0.035	2.119	1	13.2	1x10 ⁻³	60x10 ⁻³
0.003	0.1605	0.076	1	0.076x10 ⁻³	4.56x10 ⁻³
35.315	2119	1x10 ³	13.19x10 ³	1	60
0.588	35.315	16.6	219.9	0.016	1

ENERGY

British Thermal Unit (Btu)	Kilojoule (kj)
1	1.06
0.0948	1



Electrolux-Palenzo

Innovation by design

