



Spare parts suitable for: MARENO

Spare parts suitable for modular ranges



Spare parts suitable for hot-air ovens and combination steamers

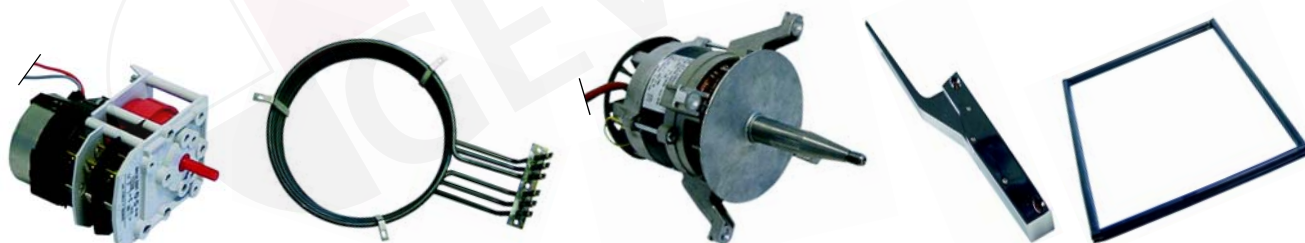

Spare parts suitable for small appliances and single devices



G.E.V. Großküchen-Ersatzteil-Vertrieb GmbH
Robert-Koch-Straße 3a
82152 Planegg/Munich
Germany

Phone: +49 (0)89 745572-0
Fax: +49 (0)89 745572-83
order@gev-online.com
www.gev-online.com

Member of the  **GEV GROUP**

TABLE OF CONTENTS

Open tops (gas/electric)



page 4

Ovens (gas/electric)



page 11

Fry tops (gas/electric)

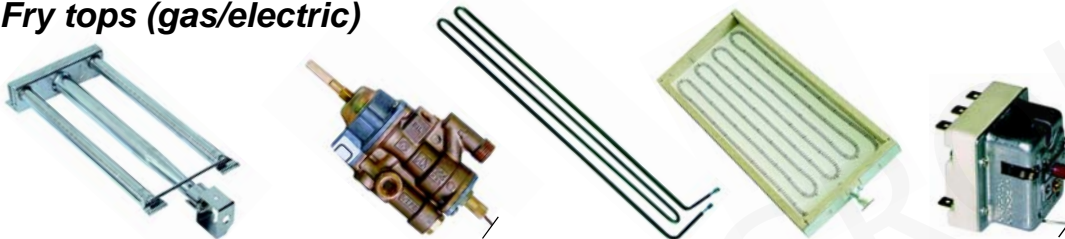

page 15

Lava rock grills (gas)

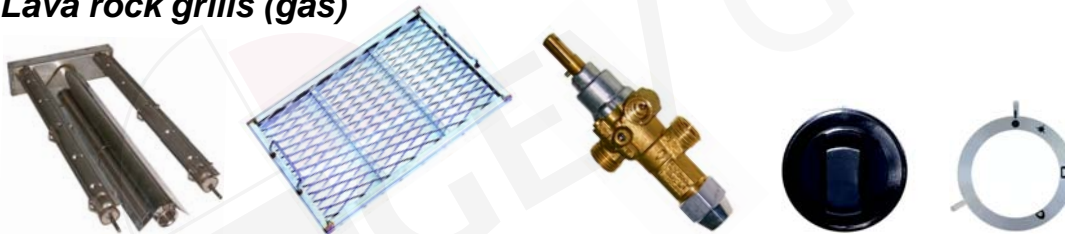

page 19

Chargrills (electric), bratt pans/boiling brasses (gas/electric)



page 19

Pasta cookers (gas/electric)

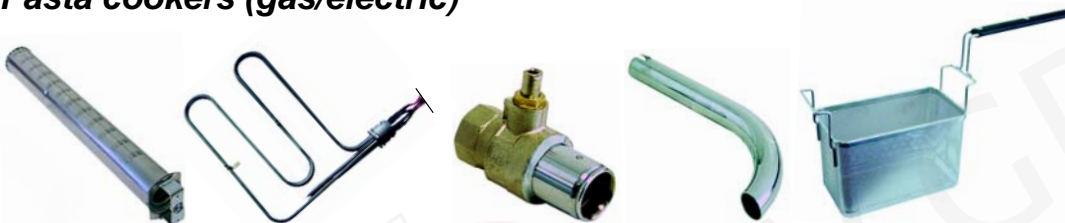

page 22

TABLE OF CONTENTS

Bains-marie (gas/electric)



page 26

Chip scuttles (electric), fryers (gas/electric)



page 30

Tilting bratt pans (gas/electric)

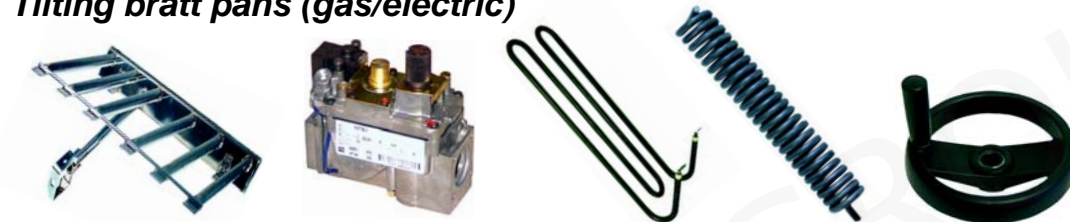

page 36

Boiling pans (gas/electric)



page 41

Hot-air ovens/combination steamers (gas/electric)



page 48

Small appliances and single devices



page 52

M

Open tops (gas)



Item	Order	Description	Model	OEM
1	103066	burner cover, 80mm		10.32000700
2	103065	burner ring	PCG40/60/100 KCF6G	10.32009500
3	104100	burner base	CFG60	10.32009300
4	104101	jet holder		10.32009100



Item	Order	Description	Model	OEM
1	103068	burner cover, 100mm		10.32000800
2	103067	burner ring	PCG40/60/100 KCF6G	10.32009600
3	104102	burner base	CFG60	10.32009400
4	104103	jet holder		10.32009200

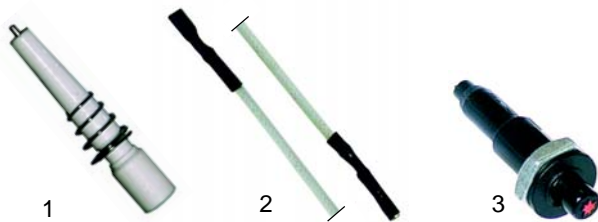

Item	Order	Description	Model	OEM
1	100729	electrode		10.31025600 10.47024200
2	100197	ignition cable, 600mm	PCG40/60/100 KCF6G	10.47024300
3	100013	piezoelectric igniter		10.31500600

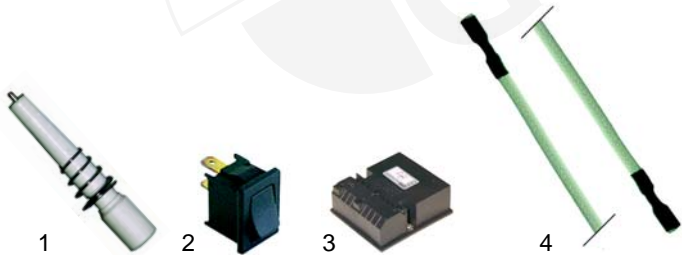

Item	Order	Description	Model	OEM
1	100729	electrode		10.31025600
2	345314	ignition switches		10.37102500
3	101003	ignition unit	LFGE60	10.37301400
4	100036	ignition cable, 500mm		10.47102900
4	100037	ignition cable, 1000mm		10.47103000

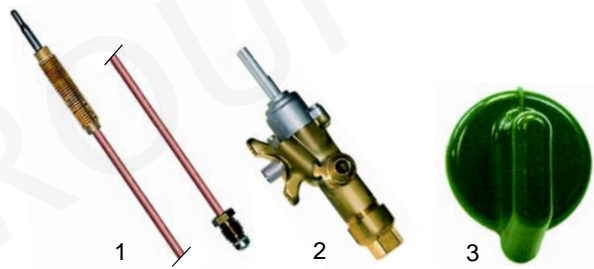

Item	Order	Description	Model	OEM
1	102054	thermocouple, 320mm		10.33027100
1	102056	thermocouple, 600mm		10.33027200
2	101154	gas tap	PCG40/60/100 KCF6G CFG60	10.31028200 10.31028300
3	110406	knob		10.36700300 10.31018700



Item	Order	Description	Model	OEM
1	103143	burner cover 3,5kW		10.32501400
2	103140	burner base 3,5kW		10.32101400
3	103146	Venturi	PCG41/61 PCGD41/61	10.32101200
4	103148	gasket	CFG70/101	10.36607800
5	105230	jet rod		10.33717200



Item	Order	Description	Model	OEM
1	n.l.a.	burner cover, 5,5kW		10.32501600
2	n.l.a.	burner base, 5,5kW		10.32101500
3	103147	Venturi	PCG41/61 PCGD41/61	10.32101300
4	103149	gasket	CFG70/101	10.36607900
5	105230	jet rod		10.33717200



Item	Order	Description	Model	OEM
1	103145	burner cover, 5,5kW		10.32501500
2	103142	burner base, 5,5kW		10.32101600
3	103147	Venturi	PCG41/61 PCGD41/61	10.32101300
4	103149	gasket	CFG70/101	10.36607900
5	105230	jet rod		10.33717200



Item	Order	Description	Model	OEM
1	100082	pilot burner	PCG41/61	10.32501300
2	101860	nut M10x1	PCGD41/61	10.33514900
3	100834	mushroom cap	CFG70/101	10.33717300



Item	Order	Description	Model	OEM
1	101096	gas tap CH110001	704,706, TPF706S,	932500
2	110064	knob	CC_GS, CF_GS,	932600
3	110066	pin	CA4GS, TPF6GS (very old model)	932700



Item	Order	Description	Model	OEM
1	102034	thermocouple, 600mm	PCG41/61	1206400
2	101693	gas tap	PCGD41/61 CFG70/101	10.31500200 10.31501300
3	110405	knob		10.36700500



Item	Order	Description	Model	OEM
1	103020	burner cover, 80mm		1315600 1315612
2	104030	burner base	C70-_G/GFG/GFE C9V-_G/GS C9F-_G/GS	1315412 1315422
3	104033	Venturi	C9SB-4GS T9-_GS	1315200 1315212
4	105051	aeration sleeve	C9FE-_GS (1.+2.generation)	1314700
5	105052	jet rod		1306400 1306600

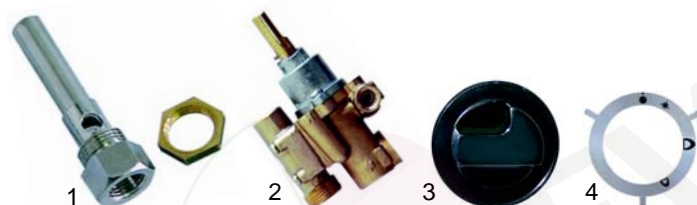

Item	Order	Description	Model	OEM
1	100089	pilot burner	704, 706, TPF706, 704S, 706S, TPF706S, CC_G, CF_GT, CA4G, TPF6GT	432600
2	101443	gas tap PEL without safety pilot	704,706, TPF706, CC_G, CF_GT, CA4G, TPF6GT	673800
3	110364	knob		862800
4	110601	symbol		



Item	Order	Description	Model	OEM
1	103021	burner cover, 110mm	C70-G/GFG/GFE*,	1315700
2	104031	burner base	C9V-_G/GS*,	1315512
3	104034	Venturi	C9F-_G/GS, C9SB-4GS*,	1315312
4	105051	aeration sleeve	T9-_GS*	1314700
5	105052	jet rod	* 1.generation	1306400



Item	Order	Description	Model	OEM
1	102054	thermocouple 320mm		641400
1	102056	thermocouple 600mm	704,706, TPF706S,	641300
2	101089	gas tap PEL with safety pilot	CC_GS, CF_GS,	1093600 1093700
3	110364	knob	CA4GS, TPF6GS	862800
4	110601	symbol		



Item	Order	Description	Model	OEM
1	103021	burner cover, 110mm	C70-G/GFG/GFE*,	1315712
2	104031	burner base	C9V-_G/GS*,	1315522
3	103151	burner ring	C9F-_G/GS, C9SB-4GS*,	1893300
4	103150	Venturi	T9-_GS*,	1892500
5	105051	aeration sleeve	C9FE-_GS	1314700
6	105052	jet rod	* 2. generation	1306600



Item	Order	Description	Model	OEM
1	103022	burner cover, 120mm	C9V-_G/GS*	1316000
2	104032	burner base	C9F-_G/GS*, C9SB-_4G/GS*	1315912
3	104035	Venturi	T9-_G/GS*	1315800
4	105051	aeration sleeve	* 1. generation	1314700
5	105052	jet rod		1306600



Item	Order	Description	Model	OEM
1	103022	burner cover, 120mm	C9V-_G/GS*	1316012
2	104032	burner base	C9F-_G/GS*, C9SB-_4G/GS*	1315922
3	103150	Venturi	T9-_G/GS*	1315812
4	105051	aeration sleeve	* 2. generation	1314700
5	105052	jet rod		1306600

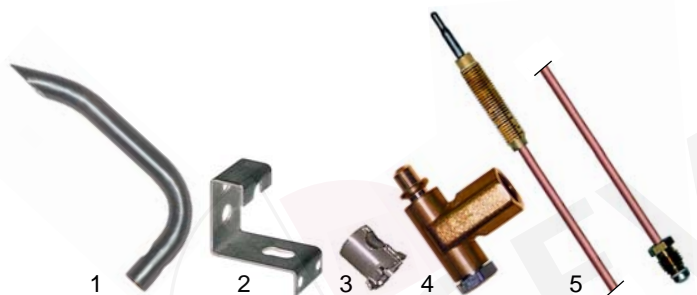

Item	Order	Description	Model	OEM
1	100838	ignition line		1314600
2	100890	holder		1706100
3	100885	aeration sleeve	universal,	1324900
4	100883	pilot burner	1. generation	1314800
5	102054	thermocouple, 320mm		641400
5	102056	thermocouple, 600mm		641300



Item	Order	Description	Model	OEM
1	101095	gas tap PEL21	C70-_G, C70-_GFG,	1700200
2	110363	knob	C70-_GFE	1623300
3	110601	symbol	* 1. generation	



Item	Order	Description	Model	OEM
1	101443	gas tap PEL22, without ignition flame	C9-_G 1. generation	1337600
2	101089	gas tap PEL22, with ignition flame	C9-_GS 1. generation	1337200
3	110388	knob	C9-_G, C9-_GS	1322400
4	110620	symbol		



Item	Order	Description	Model	OEM
1	100095	pilot burner		1887700
2	100701	electrode	universal,	1888300
3	100019	ignition cable	2. generation	1950300
4	100009	piezoelectric igniter		1936100
5	102042	thermocouple, 850mm		1916000



Item	Order	Description	Model	OEM
1	101397	gas tap PEL21	C70-, C9_- 2. generation	1888700 1888800 1888900
2	110363	knob	C70-	1841000
3	110601	symbol	2. generation	
4	110387	knob	C9_-	1893500
5	110620	symbol	2. generation	



Item	Order	Description	Model	OEM
1	105248	burner cover, 3,5kW		CM264200 1032501422
2	105249	burner base	C7-_GS, C7FG-_GS,	CM264000
3	103146	Venturi	C7FE-_GS	1032101200
4	103148	gasket	(Predagonista)	1036607800
5	105230	jet rod		1033717200
6	105336	aeration sleeve		1044229212



Item	Order	Description	Model	OEM
1	105259	burner cover, 5,5kW		1032501622 CM264300
2	105262	burner base	C7-_GS, C7FG-_GS, C7FE-_GS	CM264100
3	103147	Venturi	(Predagonista)	1032101300
4	103149	gasket		1036607900
5	105230	jet rod		1033717200
6	105336	aeration sleeve		1044229212



Item	Order	Description	Model	OEM
1	105268	burner cover, 110mm	C7-_G, C7FG-_G, C7-FE-_G,	CM027100
2	105269	burner base	C9-_G/GS, C9FE-_G/GS,	CM005901
3	105272	Venturi	C9-_GP,	CM043000
4	105267	jet rod	C9FGM-12G	1711800
5	105051	aeration sleeve		1314700



Item	Order	Description	Model	OEM
1	100082	pilot burner	C7-_GS, C7FG-_GS, C7FE-_GS	1032501300
2	101860	nut, M8x1	(Predagonista)	1032514900
3	100834	mushroom cap		1033717300



Item	Order	Description	Model	OEM
1	105273	burner cover, 120mm	C7-_G, C7FG-_G, C7-FE-_G,	CM027200
2	105274	burner base	C9-_G/GS, C9FE-_G/GS,	CM006502
3	105275	Venturi	C9-_GP,	CM043100
4	105267	jet rod	C9FGM-12G	1711800
5	105051	aeration sleeve		1314700



Item	Order	Description	Model	OEM
1	102042	thermocouple, 850mm	C7-_GS, C7FE-_GS, C7FE-_GS	1916000
2	101397	gas tap	(Predagonista)	1888700
3	110894	knob		CM061700



Item	Order	Description	Model	OEM
1	100095	pilot burner	C7-_G, C7FG-_G, C7-FE-_G,	1887700
2	100701	electrode	C9-_G/GS, C9FE-_G/GS,	1888300
3	100195	ignition cable	C9-_GP,	1950324
4	100009	piezoelectric igniter	C9FGM-12G	1936100



Item	Order	Description	Model	OEM
1	105263	burner cover, 80mm	C7-_G, C7FG-_G, C7-FE-_G,	CM027600
2	105265	burner base	C9-_G/GS, C9FE-_G/GS,	CM006001
3	105266	Venturi	C9-_GP,	CM042900
4	105267	jet rod	C9FGM-12G	1781800
5	105051	aeration sleeve		1314700



Item	Order	Description	Model	OEM
1	102042	thermocouple, 850mm	C7-_G, C7FG-_G, C7-FE-_G,	1916000
2	101397	gas tap	C9-_G/GS, C9FE-_G/GS, C9-_GP,	1888700 1888800 1888900
3	110894	knob	C9FGM-12G	CM061700

Open tops (solid tops)



Item	Order	Description	Model	OEM
1	105042	burner cover	T70___, T9V___, T9F___, T7___, T9___	1315000 1316400
2	105041	burner base	T70___, T9V___, T9F___	1316300
3	105484	burner base	T9___ (Predagonista)	CM0005004

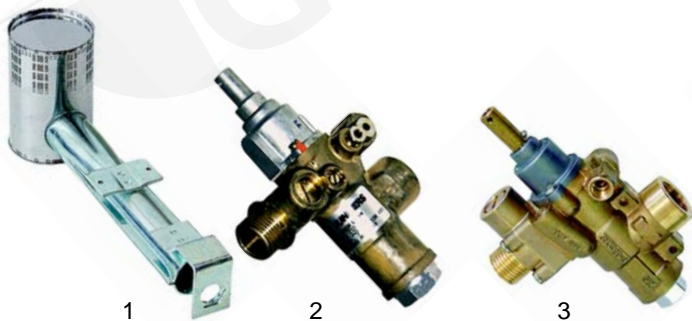

Item	Order	Description	Model	OEM
1	105485	burner	T7___ (Predagonista)	CM002900
2	n. l. a.	gas tap, CH330		745700
3	101630	gas tap, PEL23, alternative	TPF___GT/GS, TPF706	745700

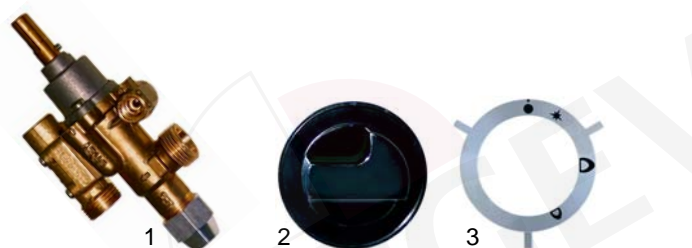

Item	Order	Description	Model	OEM
1	101086	gas tap PEL22	T70-7G, T70-7GFG,	1337200
2	110364	knob	T70-11GFG	1842000
3	110601	symbol	(old series)	1842000



Item	Best.ell-Nr.	Description	Model	OEM
1	101093	gas tap PEL23	T9F-4G/6GS,	1345300
2	110388	knob	T9V-4G/6GS (old series)	1322200
3	110620	symbol		1322300



Item	Order	Description	Model	OEM
1	101089	gas tap PEL22	T70-7G, T70-7GFG,	1888600
2	110364	knob	T70-11GFG, T9V-4G, T9F-4G/6GS	1840900
3	110601	symbol	(new series)	1842000



Item	Order	Description	Model	OEM
1	101089	gas tap	T7-___, T9-___, T12-___	1888600
2	110993	knob	(series Predagonista)	CM061600



Item	Order	Description	Model	OEM
1	100073	pilot burner		509900
2	100703	electrode		636700
3	102227	thermocouple, 600mm	TPF-706, TPF-GT/GS	641600
4	100007	piezoelectric igniter	(until Nr. 150981)	224311
5	100026	ignition cable		548300



Item	Order	Description	Model	OEM
1	100046	pilot burner	TPF-___GT/GS	1040511
2	100706	electrode	(from Nr. 160981), T70-7G/GGFG,	224211
3	102041	thermocouple, 600mm	T70-11GFG, T9F4G/GS, T9V-4G/GS	90520



Item	Order	Description	Model	OEM
1	102011	extension, 400mm	T9-4G/GS, T9V-4G/GS, TPF-__GT/GS (from Nr. 160981)	933400
2	100003	piezoelectric igniter	TPF-__GT/GS (from Nr. 160981),	986000
3	100199	ignition cable	T70-7G/GGFG, T70-11GFG, T9F4G/GS, T9V-4G/GS	1152500 1152600 1088900



Item	Order	Description	Model	OEM
1	100859	pilot burner		1887700
2	100701	electrode	T70-7G/GFG, T70-11GFG,	1888300
3	102042	thermocouple, 850mm	T9F-4G/6GS, T9V-4G/6G	1916000
4	100009	piezoelectric igniter		1936100
5	100186	ignition cable	T70-series	1936300
6	100019	ignition cable	T9F/T9V-series	1936400



Item	Order	Description	Model	OEM
1	100050	pilot burner		CM029000
2	100701	electrode		1949900
3	102042	thermocouple, 850mm	T7-__, T9-__, T12-__ (series Predagonista)	CM029100
4	100009	piezoelectric igniter		1936100
5	100186	ignition cable		1936300

Open tops (electric)

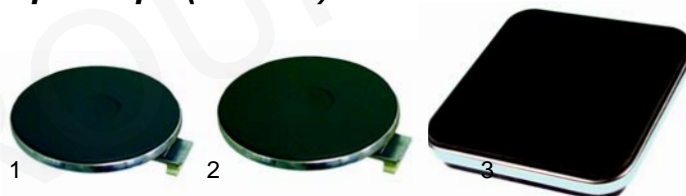

Item	Order	Description	Model	OEM
1	490014	1500W/230V (180mm)	PCE-__, CFE-__, C70-__E, C70-__EFE	1037040900 1037044000 1641600 1839813
2	490018	2000W/230V (220mm)		1037079100 1037043900 1647013 1641500
2	490020	2600W/230V (220mm)	C70-__E/EFE, C7-__EC, C7FE-8E/EC	1832313
3	490066	2600W/230V (220x220mm)	C70-__EFEQ	1712913

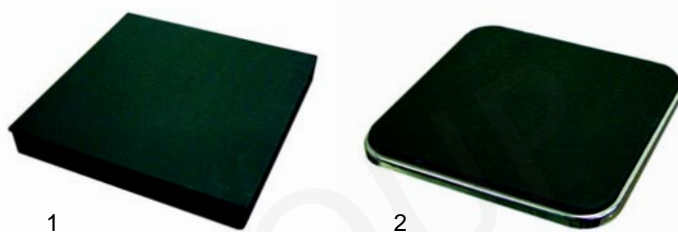

Item	Order	Description	Model	OEM
1	490088	2500W/400V (300x300mm)	CF-__E, CC-__E, CA-__E	279111
1	490090	4000W/400V (300x300mm)		783700
2	490070	3000W/230V (300x300mm)	C9V-__E, C9F-__E,	1937100 1340800
2	490071	4000W/230V (300x300mm)	C9-__E/EC, C9FE-8E/EC	1937300 1340900
2	490073	3000W/400V (300x300mm)	C9V-__E, C9F-__E, C9-__E/EC, C9FE-8E/EC	1937200
2	490074	4000W/400V (300x300mm)		1937400

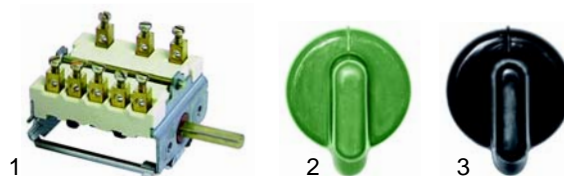

Item	Order	Description	Model	OEM
1	300025	7-position switch	PCE-__, CFE-__, C70-E/EFE/EFEQ, C9V-__E (400V plate), C9F-__E, C7-__EC, C7FE8E/EC, C9-__E/EC, C9FE8E/EC	1037033100 1616100
2	110405	knob		1036700500
3	110408	knob	PCE-__, CFE-__	1036702200

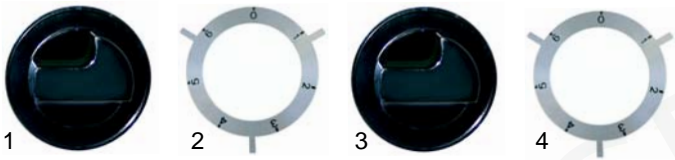

Item	Order	Description	Model	OEM
1	110362	knob	PCE, CFE	1036700900
2	110606	symbol		1039107300
3	110360	knob	C70-__E/EFE/EFEQ	18407000
4	110606	symbol		18402000

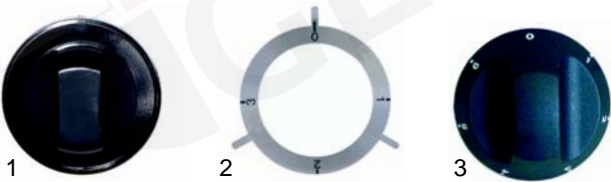

Item	Order	Description	Model	OEM
1	110386	knob	C9V-__E (400 V plate), C9F-__E (400 V plate)	1508100
2	110626	symbol		1322700
3	110994	knob	C7-__EC, C7FE8E/EC, C9-__E/EC, C9FE8E/EC	CM062100



Item	Order	Description	Model	OEM
1	300103	4-position switch	CA-__E, CC-__E, CF-__E, C9V-__E (230 V plate), C9F-__E (230 V plate)	501400
2	110386	knob		1508100
3	110626	symbol		1322700



Item	Order	Description	Model	OEM
1	359159	signal lamp/yellow	CA-__E, CC-__E, CF-__E, C9V-__E, C9F-__E	912800
2	359139	signal lamp/green	PCE__, CFE__	1037300800 1037300810
3	359140	signal lamp/yellow	C7-__EC, C7FE8E/ EC, C9-__EC, C9FE8E/EC	1037300910
4	359142	signal lamp/green	C70-__E/EFE/EFEQ	21016199
5	359143	signal lamp/yellow	C9V-__E, C9F-__E	1819900

Open tops (ceramic hobs)

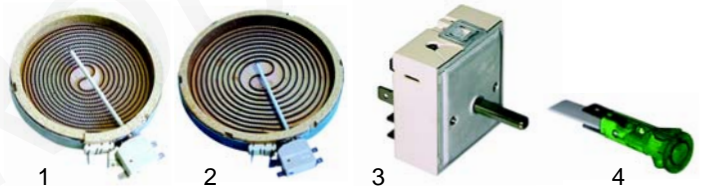

Item	Order	Description	Model	OEM
1	490116	1200W/230V		1037309600 1037309613
2	490113	1800W/230V	PCVE-__, CFVE-60	1037309000 1037309013
3	380015	energy regulator		1037110113
4	359139	signal lamp		1037300810

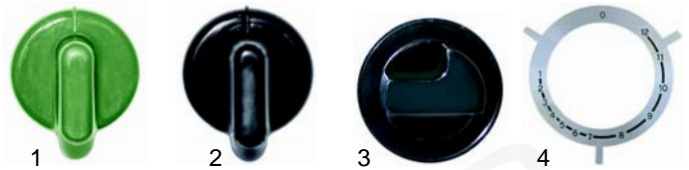

Item	Order	Description	Model	OEM
1	110405	knob		1036700500
2	110408	knob		1036702200
3	110362	knob	PCVE-__, CFVE-__	1036700900
4	110608	symbol		1039115600

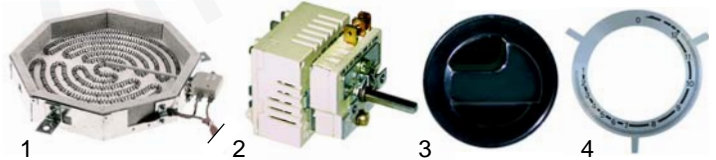

Item	Order	Description	Model	OEM
1	416963	2400W/230V		1037308900 CR0419950
2	380016	energy regulator (50.27021.600)	PCVE-__, CFVE-__	1037108713
3	110362	knob		1036700900
4	110609	symbol		1039115700

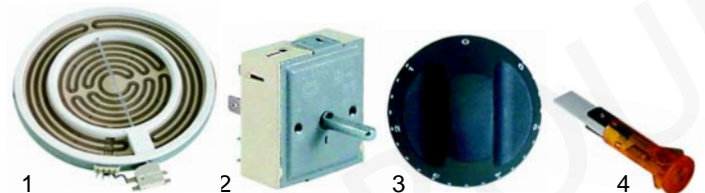

Item	Order	Description	Model	OEM
1	490115	3400W/230V		CM189500
2	380027	energy regulator	V9-4E, V9-8E	CM189600 CM293900
3	110995	knob		CM062500
4	359140	signal lamp		1037300910

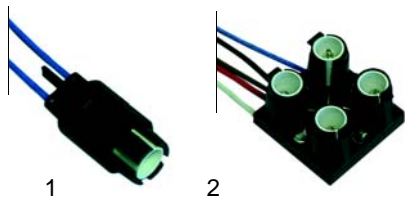

Item	Order	Description	Model	OEM
1	359327	residual temperature display, 1-compartment	universal	1037309300 1037309310
2	359326	residual temperature display, 4-compartment		1037309400

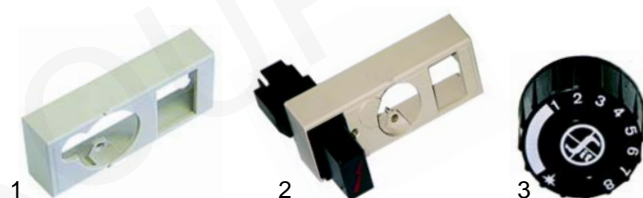

Item	Order	Description	Model	OEM
1	101137	cover		24020199
2	101136	cover with piezoelectric igniter	CF-__GT/GS	24020299
3	110068	knob		24020399

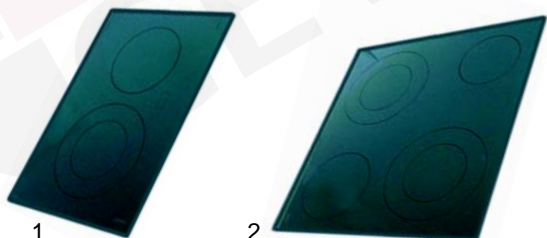

Item	Order	Description	Model	OEM
1	693116	ceramic hob (510x348 mm)	PCVE-40	1041711623
2	693117	ceramic hob (510x548 mm)	PCVE-60	1041711723



Item	Order	Description	Model	OEM
1	100007	piezoelectric igniter		224311
2	100003	piezoelectric igniter	CF-__GT/GS	986000
3	100001	piezoelectric igniter		

Ovens (gas)



Item	Order	Description	Model	OEM
1	105486	burner	CFG-__, C70-__GFG, T70-__GFG	1664300
2	105487	burner	C9F-__, C9FP-__, T9F-__, T9FP-__	1305024
3	105488	burner	C__FG-__G, C9FG-8GP, T__FG-__G	CM021402



Item	Order	Description	Model	OEM
1	101173	gas thermostat		1661300 1699400 CFG-__, 1031500000
2	110406	knob	C70-__GFG, T70-__GFG	1036700300
3	110361	knob		1036703300
4	110603	symbol		1930400

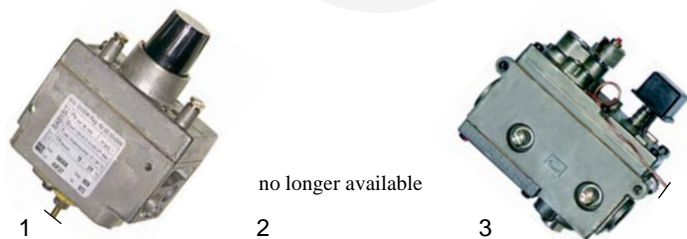

Item	Order	Description	Model	OEM
1	101105	Babysit controller	704, 704S, 706, 706S/AS, TPF706/706S	508311 24020599
2	n. l. a.	knob		
3	101132	Minisit controller	CF-__GT/GS	410622 671111



Item	Order	Description	Model	OEM
1	101132	Minisit controller		1393100 1307200
2	101136	cover with piezoelectric igniter	C9F-__G/GS, T9F-4G/GS	1393600
3	110068	knob		1393500
4	100003	piezoelectric igniter		986000

M

Suitable for Mareno



Item	Order	Description	Model	OEM
1	101125	Eurosit controller		1887600
2	101392	adapter	C9F-__, C9FP-__	1868600
3	101390	axis	T9F-__, T9FP-__	1905525
4	110386	knob	T9FP-__	1508100
5	110623	symbol		1889800



Item	Order	Description	Model	OEM
1	100106	pilot burner		1315100
2	100706	electrode	C9F-__G/GS, T9F-__G/GS	224211
3	102041	thermocouple		90520
4	102011	extension, 400mm		933400



Item	Order	Description	Model	OEM
1	101125	Eurosit controller	C7FG-__G, C9FG-__G, C9FG-8GP	1887600
2	101816	adapter	T7FG-__G, T9FG-__G	CM057701
3	110996	knob		CM058001
4	100009	piezoelectric igniter		1936100

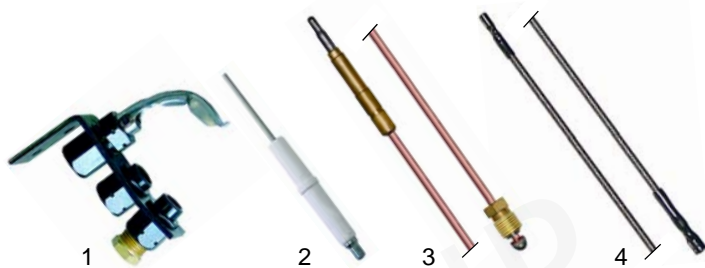

Item	Order	Description	Model	OEM
1	100859	pilot burner		1887700
2	100701	electrode	C9F-__, C9FP-__, T9F-__, T9FP-__	1888300
3	102042	thermocouple		1916000
4	100019	ignition cable		1936400



Item	Order	Description	Model	OEM
1	100073	pilot burner	704, 704S, 706, 706S, 706AS, TPF-706/706S	578800 411111
2	100703	electrode		636700
3	102044	thermocouple, 1200mm	704, 704S, 706, 706S, 706AS, TPF-706/706S	263800
3	102225	thermocouple, 220mm		933300
4	102011	extension, 400mm	CF-__GS/GT	933400



Item	Order	Description	Model	OEM
1	100109	pilot burner	C7FG-__G, C9FG-__G, C9FG-8GP	CM040800
2	100701	electrode	T7FG-__G, T9FG-__G	1888300
3	102042	thermocouple, 850mm		CM029100
4	100019	ignition cable, 900mm		1936400

Ovens (electric)

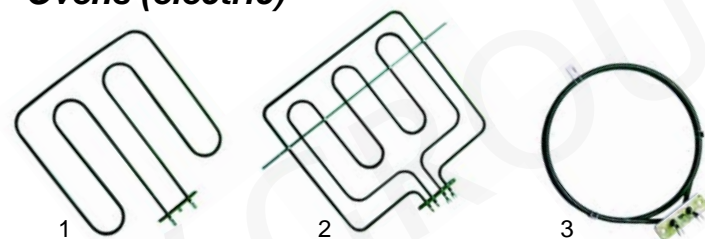

Item	Order	Description	Model	OEM
1	415968	1200W/230V		1037302400
2	415967	2600W/2 phases 230V	FOE-60M	1037302300
3	415966	2500W/230V	CFE-60, CFGE-61, FOE-60M	1037300200 1037300400



Item	Order	Description	Model	OEM
1	102059	thermocouple		1665000
2	100703	electrode	C70-__GFG, T70-__GFG, CFG-__	636700
3	100003	piezoelectric igniter		986000

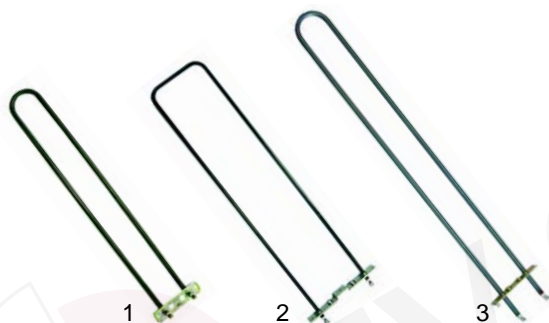

Item	Order	Description	Model	OEM
1	415972	1500W/230V	C70-__EFE/EFEQ	1890600
2	415088	1000W/230V	CF-4E, C9F-__E, C9FE-__GS	213443
3	416808	1000W/230V	C7FE-8E/EC, C7FE-G, C9FE-8E/EC, C9FE-G	CM018102

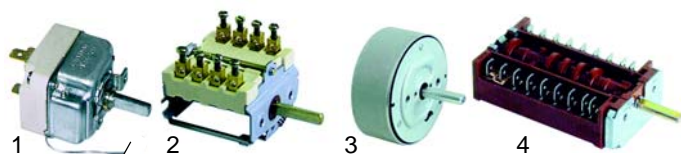

Item	Order	Description	Model	OEM
1	375002	thermostat, 50-300°C	CFGE-, CFE-__, CFVE-, FOE-60M	1037102300
2	300080	switch	CFGE-, CFE-, CFVE-	1037033200 710300
3	350036	time clock 60 min	CFGE-, CFE-, CFVE-, FOE-60M	1031006400
4	345708	oven changer switch	FOE-60M	1037103800



Item	Order	Description	Model	OEM
1	110405	knob	CFGE-CFE-, CFVE-, FOE-60M	1036700500 1036702200
2	110408	knob		
3	110421	knob, 60 min	CFGE-CFE-, CFVE-	1031020000
4	110422	knob, 300°C		1031019900

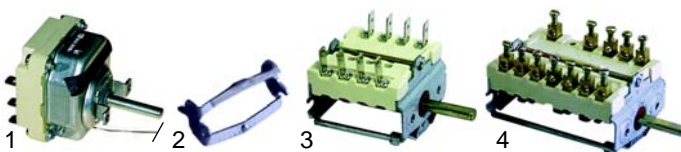

Item	Order	Description	Model	OEM
1	375192	thermostat, 50-300°C	C70-__EFE, C70-__EFEQ, C70-__FE, C9F-__E, C9FE- __GS,	1309100 1309115 921200
2	550060	retainer		
3	300002	switch	C__FE-8E/EC, C__FE-__G	710300
4	300081	changer switch		1309000



Item	Order	Description	Model	OEM
1	n. l. a.	thermostat, 300°C		425900
2	375192	thermostat, 300°C	CFE-__E	1309115
3	300002	switch		710300

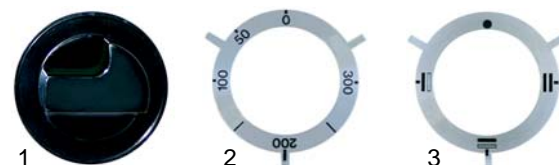

Item	Order	Description	Model	OEM
1	110360	knob	C70-EFE, C70-__FE,	1840700 1840400
2	110614	symbol, 300°C	C70-__EFEQ, C70-__GFE	1840513
3	110616	symbol/oven		

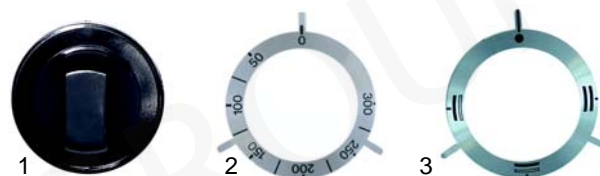

Item	Order	Description	Model	OEM
1	110386	knob		1508100
2	110631	symbol, 300°C	C9F-__E, C9FE-GS	1323300 1323500 1323513
3	110997	symbol/oven		

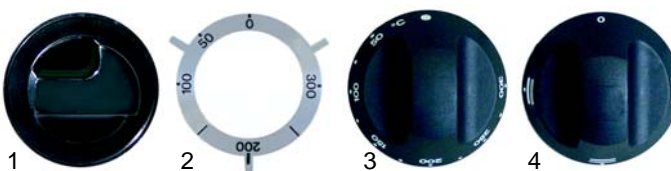

Item	Order	Description	Model	OEM
1	110360	knob	CF-__E	18407000 18404000
2	110614	symbol		
3	110998	knob/thermostat	C__FE-8E/EC, C__FE-__G (Predagonista)	CM059800 CM059700
4	110999	knob/oven		

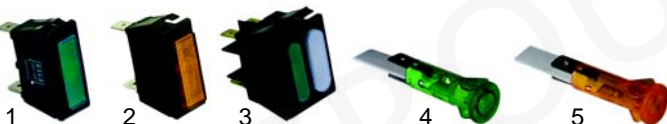

Item	Order	Description	Model	OEM
1	359160	signal lamp/green	CF-__FE	1230300
2	359159	signal lamp/yellow		912800
3	359164	signal lamp/double	C9F-__E, C9FE-__GS	1314400
4	359139	signal lamp/green	CFGE-, CFE-__, CFVE-, EOE-60M, C__FE-__E/EC, C__FE-__G	1037300800 1037300810 1037300900 1037300910
5	359140	signal lamp/yellow		

M

Suitable for Mareno



Item	Order	Description	Model	OEM
1	359142	signal lamp/green	C70-__EFE, C70-__EFEQ, C70-__GFE	21016199
2	359143	signal lamp/yellow		21016299
3	359142	signal lamp/green	C9F-__E, C9FE-__GS	1819800
4	359143	signal lamp/yellow		1819900

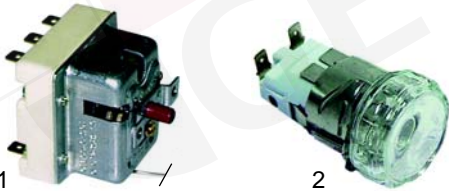

Item	Order	Description	Model	OEM
1	375187	safety thermostat, 360°C	universal	1878500
2	359718	bulb + housing	CFE-__, CFVE-__, CFGE-__	1037300100

Ovens (mechanical)

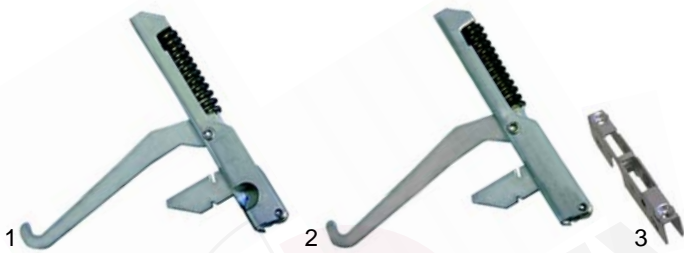

Item	Order	Description	Model	OEM
1	700014	hinge/right		1031105500
2	700013	hinge/left	CFE-60, CFGE-60	1031102000
3	700003	body section		1031106000



Item	Order	Description	Model	OEM
1	700015	hinge/right		1031105800
2	700016	hinge/left	FOE-60	1031105900
3	700003	body section		1031106000

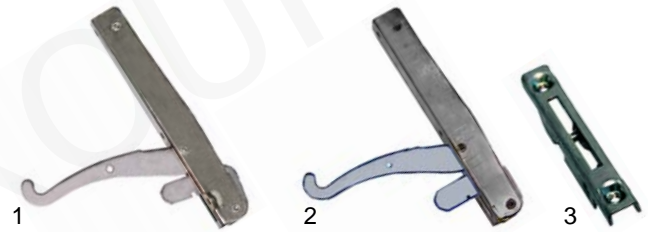

Item	Order	Description	Model	OEM
1	700004	hinge/right	CE70-__EFE/EFEQ, CE70-__FE/GFE, C9F-__G/GS/E, T9F-__G,	1304600
2	700005	hinge/left		1304700
3	700001	body section	T9FP-__, C9FP-__	1304500



Item	Order	Description	Model	OEM
1	700164	hinge	C__FE-__E/EC/G,	CM041300
2	700001	body section	C__FG-__G, T__FG-__G	1304500

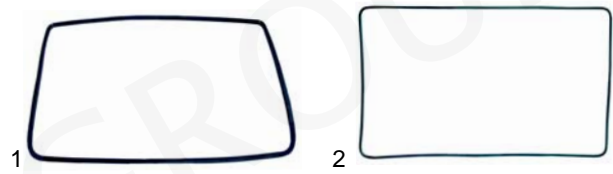

Item	Order	Description	Model	OEM
1	900404	gasket	CFG-__, CFE-,	1036608000
2	900405	gasket	CFVE-	1036101400

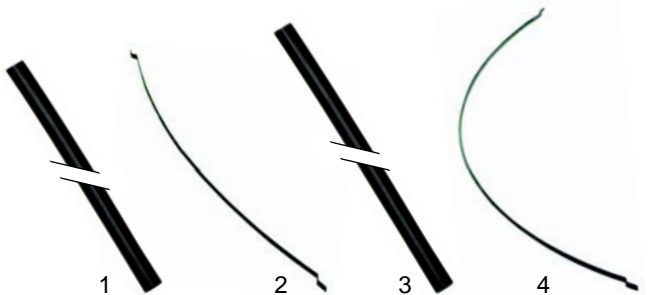

Item	Order	Description	Model	OEM
1	900104	gasket/side, 355 mm		1662814 1662800
2	514003	spring/side, 370 mm	C70-__EFE/EFEQ, C70-__FE/GFE, C70-__GFG,	1662614 1662600
3	900102	gasket/upper, 650 mm	T70-__GFG	1706300
4	514001	spring/upper, 655 mm		1706200

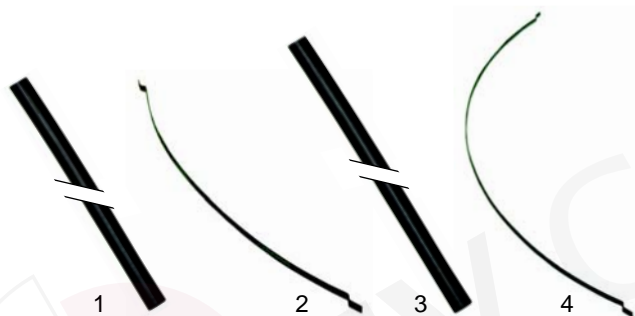

Item	Order	Description	Model	OEM
1	900105	gasket/side, 310mm		1336200
2	514004	spring/side, 325mm	C9F-__E/GS, C9FE-__GS,	1336000
3	900103	gasket/upper, 575mm	T9F-__G/GS	1336100
4	514002	spring/upper, 595mm		1335900

Fry tops (gas)



Item	Order	Description	Model	OEM
1	104240	burner	FTG-__	1031501000
2	105497	burner	FT7-__G/GR/GRL	1729700
3	104154	burner	FT__G__-L70/R70/RL70, FT__G__-LC70/RC70	1685400
4	104161	burner	F9V-__G/GR/GRL, F9SB- __G/GR/GRL	1351000



Item	Order	Description	Model	OEM
1	104153	burner	FT__G__-L90/R90/RL90, FT-G__-LC90/RL90	1475100
2	105490	burner	FT7__GL/GR/GLC/GM, FT7__GMC/GLLT/GMMT (Predagonista)	CM081302
3	105491	burner	FT9-__GMC/GLLT/GMMT	CM033503

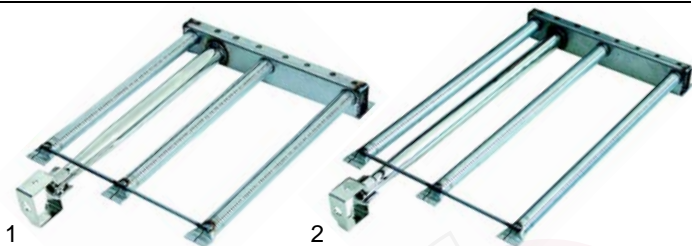

Item	Order	Description	Model	OEM
1	105492	burner	FT7-60GL/GR/GLC/GM, FT7-60GMC/GL/LTGMMT	CM081402
2	105493	burner	FT9-60GL/GR/GLC/GM, FT9-60GMC/GL/LTGMMT	CM079801



Item	Order	Description	Model	OEM
1	102034	thermocouple, 450mm		1033027500 1206400
2	101693	gas tap PEL21		1031500200
3	110406	knob	FTG-__B (old), BIG-40/60	1036700300
4	110450	knob		1036702300
5	110361	knob		1036703300
6	110601	symbol		1039110800



Item	Order	Description	Model	OEM
1	102247	thermocouple, 600mm	FTG-__B/BR/BLC (new)	1955500
2	101907	gas thermostat PEL25, 280°C	FTG-__B/BR (new)	1031503900 1031501700
2	101906	gas thermostat PEL25, 250°C	FTG-__BLC	1031504000
3	110406	knob		1036700300
4	110450	knob	FTG-B/BR/BLC	1036702300
5	110361	knob		1036703300
6	110948	symbol		1039121600



Item	Order	Description	Model	OEM
1	102040	thermocouple, 500mm		641900
2	101397	gas tap	FT7-G, FT7-GR,	1700500
3	110363	knob	FT7-GRL	1840800
4	110601	symbol		1842000



Item	Order	Description	Model	OEM
1	102041	thermocouple, 600mm		90520
2	101089	gas tap	F9V-__G/GR/GRL, F9SB-__G/GR/GRL	1337200
3	110388	knob		1022200
4	110620	symbol		1022300

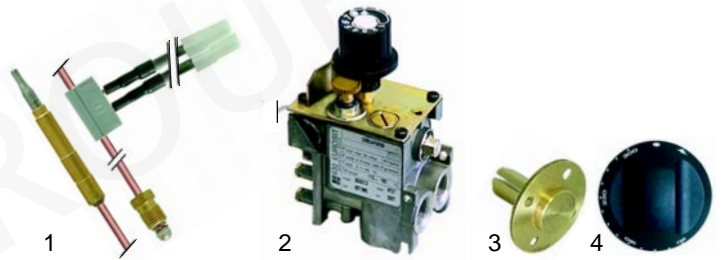

Item	Order	Description	Model	OEM
1	102247	thermocouple, 600mm		1950100
2	101125	Eurosit controller	FT__-GLC, FT__-GMC,	1887600
3	101816	adapter	FT__-LT/MT/RT (Predagonista)	CM057701
4	110460	knob		CM062401

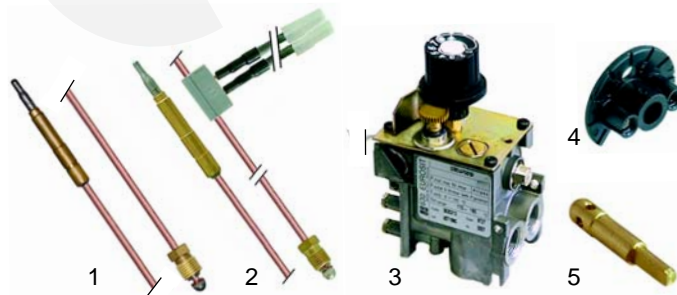

Item	Order	Description	Model	OEM
1	102042	thermocouple, 850mm	FT__-L__/R__/RL__	1916000
2	102247	thermocouple, 600mm	FT__-LC__/RC__	1955500
3	101125	Eurosit controller		1887600
4	101392	adapter	FT__-L__/R__/RL__	1868600
5	101390	spindle	FT__-LC__/RC__	1905525

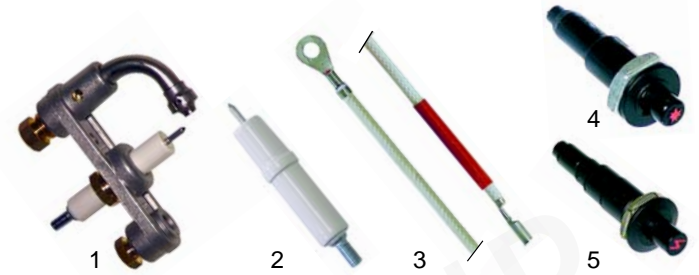

Item	Order	Description	Model	OEM
1	100073	pilot burner		1031027800 509900
2	100703	electrode	FTG-	1031025700 636700
3	100186	ignition cable		1047024400 1936300
4	100013	piezoelectric igniter, 22mm	FTG (I-series)	1031500600
5	100009	piezoelectric igniter, 18mm	FFG (II-series)	1936100

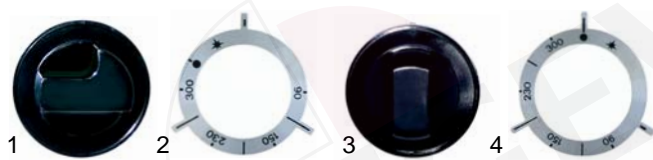

Item	Order	Description	Model	OEM
1	110360	knob	FT__-L70/R70, FT__- RL70/LC70, FT__- RC70	1840700
2	110603	symbol		1930400
3	110386	knob	FT__-L90/R90/RL90,	1508100
4	110622	symbol	FT__-LC90/RC90	1923300

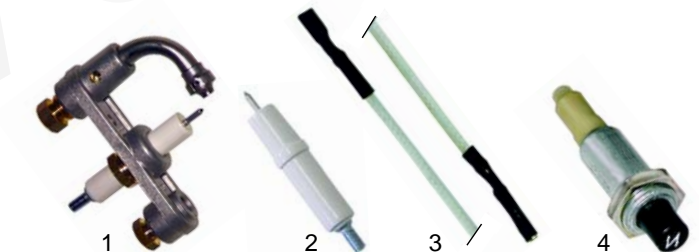

Item	Order	Description	Model	OEM
1	100073	pilot burner		509900
2	100703	electrode	FT7__-G/GR/GRL	636700
3	100199	ignition cable, 400mm		1088300
4	100003	piezoelectric igniter		986000

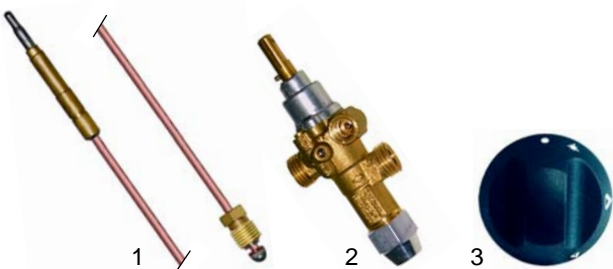

Item	Order	Description	Model	OEM
1	102042	thermocouple, 850mm		CM029100
2	101397	gas tap	FT__-GL/GR/GM (Predagonista)	1888900 1916900
3	110894	knob		CM061700

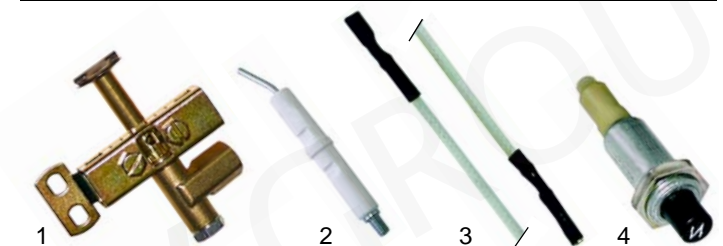

Item	Order	Description	Model	OEM
1	100046	pilot burner		1314500
2	100706	electrode	F9V-__G/GR/GRL, F9SB-__G/GR/GRL	224211
3	100199	ignition cable, 500mm		1088900
4	100003	piezoelectric igniter		986000

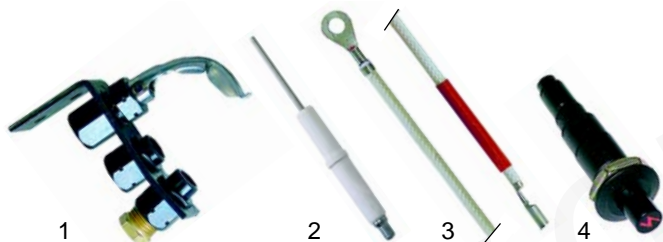

Item	Order	Description	Model	OEM
1	100859	pilot burner		1887700
2	100701	electrode	FT_-G_-L/R/RL/RC/LC70, FT_-G_-L/R/RL/RC/LC90, FT_-GR/GL/GLC/GM,	1949900 1888300
3	100186	ignition cable	FT_-GLT/GMT	1936300
4	100009	piezoelectric igniter		1936100

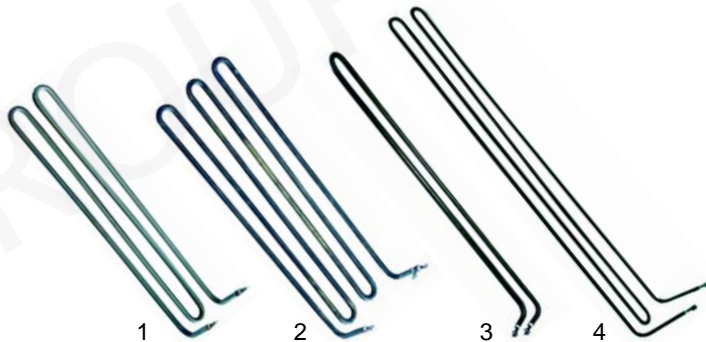

Item	Order	Description	Model	OEM
1	416175	1500W/230V	FT7-4EL/ER/EL, FT7-8EL/ELC/EM/EMC (700 series-Predagonista)	CM164800
2	416180	2200W/230V	FT-6EL/ELC/EM/EMC (700 series-Predagonista)	CM165100
3	415085	1400W/230V	FTC-__ (1 series bisNr. 191279)	167622
4	415086	2000W/230V	FTC-__, F9V-__ (900 series 1+2 series)	1029200

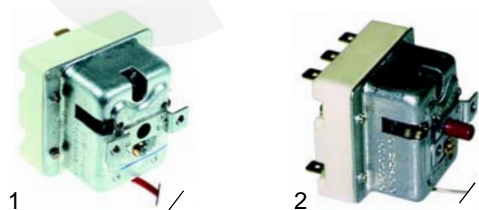

Item	Order	Description	Model	OEM
1	375357	safety thermostat	FTG_C	1942900
2	375187	safety thermostat	FT_G_-LC/RC, FT_-GLC/GMC, FT_-GMT/GLT/GRT	1878500

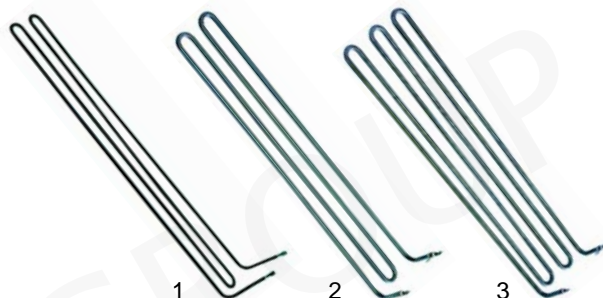

Item	Order	Description	Model	OEM
1	415958	1900W/230V	F9V-__ (900 III-series)	1941900
2	416694	2200W/230V	FT9-4EL/ELC/ER, FT9-8EL/ELC/EM/EMC (900 series-Predagonista)	CM164900
3	416695	3300W/230V	FT9-6EL/ELC/EM/EMC (900 series-Predagonista)	CM165200

Fry tops (electric)

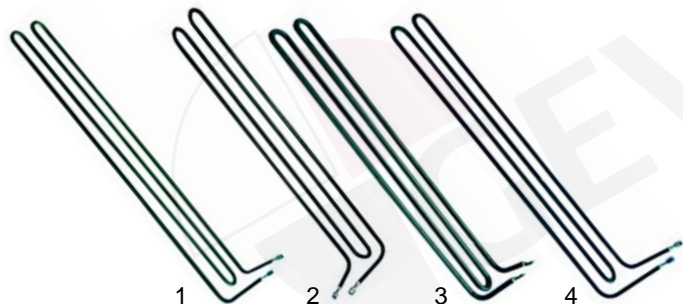

Item	Order	Description	Model	OEM
1	415076	1300W/230V	FTE-__, BIE-__ (600 series)	1037300700 1037300713
2	415087	1300W/230V	FTE-702/703	892800
3	415975	1800W/230V	FT7-__E/ER/ERL (700 II-series)	1730000
4	415982	1300W/230V	FT7-__E/ER/ERL/EC/ECRL (700 III-series)	1941800



Item	Order	Description	Model	OEM
1	375412	thermostat	FTE-__ (600 II-series),	1732000 1037035200
2	550060	retainer	FT7-__ (700 II-series)	1037033300
3	300080	switch		1037033200

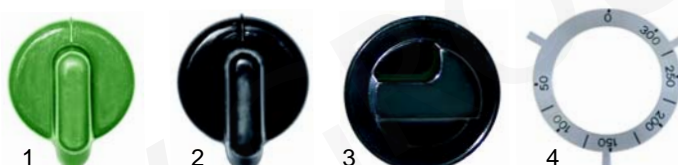

Item	Order	Description	Model	OEM
1	110405	knob	FTE-__ (600 III-series)	1036700500 1036702200
2	110408	knob		1840700
3	110360	knob	FT7-__ (700 II-series)	1039107500
4	110615	symbol		

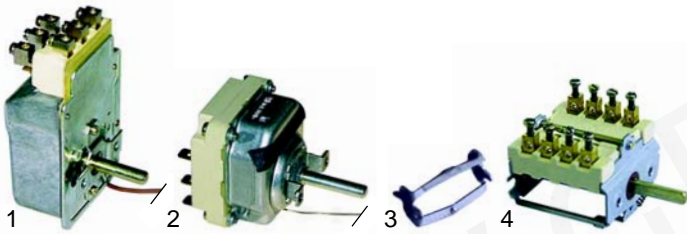

Item	Order	Description	Model	OEM
1	no longer available	thermostat	FTE-___, BTE (600 III-series), FTE- (700 I-series), FT7-___ (700 III-series), FTC-___ (900 I-series), F9V-___ (900 series 2+3 series), FT7-___ (700 series-Predagonista), FT9-___ (900 series-Predagonista)	425900
2	375192	thermostat		1309100 1309115
3	550060	retainer		921200
4	300080	switch		710300



Item	Order	Description	Model	OEM
1	359160	signal lamp/green	FTE- (700 series I-series), FTC- (900 series I-series), F9V- (900 series II-series)	1230300 912800
2	359159	signal lamp/yellow		
3	359139	signal lamp/green	FTE- (600 series II+IIIseries), BTE- (600 series), FT7- (700 III-series), F9V- (900 III-series), FT7- (700 Predagonista), FT9 (900 Predagonista)	1037300800 1037300810
4	359140	signal lamp/yellow		1037300900 1037300910

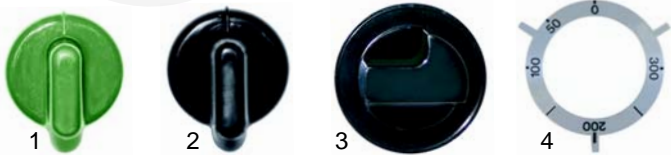

Item	Order	Description	Model	OEM
1	110405	knob		1036700500
2	110408	knob	FTE-___, BTE-___ (600 III-series)	1036702200
3	110362	knob		1036700900
4	110614	symbol		1840400

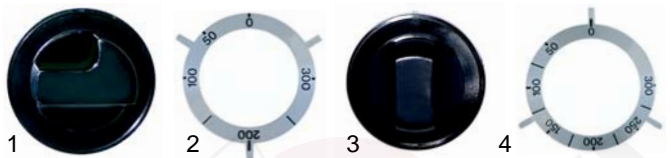

Item	Order	Description	Model	OEM
1	110360	knob	FTE- (700 I-series), FT7-___ (700 III-series), FTC-___ (900 I-series)	1840700 1840400
2	110614	symbol		
3	110386	knob	F9V-___ (900 series 2+3 series)	1508100
4	110631	symbol		1323300

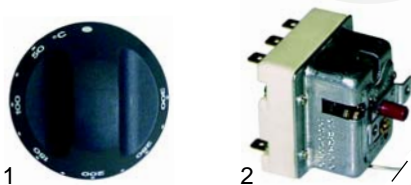

Item	Order	Description	Model	OEM
1	110998	knob	FT7 (700 Predagonista), FT9 (900 Predagonista)	CM059800
2	375187	safety thermostat	universal	1878500



Item	Order	Description	Model	OEM
1	359142	signal lamp/green	FT7 (700 II-series)	21016199
2	359143	signal lamp/yellow		21016299

Fry tops (ceramic)

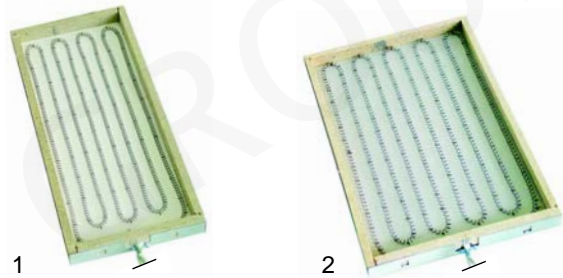

Item	Order	Description	Model	OEM
1	416696	1500W/230V	FTVE-60	1037311013
2	416697	2500W/230V	FTVE-40/80	1037311213



Item	Order	Description	Model	OEM
1	380015	energy regulator		1037110113
2	110405	knob		1036700506
3	110408	knob		1036702200
4	110362	knob	FTVE-___	1036700900
5	110608	symbol		1039115600
6	359139	signal lamp		1037300810

Lava rock grills (gas)



Item	Order	Description	Model	OEM
1	104156	burner	PLG-__, GB70-__, GB9-__	1031501400 1828100 1828112
2	105494	burner	GL7-__	CM203100
3	105495	burner	GL9-__	CM201900

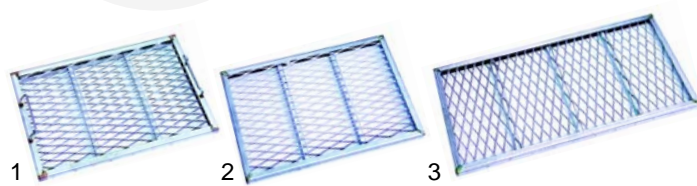

Item	Order	Description	Model	OEM
1	211029	lava rock grid	PLG-__, GB70-__, GB9-__	1041301400 1829522 1829500
2	211030	lava rock grid	GL7-__	CM207900
3	211031	lava rock grid	GL9-__	CM209400

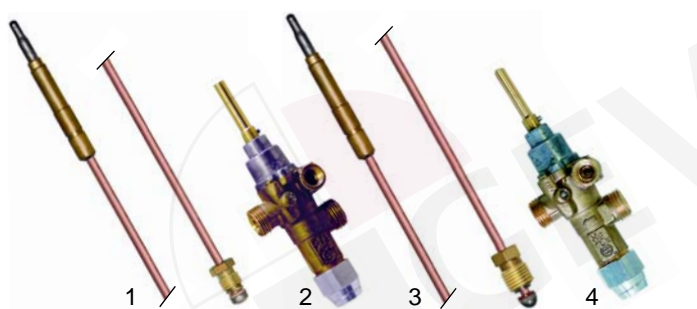

Item	Order	Description	Model	OEM
1	102034	thermocouple, 600mm	PLG-__ (I-series)	1033027500
2	101693	gas tap		1031500200
3	102042	thermocouple, 850mm	PLG-__ (II-series)	1916000
4	101913	gas tap		1031501300

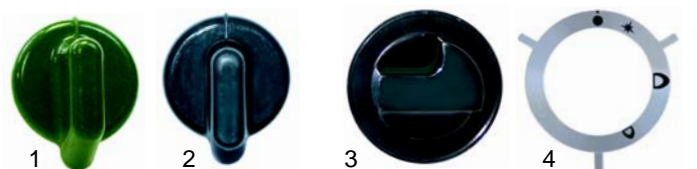

Item	Order	Description	Model	OEM
1	110406	knob		1036700300
2	110450	knob	PLG	1036702300
3	110361	knob		1036703300
4	110601	symbol		1039110800



Item	Order	Description	Model	OEM
1	102035	thermocouple, 850mm	GB70- (I-series)	1206500
2	101095	gas tap		1700500
3	102042	thermocouple, 850mm	GB70- (II-series), GB9-	1916000
4	101397	gas tap		1916900

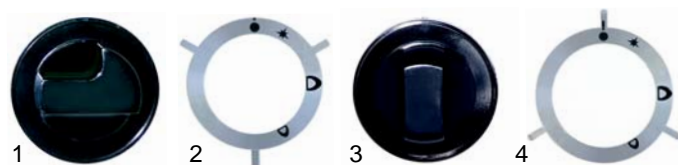

Item	Order	Description	Model	OEM
1	110363	knob	GB70-	1840800
2	110601	symbol		1842000
3	110387	knob	GB9-	1893400
4	110620	symbol		1322300



Item	Order	Description	Model	OEM
1	102042	thermocouple		CM029100
2	101397	gas tap	GL7-, GL9-	CM226800 1888700
3	110894	knob		CM061700



Item	Order	Description	Model	OEM
1	100073	pilot burner		1031027800
2	100703	electrode	PLG (I-series)	1031025700
3	100186	ignition cable		1047024400
4	100013	piezoelectric igniter		1031500600



Item	Order	Description	Model	OEM
1	100859	pilot burner	PLG- (II-series),	1887700
2	100701	electrode	GB70- (II-series),	1888300
3	100186	ignition cable	GB9-, GL7-, GL9-	1936300
4	100009	piezoelectric igniter		1936100

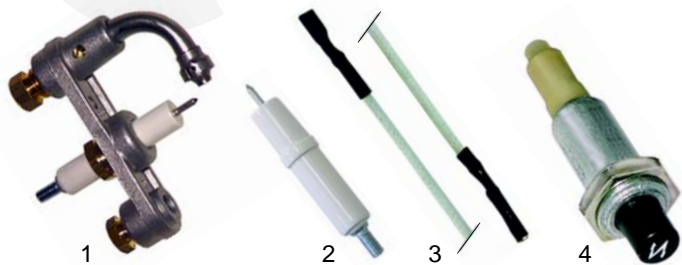

Item	Order	Description	Model	OEM
1	100073	pilot burner		509900
2	100703	electrode	GB70 (I_series)	636700
3	100199	ignition cable		1152700
4	100003	piezoelectric igniter		986000

Chargrills (electric)



Item	Order	Description	Model	OEM
1	415095	1500W/230 V	CWE40/41, CWE60/61	1037300000
2	415965	1800W/230 V	CWE42/62	1037311315
3	210152	shelf	CWE-	1032100000



Item	Order	Description	Model	OEM
1	375412	thermostat		1037035200
2	550060	retainer	CWE40, CWE60	1037033300
3	300080	switch		1037033200



Item	Order	Description	Model	OEM
1	375192	thermostat		1309115
2	550060	retainer	CWE42, CWE62	921200
3	300080	switch		710300

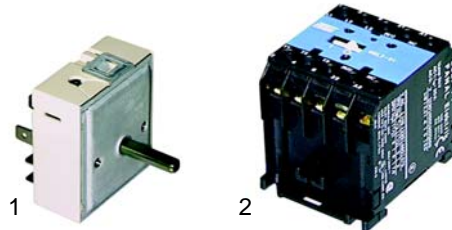

Item	Order	Description	Model	OEM
1	380015	energy regulator	CWE41, CWE61	1037035310
2	380213	contactor		1037104800 CM187300



Item	Order	Description	Model	OEM
1	110463	knob		1036700700
2	111500	knob	CWE-	1036702600
3	110360	knob		1840700
4	110614	symbol		1840400



Item	Order	Description	Model	OEM
1	375187	safety thermostat		1878500
2	359139	signal lamp/green	CWE-	1037300810
3	359140	signal lamp/yellow		1037300910

Bratt pans/boiling kettles (gas)



Item	Order	Description	Model	OEM
1	104150	burner	BRG40/40G	1031002300
2	102039	thermocouple	BRG40/40G	1031500400
3	101457	gas tap	(I-series)	1031027900

Bratt pans/boiling kettles (electric)

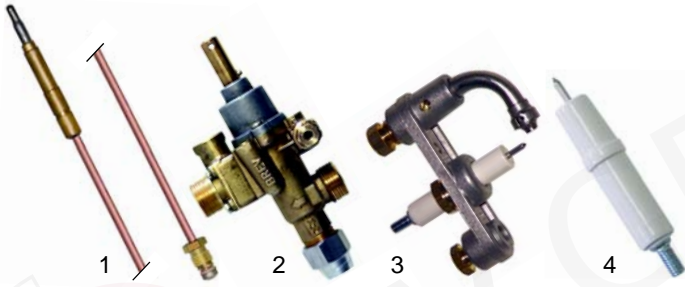

Item	Order	Description	Model	OEM
1	102034	thermocouple	BRG40/40G	1206400
2	101909	gas tap	(II-series)	1031503700
3	100073	pilot burner	BRG40/40G	1031027800
4	100703	electrode	(I+II-series)	509900 1031025700 636700



Item	Order	Description	Model	OEM
1	100186	ignition cable	BRG40/40G	1047024400
2	100013	piezoelectric igniter, 22mm	(I-series)	1031500600

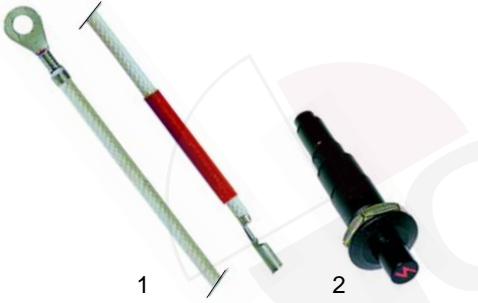

Item	Order	Description	Model	OEM
1	100186	ignition cable	BRG40/40G	1936300
2	100009	piezoelectric igniter, 18mm	(II-series)	1936100

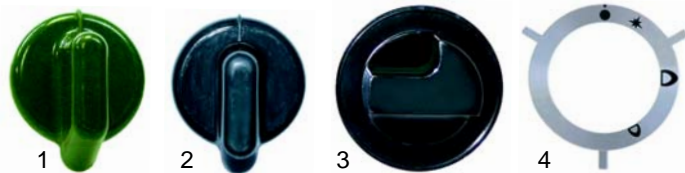

Item	Order	Description	Model	OEM
1	110406	knob		1036700300
2	110450	knob	BRG40/40G	1036702300
3	110361	knob	(I+II-series)	1036703300
4	110601	symbol		1039111800

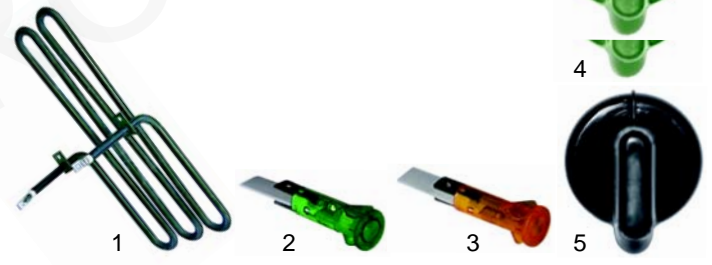

Item	Order	Description	Model	OEM
1	415077	1300W/230V		1037301700 1037301713
2	359139	signal lamp/green		1037300800 1037300810
3	359140	signal lamp/yellow	BRE40/40G	1037300900 1037300910
4	110405	knob	(I+II-series)	1036700500
5	110408	knob		1036702200



Item	Order	Description	Model	OEM
1	375412	thermostat		1037035200
2	550060	retainer	BRE40/40G	1037003300
3	300080	switch	(I-series)	1037033200



Item	Order	Description	Model	OEM
1	375192	thermostat		1309100
2	550060	retainer	BRE40/40G	921200
3	300080	switch	(II-series ab 1997)	710300

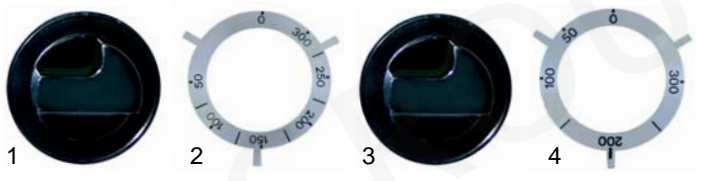

Item	Order	Description	Model	OEM
1	110362	knob	BRE40/40G	1036700900
2	110615	symbol	(I-series)	1039107500
3	110362	knob	BRE40/40G	1036700900
4	110614	symbol	(II-series)	1840400

M Multi bratt pans (electric)

Suitable for Mareno

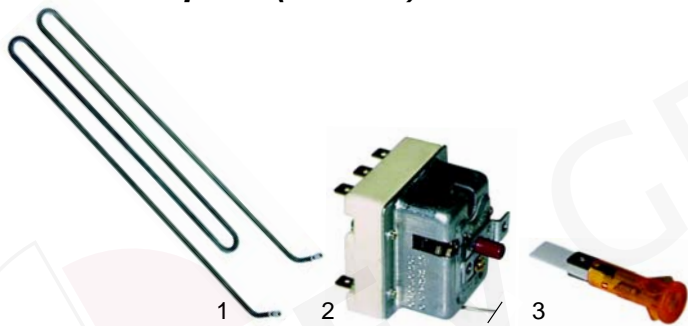

Item	Order	Description	Model	OEM
1	416698	1300W/230 V	VB7-	1037317700
2	375187	safety thermostat	4E, VB7-6E, VB9-6E	1878500
3	359140	signal lamp/yellow		1037300910

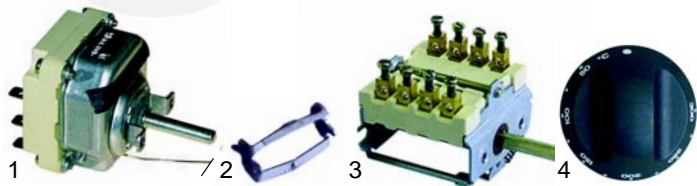

Item	Order	Description	Model	OEM
1	375192	thermostat		1309115
2	550060	retainer	VB7-	921200
3	300080	switch	4E, VB7-6E, VB9-6E	710300
4	110998	knob		CM059806

Pasta cookers (gas)



Item	Order	Description	Model	OEM
1	105496	burner	CPG60	1031502600
2	105497	burner	CP70-7G	1729700
3	104243	burner	CP70-4G	1833100



Item	Order	Description	Model	OEM
1	104244	burner	CP9-___, CP9SB-___	2708514 2708500
2	105498	burner	PC7-4G	CM088200
3	105499	burner	PC7-6G, PC9-6G, PC9S-6G	CM088100



Item	Order	Description	Model	OEM
1	102034	thermocouple		1033027500
2	101457	gas tap	CPG-60	1031027900
3	100013	piezoelectric igniter		1031500600
4	100186	ignition cable		1047024400



Item	Order	Description	Model	OEM
1	110406	knob		1036700300
2	110450	knob	CPG-60	1036702300
3	110361	knob		1036703300
4	110601	symbol		1039110800



Item	Order	Description	Model	OEM
1	100837	pilot burner upper part		1031501900
2	100883	pilot burner lower part		1031501800
3	100706	electrode	CPG-60	1031502500
4	100893	pilot burner holder		1031502200
5	100894	supporting arm		1031502300



Item	Order	Description	Model	OEM
1	102042	thermocouple		2716500
2	101089	gas tap	CP70-7G	1337200
3	110364	knob		1840900
4	110601	symbol		1842000



Item	Order	Description	Model	OEM
1	102041	thermocouple		90520
2	101089	gas tap	CP9-2G/4G	1337200
3	110388	knob	(I-series)	1322200
4	110620	symbol		1322300



Item	Order	Description	Model	OEM
1	100859	pilot burner		1887700
2	100701	electrode	CP70-4G, CP9-2G/4G, CP9SB-	1888300
3	100186	ignition cable	2G/4G (II-series)	1936300
4	100009	piezoelectric igniter		1936100

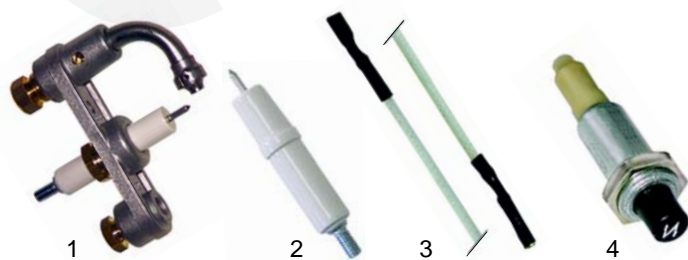

Item	Order	Description	Model	OEM
1	100073	pilot burner		509900
2	100703	electrode	CP70-7G, CP9-2G/4G	636700
3	100199	ignition cable, 500mm		1152500
4	100003	piezoelectric igniter		986000



Item	Order	Description	Model	OEM
1	102042	thermocouple	PC7-4G/6G,	CM029100
2	101086	gas tap	PC9-6G,	1888600
3	110993	knob	PC9S-6G	CM061600



Item	Order	Description	Model	OEM
1	102042	thermocouple		1916000
2	101086	gas tap	CP70-4G	1888600
3	110364	knob		1840900
4	110601	symbol		1842000

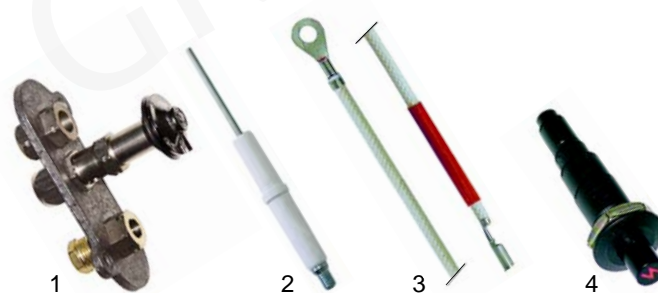

Item	Order	Description	Model	OEM
1	100109	pilot burner		CM040800
2	100701	electrode	PC7-4G	1888300
3	100186	ignition cable		1936300
4	100009	piezoelectric igniter		1936100



Item	Order	Description	Model	OEM
1	102042	thermocouple		1916000
2	101086	gas tap	CP9-2G/4G, CP9SB-2G/4G (II-series)	1888600
3	110388	knob		1322200
4	110620	symbol		1322300



Item	Order	Description	Model	OEM
1	100050	pilot burner		CM029000
2	100701	electrode	PC7-6G, PC9-6G, PC9S-6G	1949900
3	100186	ignition cable		1936300
4	100009	piezoelectric igniter		1936100

M Pasta cookers (electric)

Suitable for Mareno

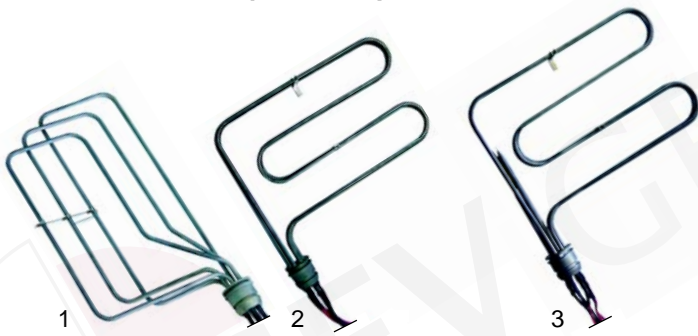

Item	Order	Description	Model	OEM
1	416699	4500W/3 phases 230V	CPE-60 (I-series)	1037301200
2	415094	9000W/3 phases 230V	CPE-60 (II-series)	1037305800
3	415971	9000W/3 phases 230V	CPE-60 (III-series), PC7-6E, PC9-6E	1037305810 1870100 1677000

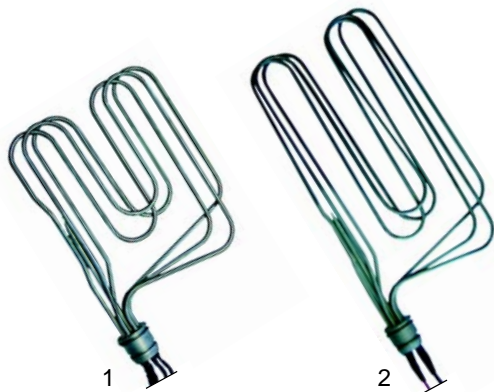

Item	Order	Description	Model	OEM
1	415977	5670W/3 phases 230V	CP70-4E, PC7-4E	1870000
2	415991	8500W/3 phases 230V	CP9-2E/4E, CP9-2E/2, CP9-4E/2, PC9-4E/8E	1814213 1869900



Item	Order	Description	Model	OEM
1	514018	bush		1033703500 1814600
2	514021	O-ring	CPE-60, CP70-4E, PC70-4E/6E, CP9-2E/4E, CP9-2E/2, CP9-4E/2, PC9-4E/6E/8E	1036500300 1814700
3	514022	nut, 1/2"		1032300100 14044599
4	514016	teflon gasket		1036500400 1814500
5	514017	O-ring/heating		1036500200 1814400



Item	Order	Description	Model	OEM
1	514020	heating element bush	CPE-60 (heating thermostat pocket)	1815014 1815000 1036500100
2	514019	threaded rod, M8		1033202200 1033709000
3	540435	threaded rod, M10	CPE-60, CP70-4E, PC7-4E/6E, CPE-2E/4E, CPE-2E/2, CPE-4E/2, PC9-4E/6E/8E	1869600
4	540439	distance bush		1869500
5	540436	nut, M10		1033514900
6	540438	long nut, M10		1868700



Item	Order	Description	Model	OEM
1	300104	4-position switch		1037100500 790700
2	110463	knob	CPE-60 (II-series)	1036700700
3	110360	knob		1840700
4	110605	symbol		1039111200



Item	Order	Description	Model	OEM
1	300104	4-position switch		790700
2	110386	knob	CP9-2E, CP9-4E	1508100
3	110626	symbol		1322700



Item	Order	Description	Model	OEM
1	380015	energy regulator	CPE60E (III-series), CP70-4E, CP9-2E/4E, CP9S-2E/4E, PC7-4E/8E, PC9-4E/6E/8E, PC9S-4E/6E/8E	426710
2	380213	contactor		21453199 CM187300
3	375199	safety thermostat		1878900



Item	Order	Description	Model	OEM
1	110463	knob		1036700700
2	110360	knob	CPE-60E (IV-series), CP70-4E	1840700
3	110607	symbol		1986600

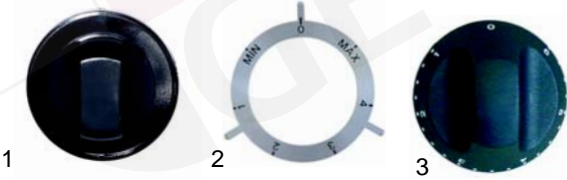

Item	Order	Description	Model	OEM
1	110386	knob	CP9-2E/4E, CP9S-2E/4E	1508100
2	110627	symbol		1966800
3	110995	knob	PC7-___, PC9-___	CM062500

Pasta cookers (mechanical)



Item	Order	Description	Model	OEM
1	514012	drain tap, 3/4"		1450500 1031103600
2	514013	lever joint	CPE-60	1031400400
3	514008	lever handle		1036700000
4	514015	lever handle		1036702000



Item	Order	Description	Model	OEM
1	514005	drain tap		1031024110
2	514007	lever joint		1044109600
3	514008	lever handle	CPG-60	1036700000
4	514015	lever handle		1036702000
5	514006	drain pipe		1033061900



Item	Order	Description	Model	OEM
1	514012	drain tap, 3/4"		1450500
2	514050	extension	CP9-2G/4G, CP9-2G/4E,	1515500
3	514051	handle	CP9SB-2E/4E,	32000599
4	514052	inlet tap	CP9SB-2G/4G	1475300
5	514053	handle		832400



Item	Order	Description	Model	OEM
1	514012	drain tap, 3/4"		1450500
2	514054	extension	CP70-4G, CP70-4E	1959600
3	514055	inlet tap		700714
4	514051	handle		32000599

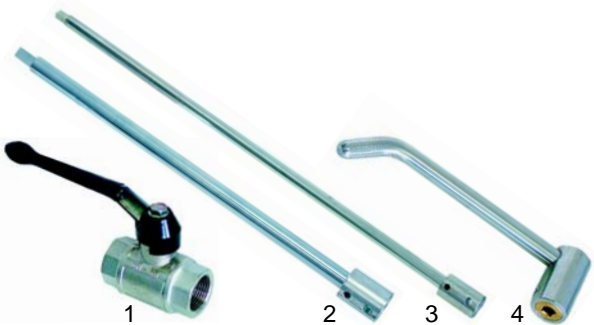

Item	Order	Description	Model	OEM
1	514056	drain tap	PC7-, PC9-	1950700
2	514057	extension	PC7-6E/G	CM197300
3	514058	extension	PC9-6E/G	CM202900
4	514059	lever	PC7-, PC9-	CM155200



Item	Order	Description	Model	OEM
1	514060	inlet tap	PC7-6G/6E, PC9-6G/6E	CM127800
2	514061	knob		CM143100



Item	Order	Description	Model	OEM
1	970196	basket	CPG-60, LPE-60	1031100000
2	970197	basket, 1/3	CP9-__, CP70-__	1510100
3	970347	basket, 1/3	PC7-__, PC9-__	MA9733700

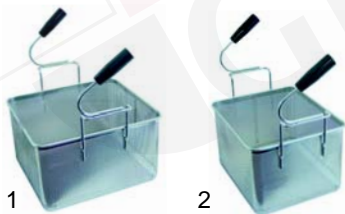

Item	Order	Description	Model	OEM
1	970348	basket, 2/3	CP9-__, CP70-__	MA9733800
2	970351	basket, 1/2	PC7-__, PC9-__	MA9733900

Bains-marie (gas)



Item	Order	Description	Model	OEM
1	104150	burner	BMG-40/60	1031002300
2	105513	burner	BM7-4G/7G	1845614
3	105514	burner	B9V-2G/4G, B9SB-2G/4G	1360700, 1360724



Item	Order	Description	Model	OEM
1	105515	burner	B7-4G, B9-4G	CM140600
2	105516	burner	B7-8G, B9-8G	CM140700



Item	Order	Description	Model	OEM
1	101088	Minisit controller		1031501100
2	111501	knob	BMG-40/60	1036700400
3	110407	knob		1036702400
4	110068	knob		1393500

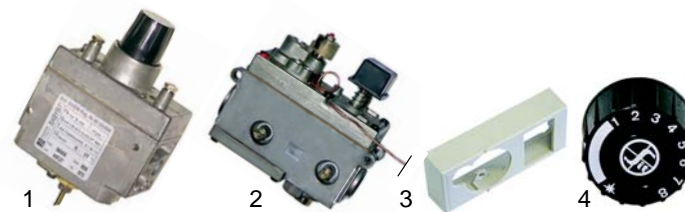

Item	Order	Description	Model	OEM
1	101104	Babysit controller	702-BMG, BC-2GS/4GS, BH-2GS/4GS, BM7-4G/7G, B9V-2G/4G, B9SB-2G/4G (II+III-series)	711500, 1047100, 1047112, 1876200, 1876300
2	101130	Minisit controller		1120813, 1393400
3	101137	cover	BM7-4G/7G (I-series)	1393600
4	110068	knob		1393500



Item	Order	Description	Model	OEM
1	101441	gas thermostat PEL25	B7-4G/8G, B9-4G/8G	CM140500
2	111502	knob		CM140200
3	102041	thermocouple, 600mm	BMG-40, 702BMG, BC-2GS/4GS, BH-2GS/4GS, BM7-4G/7G, B9V-2G, B9SB-2G	1033027600, 1031501500, 90520
3	102042	thermocouple, 850mm	BMG-60, BM7-4G/7G (II-series), B9V-2G, B9SB-2G (II-series), B7-4G/8G, B9-4G/8G	1031501600, 1916000, CM029100
3	102044	thermocouple, 1200mm	B9V-4G, B9SB-4G	263800



Item	Order	Description	Model	OEM
1	100073	pilot burner	BMG-40/60 (I+II-series)	1031027800
2	100703	electrode		1031025700
3	100019	ignition cable, 900mm		1047024400 1047024600
4	100013	piezoelectric igniter		1031500600



Item	Order	Description	Model	OEM
1	100073	pilot burner	BM7-4G/7G (I-series)	411111
2	100703	electrode		638700
3	100199	ignition cable, 600mm		1152700
4	100003	piezoelectric igniter		986000

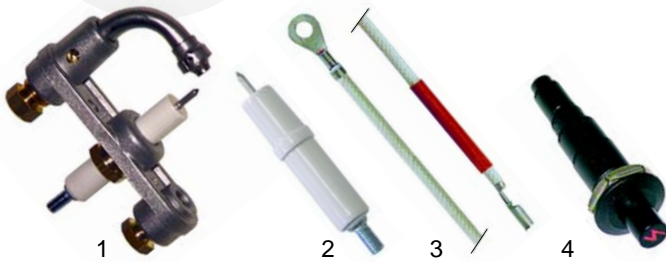

Item	Order	Description	Model	OEM
1	100073	pilot burner	BMG-40/60 (III-series)	509900
2	100703	electrode		636700
3	100186	ignition cable		1936300
4	100009	piezoelectric igniter		1936100



Item	Order	Description	Model	OEM
1	100046	pilot burner	B9V-2G/4G, B9SB-2G/4G (I-series)	431500
2	100706	electrode		224211
3	100199	ignition cable, 600mm		1088600
3	102155	ignition cable, 750mm		1152600
4	100003	piezoelectric igniter	986000	

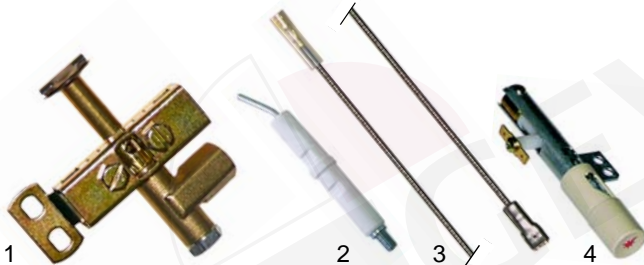

Item	Order	Description	Model	OEM
1	100046	pilot burner	BC-2GS/4GS, BA-2GS/4GS (I-series)	431500
2	100706	electrode		224211
3	100025	ignition cable, 600mm		671300 671400 671500 672400
4	100007	piezoelectric igniter		224311



Item	Order	Description	Model	OEM
1	100859	pilot burner	BM7-4G/7G (III-series), B9V-2G/4G, B9SB-2G/4G (II-series)	1887700
2	100701	electrode		1888300
3	100186	ignition cable		1936300
4	100009	piezoelectric igniter		1936100



Item	Order	Description	Model	OEM
1	100046	pilot burner	BE-2G/4G, BA-2G/4G (II-series), BM7-4G/7G (II-series)	1314500
2	100706	electrode		224211
3	100199	ignition cable, 600mm		1088600
4	100003	piezoelectric igniter		986000



Item	Order	Description	Model	OEM
1	100050	pilot burner	B7-4G/8G, B9-4G/8G	CM029000
2	100701	electrode		1949900
3	100186	ignition cable		1936300
4	100009	piezoelectric igniter		1936100

M

Bains-marie (electric)

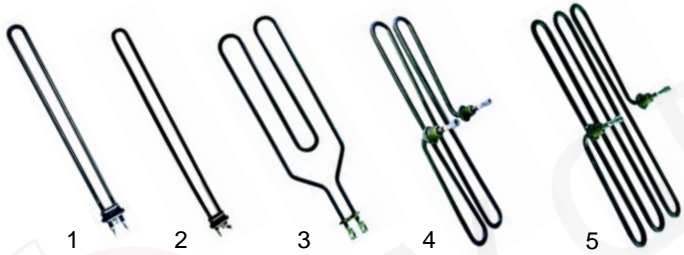

Item	Order	Description	Model	OEM
1	415082	2200W/240V	702 BME BC-2E/BA2E	704100 33610
2	415081	1800W/240V	BC-4E/BA43	627510
3	415164	900W/240V	702 BME Heating furnace	59741
4	415091	1000W/240V	BME 40M/60M/80M BME70-4E	1037039500 1037039513
5	415092	1300W/240V	BME60 BME60/2 BME70-6E	1037039613

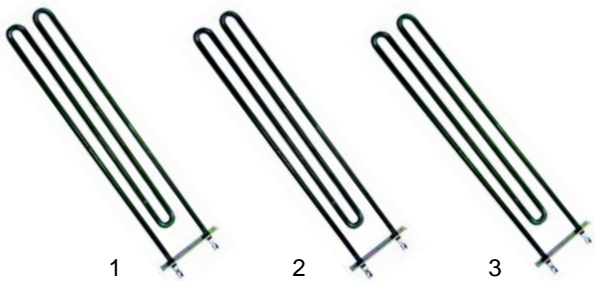

Item	Order	Description	Model	OEM
1	415992	1800W/240V	BM7-7E B9V-4E B9SB-4E B7-4E/8E B9-4E/8E	1368400 1634200
2	415083	2200W/240V	BM7-4E B9V-2E B9SB-2E	1360900 1368400 1369700 1634300
3	415979	1500W/240V	BM7-7E	1634100



Item	Order	Description	Model	OEM
1	375410	thermostat	BME-40/60, BSE-40M, BME-4E/7E, B7-4E/8E, B9-4E/8E	1037035015 1037035000 1230200
2	550060	retainer	BME-40/60, BSE-40M, 921200	1037033300 921200
3	300080	switch	BME-4E/7E (I+III series)	710300 1037033200
4	300021	switch, 0-1	BME-4E/7E (II-series), B7-4E/8E, B9-4E/8E	1230100



Item	Order	Description	Model	OEM
1	n. l. a.	thermostat		264000
2	375188	thermostat	BME-702/704, B9V-2E/4E, B9SB2E/4E	alternative 264000
3	550148	gland		710300
4	300080	switch		710300

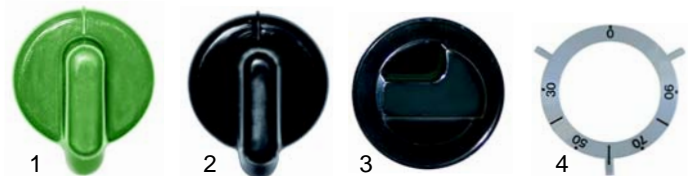

Item	Order	Description	Model	OEM
1	110405	knob		1036700500
2	110408	knob	BME-40/60, BSE-40	1036702200
3	110362	knob		1036700900
4	110610	symbol		1218500

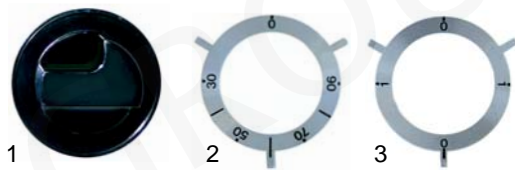

Item	Order	Description	Model	OEM.
1	110360	knob		1840700
2	110610	symbol	BM7-4E, BM7-7E	1218500
3	110604	symbol		1229000

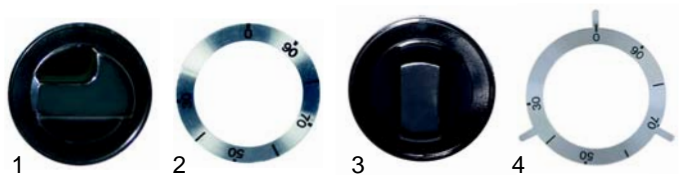

Item	Order	Description	Model	OEM
1	110360	knob		1840700
2	111531	symbol	BME-702/704	862500
3	110386	knob	B9V-2E/4E, B9SB-2E/4E	1508100
4	110628	symbol		1323200

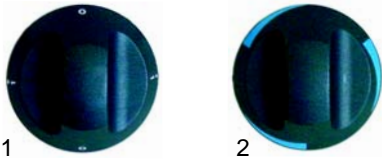

Item	Order	Description	Model	OEM
1	111503	knob	B7-4E/8E,	CM140000
2	111504	knob	B9-4E/8E	CM140100

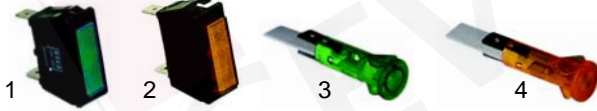

Item	Order	Description	Model	OEM
1	359160	signal lamp/green	BME-702/704,	1230300
2	359159	signal lamp/yellow	B9V-2E/4E (I-series), B9SB-2E/4E (I-series)	912800
3	359139	signal lamp/green	BME-40/60, BM7-4E/7E (II-series),	1037300800 1037300810
4	359140	signal lamp/yellow	B9V-2E/4E (II-series), B9SB-2E/4E (II-series), B7-4E/8E, B9-4E/8E	1037300900 1037300910

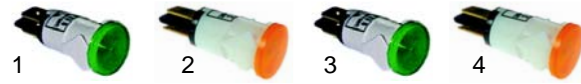

Item	Order	Description	Model	OEM
1	359142	signal lamp/green	BM7-4E/7E (I-series)	1819800
2	359143	signal lamp/yellow		1819900
3	359142	signal lamp/green	BM70-4E/6E	21016199
4	359143	signal lamp/yellow		21016299

Bains-marie (mechanical)



Item	Order	Description	Model	OEM
1	514005	drain tap		1031024100
2	514007	lever joint		1044109600
3	514008	lever handle	BMG-___,	1036700000
4	514015	lever handle	BME	1036702000
5	514006	drain pipe		1033061900

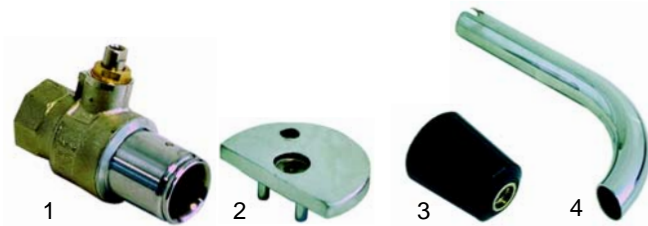

Item	Order	Description	Model	OEM
1	514031	drain tap		10404-10 40404-24
2	514032	lever joint	B9V-2G/4G, B9V-2E/4E,	10416-22
3	514033	lever handle	B9SB-2G/4G,	498500
4	514006	drain pipe	B9CB-2E/4E	866100 1033300300



Item	Order	Description	Model	OEM
1	514031	drain tap		1040424
2	514007	lever joint	BM7-4G/7G,	1044109600
3	514015	lever handle	BM7-4E/7E	1851700 103670200
4	514006	drain pipe		1033300300

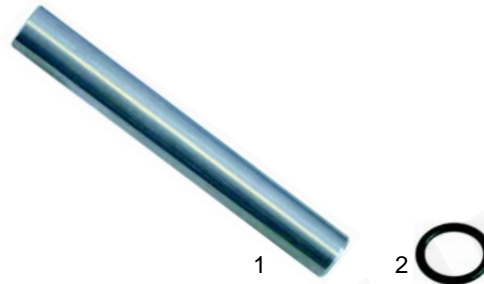

Item	Order	Description	Model	OEM
1	514221	drain plug	B7-4G/8G/4E/8E,	CM142100
2	514222	gasket	B9-4G/8G/4E/8E	CM142000

Chip scuttles



Item	Order	Description	Model	OEM
1	415091	1000W/240V	BSE-40M	1037039500 1037039513
2	415104	1000W/240V	CSP-6220 CSP-6220	1037039600

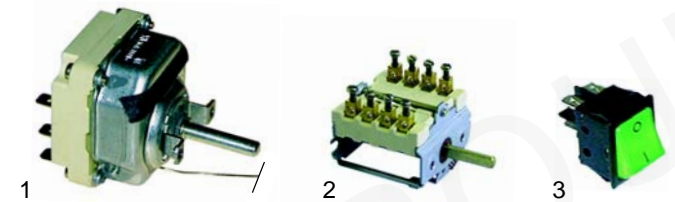

Item	Order	Description	Model	OEM
1	375410	thermostat	BSE-40M	1037035015
2	300080	switch	CSP	710300
3	301003	switch	CSP	4640500

Fryers (gas)



Item	Order	Description	Model	OEM
1	104242	burner/right	FQG-40/60	1032001300
2	104241	burner/left		1032001200
3	105517	burner	FR7-4G/7G, FR9-2G13/22, FR9-4G13/22	1450000
4	105518	burner	F7-4G15/8G15, F9-4G15/8G15, F9S-4G15/8G15, F9S-4G22/8G22	CM011401

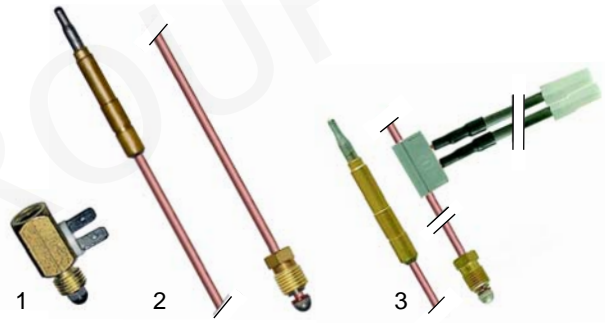

Item	Order	Description	Model	OEM
1	101265	thermocouple interrupter, M9x1		1533400 1031500500
2	102039	thermocouple, 320mm		1031500400
3	102247	thermocouple, 600mm, with break	FR7-4G/7G (I-series), FR9-2G13/22 (I-series), FR9-4G13/22 (I-series), FR7-4G/7G (II-series), FR9-2G13/22/22T (II-series), FR9-4G13/22/22T (II-series), F7-4G15/8G15, F9-4G15/22/22K, F9-8G15/22/22K, F9S-4G15/22, F9S-8G15/22	838323 1950100

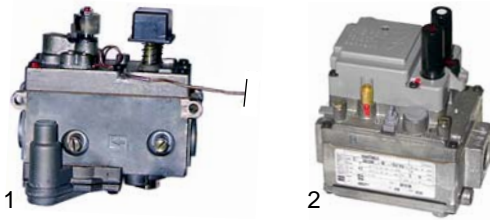

Item	Order	Description	Model	OEM
1	101431	Minisit controller	FQG-40/60 (I-series), FR7-4G/7G	1031500300 1743300 1743324
1	101437	Minisit controller	FQG-40/60 (II-series), FR9-2G13/4G13	1393300 1451000 1451024
2	101127	Elettrosit	FR9-2G22/4G22 (I-series)	1450100

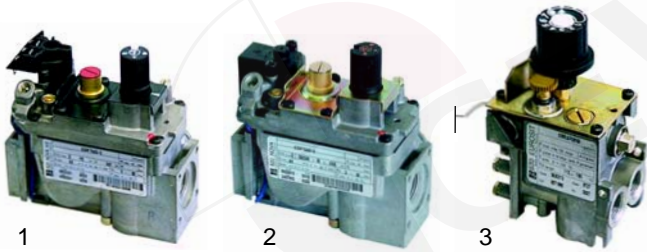

Item	Order	Description	Model	OEM
1	101187	Novasit (mV)	FR9-2G22/4G22 (II-series), F9-4G22/8G22, F9S-4G22/8G22	1870800
2	101908	Novasit (230V)	FR-2G22T/4G22T	1871200
3	101188	Eurosit controller	F7-4G15/8G15, F9-4G15/8G15, F9S-4G15/8G15	CM097000

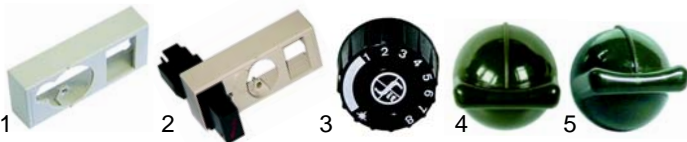

Item	Order	Description	Model	OEM
1	101137	cover		1393600
2	101136	cover with piezoelectric igniter	FR7-4G/7G, FR9-2G13, FR9-4G13	1393700
3	110068	knob		1393500
4	111501	knob		1036700400
5	110407	knob	FQG-40/60	1036702400



Item	Order	Description	Model	OEM
1	100073	pilot burner		1031027800
2	100703	electrode	FQG40/60 (I-series)	1031025700
3	100019	ignition cable		1047024600
4	100013	piezoelectric igniter		1031500600

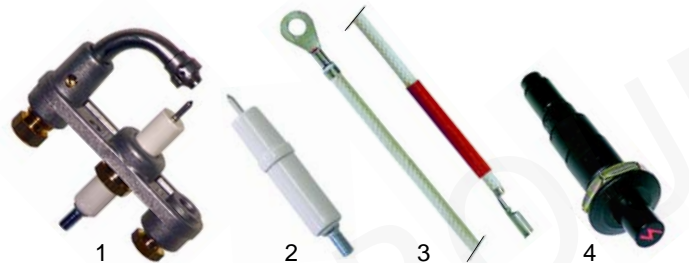

Item	Order	Description	Model	OEM
1	100073	pilot burner		509900
2	100703	electrode	FQG40/60 (II-series)	636700
3	100186	ignition cable		1936300
4	100009	piezoelectric igniter		1936100



Item	Order	Description	Model	OEM
1	100073	pilot burner	FR7-4G/7G (I-series)	411111
2	100703	electrode		636700
3	100199	ignition cable		1152700
4	100003	piezoelectric igniter		986000

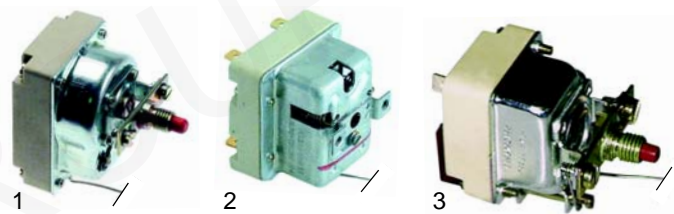

Item	Order	Description	Model	OEM
1	375323	safety thermostat	FQG-40/60 (I-series)	1031028000
2	375358	safety thermostat	FQG-40/60 (II-series), FR7-4G/7G (II-series), FR9-2G13/22/22T (II-series), FR9-40G13/22/22T (II-series)	1871100
3	390061	safety thermostat	FR7-4G/7G (I-series), FR9-2G13/22 (I-series), FR9-4G13/22 (I-series)	732913



Item	Order	Description	Model	OEM
1	100073	pilot burner	FR9-2G13 (I-series), FR9-4G13 (I-series)	411111
2	100703	electrode		636700
3	100025	ignition cable		1394600
4	100001	piezoelectric igniter		-

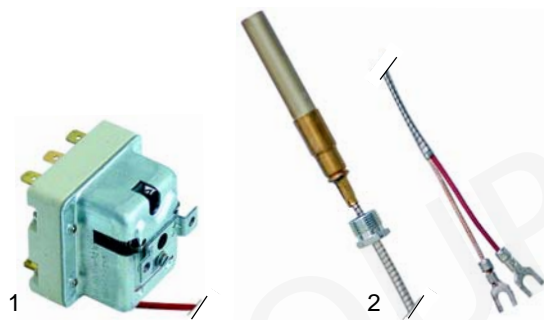

Item	Order	Description	Model	OEM
1	375359	safety thermostat	F7-4G15/8G15, F9-4G15/22/22K, F9-8G15/22/22K, F9S-4G15/22, F9S-8G15/22	CM097700
2	102116	MV generator	F9-2G22/4G22, F9-4G22/8G22, F9S-4G22/8G22	1870712

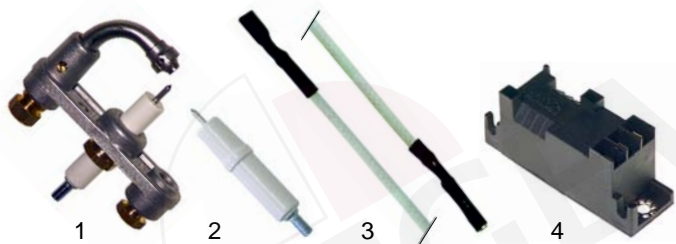

Item	Order	Description	Model	OEM
1	100073	pilot burner	FR9-2G22 (I-series), FR9-4G22 (I-series)	41111
2	100703	electrode		636700
3	100199	ignition cable		1152800
4	101002	ignition unit		1450300



Item	Order	Description	Model	OEM
1	390046	thermostat		1450914 1450900
2	300080	switch		710300
3	110386	knob	FR9-2G22 (I-series), FR9-4G22 (I-series)	1508100
4	110629	symbol		1322900
5	359160	signal lamp/green		1230300
6	359159	signal lamp/yellow		912800



Item	Order	Description	Model	OEM
1	100837	pilot burner/ upper part	FR7-4G/7G (II-series), FR9-2G13/22/22T (II-series), FR9-4G13/22/22T (II-series), F7-4G15/8G15,	1576000
2	100883	pilot burner/ lower part		1874100
3	100706	electrode	F9-4G15/22/22K,	224211
4	100186	ignition cable	F9-8G15/22/22K, F9S4G15/22,	1936300
5	100009	piezoelectric igniter	F9S8G15/22	1936100



Item	Order	Description	Model	OEM
1	390046	thermostat		1450914
2	110386	knob	FR9-2G22 (II-series),	1508100
3	110629	symbol	FR9-4G22 (II-series)	1322900

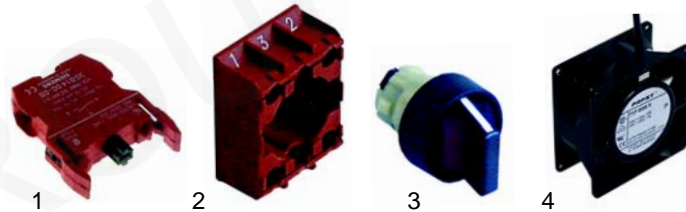

Item	Order	Description	Model	OEM
1	345525	logic element		2860900
2	345482	element holder	F9-4G22K,	2860700
3	345526	selector switch	F9-8G22K	2860600
4	601038	fan		CM250700

Fryers (electric)

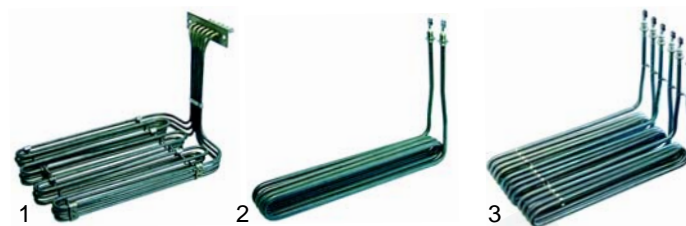

Item	Order	Description	Model	OEM
1	415090	5550 W/3 phases 230V	FQE-40, FQE-60, FRE-702/703	1037039900 1037039915 892900
1	415963	7250 W/3 phases 230V	FQE-40SP, FQE-60SP	1037301600 1037301615
2	415962	2000 W/230V	FQE41L (until4.'98), FQE61L (until4.'98), FR7-4E10L (until4.'98), FR7-7E10L (until4.'98), FR9-2E10L, FR9-4E10L	1037314944
2	415961	3000 W/230V	FQE41 (until4.'98), FQE61 (until4.'98), FR7-4E10 (until4.'98), FR7-7E10 (until4.'98), FR9-2E10	1037313044
3	416810	6000 W/3 phases 230V	FQE41L (from 5.'98), FQE61L (from 5.'98), FR74E10L (from 5.'98), FR77E10L (from 5.'98), FR9-2E10L, FR9-4E10L	1037317100
3	416811	9000 W/3 phases 230V	FQE41 (from 5.'98), FQE61 (from 5.'98), FR74E10 (from 5.'98), FR74E10 (from 5.'98), FR9-2E10	1037317200



Item	Order	Description	Model	OEM
1	415976	2300 W/230V	FR7-4E/7E (I-series)	1750000
2	415969	2400 W/230V	FR7-4E/7E (II-series)	1982700
3	415989	3000 W/230V	FR9-2E13/E13T (II-series), FR9-4E13/13T (II-series)	1982800

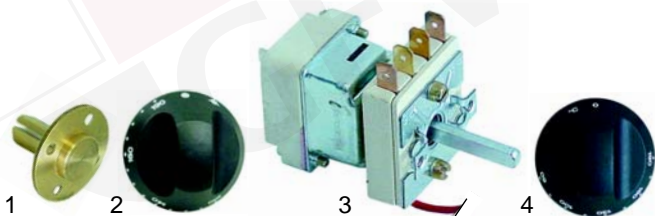

Item	Order	Description	Model	OEM
1	101816	adapter	F7-4G15/8G15,	CM057701
2	110415	knob	F9-4G15/8G15, F9S-4G15/8G15	CM062301
3	375331	thermostat with switch	F9-4G22/8G22,	CM097800
4	110410	knob	F9S-4G22/8G22	CM062200

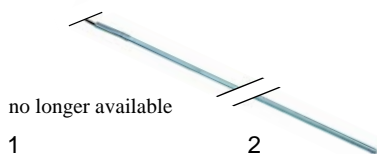

no longer available

Item	Order	Description	Model	OEM
1	no longer available	electronic controller	FR9-2G22T, FR9-4G22T	1479300 1479315
2	379387	sensor		1957600



Item	Order	Description	Model	OEM
1	345525	logic element, 1 NO		2860900
2	345482	element holder	FR9-2G22T, FR9-4G22T	2860700
3	345526	selector switch		2860600

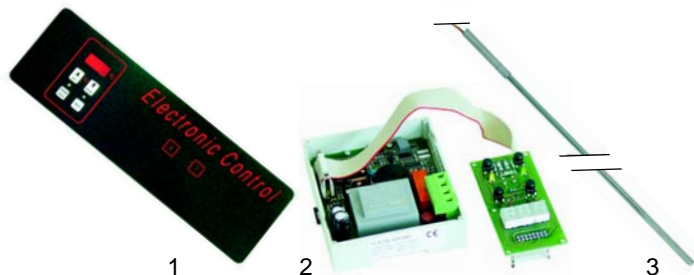

Item	Order	Description	Model	OEM
1	400688	fascia		CM247301
2	400687	electronic controller, compl.	F9-4G22K, F9-8G22K	CM295800
3	379388	sensor (J)		CM295900

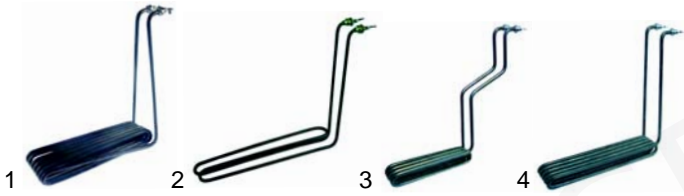

Item	Order	Description	Model	OEM
1	415990	5800W/230V	FR9-2E22/22T (II-series), FR9-4E22/22T (II-series)	1982900
2	415089	1850W/230V	FR-2E15, FR-4E15, FR-15E/E2	132522
3	415985	3000W/230V	FR9-2E13 (I-series), FR9-4E13 (I-series)	1463900 1466100
4	415986	5000W/230V	FR9-2E22 (I-series), FR9-4E22 (I-series)	1464000 1466200



Item	Order	Description	Model	OEM
1	416812	9000W/3 phases 230V	F7-__E10, F9-__E10	1037316600 1037316601
2	416813	9000W/3 phases 230V	F7-__E12, F9-__E12, F9S-__E12	CM032101
3	416814	9000W/3X230V	F9-__E18/18K, F9S-__E18/18K	CM032401



Item	Order	Description	Model	OEM
1	550496	O-ring		CM099200
2	550497	nut		CM021600



Item	Order	Description	Model	OEM
1	375410	thermostat	FQE40 (I-series), FQE60 (I-series), FQE40SP (I-series), FQE60SP (I-series)	1037101400 1037033300 1037033200



Item	Order	Description	Model	OEM
1	375198	thermostat	FQE40/40SP (II-series), FQE60/60SP (II-series), FQE41/41L, FQE61/61L, FR7-4E/7E (II-series), FR9-2E13/22 (II-series), FR9-4E13/22 (II-series)	1981900 1873500 921200 1037313200
2	550060	retainer		
3	300001	switch		



Item	Order	Description	Model	OEM
1	390046	thermostat	FR7-4E/7E (I-series), FR9-2E13/22 (I-series), FR9-4E13/22 (I-series)	1450900 1450914 921200
2	550060	retainer		710300
3	300080	switch		

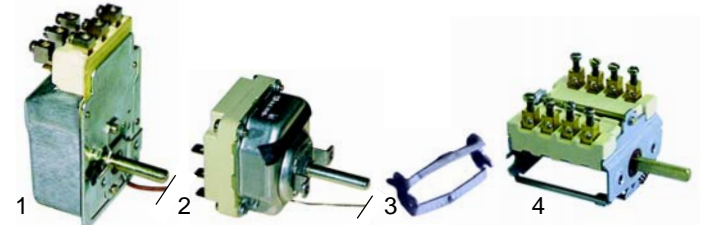

Item	Order	Description	Model	OEM
1	no longer available	thermostat		426011 893011
2	375410	thermostat	FRE-702, FRE-703, FR-2E15, FR-4E15, FR-15E	-
3	550060	retainer		921200
4	300080	switch		



Item	Order	Description	Model	OEM
1	110405	knob		1036700500
2	110408	knob		1036702200
3	110362	knob	FQE (I-series) (600 series)	1036700900
4	110611	symbol		1039107200



Item	Order	Description	Model	OEM
1	110463	knob		1036700700
2	110360	knob	FQE (II-series) (600-series)	1840700
3	110611	symbol		1039107200

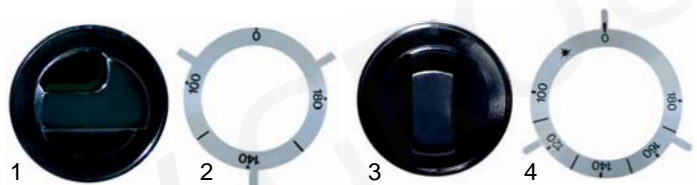

Item	Order	Description	Model	OEM
1	110360	knob		1840700
2	110612	symbol	FR7- (700-series)	1840600
3	110386	knob		1508100
4	110629	symbol	FR9 (900-series)	1322900

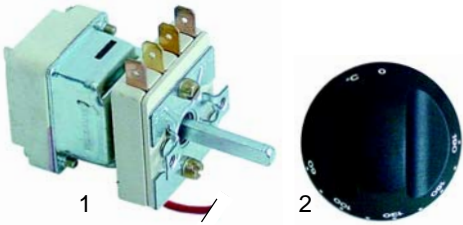

Item	Order	Description	Model	OEM
1	375331	thermostat/switch combination	F7- __, F9- __	CM097800
2	110410	knob		CM062200

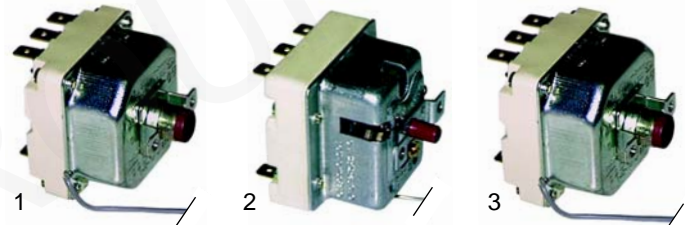

Item	Order	Description	Model	OEM
1	375104	safety thermostat	FQE (I-series)	1037035900
2	375189	safety thermostat	FQE (II-series), FR7-4E/7E (II-series), FR9-4E/7E (II-series)	1878600 1982000
3	390066	safety thermostat	FRE-702/703	893100

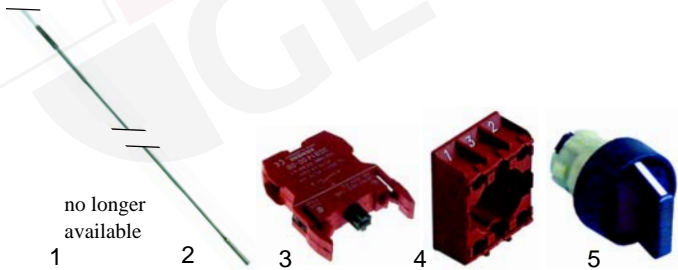

Item	Order	Description	Model	OEM
1	n. l. a.	electronic controller		1479315
2	379389	sensor	FR9-2E13T, FR9-4E13T,	1567015
3	345525	logic element	FR9-2E22T,	2860900
4	345482	element holder	FR9-4E22T	2860700
5	345526	selector switch		2860600

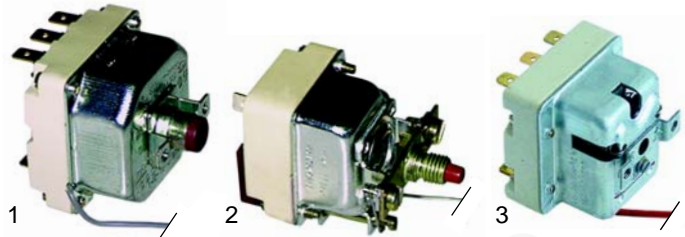

Item	Order	Description	Model	OEM
1	390168	safety thermostat	FR2E15/4E15, FR15E	733100
2	390061	safety thermostat	FR7-4E/7E (I-series), FR9-4E/7E (I-series)	732913
3	375359	safety thermostat	F7- (Predagonista), F9- (Predagonista), F9S- (Predagonista)	CM097700

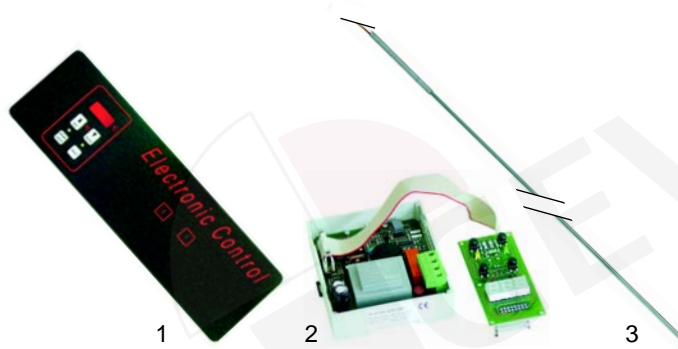

Item	Order	Description	Model	OEM
1	400688	fascia		CM247301
2	400687	electronics complete	F9-4E18K, F9-8E18K	CM295800
3	379388	sensor		CM295900

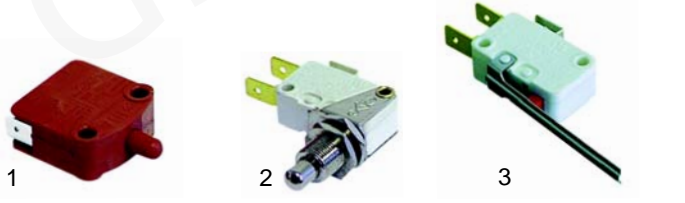

Item	Order	Description	Model	OEM
1	345060	micro switch	FQE, FR7-4E10/7E10, FR9-2E10/4E10	1037312900
2	345032	micro switch	FR7-4E/7E, FR9-2E/4E	1267300
3	345254	micro switch	F7-, F9-	1037111300

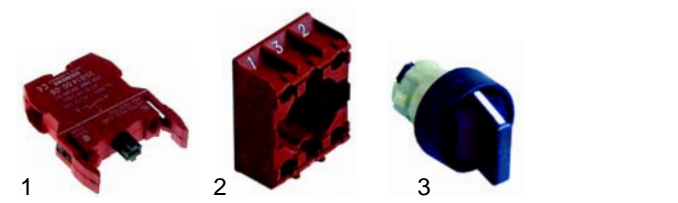

Item	Order	Description	Model	OEM
1	345525	logic element		2860900
2	345482	element holder	F9-4E18K, F9-8E18K	2860700
3	345526	selector switch		2860600



Item	Order	Description	Model	OEM
1	359160	signal lamp/green	FRE-702/703,	1230300
2	359159	signal lamp/yellow	FR2E15/4E15, FR15, FR9 (I-series)	912800
3	359139	signal lamp/green	FQE- __, FR7-4E/7E (II-series), FR9- (II-series),	1037300800 1037300810
4	359140	signal lamp/yellow	F7- (Predagonista), F9- (Predagonista)	1037300900 1037300910

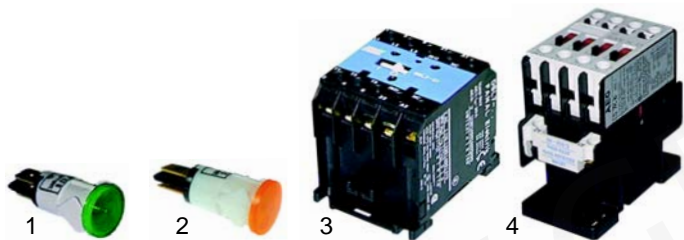

Item	Order	Description	Model	OEM
1	359142	signal lamp/green	FR7-4E/7E (I-series)	21016199
2	359143	signal lamp/yellow		21016299
3	380213	contactor	FQE, FR7, F7-, F9-E12	21453199 21450299 CM187300
4	380261	contactor	FR9, F9-E18	21407999 21453599 CM187400



Item	Order	Description	Model	OEM
1	514056	drain tap	FR7-__ (Predagonist)	1950700
2	514220	drain pipe	FR9-__ (Predagonist)	CM012000

Fryers (mechanical)

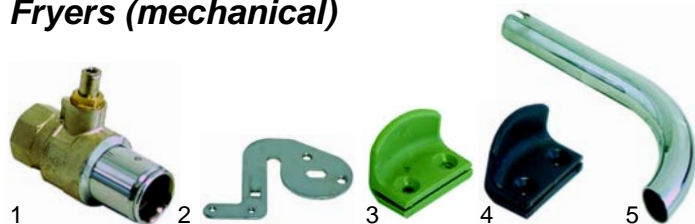

Item	Order	Description	Model	OEM
1	514005	drain tap		1031024110 1031024100
2	514007	lever joint/left		1044109600
3	514008	lever handle	FQG-, FQE	1036700000
4	514015	lever handle		1036702000
5	514006	drain pipe		1033061900 1033300300

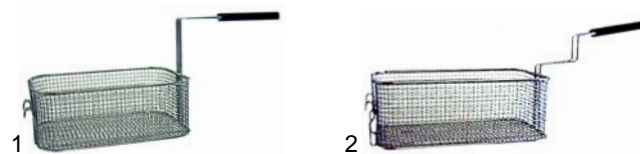

Item	Order	Description	Model	OEM
1	970156	basket	FQG-__ (I-series), FQE-__ (I-series)	1031004810
2	970198	basket	FQG- (II-series), FQE- (II-series), FR7-__10, FR9-__10, F7-__10, F9-__10	1031110222 1031110200



Item	Order	Description	Model	OEM
1	514011	lever joint/right	FQG-FQE (II-series)	1031400100
2	514012	drain tap	FR7-__G/E, FR9-__G/E (I-series)	1450500



Item	Order	Description	Model	OEM
1	970170	basket	FR7, FR9-__13	14647-12 93234-00
2	970171	basket	FR9-__22	1464600 9323300



Item	Order	Description	Model	OEM
1	514056	drain tap	FR7-__G (II-series), FR9-__G (II-series)	1950700
2	514218	drain tap	FR7-__E (II-series)	1577400
3	514219	drain pipe	FR9-__E (II-series), FR7-__G/E (II-series), FR9-__G/E (II-series)	1577500

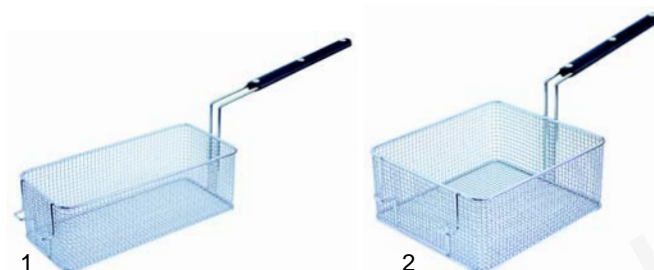

Item	Order	Description	Model	OEM
1	970352	basket	F7-__G15/E12, F9-__G15/E12	CM030400
2	970353	basket	F9-__G22/E18	CM030200

M

Tilting bratt pans (gas)



Item	Order	Description	Model	OEM
1	104154	burner	BR70-7G/7GI	1685400
2	104153	burner	BR9-4G/GI, BR9M-4G/GI, BR9-6G/GI, BR9M-6G/GI	1475100



Item	Order	Description	Model	OEM
1	102041	thermocouple		90520
2	100073	pilot burner	BR70/7G (I-series)	411111
3	100703	electrode		636700



Item	Order	Description	Model	OEM
1	105519	burner	BR7-8GF/GI	CM069900 CM069901
2	105520	burner	BR9-8GF/GI, BR9-8GFM/GIM	CM070003
3	105521	burner	BR9-12GFM, BR9-12GIM	CM070100 CM070103



Item	Order	Description	Model	OEM
1	100199	ignition cable		1152500
2	100003	piezoelectric igniter	BR70/7G (I-series)	986000
3	102111	ignition gas line, PU 3m		1690200

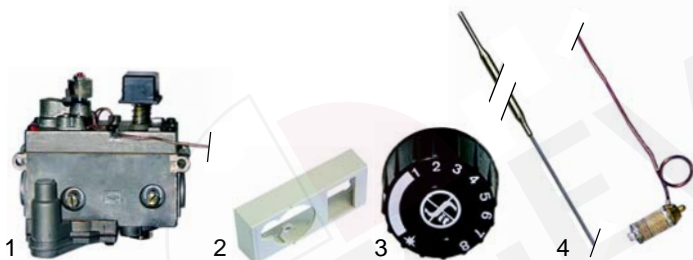

Item	Order	Description	Model	OEM
1	101438	Minisit controller		1685500 139300
2	101137	cover	BR70/7G (I-series)	1393600
3	110068	knob		1393500
4	102102	sensor		24021699

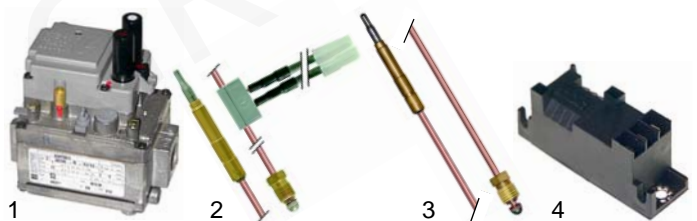

Item	Order	Description	Model	OEM
1	101127	Elettrosit gas valve		1450100
2	102247	thermocouple	BR9-4G/GI, BR9-6G/GI,	838323
3	102042	thermocouple	BR9M-4G/GI, BR9M-6G/GI	2716500
4	101002	ignition unit		1450300

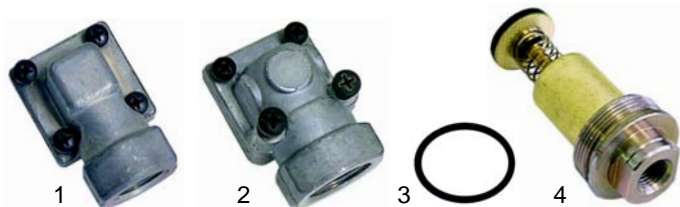

Item	Order	Description	Model	OEM
1	101268	angle, 3/8"		1393800
2	101269	angle, 1/2"	BR70/7G (I-series)	1393900
3	100809	O-ring		1394000
4	101053	solenoid coil		24021499



Item	Order	Description	Model	OEM
1	100073	pilot burner	BR9-4G/GI, BR9-6G/GI,	411111
2	100703	electrode	BR9M-4G/GI, BR9M-6G/GI	636700
3	102156	ignition cable, 400mm		1152800



Item	Order	Description	Model	OEM
1	101303	flange/straight	BR9-4G/GI, BR9-6G/GI,	1451300
2	101304	flange/elbow	BR9M-4G/GI,	1451200
3	101502	O-ring	BR9M-6G/GI	24040599



Item	Order	Description	Model	OEM
1	101125	Eurosit controller		1887600
2	101392	adapter		1868600
3	101390	spindle	BR70-7G/GI (II-series)	1905525
4	110360	knob		1840700
5	110437	symbol		1804800



Item	Order	Description	Model	OEM
1	101352	solenoid coil	BR9-4G/GI, BR9-6G/GI,	
2	101312	micro switch	BR9M-4G/GI, BR9M-6G/GI	1454900
3	101470	safety valve	BR9-6G/GI BR9M-6G/GI	1491900



Item	Order	Description	Model	OEM
1	100859	pilot burner		1887700
2	100701	electrode	BR70-7G/GI (II-series)	1888300
3	100186	ignition cable		1936300
4	100009	piezoelectric igniter		1936100

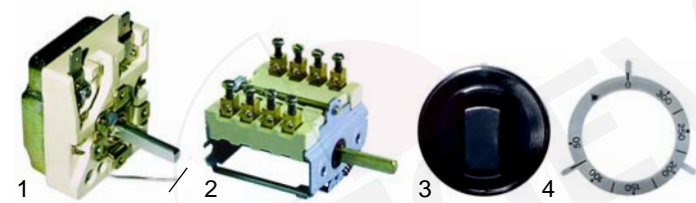

Item	Order	Description	Model	OEM
1	375202	thermostat		643800
2	300080	switch	BR9-4G/GI, BR9-6G/GI,	710300
3	110386	knob	BR9M-4G/GI,	1508100
4	110635	symbol	BR9M-6G/GI	1322500



Item	Order	Description	Model	OEM
1	101162	Novasit gas valve		2863300
2	101391	adapter	BR9-4G/GI, BR9M-4G/GI,	1923500
3	110386	knob	BR9SB-4G/GI,	1508100
4	110621	symbol	BR9M-6G/GI	1875100

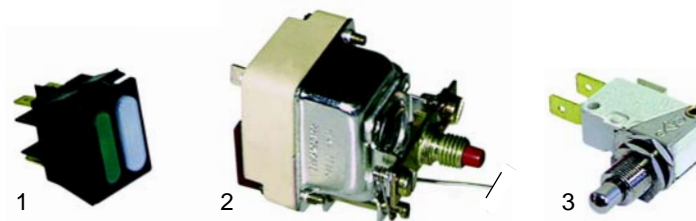

Item	Order	Description	Model	OEM
1	359164	signal lamp/double	BR9-4G/GI, BR9-6G/GI,	1314400
2	375194	safety thermostat	BR9M-4G/GI, BR9M-6G/GI	1266500 1266514
3	345032	micro switch		1267300



Item	Order	Description	Model	OEM
1	101305	flange/straight		2865700
2	101306	flange/elbow	BR9-4G/GI, BR9M-4G/GI,	2865800
3	101313	solenoid coil	BR9SB-4G/GI, BR9M-6G/GI	-
4	101317	plug with cable		1880600

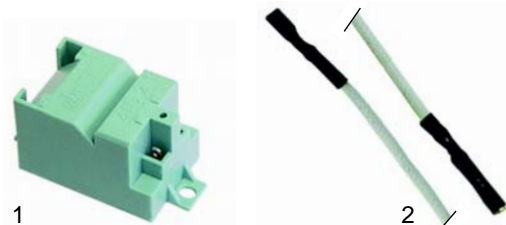

Item	Order	Description	Model	OEM
1	101012	ignition unit	BR9-4G/GI,	2971400
2	102155	ignition cable	BR9M-4G/GI, BR9SB-4G/GI, BR9M-6G/GI	

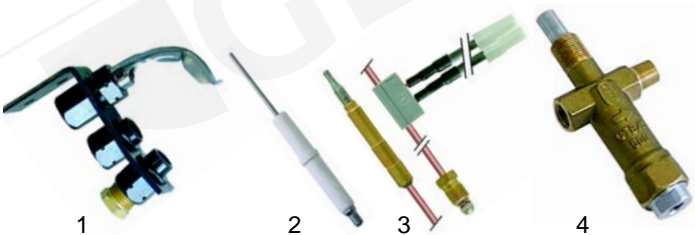

Item	Order	Description	Model	OEM
1	100859	pilot burner	BR9-4G/GI,	1887700
2	100701	electrode	BR9M-4G/GI,	1888300
3	102247	thermocouple	BR9M-6G/GI	1955500
4	101470	safety valve	BR9M-6G/GI	1491900



Item	Order	Description	Model	OEM
1	375002	thermostat	BR9-4G/GI,	1037102300
2	550060	retainer	BR9M-4G/GI,	921200
3	300080	switch	BR9SB-4G/GI, BR9M-6G/GI	710300

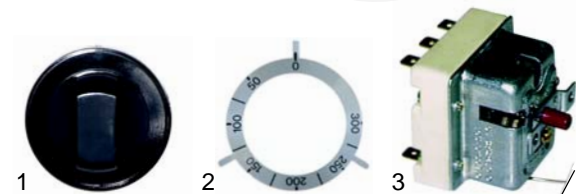

Item	Order	Description	Model	OEM
1	110386	knob	BR9-4G/GI,	1508100
2	110631	symbol	BR9M-4G/GI,	1323300
3	375187	safety thermostat	BR9SB-4G/GI, BR9M-6G/GI	1878500



Item	Order	Description	Model	OEM
1	101125	Eurosit controller		1887600
2	101816	adapter	BR7-8GF,	CM057701
3	110460	knob	BR7-8GI	CM062401
4	102042	thermocouple		CM029100



Item	Order	Description	Model	OEM
1	100050	pilot burner		CM029000
2	100701	electrode	BR7-8GF,	1888300
3	100019	ignition cable	BR7-8GI	1936400
4	100009	piezoelectric igniter		1936100



Item	Order	Description	Model	OEM
1	101162	Novasit gas valve		2863300
2	101817	adapter	BR9-8GF/GI, BR9-__GFM/GIM,	CM091301 CM091302
3	110440	knob	BR9S-8GF/GI	CM061501
4	102247	thermocouple		1950100



Item	Order	Description	Model	OEM
1	100050	pilot burner		CM029000
2	100701	electrode	BR9-8GF/GI,	1949900
3	100019	ignition cable	BR9-__GFM/GI	1936400
4	100009	piezoelectric igniter	BR9S-8GF/GI	1936100

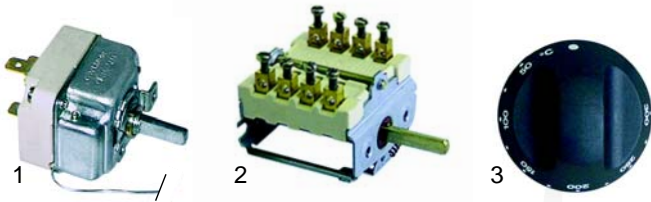

Item	Order	Description	Model	OEM
1	375002	thermostat	BR9-8GF/GI,	1037102300
2	300080	switch	BR9-__GFM/GIM,	710300
3	110998	knob	BR9S-8GF/GI	CM059800



Item	Order	Description	Model	OEM
1	300102	switch		1475900
2	110360	knob		1840700
3	110604	symbol	BR70-7E (I-series)	1229000
4	359142	signal lamp/green		21016199
5	359143	signal lamp/yellow		21016299

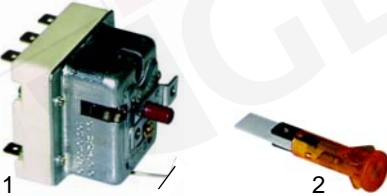

Item	Order	Description	Model	OEM
1	375187	safety thermostat	BR9-8GF/GI,	1878500
2	359140	signal lamp	BR9-__GFM/GIM, BR9S-8GF/GI	1037300910

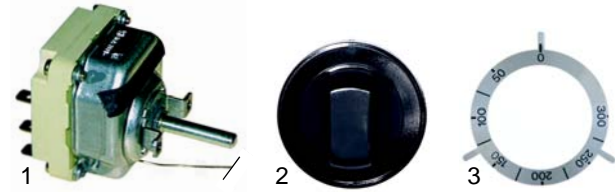

Item	Order	Description	Model	OEM
1	375192	thermostat		1309100
2	110386	knob	BR9-4E, BR9-6E	1508100
3	110631	symbol		1323300

Tilting bratt pans (electric)

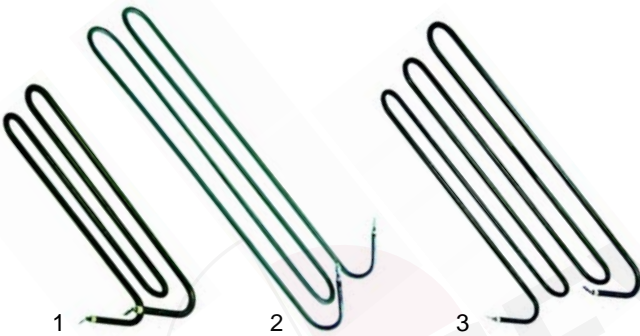

Item	Order	Description	Model	OEM
1	415973	2700W/230V	BR70-7E, BR7-8E	1686900 1685100
2	415084	3900W/230V	BR9-4E, BR9-8E	1878700 1475600
3	415987	5850W/230V	BR9-6E, BR9-12E	1493800 1878800



Item	Order	Description	Model	OEM
1	300102	switch		1475900
2	110386	knob	BR9-4E, BR9-6E	1508100
3	110624	symbol		1323700
4	359164	signal lamp		1314400

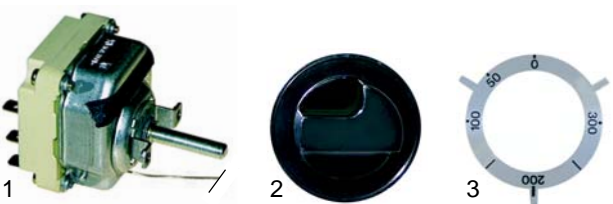

Item	Order	Description	Model	OEM
1	375192	thermostat		1309100
2	110360	knob	BR70-7E (I-series)	1840700
3	110614	symbol		1840400



Item	Order	Description	Model	OEM
1	375002	thermostat	BR70-7E/7EI	1037102300
2	550060	retainer	(II-series) BR9-4/6__	1998500 921200
3	300001	switch	(II-series) BR9-8__/12__	1037313200

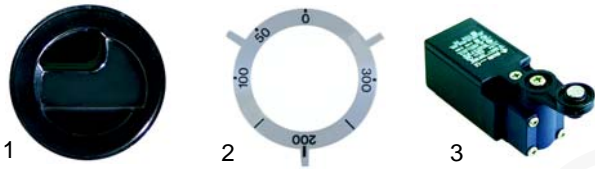

Item	Order	Description	Model	OEM
1	110360	knob		1840700
2	110614	symbol	BR70-7E/7EI (II-series)	1840400
3	345144	limit switch		1871500

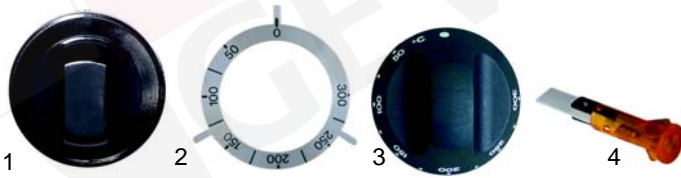

Item	Order	Description	Model	OEM
1	110386	knob	BR9-4_/6_	1508100
2	110631	symbol	(II-series)	1323300
3	110998	knob	BR7-_/	CM059800
4	359140	signal lamp/yellow	BR9-8_/6_	1037300910



Item	Order	Description	Model	OEM
1	375187	safety thermostat		1878500
2	380213	contactor	universal	CM187300 21453199
3	380261	contactor		CM187400 21453599

Tilting bratt pans (mechanical)



Item	Order	Description	Model	OEM
1	514028	hinge	BR70-	1488600
2	514029	hinge pin	BR9-	1488800
3	514030	seeger circlip ring		15901700

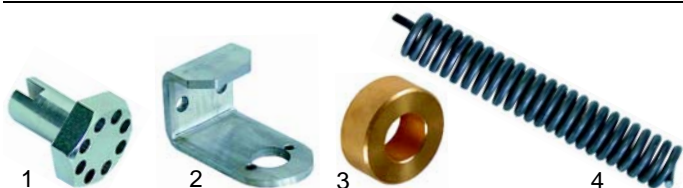

Item	Order	Description	Model	OEM
1	514223	setting bush		291100
2	514224	hinge holder	BR70- BR9-	1489000
3	514225	bush		290900
4	514226	lid spring		139732

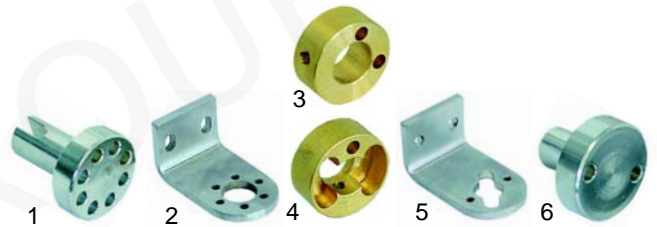

Item	Order	Description	Model	OEM
1	514227	setting bush/right		CM051604
2	514228	hinge holder/right		CM192401
3	514229	bush/right	BR70- BR9- (Predagonista)	CM192101
4	514232	bush/left		CM051403
5	514230	hinge holder/left		CM051903
6	514231	setting bush/left		CM051503



Item	Order	Description	Model	OEM
1	514226	lid spring/outer	BR70- BR9- (Predagonista)	139732
2	514234	lid spring/center		810210



Item	Order	Description	Model	OEM
1	514235	tilting mechanism complete		1687600
2	514023	nut, M20, left	BR70-	1685800
2	514024	nut, M20, right		1688000
3	514026	hand wheel		1685600 1685691



Item	Order	Description	Model	OEM
1	514236	tilting mechanism compl.		1478432
2	514023	nut, M20, left	BR9-	1685800
2	514024	nut, M20, right		1688000
3	690086	hand wheel		1475200
4	n.l.a.	nut, M24	BR9- (I-series)	1479000

no longer available



Item	Order	Description	Model	OEM
1	514237	nut	BR7 (Predagonist) BR9 (Predagonist)	CM184300
2	514238	shaft	BR7 (Predagonis)	CM199100
3	514239	shaft	BR9 (Predagonist)	CM199200
4	514240	bush		CM184500
5	514241	shaft hand wheel	BR7 (Predagonist) BR9 (Predagonist)	CM184800
6	690086	hand wheel		CM1475291

Boiling pans (gas)



Item	Order	Description	Model	OEM
1	105276	burner cover	P__70G-7G P9__-5G	1205900 1104400
2	105277	burner body		1104300
3	104151	burner	P9__-10G/15G (I-series)	1413000
4	104244	burner	P9__-10G (II-series)	27085-14



Item	Order	Description	Model	OEM
1	105522	burner	P__-6G5	CM088200
2	105523	burner	P__-8G10/14/15	CM088100



Item	Order	Description	Model	OEM
1	101089	gas tap		1337200
2	110364	knob	PD70-7G (I-series)	1840900
3	110601	symbol		1842000

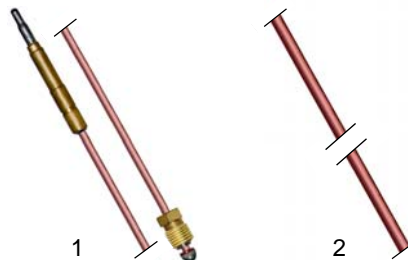

Item	Order	Description	Model	OEM
1	102041	thermocouple	PD70-7G (I-series)	90520
2	102110	ignition gas line(PU 3 m)		1682300



Item	Order	Description	Model	OEM
1	101060	solenoid coil		24030199
2	101230	magnetic nut	PD70-7G (I-series)	24030299
3	101260	bolt with slot		1359100
4	101246	olive, 4mm		673600
5	100908	screw, M10		673500



Item	Order	Description	Model	OEM
1	101248	olive, 12mm		673100
2	101251	union nut, M20		673300
3	100907	thermocouple screw	PD70-7G (I-series)	24010899
4	101292	electrode screw		636600
5	101282	olive		469000
6	101283	screw, M10		468800



Item	Order	Description	Model	OEM
1	101437	Minisit controller	PI70-7G	1393300 1677300
2	101137	cover		1393600
3	110068	knob		1393500

M

Suitable for Mareno

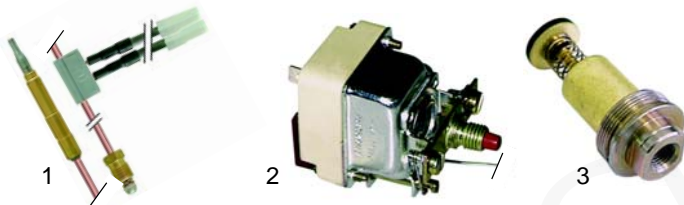

Item	Order	Description	Model	OEM
1	102247	thermocouple	PI70-7G	838323
2	390061	safety thermostat		732913
3	101053	solenoid coil		24021499



Item	Order	Description	Model	OEM
1	101127	Elettrosit controller	P9I-10G	1450100
2	102042	thermocouple		2716500
3	102011	thermocouple extension, 400mm		933400

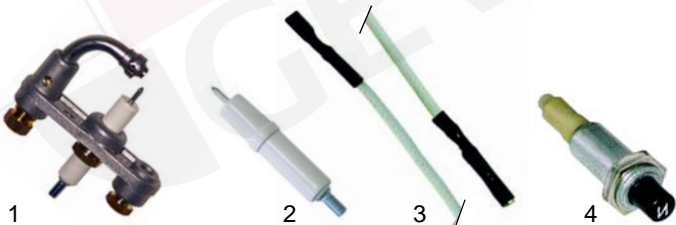

Item	Order	Description	Model	OEM
1	100073	pilot burner	PD70-7G PI70-7G	509900
2	100703	electrode		636700
3	100199	ignition cable		1152500
4	100003	piezoelectric igniter		986000

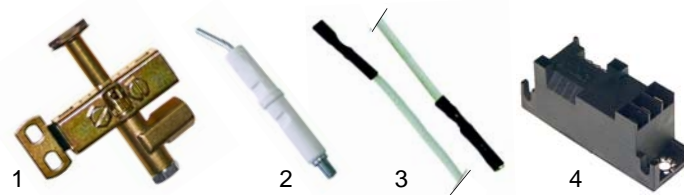

Item	Order	Description	Model	OEM
1	100046	pilot burner	P9I-10G	10405-11
2	100706	electrode		224211
3	102157	ignition cable, 1200mm		1152900
4	101002	ignition unit		1450300



Item	Order	Description	Model	OEM
1	101093	gas tap	P9D-10G/15G	1345300
2	110388	knob		1322200
3	110620	symbol		1322300



Item	Order	Description	Model	OEM
1	390046	thermostat	P9I-10G	1450200
2	300080	switch		710300
3	110386	knob		1508100
4	110632	symbol		1875300

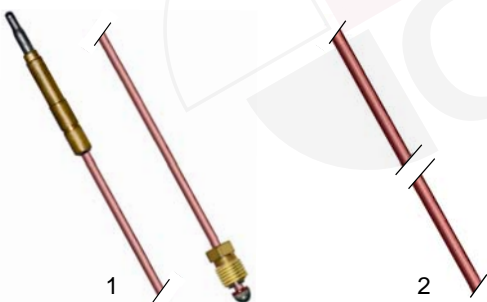

Item	Order	Description	Model	OEM
1	102044	thermocouple, 1200mm	P9D-10G/15G	263800
2	102110	ignition gas line (*PU 3 m)		1413100 1413200

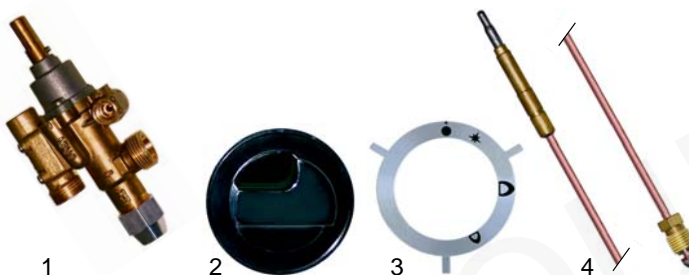

Item	Order	Description	Model	OEM
1	101086	gas tap	PD70-7G (II-series)	188860
2	110364	knob		1840900
3	110601	symbol		1842000
4	102042	thermocouple, 850mm		1916000

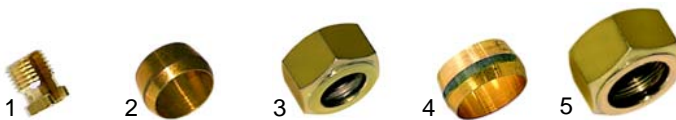

Item	Order	Description	Model	OEM
1	101262	bolt with slot, M10	P9D-10G/15G	1162800
2	101256	olive 16		1127400
3	101253	union nut M24/16		1421000
4	101257	olive 20		1347000
5	101254	union nut M28/20		1346900

*PU: Packaging Unit

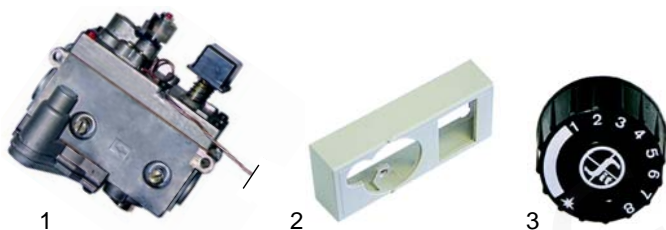

Item	Order	Description	Model	OEM
1	101437	Minisit controller	PI70-7G (II-series)	1677314
2	101137	cover	P9I-5G	1693600
3	110068	knob		1693500



Item	Order	Description	Model	OEM
1	100859	pilot burner	PD70-7G (II-series)	1887700
2	100701	electrode	PI70-7G (II-series)	1888300
3	100019	ignition cable	P9I-5G	1936400
4	100009	piezoelectric igniter	P9D-10G/15G (II-series)	1936100



Item	Order	Description	Model	OEM
1	102247	thermocouple	PI70-7G (II-series)	1955500
2	375358	safety thermostat	P9I-5G	1871100



Item	Order	Description	Model	OEM
1	101187	Novasit gas valve		1870800
2	101391	adapter	P9I-10G	1923500
3	110386	knob		1508100
4	110621	symbol		1875100

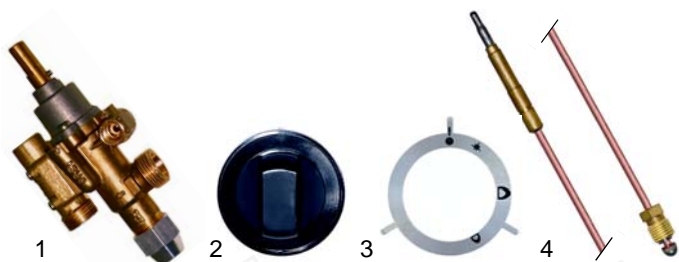

Item	Order	Description	Model	OEM
1	101086	gas tap		1888600
2	110388	knob	P9D-5G	1322200
3	110620	symbol		1322300
4	102042	thermocouple		1916000



Item	Order	Description	Model	OEM
1	102238	thermocouple		1949800
2	102116	generator	P9I-10G	1870712
3	375358	safety thermostat		1871100



Item	Order	Description	Model	OEM
1	101093	gas tap		1954600
2	110388	knob	P9D-10G/15G (II-series)	1322200
3	110620	symbol		1322300
4	102044	thermocouple		263800

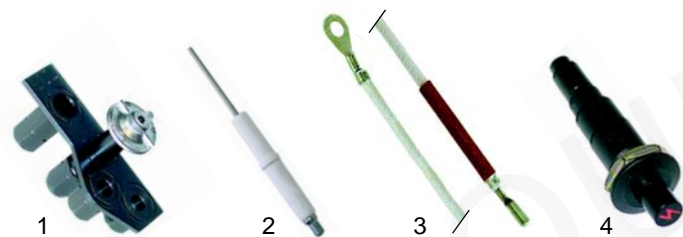

Item	Order	Description	Model	OEM
1	100110	pilot burner		1949700
2	100701	electrode	P9I-10G	1949900
3	100195	ignition cable		1950312 1950324
4	100009	piezoelectric igniter		1936100



Item	Order	Description	Model	OEM
1	375198	thermostat	P9I-10G	1873500
2	110386	knob		1508100
3	110632	symbol		1875300



Item	Order	Description	Model	OEM
1	375331	thermostat with switch	PI9-8G10/14	CM097800
2	110410	knob		CM062200
3	101189	tandem valve		29426001



Item	Order	Description	Model	OEM
1	101086	gas tap	PD7-6G5 PD9-6G5	1888600
2	110993	knob		CM061600
3	102042	thermocouple		CM029100



Item	Order	Description	Model	OEM
1	100109	pilot burner	PD7- PI7- PD9- PI9- —	CM040800
2	100701	electrode		1888300
3	100019	ignition cable		1936400
4	100009	piezoelectric igniter		1936100
5	101818	cover		CM136000



Item	Order	Description	Model	OEM
1	101188	Eurosit controller	PI7-6G5 PI9-6G5	CM097000
2	101816	adapter		CM057700 CM057701
3	110415	knob		CM062301

Boiling pans (electric)



Item	Order	Description	Model	OEM
1	415994	3400W/3 phases 230V	PI70-7E	1677000 1878100
2	521115	gasket		2604100
3	415984	6000W/3 phases 230V	P9I-10E	1878200 1414300
4	521116	gasket		1422200

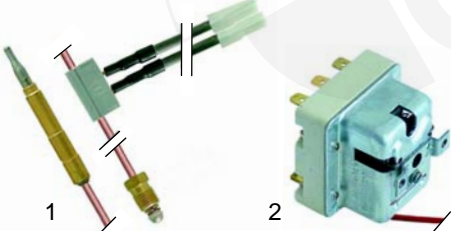

Item	Order	Description	Model	OEM
1	102247	thermocouple		1950100
2	375359	safety thermostat		CM097700

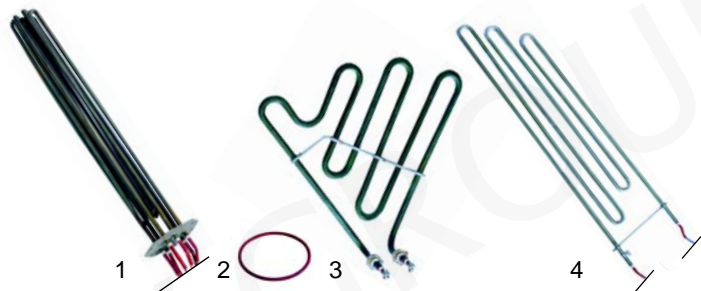

Item	Order	Description	Model	OEM
1	416815	7500W/3 phases 230V	P9I-15E	1878300
2	521116	gasket		1422200
3	416816	2000W/230V	P9D-10E/15E	1414400 1879000
4	416817	4000W/230V	PD9-8E10/15	CM096301



Item	Order	Description	Model	OEM
1	101093	gas tap	PD9-8G10/15 PI9-8G10/14	1954600
2	110993	knob		CM061600
3	102042	thermocouple		CM029100

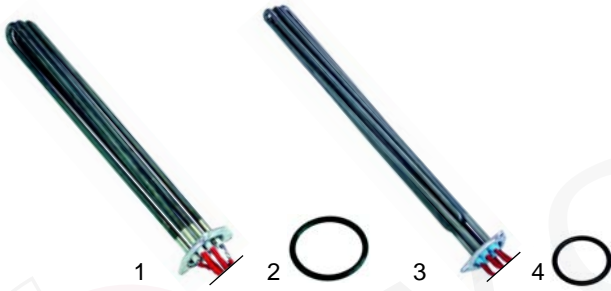

Item	Order	Description	Model	OEM
1	416818	3400W/3 phases 230V	PI7-6E5	CM183900
2	521146	gasket	PI9-6E5	CM046200
3	416819	7500W/3 phases 230V	PI9-8E10/15	CM182300
4	521115	gasket		2604100

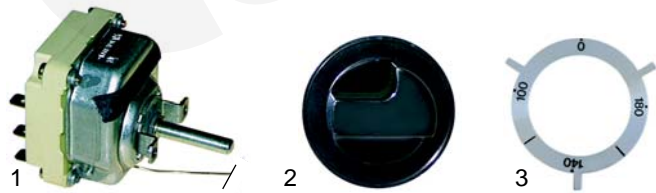

Item	Order	Description	Model	OEM
1	375410	thermostat		1616000
2	110360	knob	PI70-7E (I-series)	1840700
3	110612	symbol		1840600



Item	Order	Description	Model	OEM
1	300021	switch		1230100
2	110360	knob	PI70-7E (I-series)	1840700
3	110604	symbol		1229000



Item	Order	Description	Model	OEM
1	390168	safety thermostat		733100
2	359142	signal lamp/green	PI70-7E (I-series)	1819800
3	359143	signal lamp/yellow		1819900

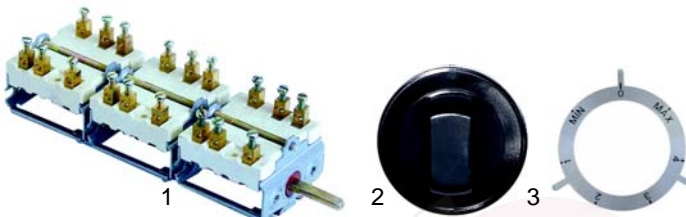

Item	Order	Description	Model	OEM
1	345710	switch		1419700
2	110386	knob	P9D-10E/15E (I-series)	1508100
3	110627	symbol		1966800

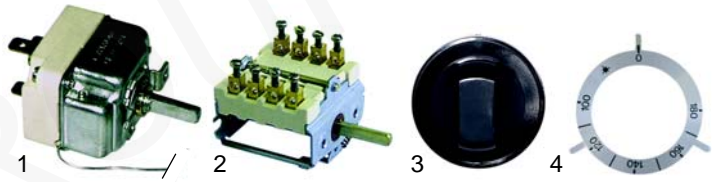

Item	Order	Description	Model	OEM
1	390046	thermostat		1450200
2	300080	switch	P9I-10E	710300
3	110386	knob		1508100
4	110629	symbol		1322900

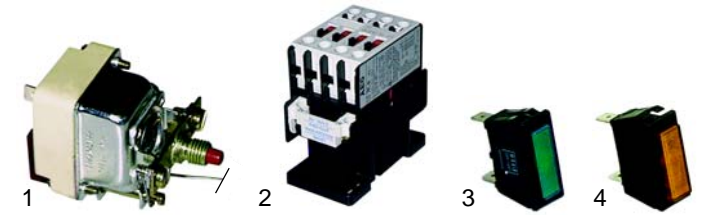

Item	Order	Description	Model	OEM
1	390061	safety thermostat		732913
2	380261	contactor	P9I-10E	21452399
3	359160	signal lamp/green		1230300
4	359159	signal lamp/yellow		912800

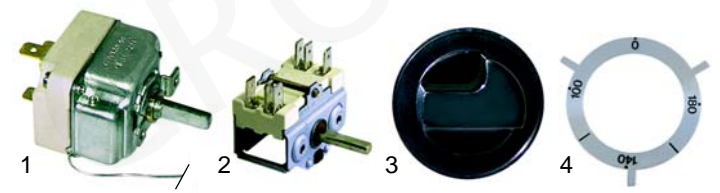

Item	Order	Description	Model	OEM
1	375198	thermostat		1873500
2	300001	switch	PI70-7E (II-series)	1037313200
3	110360	knob		1840700
4	110612	symbol		1840600

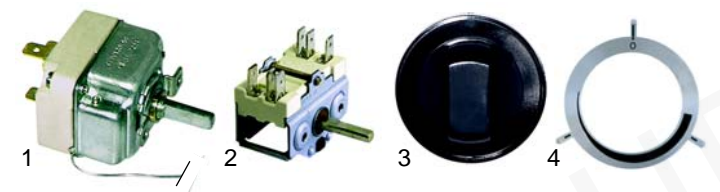

Item	Order	Description	Model	OEM
1	375198	thermostat		1873500
2	300001	switch	P9I-5E/10E/15E	1037313200
3	110386	knob		1508100
4	110632	symbol		1875300



Item	Order	Description	Model	OEM
1	375189	safety thermostat		1878600
2	380213	contactor	PI70-7E (II-series)	21453199
3	359139	signal lamp/green	P91-5E	1037300810
4	359140	signal lamp/yellow		1037300910



Item	Order	Description	Model	OEM
1	375331	thermostat, with switch	PI7-6E5	CM097800
2	110410	knob	PI9-6E5 PI9-8E10/15	CM62200
3	380015	energy regulator	PD9-8E10/15	426710
4	110995	knob		CM062500

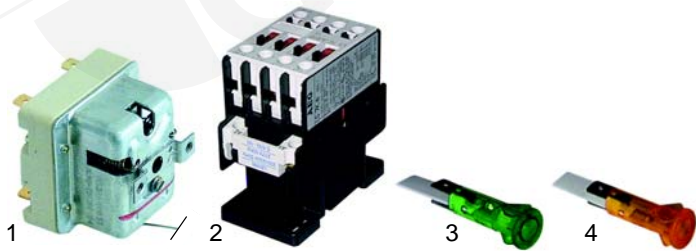

Item	Order	Description	Model	OEM
1	375358	safety thermostat		1871100
2	380261	contactor	P91-10E/15E	21453599
3	110139	signal lamp/green		1037300810
4	110140	signal lamp/yellow		1037300910

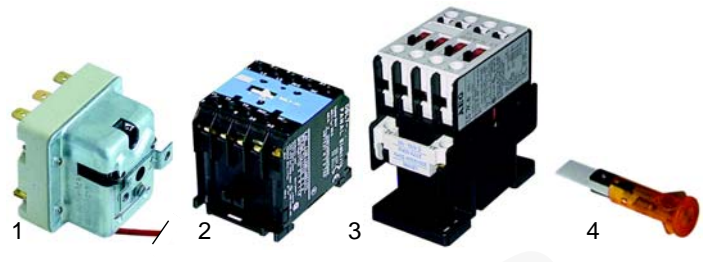

Item	Order	Description	Model	OEM
1	375359	safety thermostat	PI7-6E5	CM097700
2	380213	contactor	PI9-6E5	CM187300
3	380261	contactor	PI9-8E10/15 PD9-8E10/15	CM187400
4	359140	signal lamp/yellow		1037300910



Item	Order	Description	Model	OEM
1	380015	energy regulator		426710
2	110386	knob	P9D-10E/15E	1508100
3	110627	symbol		1966800

Boiling pans (mechanical)



Item	Order	Description	Model	OEM
1	540132	drain tap 1 1/4"	PD70-7G PI70-7G/E P9_-5G/E	1677800 1677200
2	540275	drain tap 2"	P9_-10G/E P9_-15G/E PD-10G/15G PI-10G/15G/10E	679400 679412

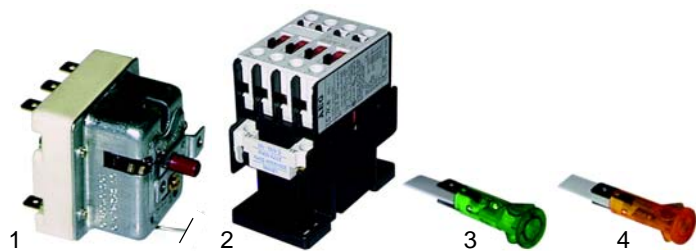

Item	Order	Description	Model	OEM
1	375187	safety thermostat		1878500
2	380261	contactor	P9D-10E/15E	21453599
3	359139	signal lamp/green		1037300810
4	359140	signal lamp/yellow		1037300910



Item	Order	Description	Model	OEM
1	540721	safety valve, 1 1/4"		14206200 14206299
2	540827	pressure relief valve, 3/4"	PI-10G, PI-15G, PI-10E	14206399
3	540836	funnel		14206599



Item	Order	Description	Model	OEM
1	514242	mixer tap	P9D-__, P9I-__	450100
2	514243	inlet pipe	P9D-__, P9I-__, PD9-__, PI9-__	450000

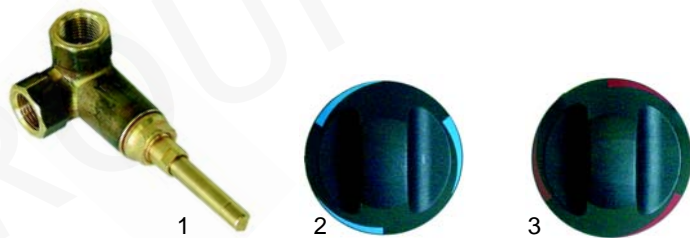

Item	Order	Description	Model	OEM
1	514060	inlet tap		CM127800
2	514061	knob		CM143100
3	514245	knob		CM143200



Item	Order	Description	Model	OEM
1	514244	upper part		955600
2	514053	handle	P9D-__, P9I-__	832400
3	514246	disc/red		677700
4	514247	disc/blue		675100

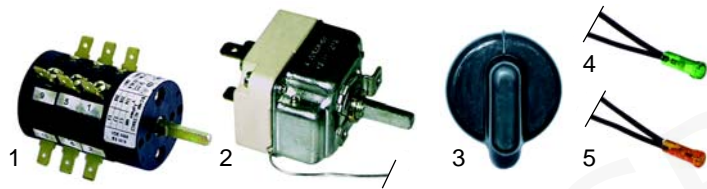

Item	Order	Description	Model	OEM
1	300084	selector switch		2464600
2	375201	thermostat	CON_G/GP	2992900
3	111500	knob	CON_E/EP	2795000
4	359004	signal lamp/green	CSM_G/EP	2998600
5	359005	signal lamp/yellow	CSM_E/EP	2998700

Components (electric)



Item	Order	Description	Model	OEM
1	345335	magnetic switch		51691.00
2	345336	magnet	CON_	51692.00
3	375206	safety thermostat	CSM_	28647.14

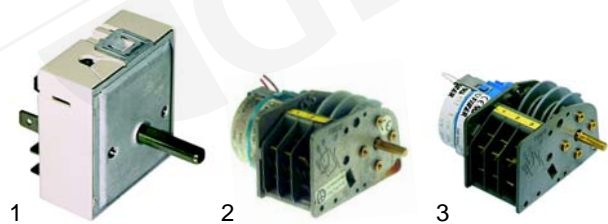

Item	Order	Description	Model	OEM
1	380015	energy regulator	CON_	426710
2	360331	timer		2971100
3	350033	timer	CSM_	5151600

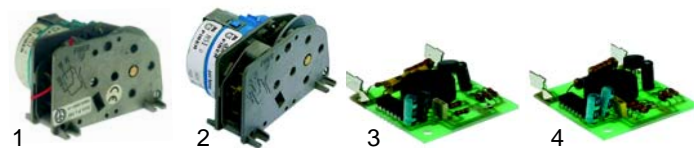

Item	Order	Description	Model	OEM
1	360332	timer	CON 6/10/102_	2971200
2	350034	timer	CON 201/202 CSN_	5151700
3	350078	buzzer		2864400
4	350079	buzzer	CON 201/202_ CSN_	5152000

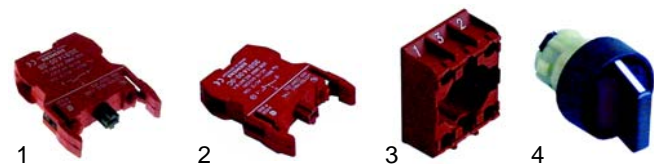

Item	Order	Description	Model	OEM
1	345525	contactor block NO		2959000
2	345562	contactor block NC	CON_	2959100
3	345482	holder	CSM_	2860700
4	345526	selector switch		2860600



Item	Order	Description	Model	OEM
1	401151	transformer	CON 6/10/102_	5159300
2	401152	transformer	CSM 6/10/102_	5153000
3	401153	transformer	_201/202_	5153100



Item	Order	Description	Model	OEM
1	346330	contactor block		2860900
2	345482	holder	CON_G/GP	2860700
3	346331	lamp	CSM_G/GP	2964800
4	346332	push button		2964900

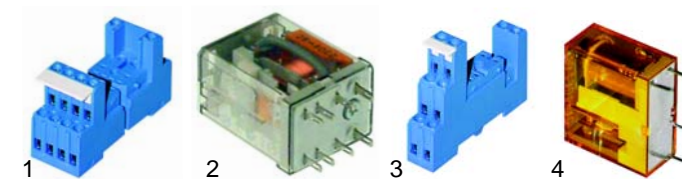

Item	Order	Description	Model	OEM
1	380341	base	CON 6/10/102	2998500
2	380382	relay		2998400
3	380340	base	CON 201/202	5151400
4	380331	relay	CSM_	5151300

Core temperature



Item	Order	Description	Model	OEM
1	379565	elctronic controller	universal	2959300
2	379137	sensor PT100	_6/10/102_	5158100
2	379138	sensor PT100	_201/202	5154600

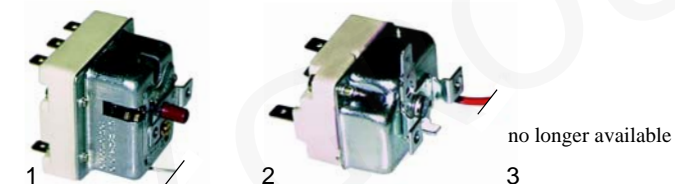

Item	Order	Description	Model	OEM
1	375208	safety thermostat, 132°C boiler		2865100
2	375207	thermostat 65°C fest	CSM_	5169800
3	n. l. a.	level regulator		2928500

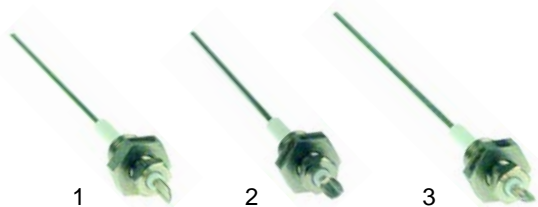

Item	Order	Description	Model	OEM
1	401154	electrode, 125mm	CSM 06 G/GP	2911600
2	401155	electrode, 132mm		2911700
3	401156	electrode, 150mm		2911800



Item	Order	Description	Model	OEM
1	401164	electrode, 144mm	CSM 10 E/EP	2899600
2	401156	electrode, 150mm		2911800
3	401165	electrode, 163mm		2899800



Item	Order	Description	Model	OEM
1	401157	electrode, 150mm	CSM 10 G/GP	2908300
2	401158	electrode, 158mm	CSM 102 E/EP	2908200
3	401159	electrode, 186mm	CSM 201 E/EP	2987000



Item	Order	Description	Model	OEM
1	401157	electrode, 150mm	CSM 201 E/EP CSM 202 E/EP	2908300
2	401158	electrode, 158mm		2908200
3	401160	electrode, 185mm		2908100

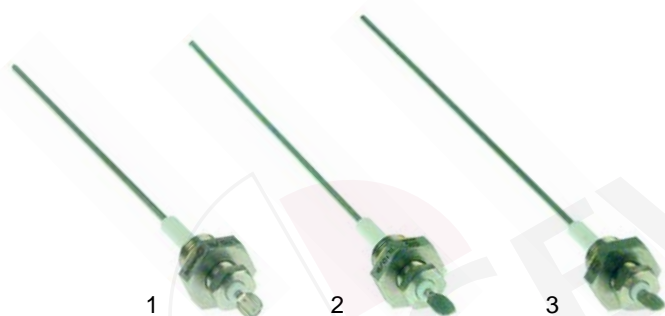

Item	Order	Description	Model	OEM
1	401160	electrode, 185mm	CSM 102 G/GP	2908100
2	401159	electrode, 186mm	CSM 201 G/GP	2987000
3	401161	electrode, 210mm	CSM 202 G/GP	2927500

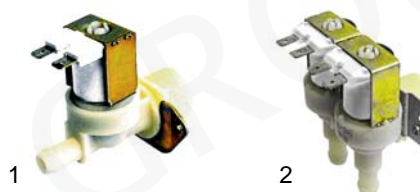

Item	Order	Description	Model	OEM
1	370017	solenoid valve, 230V	CON 6__ CON 10__ CON 102__	2709000
1	370029	solenoid valve, 24V	CON 201__ CON 202__ CSM__	2956900
2	370109	solenoid valve, 24V	CSM 201__ CSM 202__	5151500

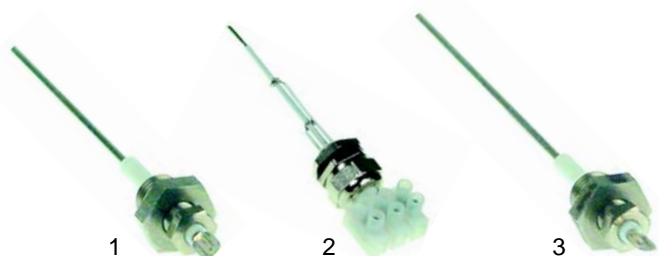

Item	Order	Description	Model	OEM
1	401162	electrode, 128mm	CSM 6 E/EP	2916100
2	401163	electrode, 135mm		2916200
3	401156	electrode, 150mm		2911800

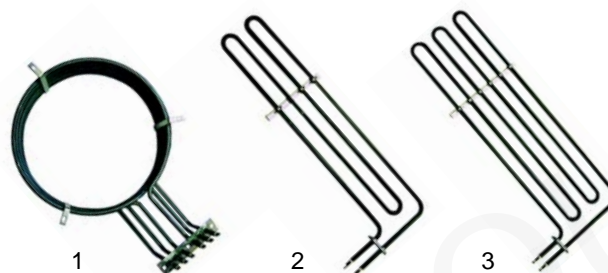

Item	Order	Description	Model	OEM
1	415997	9000W/400V	__6 E/EP	5152400
2	415998	3000W/400V	__10 E/EP __201 E/EP	5152100
3	415999	5000W/400V	__102 E/EP __202 E/EP	5152200



Item	Order	Description	Model	OEM
1	415957	9000W/400V	CSM_E/EP	5152300
2	510408	gasket		-



Item	Order	Description	Model	OEM
1	359713	bulb housing		
2	359612	bulb	universal	2861900
3	359714	gasket		2862100
4	359715	glass		2862100
5	359716	housing		2862100

Motors

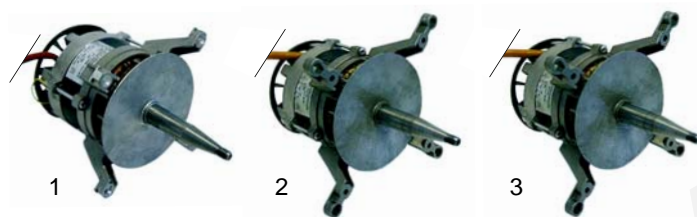

Item	Order	Description	Model	OEM
1	500130	motor, 230 V	CON_, CSM_ nur 6x1/1-Geräte	5186500
2	500131	motor, 230 V	(Außer 6x1/1) CON_G/GP CSM_G/GP	5163900
3	500132	motor, 400 V	(Außer 6x1/1) CON_E/EP CSM_E/EP	5183900

Fan wheels

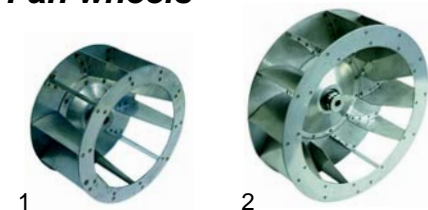

Item	Order	Description	Model	OEM
1	514036	Ø220mm	_6_	2861600
2	514037	Ø338mm	_10_	2919900



Item	Order	Description	Model	OEM
1	514038	Ø350mm	_102_ _201_	2939414
2	514039	Ø350mm	_202_	5103414
3	514040	shaft sealing	universal	2835600

Components (gas)



Item	Order	Description	Model	OEM
1	105730	burner hot air	6 G/GP	2862914
2	105731	burner hot air	10 G/GP	2862500
3	105732	burner hot air	102 G/GP 201 G/GP	2933500
4	105733	burner hot air	202 G/GP	5102300



Item	Order	Description	Model	OEM
1	105734	burner boiler	CSM 6G/GP	2862614
2	105735	burner boiler	CSM 10G/GP	5163800
3	105736	burner boiler	CSM 102G/GP CSM 201G/GP	2947600
4	105737	burner boiler	CSM 202G/GP	5102400

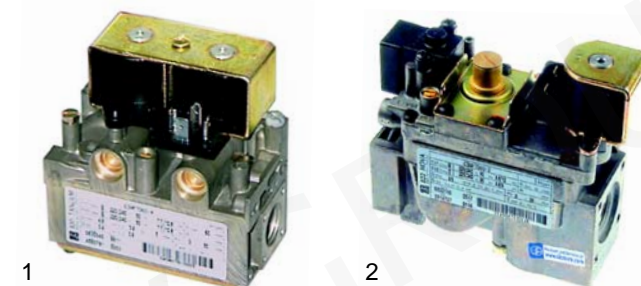

Item	Order	Description	Model	OEM
1	101189	tandem valve	_6G/GP _10G/GP	2942600
2	101967	Novasit gas valve	_102G/GP _201G/GP _202G/GP	5118500



Item	Order	Description	Model	OEM
1	541051	pressure switch	_G/GP	5151000
2	102324	ignition electrode		5149900
3	102325	monitoring electrode		5126900

Components (mechanical)



Item	Order	Description	Model	OEM
1	700060	door handle	_6_	2872000
2	700061	door catch	_10_ _102_	5129900

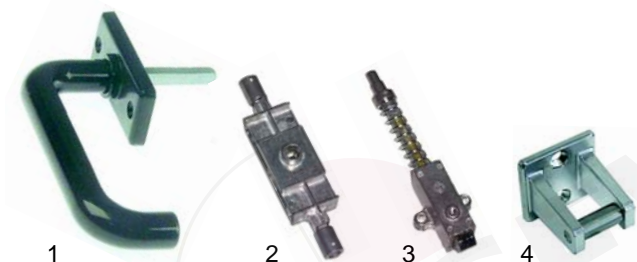

Item	Order	Description	Model	OEM
1	690399	handle		5156100
2	690042	gearbox	_201_ _202_	5154800
3	690041	ratchet		5145100
4	690040	door catch		5156000

Door seals

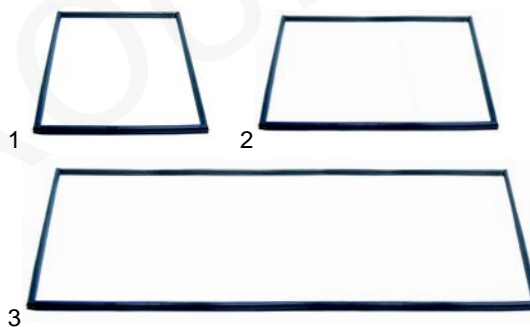

Item	Order	Description	Model	OEM
1	900106	645x490mm	_6_	2885900
2	900107	645x740mm	_10_ _102_	2891900
3	900108	720x1460mm	_201_ _202_	5113500

Window seals

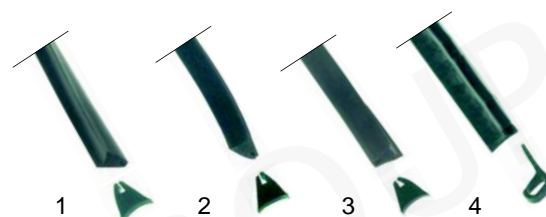

Item	Order	Description	Model	OEM
1	900435	2350mm	_6_	2885800
2	900436	2170mm	_10_, _102_	2891700
3	900437	10m	_201_, _202_	2838000
4	900438	double-glazing gasket		5109600

Suitable for Mareno

Stockpot stoves (gas)



Item	Order	Description	Model	OEM
1	105276	burner cover		1205900
2	105277	burner	FP165	1104300
3	105278	gasket		1104600 1104612

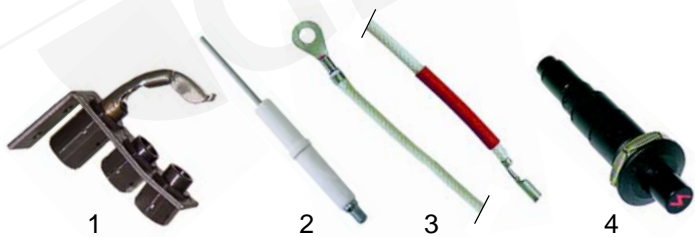

Item	Order	Description	Model	OEM
1	100095	pilot burner		1887700
2	100701	electrode	FP165	1888300
3	100186	ignition cable		1936300
4	100009	piezoelectric igniter		1936100



Item	Order	Description	Model	OEM
1	102042	thermocouple, 850mm		1916000
2	101086	gas tap PEL22	FP165	1884100
3	110364	knob		1840900
4	110601	symbol		184200, 862300

Stockpot stoves (electrical)

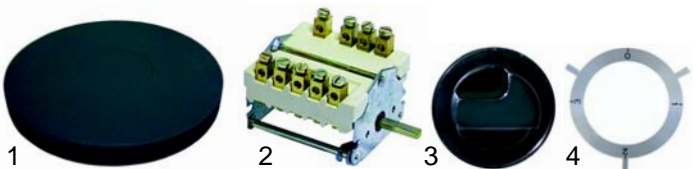

Item	Order	Description	Model	OEM
1	490106	5000W/400V		779111
2	300104	switch	FP1E	790700
3	110360	knob		18407000
4	110605	symbol		1039111200

Table top cookers (gas)



Item	Order	Description	Model	OEM
1	103020	burner cover, 80mm		1315612
2	104030	burner base		1315422
3	104033	Venturi	FB-1GS/new, FB-2GS/new	1315212
4	105051	aeration sleeve		1314700
5	105052	jet rod		1306615



Item	Order	Description	Model	OEM
1	103021	burner cover, 100mm		1315712
2	104031	burner base		1315512
3	103150	Venturi	FB-1GS/new, FB-2GS/new	1892500
4	105051	aeration sleeve		1314700
5	105052	jet rod		1306615
6	103151	intermediate ring		1893300

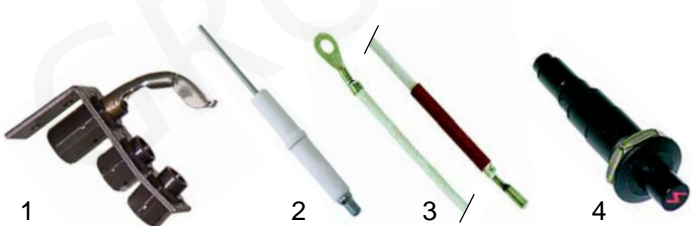

Item	Order	Description	Model	OEM
1	100095	pilot burner		1887700
2	100701	electrode	FB-1GS/new, FB-2GS/new	1888300
3	100195	ignition cable, 1200mm		1950324
4	100009	piezoelectric igniter		1906100



Item	Order	Description	Model	OEM
1	102042	thermocouple		1916000
2	101397	gas tap PEL21	FB-1GS/new, FB-2GS/new	1888700, 1888800
3	110363	knob		1840800
4	110601	symbol		1842000, 862300



Item	Order	Description	Model	OEM
1	103020	burner cover, 80mm		1315600
2	104030	burner base		1315400
3	104033	Venturi	FB1GS (old), FB2GS (old)	1315200
4	105051	aeration sleeve		1314700
5	105052	jet rod		1306600



Item	Order	Description	Model	OEM
1	103021	burner cover, 100mm		1315700
2	104031	burner base		1315512
3	104034	Venturi	FB1GS (old), FB2GS (old)	1315300
4	105051	aeration sleeve		1314700
5	105052	jet rod		1306600



Item	Order	Description	Model	OEM
1	100838	ignition line		1314600
2	100890	holder	FB1GS (old), FB2GS (old)	1314915
3	100883	pilot burner		1314800
4	100885	aeration sleeve		1324900



Item	Order	Description	Model	OEM
1	102054	thermocouple, 320mm		641400
2	102067	nut, M8x1		939300
3	101095	gas tap, PEL21S		1700200
4	110363	knob	FB1GS (old), FB2GS (old)	1840800
5	110601	symbol		1842000, 862300

Toasters



Item	Order	Description	Model	OEM
1	416572	1000W/230V		1037316500
2	359036	signal lamp		1037300810
3	380015	energy regulator	TSE-60M	426700, 1037035310
4	110408	knob		1036702200

Salamander

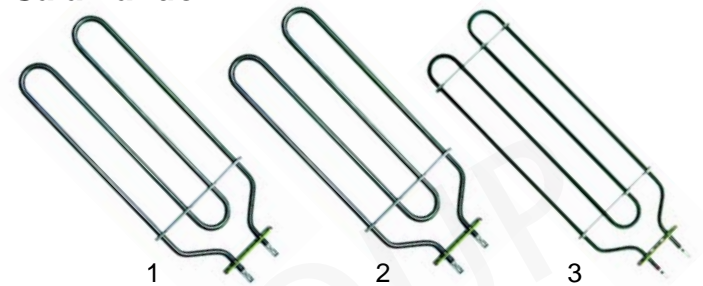

Item	Order	Description	Model	OEM
1	415140	2000W/230V	SME62M	1037316100 1037041200
2	415141	3000W/230V	SME63M	1037316200 1037042200
3	415142	3500W/230V	SME70M	1037316300 1037042300

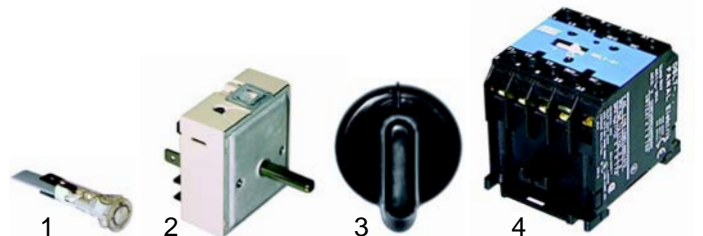

Item	Order	Description	Model	OEM
1	359036	signal lamp		1037300810
2	380015	energy regulator	SME62M SME63M SME70M	426700 1037035310
3	110408	knob		1036702200
4	380213	contactor, 20A	SME70M	21453199

M Rebaking ovens for pizza

Suitable for Mareno

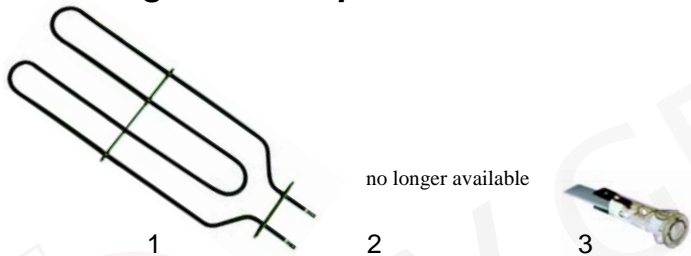

Item	Order	Description	Model	OEM
1	416573	1000 W/230 V	SPE60M	1037316400
2	n. l. a.	1000 W/230 V	SPW60M	1037340713
3	359036	signal lamp	SPE60M, SPN60M	1037300810



Item	Order	Description	Model	OEM
1	375322	thermostat, 1-pole	SPE60M	1037103500
2	350049	timer	SPW60M	1037103400
3	110408	knob		1036702200

Radiant heaters

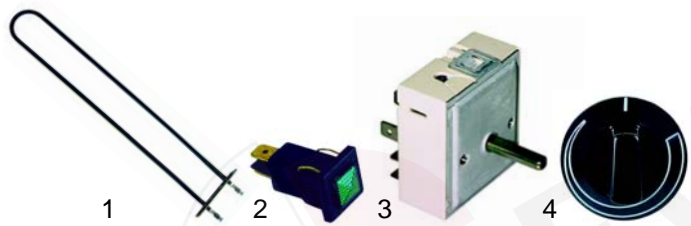

Item	Order	Description	Model	OEM
1	416665	1000 W/230 V		1037041613 1037041600
2	359270	signal lamp	RIE-40M, RIEP-40M	1037036300
3	380015	energy regulator		426710
4	110895	knob		1031019000

Hot cupboards

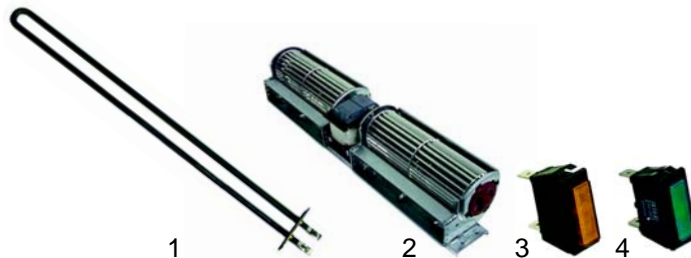

Item	Order	Description	Model	OEM
1	416575	770 W/230 V		1215400
2	601037	fan with transverse flow	TP-13E/17E/21E,	1215500
3	359159	signal lamp/yellow	TP2-13E/17E/21E	912800
4	359160	signal lamp/green		1230300

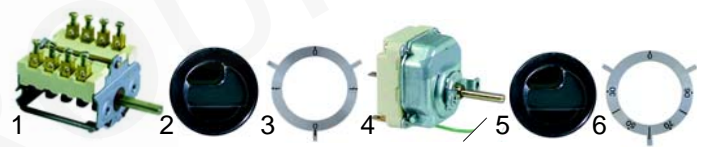

Item	Order	Description	Model	OEM
1	300021	switch		1230100
2	110360	knob		1840700
3	110604	symbol	TP-13E/17E/21E,	1229000
4	375411	thermostat	TP2-13E/17E/21E	1230200
5	110360	knob		1840700
6	110610	symbol		1218500

Fryers



Item	Order	Description	Model	OEM
1	416576	2500 W/230 V	FQE4	1037305600
2	416577	3500 W/230 V	FQE6/6+6	1037305700
3	375323	safety thermostat		1031028000
4	359036	signal lamp/clear	FQE4, FQE6, FQE6+6	1037300810
5	359140	signal lamp/yellow		1037300910

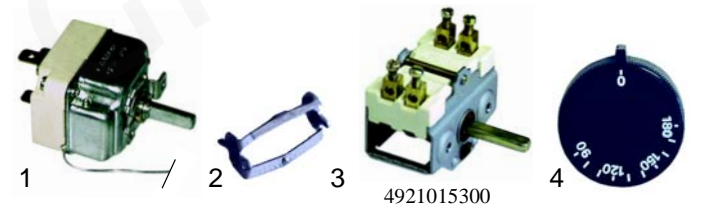

Item	Order	Description	Model	OEM
1	390046	thermostat		1037035800
2	550060	retainer	FQE4, FQE6, FQE6+6	921200
3	300091	switch		1037035700
4	110896	knob		1031019800



Item	Order	Description	Model	OEM
1	970334	basket	FQE4	1031108200
2	970335	basket	FQE6, FQE6+6	1031108700
3	540698	drain tap		1031401900

