



REFERENCE BOOK



PROIZVODNI PROGRAM

1. Zaptivači za pločaste izmenjivače toplote,
2. Zaptivači za leptiraste ventile i cevne spojeve,
3. Elementi opreme za preradu i pakovanje tečnosti,
4. Zaptivači hidrauličkih i pneumatskih sklopova,
5. Vakuum hvatači opreme za pakovanje i paletiziranje,
6. Membrane-dijafragme membranskih ventila i pumpi,
7. Radna kola, obloge, ležajevi i mehanički zaptivači pumpi,
8. Elementi elastičnih spojeva elektro motora i reduktora,
9. Elastični oslonci, odbojnici, kompenzatori, amortizeri i sylan blokovi,
10. Gumirani valjci transportnih uređaja i sistema,
11. Gumeni i gumeno metalni točkovi,
12. Svi ostali proizvodi prema tehničkoj dokumentaciji ili uzorku,

OBLAST PRIMENE:

- Hemijska industrija , Prehrambena industrija , Mašinska industrija, Rudarstvo , Građevinarstvo , Metalurgija , Energetika...

PROGRAM OF PRODUCTION

1. Rubber gaskets for plate heat exchanges,
2. Sealant parts for pipe fittings,
3. Spare parts for bottling equipment,
4. Cuffs for hydraulics and pneumatics,
5. Vacuum holders for packing equipment,
6. Diaphragms for membrane valves and pumps,
7. Rubber coated impellers, bearings and mechanical pump gaskets,
8. Rubber parts of elastic couplings,
9. Elastic pads, buffers, absorbers and sylan blocks,
10. Rubber coated rolls,
11. Rubber and rubber-steel wheels,
12. Other products according to technical documentation or sample.

APPLICATION :

- Chemical industry, food processing, machine-tool industry, pharmaceutical industry, mining and civil engineering, metallurgy, energetics

HEMIJSKA I TEMPERATURNI POSTOJANOST MATERIJALA

	NR	SBR	NBR	CR	IIR	EPDM	VMQ	EU	FKM
VODA	1	1	1	1	1	1	1	1	1
PRIRODNI GAS	4	4	1	2	4	2	4	4	1
MINERALNE KISELINE	3	3	3	2	2	2	4	4	1
LUŽINE	1	1	4	1	1	1	4	4	4
ORGANSKE KISELINE	4	4	3	4	2	2	3	4	4
NAFTINI DERIVATI	4	4	1	2	4	4	2	2	1
BILJNA ULJA	4	4	1	2	3	2	1	1	1
VODENA PARA	4	3	4	2	1	1	4	4	1
OZON	4	3	3	2	2	1	1	1	1

TEMPERATURNI OPSEG (°C)

-50÷100 -30÷100 -30÷100 -30÷100 -40÷140 -40÷150 -60÷250 -30÷80 -20÷250

LEGENDA:

- NR** Prirodni kaučuk,
- SBR** Stiren-butadien kaučuk
- NBR** Butadien-nitrilni kaučuk
- CR** Polihloropren
- IIR** Butil kaučuk
- EPDM** Etilen-propilen ter polimer
- VMQ** Silikon
- EU** Poliuretan
- FKM** Fluor kaučuk

Ocena postojanosti:

- 1- Postojan u potpunosti
- 2- Postojan,
- 3- Delimično postojan,
- 4- Nepostojan.

ZAPTIVAČI ZA PLOČASTE IZMENJIVAČE TOPLOTE

Oblast primene:

Uređaji za termičku obradu različitih vrsta fluida u energetici , hemiskoj , prehambrenoj , farmaceutskoj industriji... hladionici , grejači , pasterizatori , sterilizatori , evaporatori ...

<u>PROIZVOĐAČ IZMENJIVAČA</u>	<u>TIP IZMENJIVAČA</u>
<u>TETRA-LAVAL</u>	A-10 , A-15 , AM-10 , AM-20 , H-7 , H-10 , P-0 , P-2 , P-5 , P-13 , P-14 , P-15 , P-17 , P-25 , P-31 , P-45 , M-6 , M-10 , M-15 , M-20 , CLIP 6 , CLIP 8
<u>FISCHER</u>	EUROCAL 7 , EUROCAL 18 , EUROCAL 28 , EUROCAL 30 , EUROCAL 32 , EUROCAL 40 , EUROCAL 50 , EUROCAL 50A , EUROCAL 51 , EUROCAL 61
<u>SCHMIDT</u>	SIGMA 12 , SIGMA 16 , SIGMA 17 , SIGMA 18 , SIGMA 19 , SIGMA 22 , SIGMA 27 , SIGMA 32 , SIGMA 37 , EVAPORATORI SIGMA 55 i SIGMA 80
<u>GEA-AHLBORN</u>	VT-04 , VT-10 , VT-20 , VT-40 , VT-80
<u>PASILAC</u>	PBA-1 , PBA-2 , PBA-3 , 1020 , 1050 , 1070
<u>APV</u>	PR-017 , HX-25 , HMB , N-35 , R-50 , R-52 , EVAPORATOR P-E
<u>JEDINSTVO</u>	PBA-2 , P-1 , VKL

MATERIJALI: NBR, EPDM , FKM

Vršimo remont pločastih izmenjivača toplote (demontaža uređaja , čišćenje ploča , ispitivanje ploča penetrantima , ugradnja zaptivača , montaža uređaja , puštanje u rad i izrada dokumentacije).



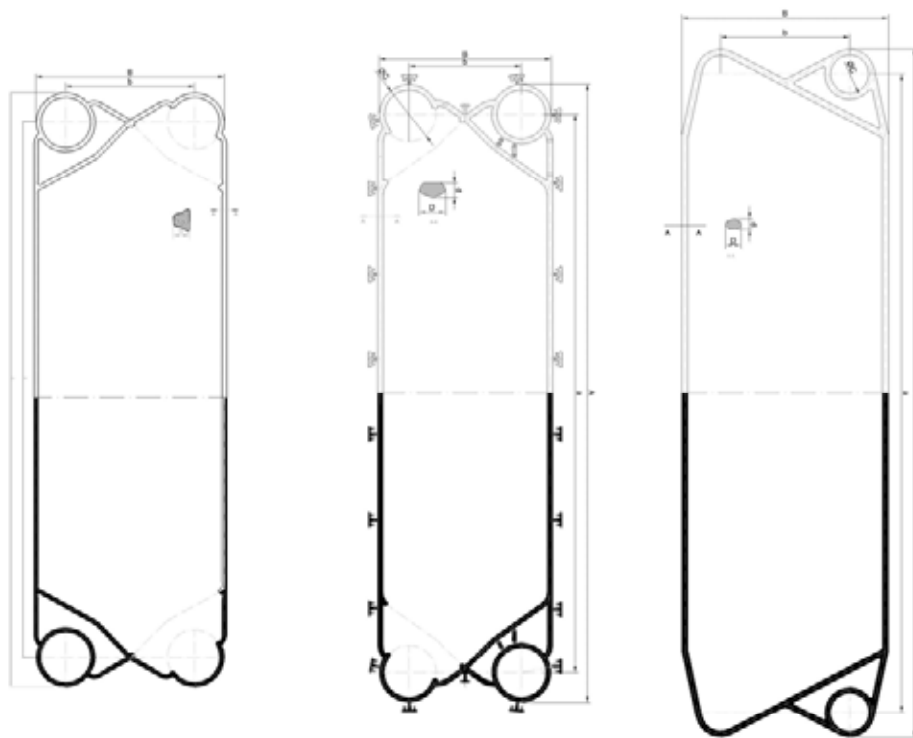
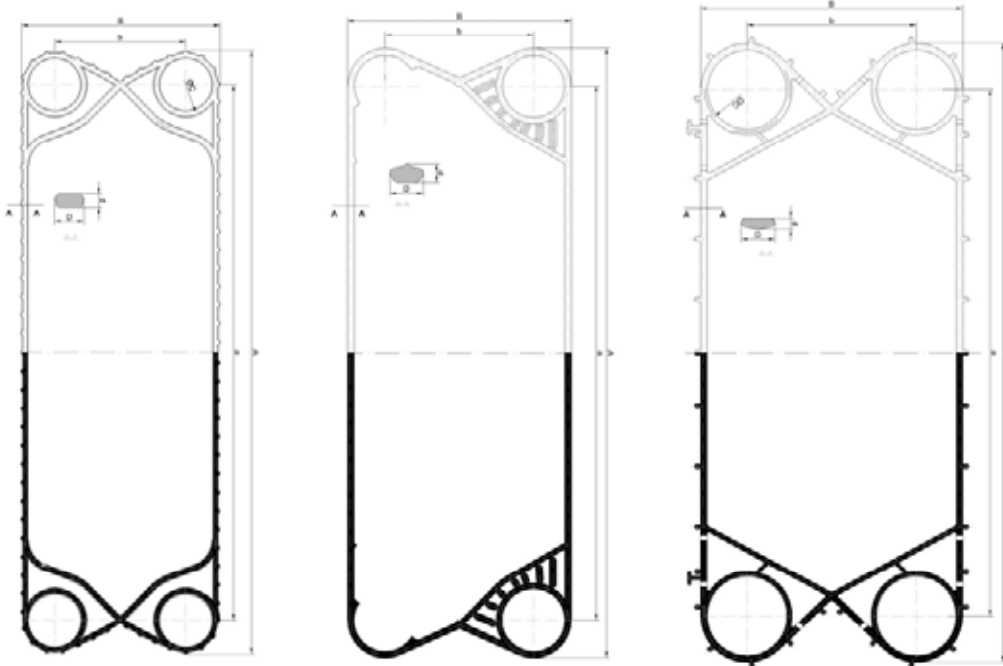

ZAPTIVAČI ZA LEPTIRASTE VENTILE I CEVNE SPOJEVE

MATERIJALI: NBR, EPDM ,VMQ , FKM



GUMENI ULOŠCI ZA LEPTIR VENTILE

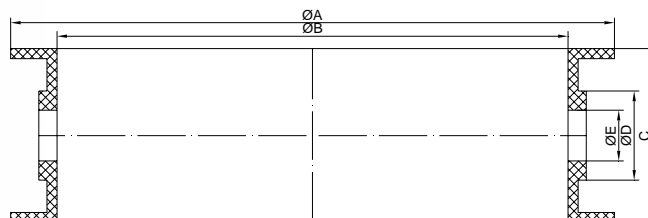
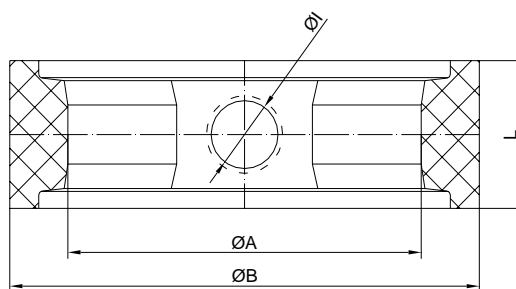
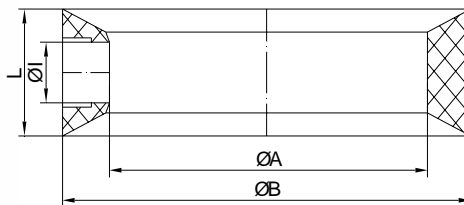

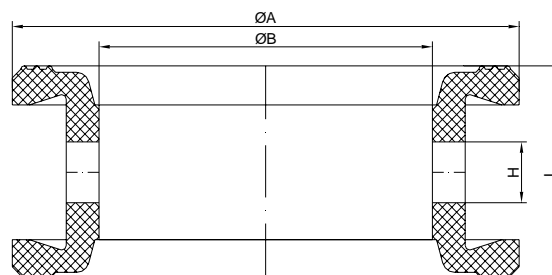
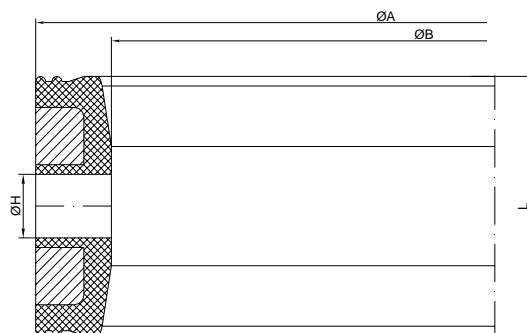
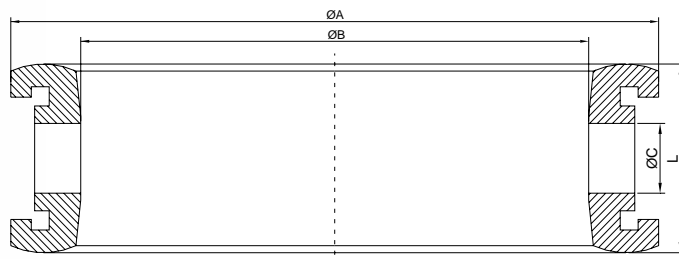

ELEMENTI OPREME ZA PRERADU I PAKOVANJE TEČNOSTI

Oblast primene:

Linije za otakanje , zatvaranje , etikitiranje , pakovanje i paletiziranje mineralnih voda , sokova , mleka , piva , ulja , vina i alkohola.

Materijali:

...NBR , EPDM , VMQ , FKM , PU, PTFE...

Plastika : PE , PP , PA6 , PA6.6 , POM...

Čelici i legure lakih metala, grafit...



A-ZAPTIVKA

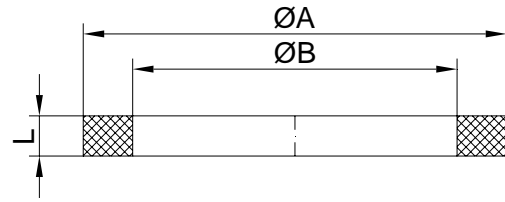

D-RING

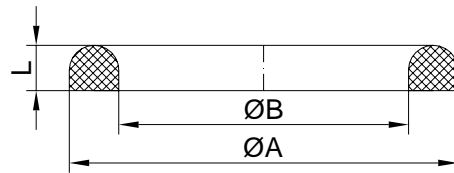

Q-RING

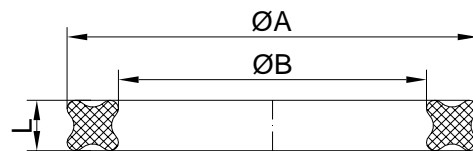

O-RING

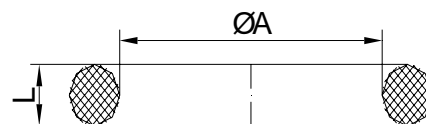

V-RING

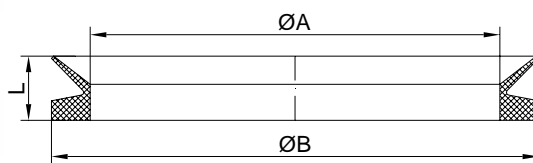

KONUSNE GUMICE

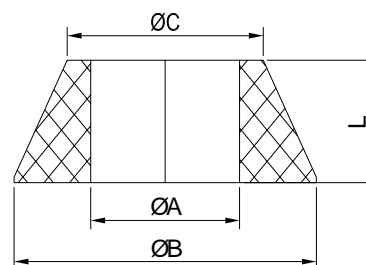
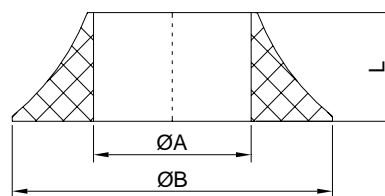
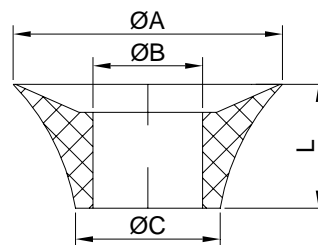

KONUSNE GUMICE

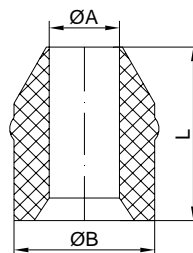

ZAPTIVKA ZA GAS

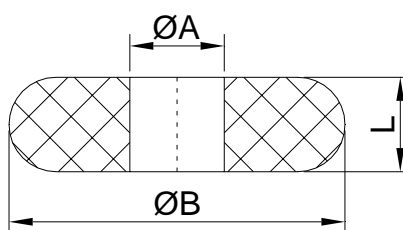

ULIVNICI (AMPRESI)

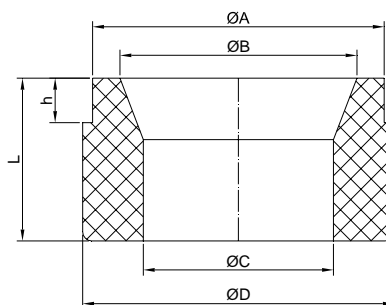
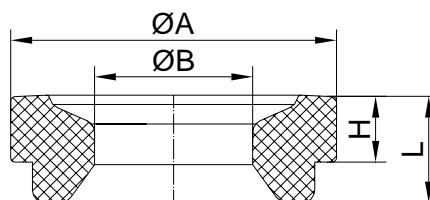

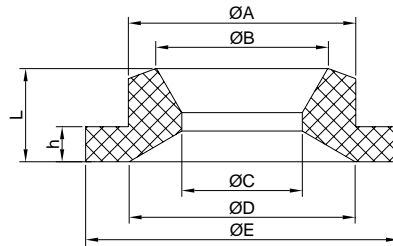
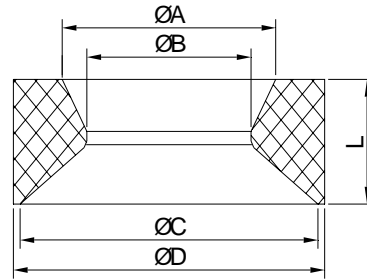
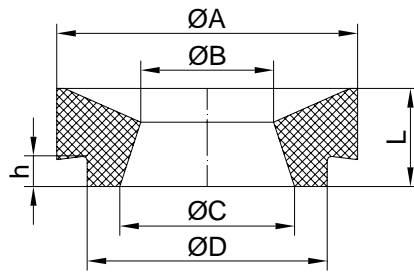

MANŽEZA CNTRALNOG STUBA

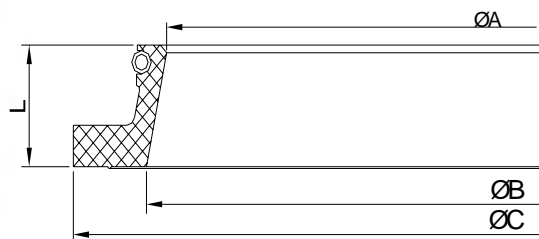

PODMETAČI

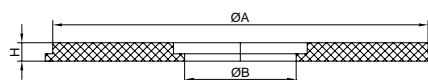
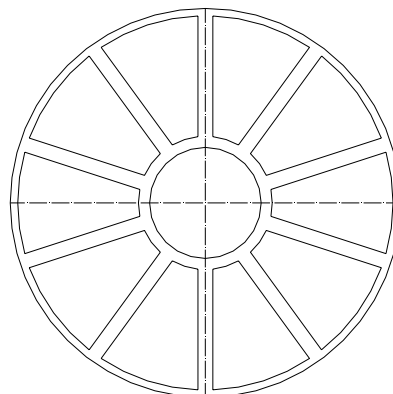
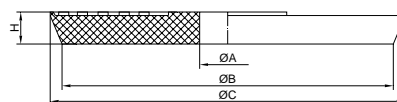
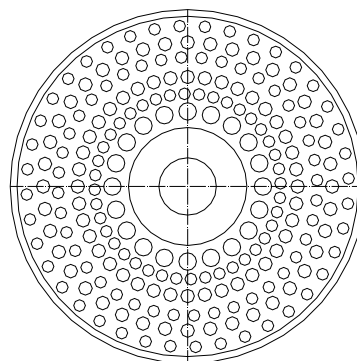
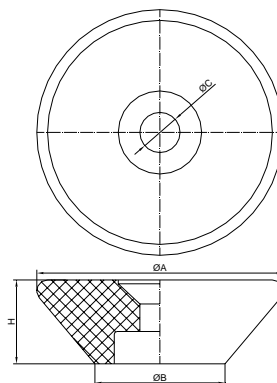

DRŽAČ FLAŠA

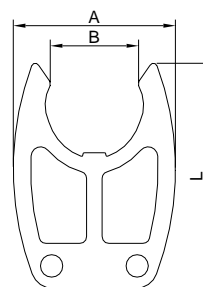

MEMBRANE UPAKIVAČA-ISPAKIVAČA

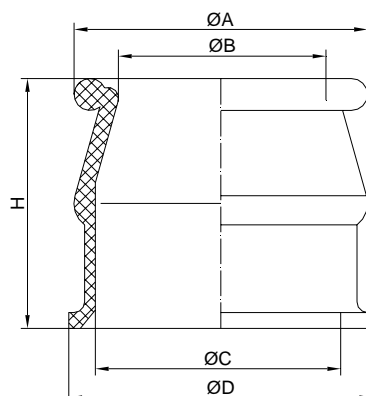
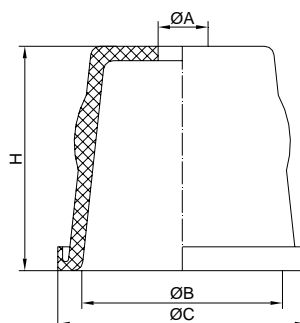
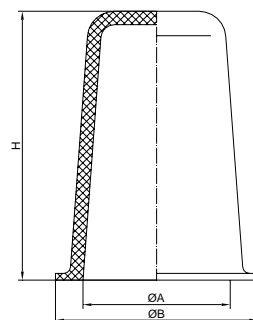

ZAPTIVAČI HIDRAULIČKIH I PNEUMATSKIH SKLOPOVA

Oblast primene:

Zaptivanje svih vrsta pokretnih i nepokretnih sklopova "O"-prstenovima, manžetama , semerinzima , "Q"-ringovima , "V"-ringovima...

Materijali:

NR , NBR , FKM , PU ...

Plastika: PE , PP , PAG , PA6.6 , POM , PTFE ...

Čelici i legure lakih metala.



A-ZAPTIVKA

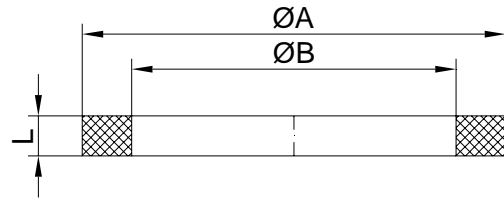

Q-RING

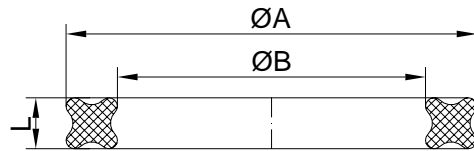

O-RING

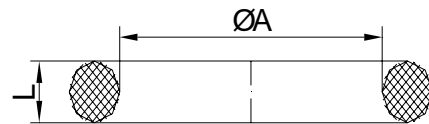

V-RING

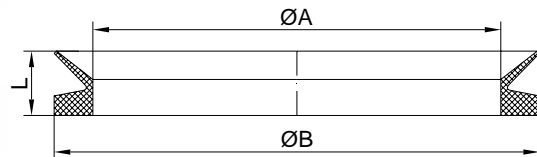

MANŽETE

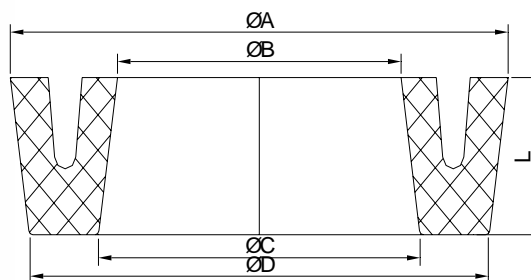
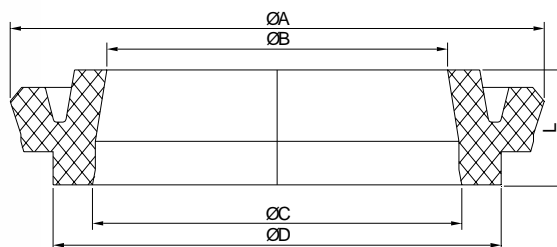
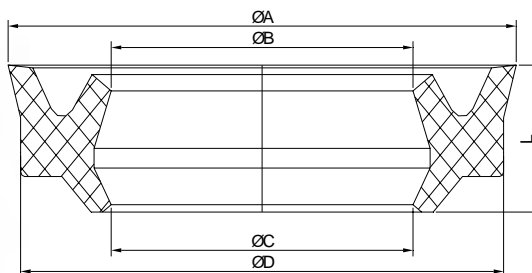

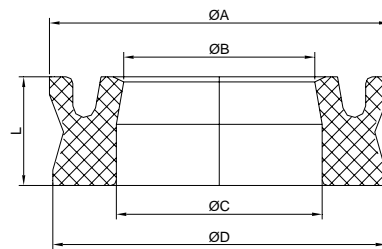
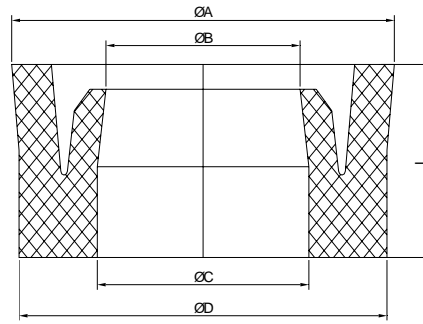

DVOSTRANA MANŽETA

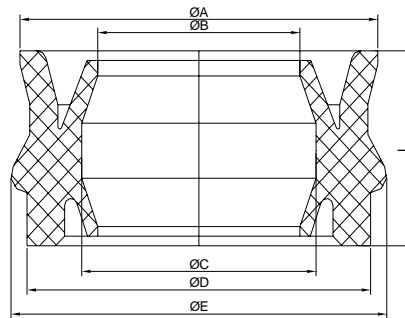

SET MANŽETI

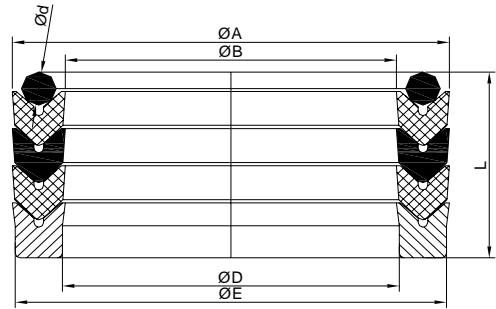

TOP MANŽETE

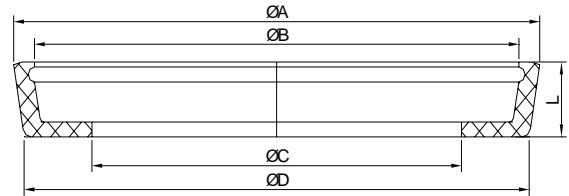

``S`` MANŽETA

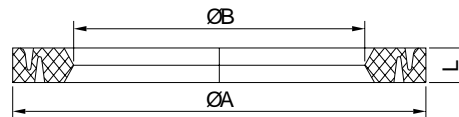

MANŽETA SA PLASTIČNIM PRSTENOM

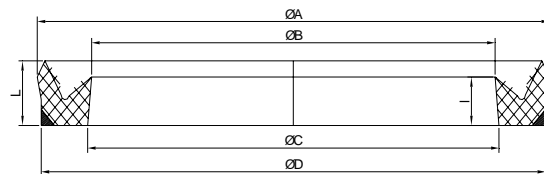

MANŽETA SA METALNIM KLIPOM

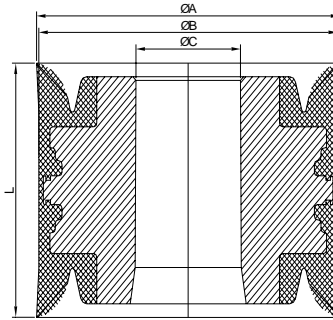

SEMERING

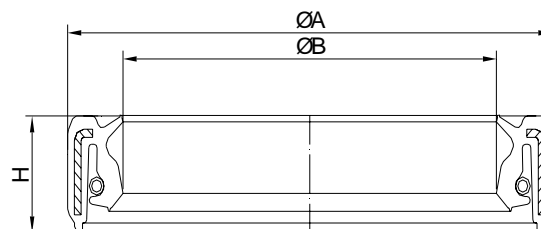
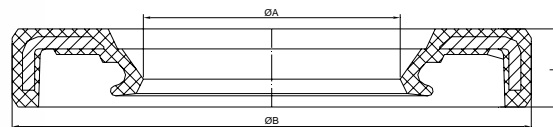
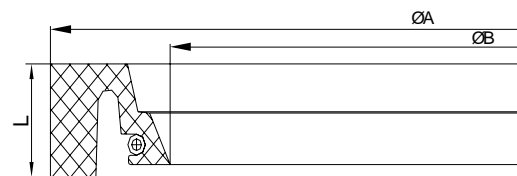

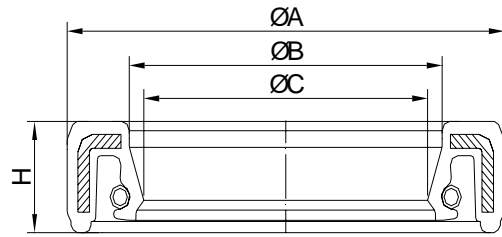

SEMERING AL-VITON

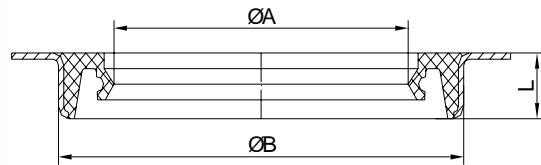
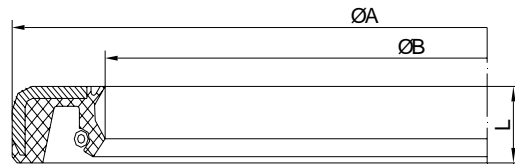

VAKUUM HVATAČI OPREME ZA PAKOVANJE I PALETIZIRANJE

Oblast primene:

Oprema za pakovanje različitih proizvoda u papirnoj, kartonskoj , PVC i drugoj ambalaži.

Materijali:

NR , VMQ



VAKUUM HVATAČI

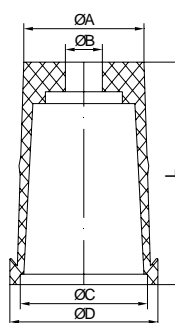
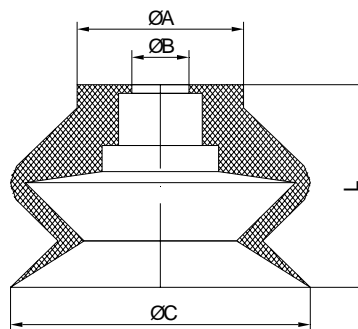
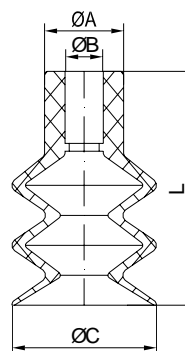

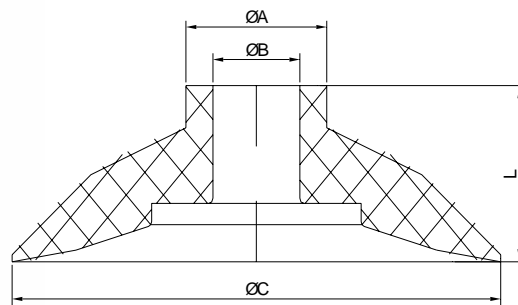
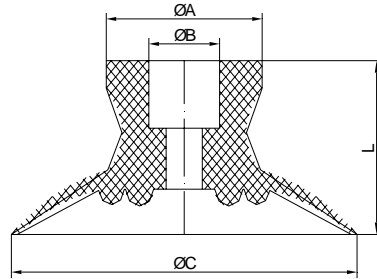
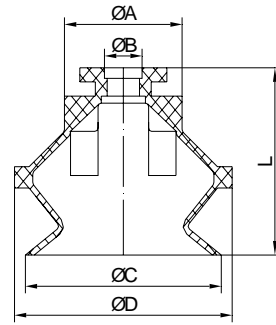

MEMBRANE-DIJAFRAGME MEMBRANSKIH VENTILA I PUMPI

Materijali:

NR , NBR , CR , EPDM , VMQ , FKM , PTFE ...

Guma armirana pamučnim , poliesterskim i poliamidnim platnom .

Gumena armirana presvu;ena slojem teflona



MEMBRANE

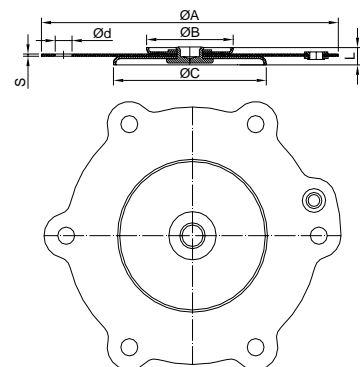
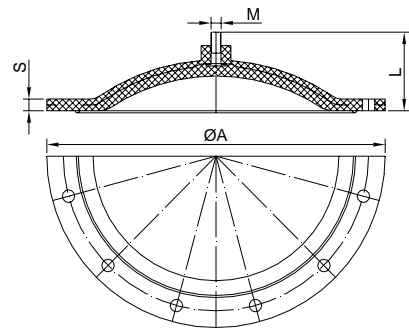
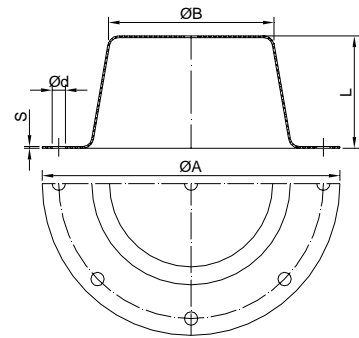
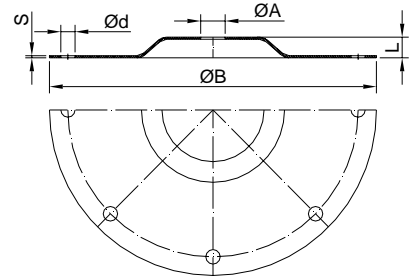

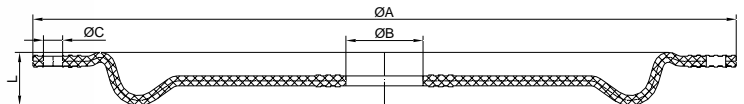
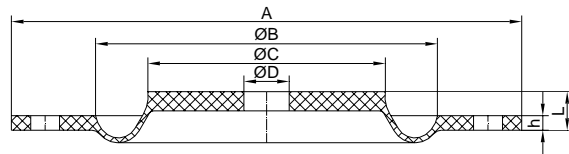
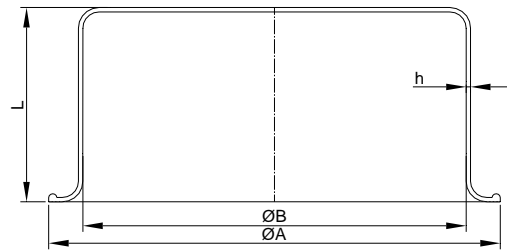
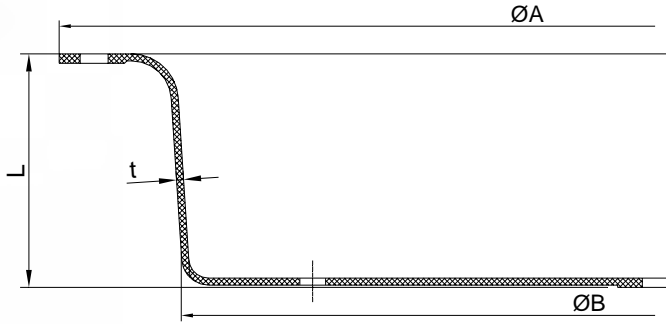

GUMENO-TEFLONSKA MEMBRANA

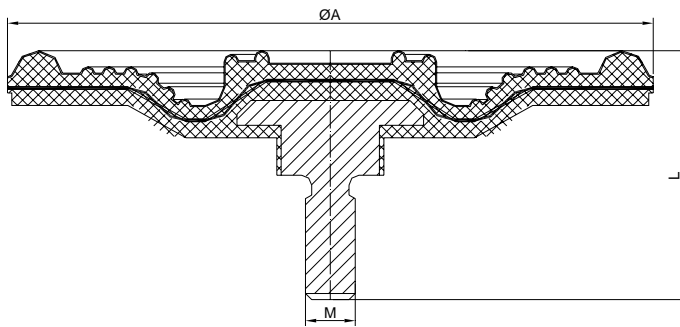
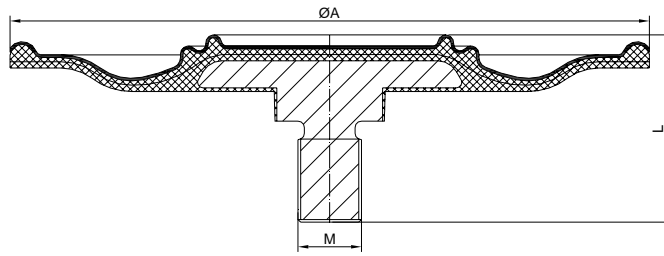

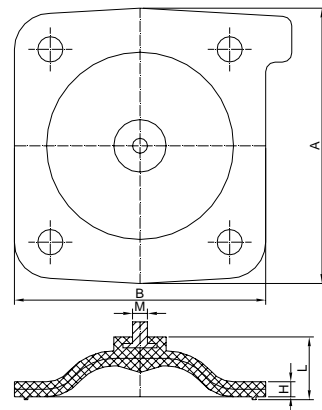
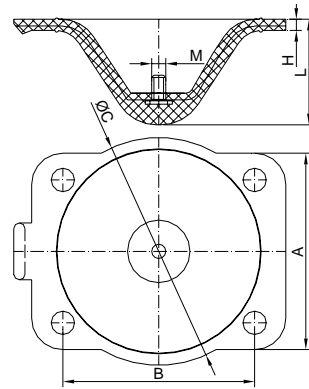
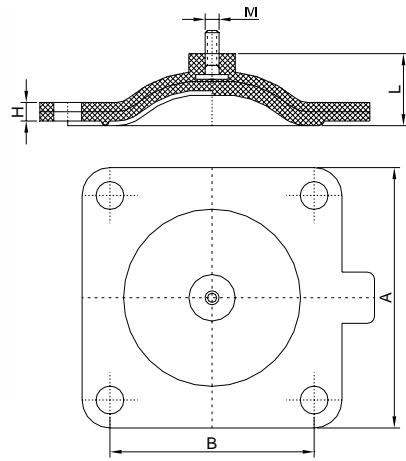

RADNA KOLA , OBLOGE , LEŽAJEVI I MEHANIČKI ZAPTIVAČI PUMPI

Oblast primene:

Transport abrazivnih i agresivnih vodenih i drugih suspenzija ,
transport visoko-viskoznih fluida (vijčane ekscentrične pumpe-mono
pumpe)

Materijali:

NR , NBR , CR , EPDM , FKM , PU...

Grafit , keramika...

Čelici i legure lakih materijala



RADNA KOLA-ROTORI

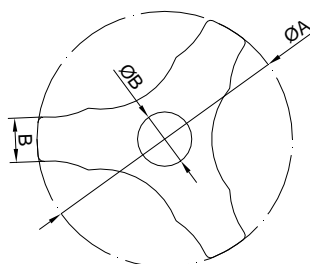
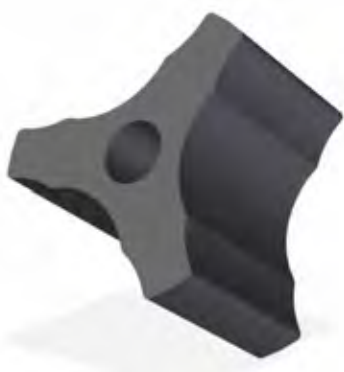
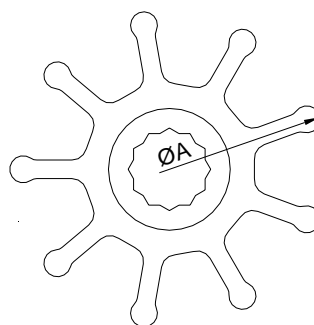
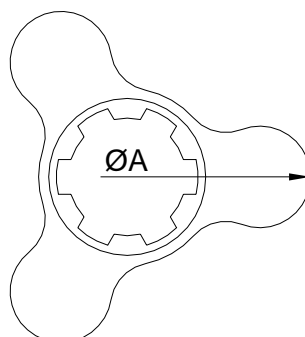
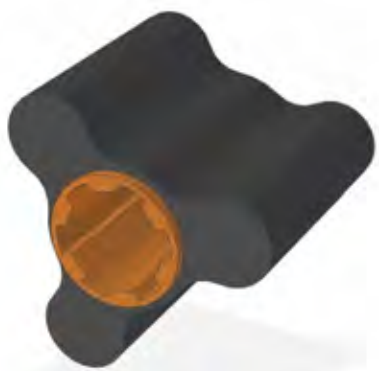
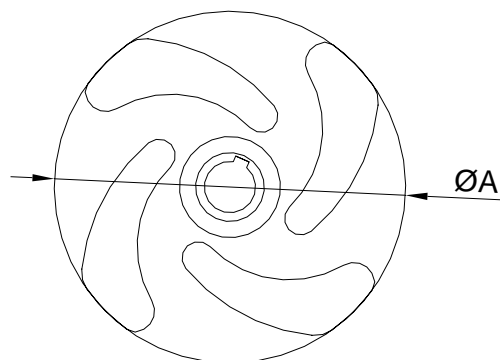

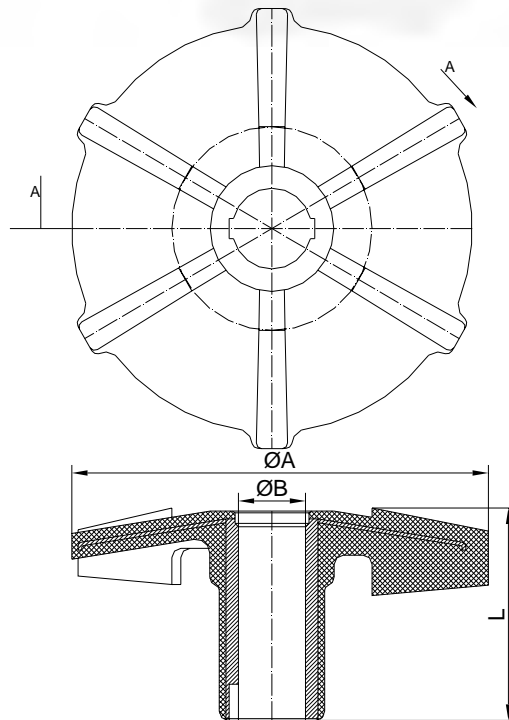
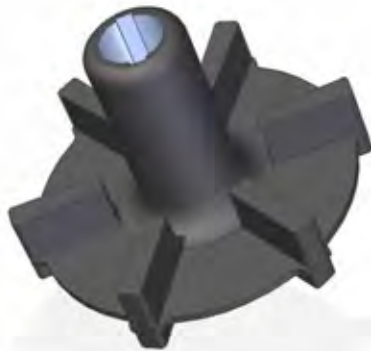
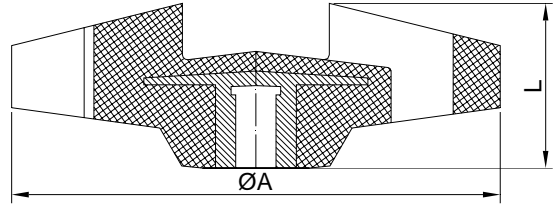

OBLOGA ZA RADNO KOLO



GUMIRANI LEŽAJ

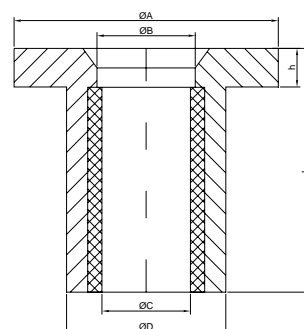
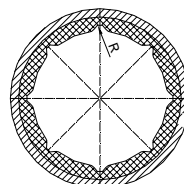
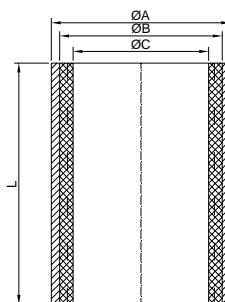

ROTOR , STATOR PUMPE

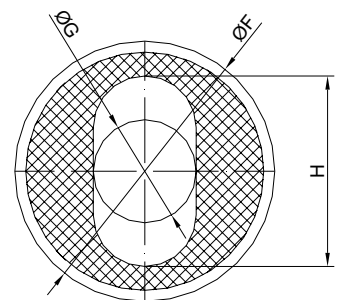
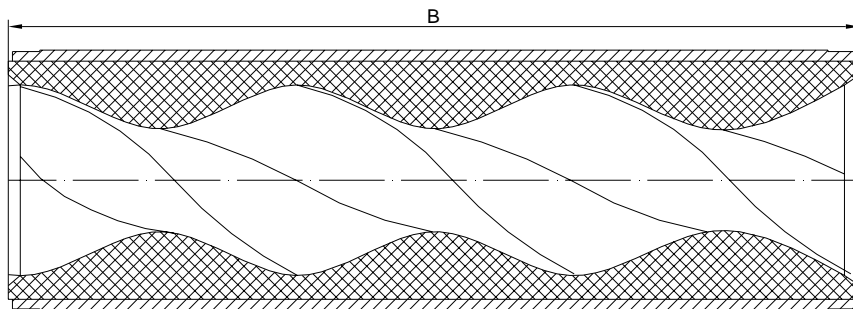
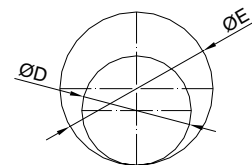
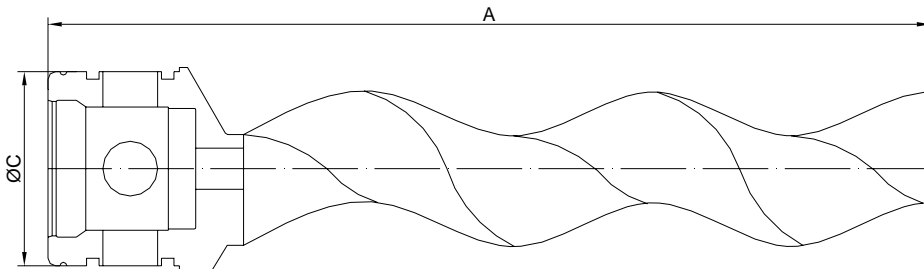
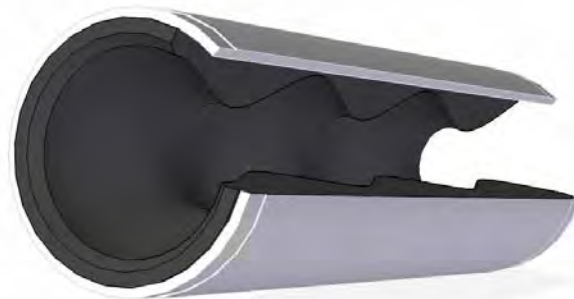

ARMIRANO CREVO

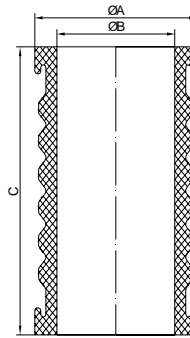

PRAHOBRAN

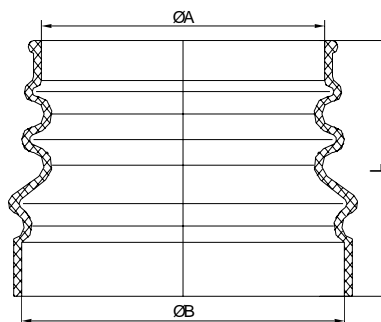
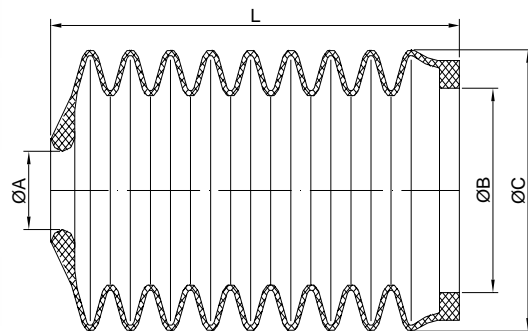
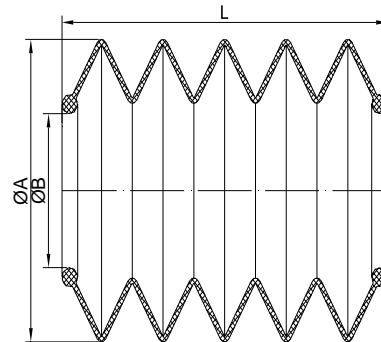

SINK ZAPTIVKA

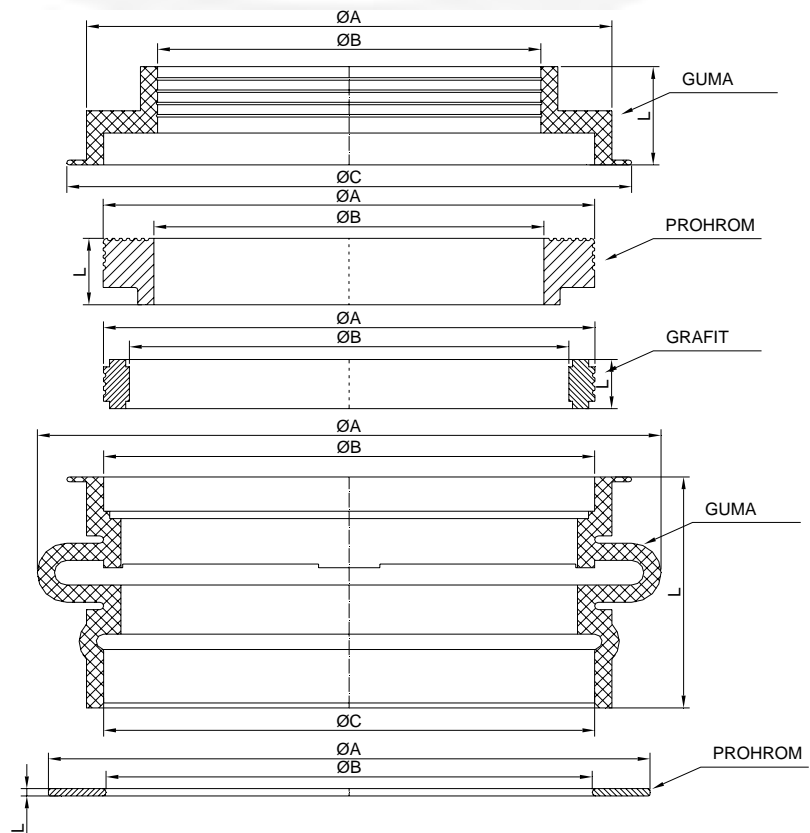

ELEMENTI ELASTIČNIH SPOJEVA ELEKTROMOTORA I REDUKTORA

Oblast primene:

Svi oblici umetaka elastičnih spojnic : "H" , klinasti , buričasti , rebrasti , zvezdasti , kandžasti...

Periflex obodne gume rasečene , šeširaste ...

Materijali:

NR , NBR , PU...

Pamučna , poliesterska i poliamidna platna...

Čelični , plastični i umetci od legura lakih metala...



SPOJNICE

“PERIFLEX”

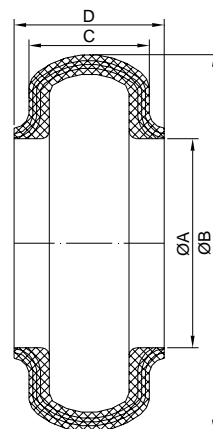

OZNAKA SPOJNICE	06-1	06-3	10-1	10-3	14-1	18-1	22-1	25-1	26-1	28-1
OZNAKA OBRUČA	10-112	10-162	10-212	10-262	10-312	10-361	10-412	10-462	10-512	10-562

“ŠEŠIRASTI PERIFLEX”

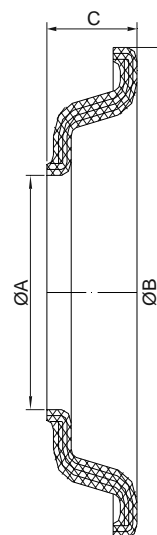

CILINDRIČNI UMETAK SPOJNICE

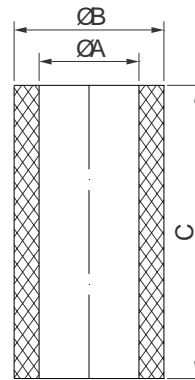

REBRASTI UMETAK SPOJNICE

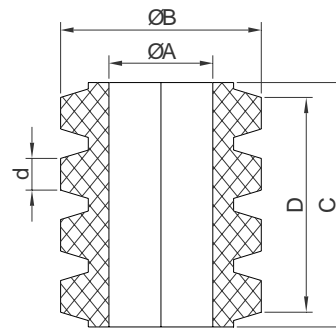

BURIČASTI UMETAK SPOJNICE

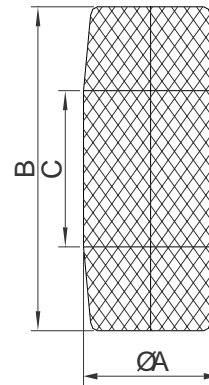

BURIČASTI UMETAK SPOJNICE

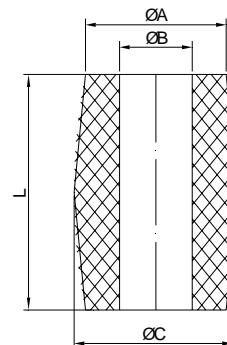

KANĐASTI UMETAK SPOJNICE

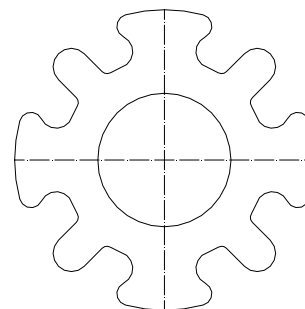
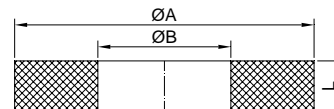
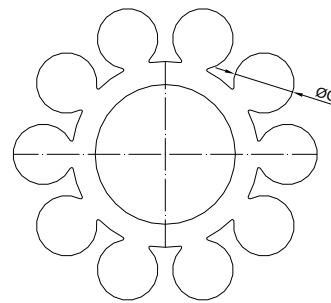
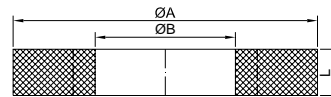
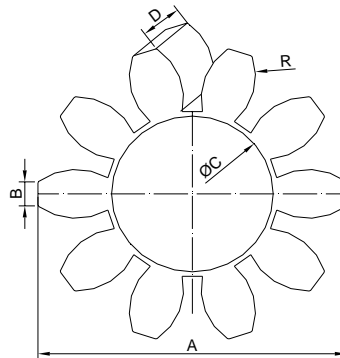

SEGMENT UMETKA SPOJNICE

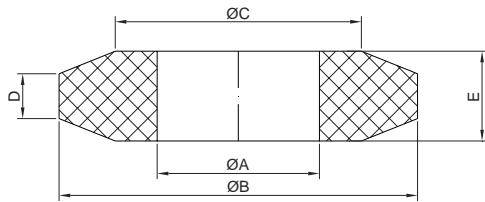

H-SPOJNICA

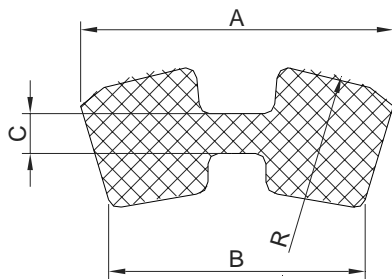

GUMENO-METALNA SPOJNICA

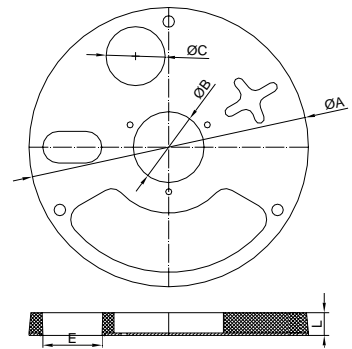
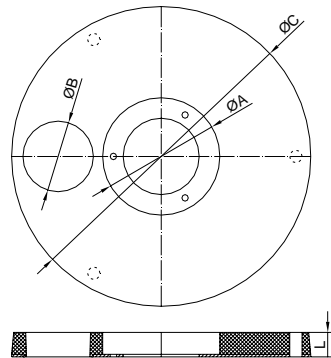

METALASTIK

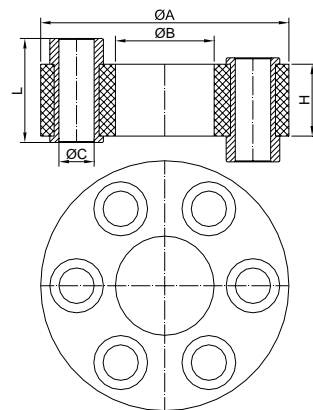

ELASTIČNI OSLONCI I APSORBERI VIBRACIJA

Oblast primene:

Apsoepcija vibracija visoko-frekventnih mašina i motora, gumeni i gumeno-metalni elastični odbojnici svih oblika i namena, kompezatori cevnih armatura i elastični oslonci (sylan blok , sferalastik...)

Materijali:

NR , NBR ...

Čelik



GUMENO METALNI AMORTIZERI

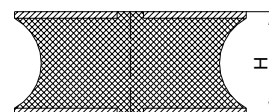
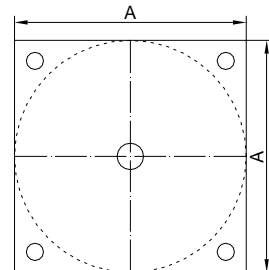
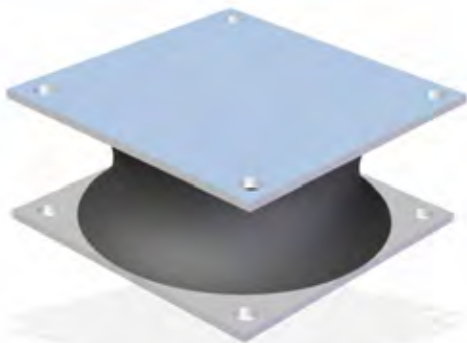
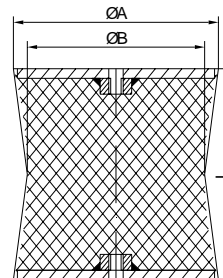
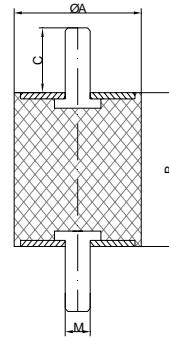
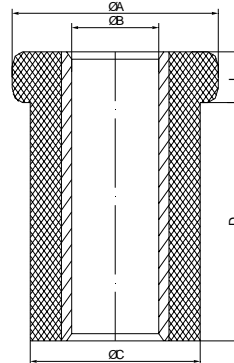

GUMENO METALNI AMORTIZER

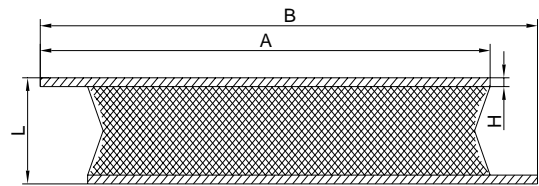
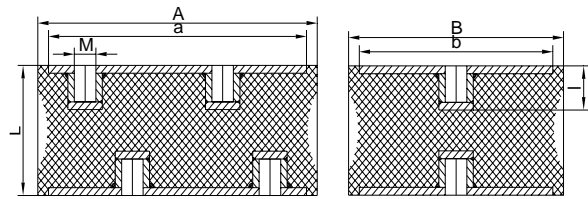

SYLAN BLOK

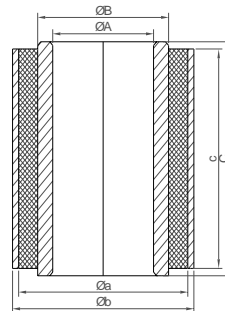

SVERALASTIK

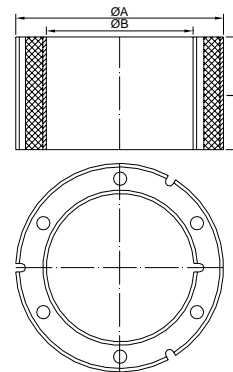

GUMENO METALNA AMORTIZER

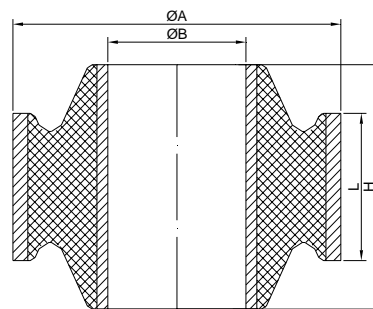

KOMPENZATOR

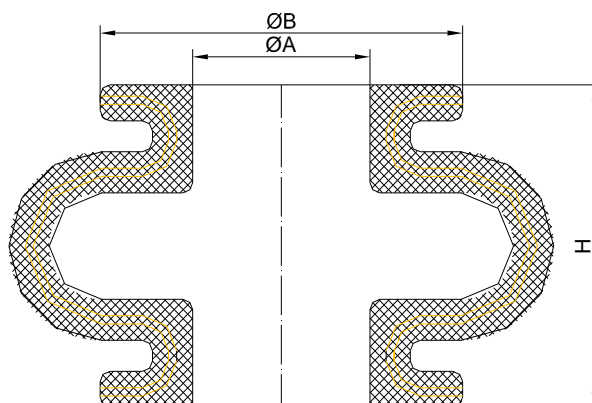
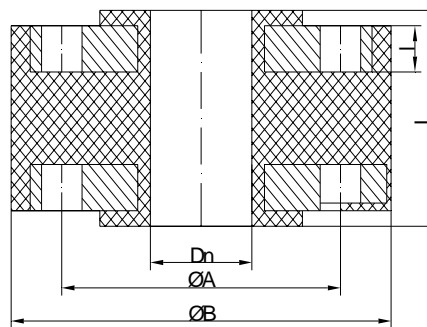

GUMENO METALNI SEGMENT

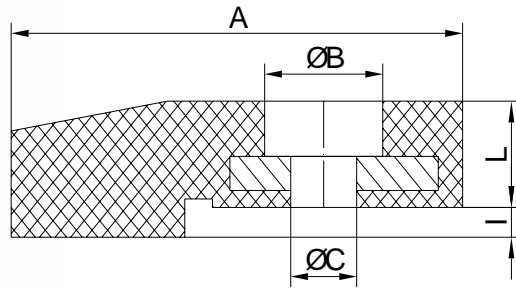

GUMENO METALNA STOPA

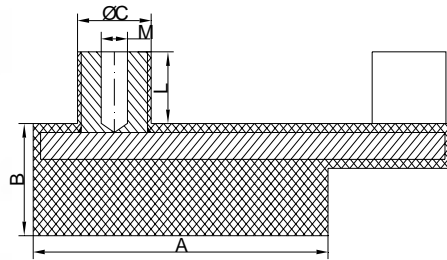
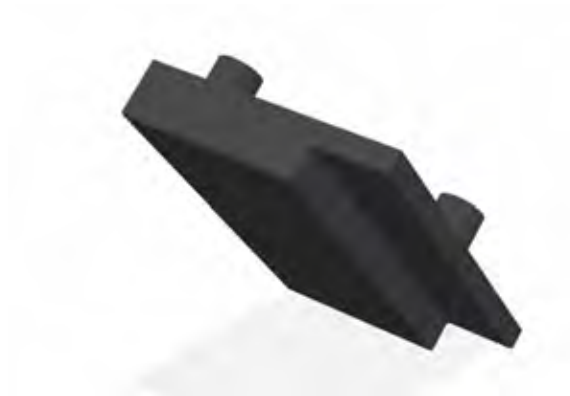

GUMENI AMORTIZERI

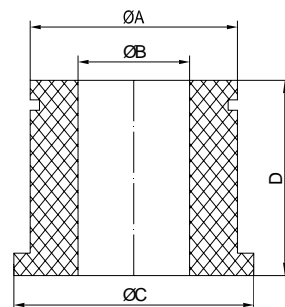

GUMENI AMORTIZERI

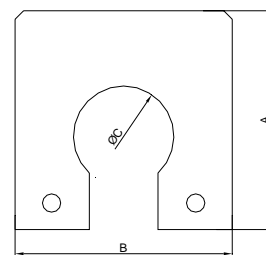
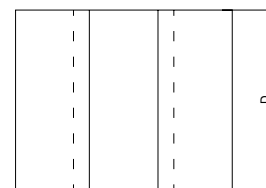
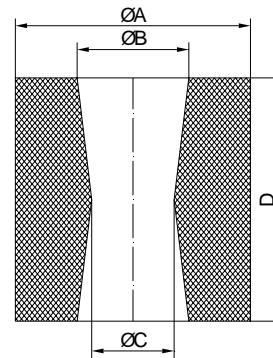
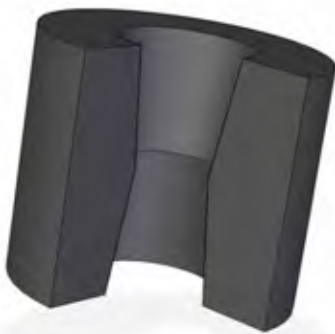
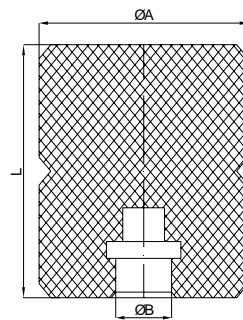
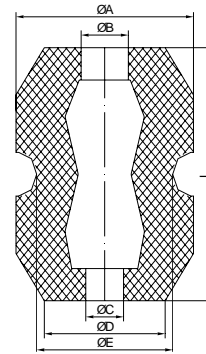

GUMENO METALNI ODBOJNIK

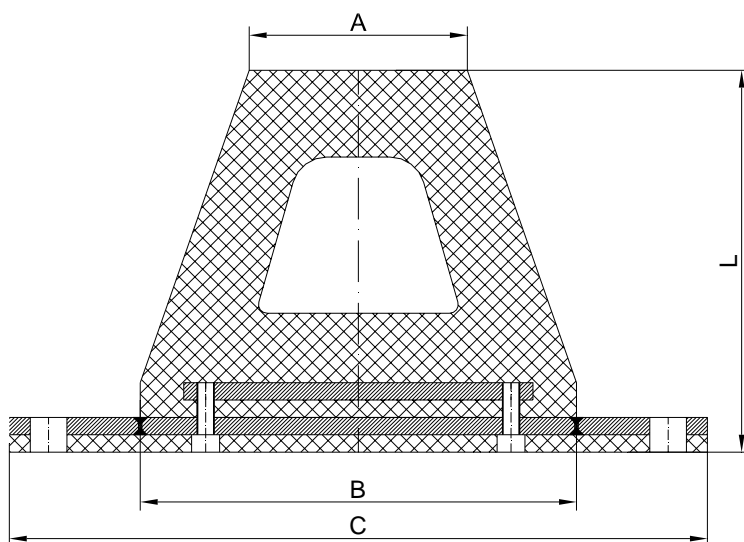

GUMIRANI VALJCI TRANSPORTNIH UREĐAJA I SISTEMA

Oblast primene:

Trakasti transporteri , frikcioni prenosnici , valjci , etiketir mašine ,
grafički valjci ...

Materijali:

NR , NBR , EPDM , VMQ , PU...

Pamučna , poliesterska i poliamidna platna...

Čelik ,PA , legure lakih metala...



GUMENO-METALNI VALJCI

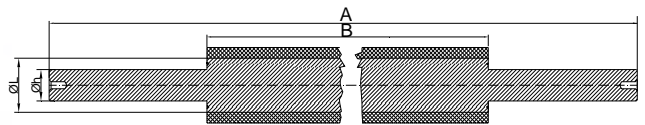
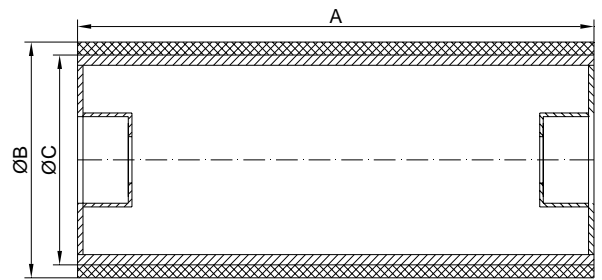
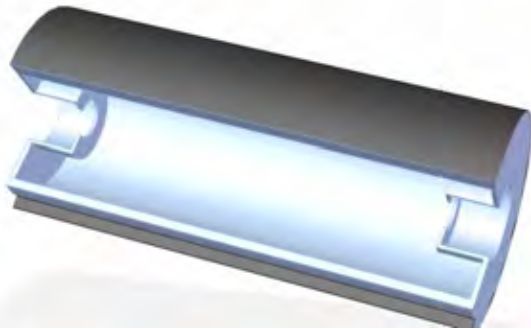
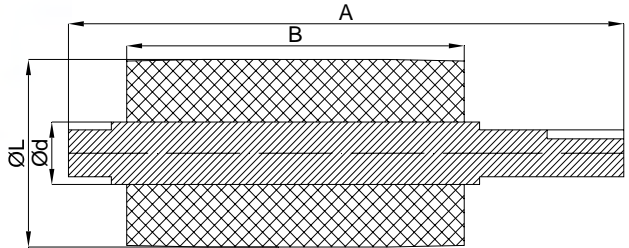
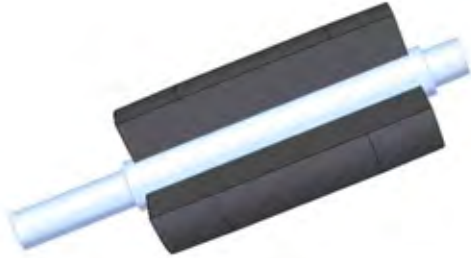

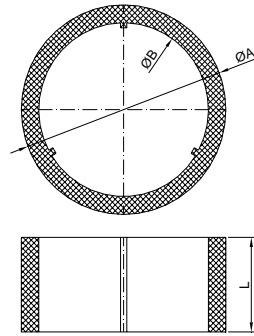
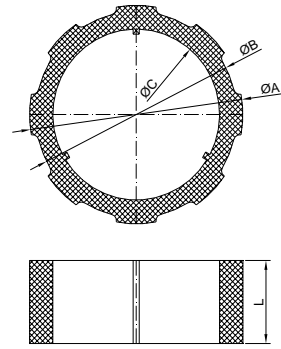

POGONSKA GUMENA ZVEZDA NA LINIJI BOCA

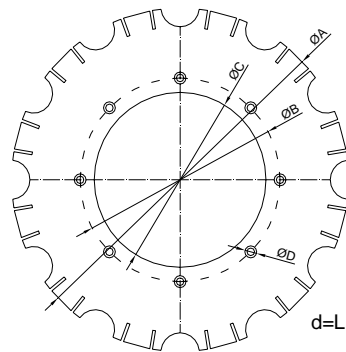

ANTISTATIK GUMA-ALUMINIJUM, GUMA-PLASTIKA

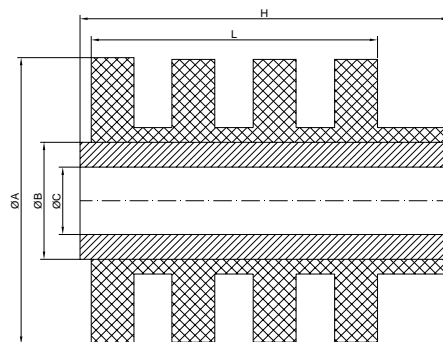
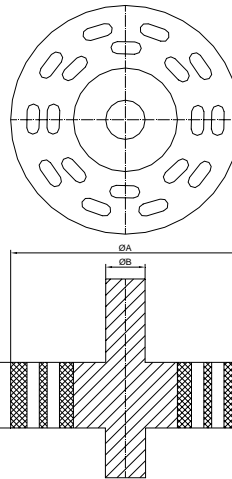
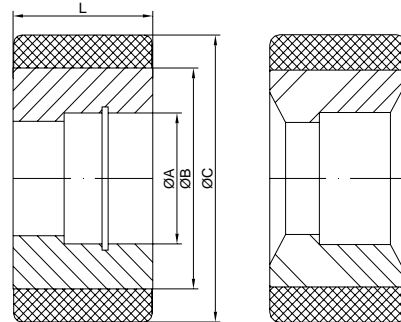

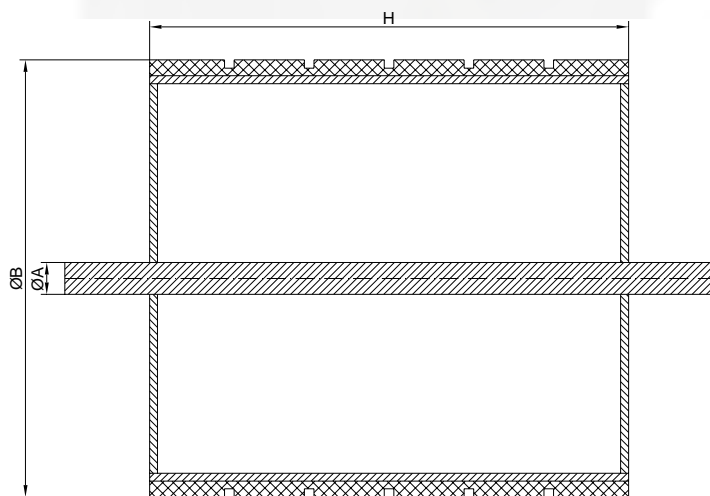
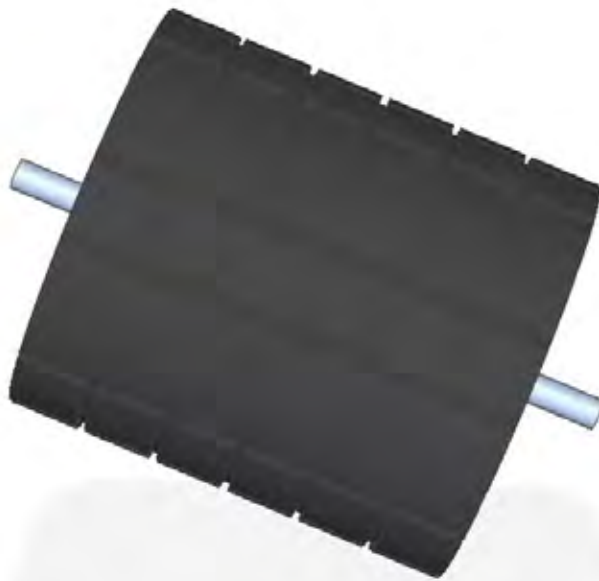
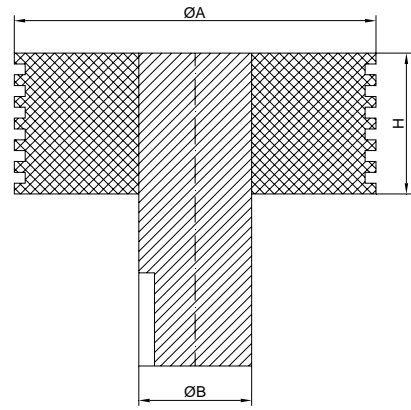
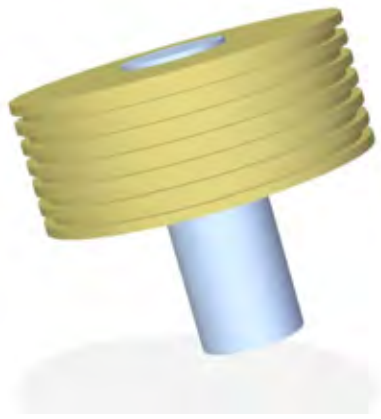

GUMENI I GUMENO-METALNI TOČKOVI

Oblast primene:

Delovi mašina za niskogradnju i visokogradnju u oblasti građevinarstva...

Materijali:

NR , NBR , PU , PA , POM ...

Pamučna , poliesterska i poliamidna platna...

Čelik , legure lakih metala...



TOČKOVI GLODALICE ASFALTA (WIRTGEN)

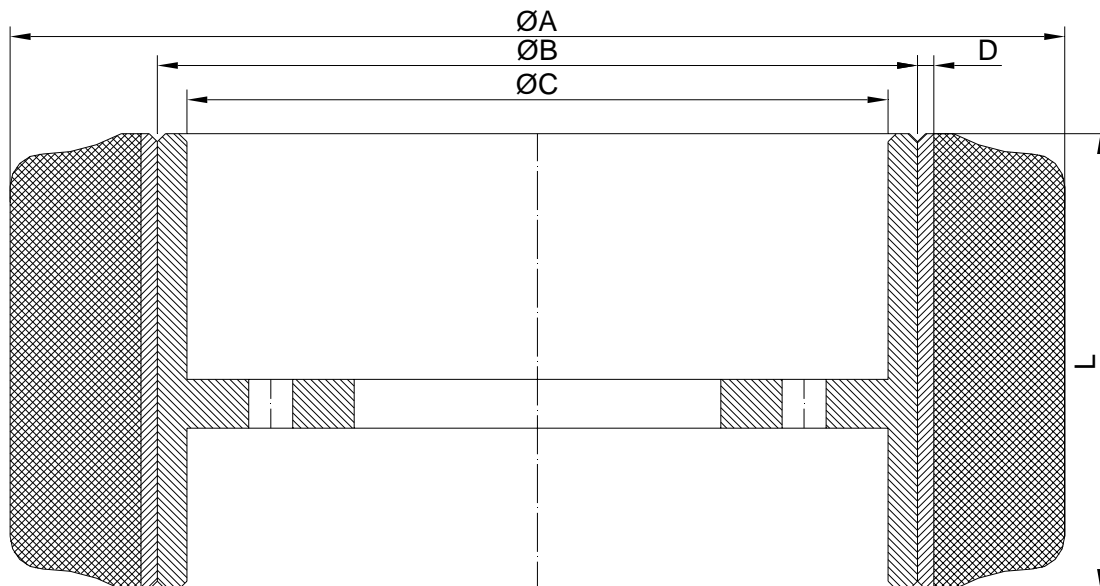

TOČAK GUMENO-METALNI

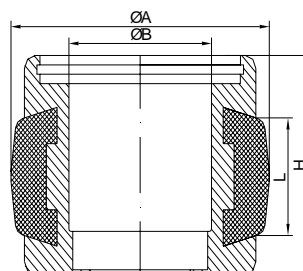
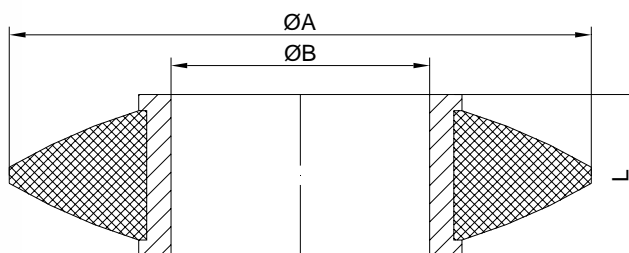
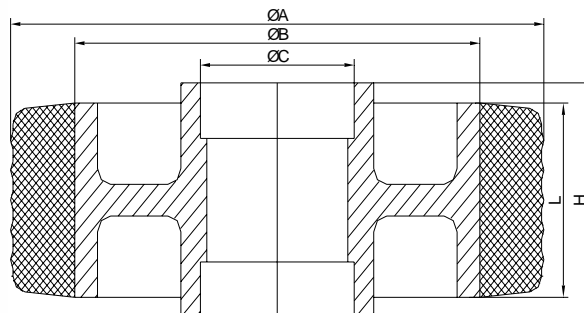

PLASTIKA-METAL

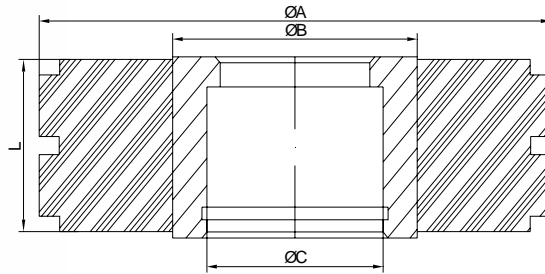

TOČAK DEKANTERA

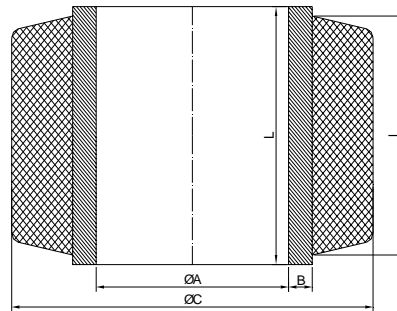

ANTISTATIK GUMA-ALUMINIJUM, GUMA-PLASTIKA

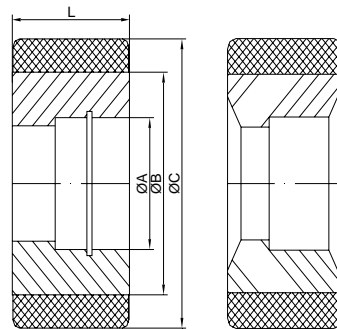

PAPUČE GLODALICE ASFALTA

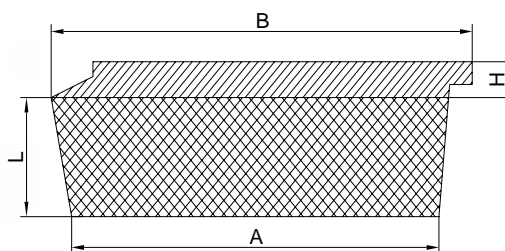
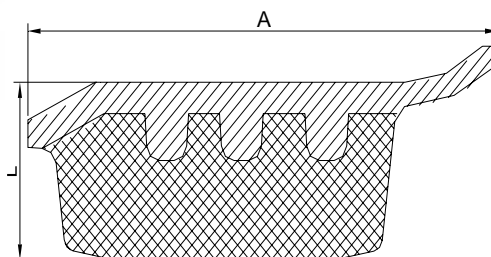

GUMENI PROIZVODI RAZNIH NAMENA

Oblast primene:

Delovi za statičko zaptivanje , filtraciju , zaštitu sklopova , skidanje materijala sa transportnih traka.

Materijali:

NR ,SBR, NBR,CR,IIR,EPDM,VMQ,EU,FKM



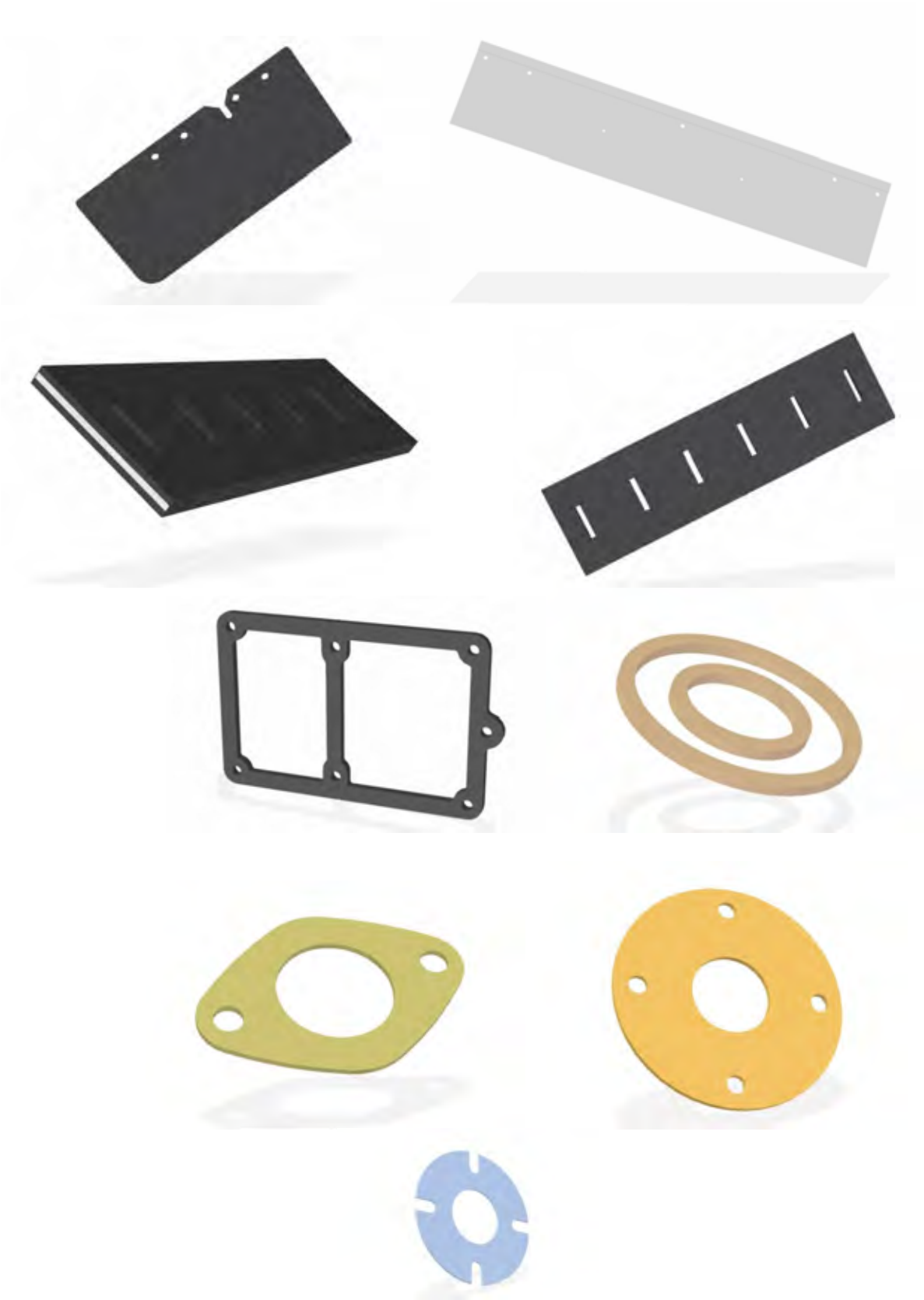

PROFILI,KEDERI

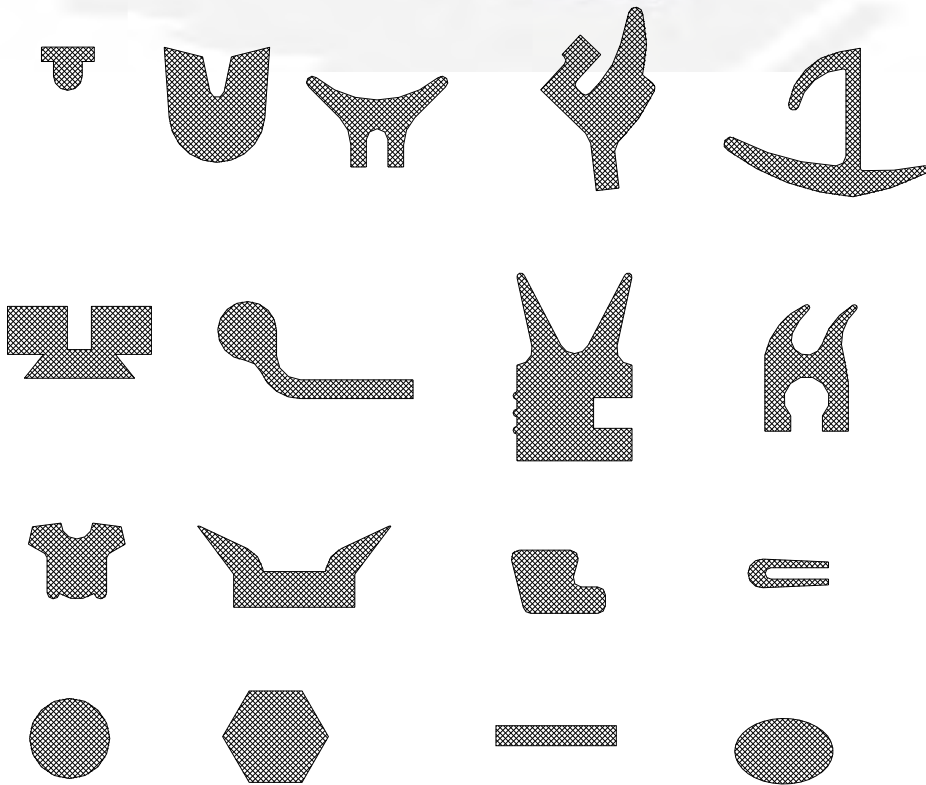
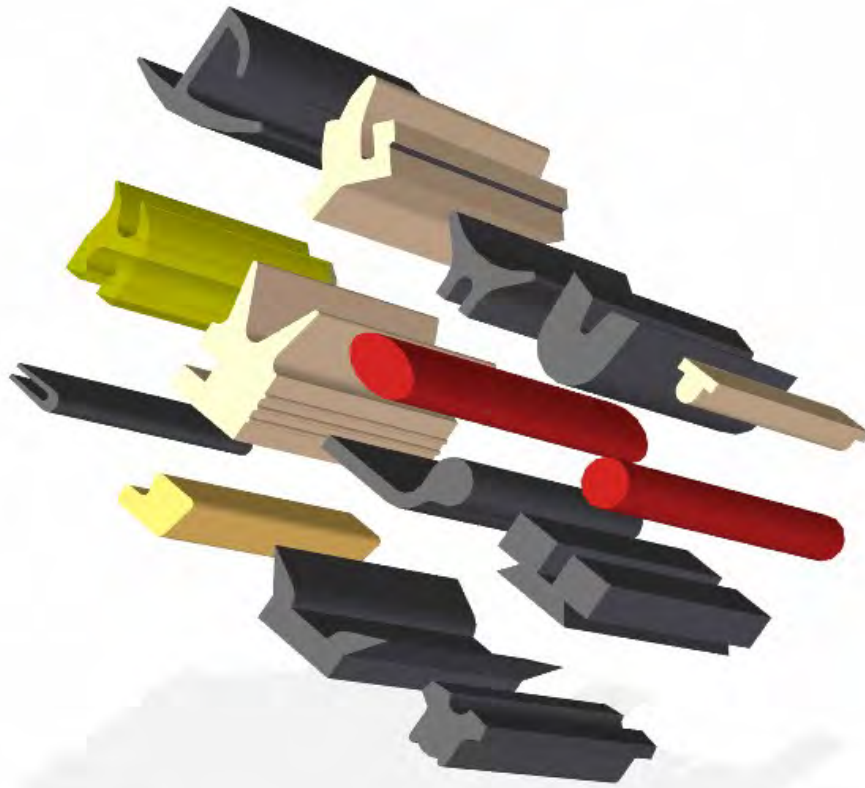

ISPITIVANJE I PAKOVANJE PROIZVODA

