



Marking laser

Integrated or column-mounted systems



► Laser RANGE

i103L-G

c173L-G



Integrated laser i103L-G



User-friendly

- Can be used with or without PC

Powerful laser

- Deep and fast marking thanks to a 50 W source (option)

Versatility, high speed marking and precision:

- Marks various types of materials
- Surface or hollow marking
- Standard 1D (bar-codes) and 2D (UID compliant Data Matrix) code capability
- High definition graphical images or logos
- High marking quality

Robust, reliable and economical:

- Extended component life expectancy
- Maintenance free
- Warranty up to 5 years

Column-mounted laser c173L-G



i103L-G integration drawings

Laser controller

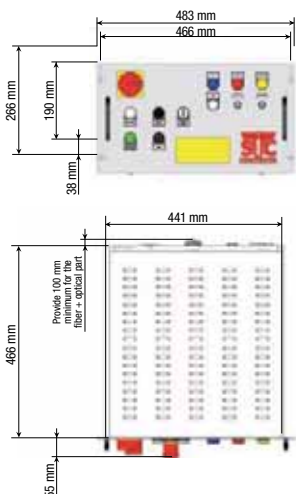

Marking head

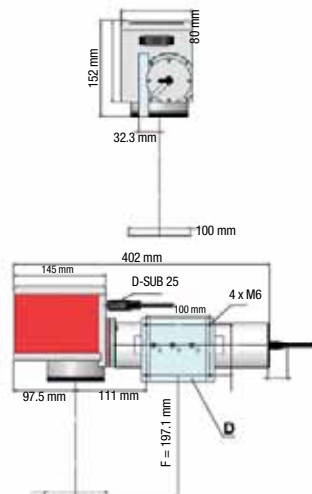

Working principle



Galvanometric head

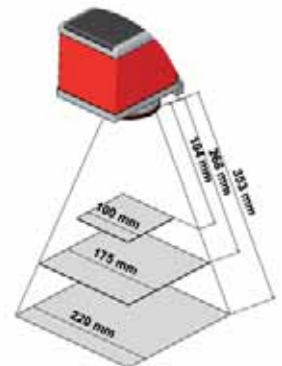

Pyramid of marking fields

LASER TECHNICAL FEATURES

Integrated laser

i103L-G

Standard marking field 100 x 100 mm / 3.9 inches
(option up to 220 x 220 mm / 8.7 inches)

Standard focal distance 160 mm / 6.3 inches (dependent on optics used)

Weight Controller: 30 Kg / 66 lb - Head: 8 Kg / 18 lb

Security Class 4 configuration (EN60825-1 standard)

Control Without PC

Column-mounted laser

c173L-G

Standard marking field 175 x 175 mm / 6.9 inches
(option up to 220 x 220 mm / 8.7 inches)

Weight 45 Kg / 99 lb

Security Class 1 configuration (EN60825-1 standard)

Control PC-based operation

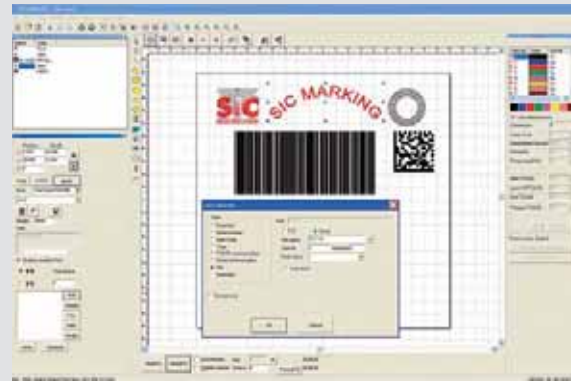
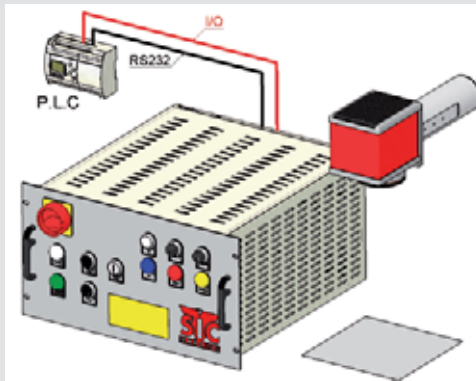

OPTIONS



Tag feeder



Rotary (D) axis

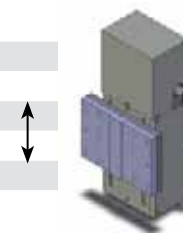

Z axis, stroke 50 mm / 2 inches to 250 mm / 9.84 inches



Integrated vision system (mark verification)



Bar-code and Data Matrix reader

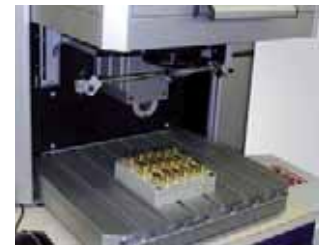

Custom tooling



Automatic door



Custom housing (automatic door)

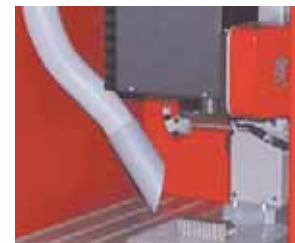

Fume extraction system



Source: Pulsed Ytterbium fiber laser
Operation mode: Pulsed (20 to 80 KHz)
Wavelength: 1 064 nm
Fiber length: 3 m / 118 inches
Average power: 20 W (50 W optional)
Peak power: 10 kW
Positioning / focus: built-in laser pointer
Cooling: Air-cooled only
Warranty : 24 months (except for optics). Warranty extension up to 5 years available.

APPLICATION EXAMPLES



SIC Marking® ACTIVITIES



MARKING EXAMPLES



SIC Marking® equipment is available worldwide. Contact us to be directed towards a distributor serving your area.



SIC Marking®
 13, route de Limonest
 Zac de la Braille
 69380 Lissieu - France
 Tél. : +33 (0)4 72 54 80 00
 Fax : +33 (0)4 78 47 39 40
www.sic-marking.com
info@sic-marking.com

