

Express Catalogue

- Temperature Sensors
- Special Cables

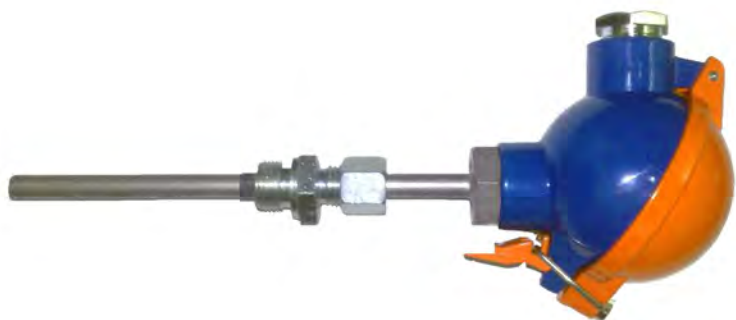

UJETA CO

Temperature Sensors and Special Cables

A FEW WORDS ABOUT THIS CATALOGUE 6

TEMPERATURE SENSORS SECTION 7

- Series BMR** - Resistance thermometer head type suitable for measuring temperatures of liquids and gases with screw in mounting fitting 8
- Series BMR** - Resistance thermometer head type suitable for measuring temperatures of liquids and gases with adjustable screw in compression fitting 9
- Series BMR** - Resistance thermometer head type suitable for measuring temperatures of liquids and gases with adjustable screw in compression fitting 10
- Series TWT**- Temperature sensors with screwed bar stock thermowell for process technology (chemical and petrochemical plant, pressure vessels, etc.), are preferably used for measuring temperatures in liquids and gasses. 11
- Series TWF/1**- Temperature sensors with Flanged bar stock thermowell for process technology (chemical and petrochemical plant, pressure vessels, etc.), are preferably used for measuring temperatures in liquids and gasses. 12
- Series BMRM** - Exhaust gas temperature sensors with solid drilled protection tube. For measuring and regulation exhaust gas, temperature in stationary and marine. Suitable for measuring diesel engines, turbines and compressors. 13
- Series MS** - Exhaust gas temperature sensors insert type with miniature socket for measuring and regulation exhaust gas, temperature in stationary and marine diesel engines, turbines and compressors. 14
- Series MS** - Exhaust gas temperature sensors insert type with miniature socket for measuring and regulation exhaust gas, temperature in stationary and marine diesel engines, turbines and compressors. 15
- Series JG** - Resistance thermometer with mini terminal head form J suitable for measuring temperatures of liquids and gases 16
- Series JG** - Resistance thermometer with mini terminal head form J suitable for measuring temperatures of liquids and gases 17
- Series JG** - Resistance thermometer suitable for measuring temperatures for food industry in liquids and gases 18
- Series CON** – CON 37 Temperature sensors are heavy duty that can be used for controlling cooling water, lubrication oil, hydraulic oil and refrigeration plants within general industry and Marine Application 19
- Series BMF** – Thermocouples with terminal head form B. Preferred choice for measuring temperatures in liquids and gases. Application includes heating installations, ovens, furnaces and plant engineering 20
- Series BK** – Incinerator thermocouple with Terminal Head Form KNE. Preferred choice for measuring temperatures of primary and secondary combustion chambers. Application includes Ovens and Furnaces. 21
- Series AK** - Thermocouples with Terminal Head Form A. Preferred choice for measuring temperatures in liquids and gases. Application includes Heating Installations, Ovens, Furnaces and Plant Engineering 22
- Series AKK** – Thermocouple with Terminal Head Form A. Preferred choice for measuring temperatures in liquids and gases. Application includes heating installations, ovens, furnaces and plant engineering. 23
- Series AM** - Thermocouples with terminal head form A. Preferred choice for measuring temperatures in liquids and gases. Application includes heating installations, ovens, furnace and plant engineering. 24
- Series BMF** - Duct Resistance thermometer for HVAC 25
- Series RM** - Outdoor resistance thermometer for HVAC applications mainly used for measuring temperatures outdoors 26
- Series RM** - Outdoor resistance thermometer for HVAC applications mainly used for measuring temperatures outdoors 27
- Series RM** - Indoor resistance thermometer for HVAC applications mainly used for measuring

Temperature Sensors and Special Cables

Series RM - Resistance thermometer for refrigerated warehouses & outdoors	29
Series CB - Resistance thermometer with PVC extension cable Preferred for temperature measurement of liquids, gases, solids such as hot plates and welding jaws. Application includes HVAC and refrigeration, heating installations, ovens, plant engineering and laboratories.	30
Series CB - Resistance thermometer with silicon extension cable Preferred for temperature measurement of liquids, gases, solids such as hot plates and welding jaws. Application includes HVAC and refrigeration, heating installations, ovens, plant engineering and laboratories.	31
Series CB - Resistance thermometer with Teflon extension cable Preferred for temperature measurement of liquids, gases, solids such as hot plates and welding jaws. Application includes HVAC and refrigeration, heating installations, ovens, plant engineering and laboratories.	32
Series RM UTECO Surface Temperature Sensor is an adhesive foil sensor. Designed for measurement on surface and is primarily used for temperature measurements of solar installations with terminal box IP65 fitted transmitter 4-20mA	33
Series CB - Encapsulated resistance thermometer cable type IP68 Preferred for temperature measurement of liquids and gases.	35
Series CB - Resistance thermometer with fiber glass – braided extension cable. Preferred for temperature measurement in dry environments at temperature range between 0°C and +400°C	36
Series CB - Thermocouple with fiber glass – braided with extension cable preferred use in measuring temperatures of gases, on solids, welding jaws, heating installations, ovens and plant engineering.	37
Series CBBR - Thermocouple and resistance thermometers with bayonet lock Preferred for measuring temperatures in solids, on bearings and molding tools.	38
Series SUR - Surface resistance thermometer and thermocouple ring type Preferred use for measuring temperatures on round or flat surfaces of closed pipe systems	40
Series SUR - Film surface resistance thermometer Preferred for temperature measurement of round or flat surfaces	41
Series SUR - Slot Surface Sensor For temperature measurement on surfaces and is primarily used for temperature measurement in solar installations.	42
Series THR - Heavy-Duty Industrial Thermocouple Wire Shielded Extension Cables up to 703° C	43
Series CBW - Thermocouple temperature sensor with cable and single protection tube. Preferred for measuring temperature exhaust system. Excellent vibration proof and shock proof.	44
Series CBR - Resistance thermometer with connection cable and single protection tube excellent vibration proof and shockproof performances at high temperature, preferred for measuring temperature exhaust system.	46
Series MIC – Flexible mineral insulated thermometer (type Mantel). Preferred for temperature measurement of temperatures in pipe and tank systems e.g. in oil tankers, or part of a volume measuring system.	47
Series MIC - Mineral insulated thermocouple (type Mantel) Preferred for temperature measurement of liquids and gases on solids such as hot plates and welding jaws. Application include heating installations, ovens, plant engineering and laboratories.	48
Series CON – Mineral Insulated thermocouples with standard male connector, are used in chemical plant, power stations, pipelines in engine construction and on test beds.	49
Series INS - Food temperature Insertion Resistance Thermometer Particularly suitable for cooking and baking processes in all areas of food processing and preservation.	50
Series INS - Food temperature Insertion Resistance Thermometers are particularly suitable for cooking and baking processes in all areas of food processing and preservation with stainless steel flexible tube.	51
Series PRT - Portable temperature sensor type K (NIR-NI) Suitable for measurement in gases, fluids and liquids.	52
Series PRT - High temperature handheld probes for bigieta (solid bar) surface measurement. For temperature from 0 to 1260°C Type K (NICR-NI) measures hot metal surfaces. Especially designed for heavy duty.	53
Head mounted 2-wire transmitter d TRANS T03 B PT100 - 4-20mA.	54
Head mounted transmitter d TRANS T03 BU PT100 - from 0 to 10V 3-wire Temperature Transmitter for Head-Mounting	55
Head mounted transmitter APAQ-HCF T/C for thermocouple input, 4-20mA output.	56
DIN Rail transmitter d trans T03T PT100, 4-20mA output	57

Temperature Sensors and Special Cables

DIN Rail universal- programmable transmitter d TRANS T02 PCP	60
Series TWT - Screw-in pocket for systems where drain- or pressure- less installations / exchanging of thermocouples or resistance thermometers are required.	61
Series TWF - Flanged bar stock thermowells with tapered stem	62
Miniature Connector with thermocouple material contacts	63
Standard Connector with thermocouple material contacts	64
Standard panel with Thermocouple material contacts	65
Series Conductive - Level sensors for conductive limit value detection	66
Series Conductive - Level sensors for conductive limit value detection	67
SPECIAL CABLES SECTION	69
INSTRUMENTATION & BUS CABLES	70
DATA & CONTROL CABLES	71
COMPENSATING & EXTENSION CABLES	72
HIGH TEMPERATURE CABLES	73
INTERNATIONAL COLOR CODE FOR COMPENSATING & EXTENSION CABLES	74
ORDERING FORM	75

Temperature Sensors and Special Cables

A few words about this catalogue

Dear Customers,

You will find below a standardized list of —Temperature sensors & Special cables— from us, which are always in stock at our warehouse, capable of solving the immediate need of the most demanding applications.

The catalogue includes code, type, basic technical description and a photo for visual recognition of our product.

Those are indicative list:

Temperature sensors with different measuring range, length, construction material, process connection etc. are also available.

Cables with different numbers of cores or pairs, different sections (mm²), insulation or color codes (standard), etc. are also available.

T

Temperature Sensors Section



Temperature Sensors

Temperature Sensors and Special Cables

Series BMR - Resistance thermometer head type suitable for measuring temperatures of liquids and gases with screw in mounting fitting

Type	Diameter	Length	Temperature	Ordering Nr.	Price (€)
1 x Pt100	8mm	100mm	260° C	407ZE8B428	
1 x Pt100	8mm	100mm	400° C	407ZE8B432	
2 x Pt100	8mm	100mm	260° C	407HE8B408	
2 x Pt100	8mm	100mm	400° C	407HE8B406	



Specifications

Resistance type and tolerances:	resistance thermometer PT100, Class B, single or double, IEC 751, 2, 3, 4 or 6 wire system
Outside diameter:	8mm
Sheath material:	AISI 316 Ti
Process connection:	R1/2 BSP
Probe length:	100mm
Temperature range:	from -50° C to +400° C
Terminal head:	TYPE BUZ IP 65

Other technical characteristics (length, diameter, connector etc.), available upon request.

Temperature Sensors and Special Cables

Series BMR - Resistance thermometer head type suitable for measuring temperatures of liquids and gases with adjustable screw in compression fitting

Type	Diameter	Length	Temperature	Ordering Nr.	Price (€)
1 x Pt100	10mm	300mm	400° C	407ZHEB419	



Specifications

Resistance type and tolerances:	resistance thermometer PT100, Class B, single or double, IEC 751, 2, 3, 4 or 6 wire system
Outside diameter:	10mm
Sheath material:	AISI 316 Ti
Process connection:	R1/2 BSP ERMETO (adjustable)
Probe length:	300mm
Temperature range:	from -50° C to +400° C
Terminal head:	TYPE BUZ IP 65

Other technical characteristics (length, diameter, connector, etc.), available upon request.

Temperature Sensors and Special Cables

Series BMR - Resistance thermometer head type suitable for measuring temperatures of liquids and gases with adjustable screw in compression fitting

Type	Diameter	Length	Temperature	Process Connection	Ordering Nr.	Price (€)
1 x Pt100	12mm	100mm	0-650° C	R 3/4 BSP	407ZI8B539	
1 x Pt100	12mm	110mm	0-650° C	R 3/4 BSP	407ZI9B545	
1 x Pt100	12mm	150mm	0-650° C	R 3/4 BSP	407ZIAB540	
1 x Pt100	12mm	200mm	0-650° C	R 3/4 BSP	407ZIBB546	
1 x Pt100	15mm	200mm	0-650° C	R 3/4 BSP	407ZMBB520	
1 x Pt100	15mm	250mm	0-650° C	R 3/4 BSP	407ZMGB520	
1 x Pt100	12mm	250mm	0-650° C	R 3/4 BSP	407ZIGB521	
1 x Pt100	15mm	300mm	0-650° C	R 3/4 BSP	407ZMEB505	
1 x Pt100	12mm	80mm	0-200° C	R 3/4 BSP	407ZI6B519	
1 x Pt100	12mm	100mm	0-200° C	R 3/4 BSP	407ZI8B540	
1 x Pt100	12mm	150mm	0-200° C	R 3/4 BSP	407ZIAB544	



Specifications

Resistance type and tolerances:	resistance thermometer PT100, Class B, 3 wire system
Outside diameter:	12mm or 15mm
Sheath material:	AISI 316 Ti Nr.14571
Process connection:	R ¾ BSP
Probe length:	80mm - 300mm
Temperature range:	from -50° C to +650° C
Terminal head:	Cast Aluminum IP65

Other technical characteristics (length, diameter, connector, etc.), available upon request.

Temperature Sensors and Special Cables

Series TWT- Temperature sensors with screwed bar stock thermowell for process technology (chemical and petrochemical plant, pressure vessels, etc.), are preferably used for measuring temperatures in liquids and gasses.

Type	Stem Size	Immersion Length	Extension Nipple/Union	Process Connection	Ordering Nr.	Price (€)
1 x Pt100	18x14mm	100mm	100mm	½ NPT	452ZP8B401	
4-20mA	18x14mm	100mm	100mm	½ NPT	452ZP8B402	

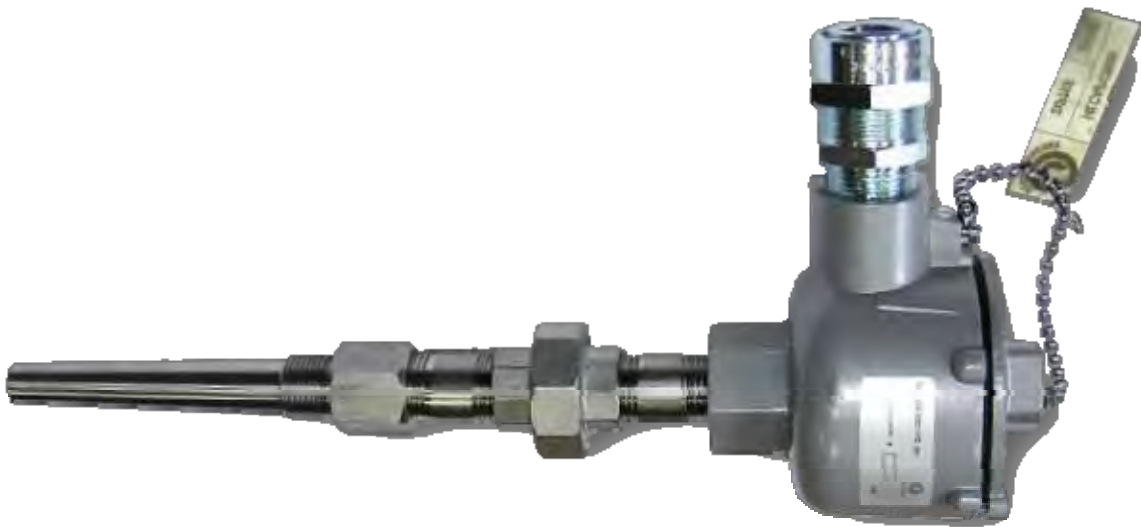

Specifications

The measuring insert is fitted with resistance thermometer PT100 to EN 60751, CLASS A with 2,3 or 4 wire system. With replaceable measuring insert D6mm (mineral insulated cable).

Stem diameter under thread:	18mm
Tip diameter:	14mm
Tip thickness:	4mm
Immersion length:	100mm
Extension length:	100mm
Connection head:	weather proof , cast-aluminum IP65, Form EExd
Ambient temperature:	from -20° C to +130° C
Process connection:	R ½ NPT
Material:	AISI 316L
Bore:	7mm

Available with 2-wire transmitter (4-20mA/HART/In Ex version)

Other technical characteristics (length, diameter, process connection, etc.), available upon request.

Temperature Sensors and Special Cables

Series TWF/1- Temperature sensors with Flanged bar stock thermowell for process technology (chemical and petrochemical plant, pressure vessels, etc.), are preferably used for measuring temperatures in liquids and gasses.

Type	Stem Size	Immersion Length	Ordering Nr.	Price (€)	
1 x Pt100 4-20mA	22x19mm 22x19mm	300mm 300mm	190mm 190mm	1- ½" 150 RF 1- ½" 150 RF	451ZSEBP02 451ZSEBP01

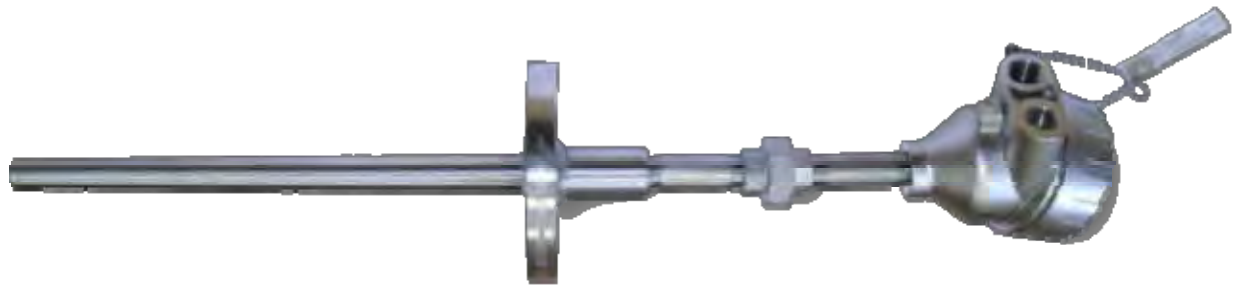

Specifications

The measuring insert is fitted with resistance thermometer PT100 to EN 60751, CLASS A with 2,3 or 4 wire system. With replaceable measuring insert D6mm (mineral insulated cable).

Stem diameter under flange:	22mm
Tip diameter:	19mm
Tip thickness:	4mm
Immersion length:	300mm
Extension length:	190mm
Connection head:	weather proof , INOX AISI 316, IP68, Form Exd, (Flameproof)
Ambient temperature:	-50 to +150° C
Flange size:	1- ½" 150 RF
Material:	AISI 316L
Bore:	7mm

Available with 2-wire transmitter (4-20mA/HART/In Ex version)

Other technical characteristics (length, diameter, flange size, etc.), available upon request.

Temperature Sensors and Special Cables

Series BMRM - Exhaust gas temperature sensors with solid drilled protection tube. For measuring and regulation exhaust gas, temperature in stationary and marine. Suitable for measuring diesel engines, turbines and compressors.

Type	Stem Size	Length			Temperature Range	Price (€)
1 x Pt100	18x14mm	80mm	0-650°C	G ½	406ZP6B401	
1 x Pt100	18x14mm	100mm	0-650°C	G ½	406ZP8B401	
1 x Pt100	18x14mm	80mm	0-650°C	G ¾	406ZT6B501	
1 x Pt100	18x14mm	100mm	0-650°C	G ¾	406ZT8B501	
1 x Pt100	18x14mm	150mm	0-650°C	G ¾	406ZTAB501	
1 x Pt100	18x14mm	200mm	0-650°C	G ¾	406ZTBB501	
1 x Pt100	18x14mm	250mm	0-650°C	G ¾	406ZTGB501	

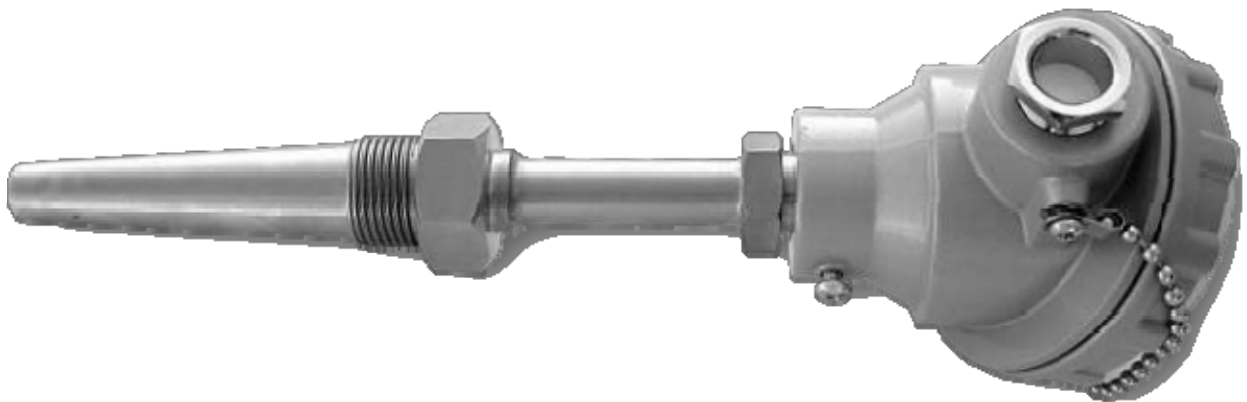

Specifications

PT100 Thin film Technology specially developed for heavy duty application. Screwed bar stock thermowells with tapered stem.

Resistance type and tolerance:	Resistance thermometer PT100, CLASS B, IEC 751, 2 wire or 3 wire system.
Stem diameter under thread:	18mm or 23mm
Tip diameter:	14mm
Tip thickness:	4mm
Extension length:	50mm
Immersion length:	80mm, 100mm, 150mm, 200mm, 250mm
Connection head:	weather proof , heavy duty head with screw on cover IP65
Temperature range:	from 0 to +650° C
Material:	AISI 316
Bore:	9mm

Other technical characteristics (length, diameter, connector, etc.), available upon request.

Temperature Sensors and Special Cables

Series MS - Exhaust gas temperature sensors insert type with miniature socket for measuring and regulation exhaust gas, temperature in stationary and marine diesel engines, turbines and compressors.

Type	Diameter	Length		Temperature Range	Ordering Nr.	Price (€)
1 x Pt100	8mm	150mm	0-650°C	AISI 316 Ti	443ZEAB003	
1 x Pt100	8mm	175mm	0-650°C	AISI 316 Ti	443ZEAB010	
1 x Pt100	8mm	190mm	0-650°C	AISI 316 Ti	443ZEAB011	
1 x Pt100	8mm	250mm	0-650°C	AISI 316 Ti	443ZEGB002	

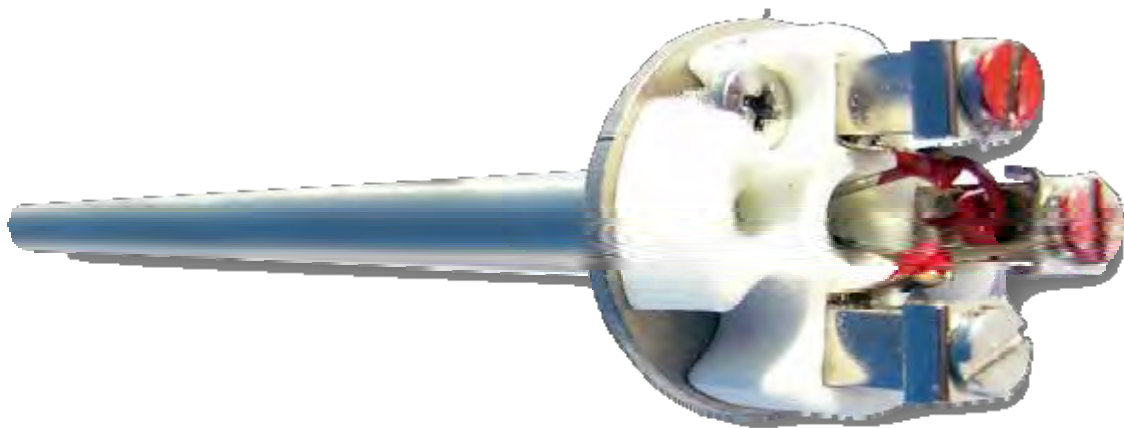

Specifications

Resistance type and tolerance:	Resistance thermometer PT100, CLASS B, IEC 751, 2 wire or 3 wire system.
Probe outer diameter:	8.0mm
Probe immersion length:	150mm, 170mm, 190mm, 250mm
Terminal blocks:	form J ceramic Ø25.1mm (miniature socket)
Temperature range:	from 0 to +650° C

Other technical characteristics (length, diameter, connector, etc.), available upon request.

Temperature Sensors and Special Cables

Series MS - Exhaust gas temperature sensors insert type with miniature socket for measuring and regulation exhaust gas, temperature in stationary and marine diesel engines, turbines and compressors.

Type	Diameter	Length	Temperature Range	Material	Ordering Nr.	Price (€)
1 x Pt100	3mm	315mm	-50 +400°C	AISI 316	443Z4EB002	
1 x Pt100	6mm	405mm	-50 +400°C	AISI 316	443ZAHB001	
1 x Pt100	8mm	170mm	-50 +600°C	AISI 316	443ZEBB002	
1 x Pt100	8mm	220mm	-50 +600°C	AISI 316	443ZEGB002	
1 x Pt100	8mm	270mm	-50 +600°C	AISI 316	443ZEEB002	
1 x K	3mm	315mm	-200 +1150°C	Inconel 600	44344ZE001	
1 x K	6mm	405mm	-200 +1150°C	Inconel 600	4434AHE001	
1 x K	4.5mm	385mm	-200 +1150°C	Inconel 600	44347HE003	
1 x K	8mm	330mm	-200 +800°C	AISI 316	4434EZB002	

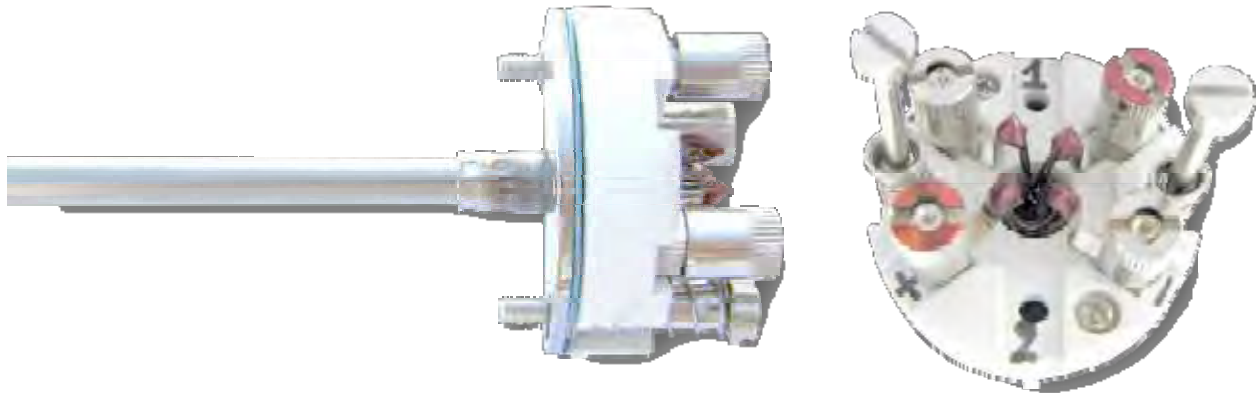

Specifications

The measuring inserts are normally fitted with a temperature sensor PT100 to IEC 751, CLASS B with 2, 3 or 4 wire system. The measuring insert with thermocouple is according to Class 2 of IEC 584, versions with Fe-konst, or NI CROSIL-NISIL can also be supplied.

Tube diameter:	3mm, 4,5mm, 6mm , 8mm
Probe length:	170mm, 220mm, 315mm, 385mm, 405mm
Terminal block:	form B Diameter 42mm
Temperature range:	from -200 to +1150°C

Available with transmitter output 4-20 mA or 0-10 V

Version with PT500 or PT1000 can also be supplied. Also as single or twin insert.

Other technical characteristics (length, diameter, connector, etc.), available upon request.

Temperature Sensors and Special Cables

Series JG - Resistance thermometer with mini terminal head form J suitable for measuring temperatures of liquids and gases

Type	Diameter	Length	Temperature Range	Ordering Nr.	Price (€)
1 x Pt100	7mm	50mm	260°C	AISI 316 Ti	4237D3B402

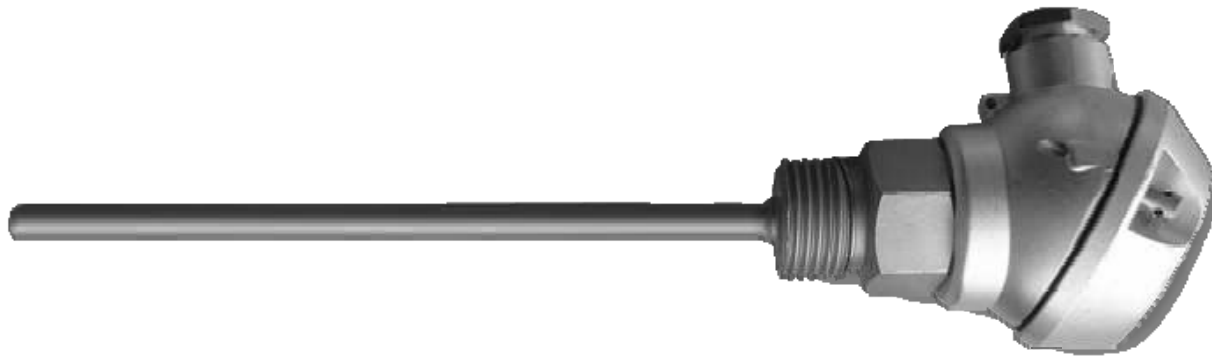

Specifications

Resistance type and tolerances:	Resistance thermometer PT100, Class A, IEC 751, 2, 3, or 4 wire system
Outside diameter:	7mm
Sheath material:	AISI 316 Ti
Process connection:	Thread R1/2 BSP
Probe length:	50mm
Temperature range:	from -50° C to +260° C
Terminal head:	mini terminal head form J Pg9, IP54

Other technical characteristics (length, diameter, connector, etc.), available upon request.

Temperature Sensors and Special Cables

Series JG - Resistance thermometer with mini terminal head form J suitable for measuring temperatures of liquids and gases

Type	Diameter	Length	Temperature Range	Temperature Range	Ordering Nr.	Price (€)
2 x Pt100	8mm	155mm	-50 +260° C	AISI 316 Ti	423HEAB401	
2 x Pt100	8mm	360 mm	-50 +260° C	AISI 316 Ti	423HEZB401	
2 x Pt100	8mm	690 mm	-50 +260° C	AISI 316 Ti	423HEMB401	



Specifications

Resistance type and tolerances:	Resistance thermometer PT100, Class B, IEC 751,3 wire system
Outside diameter:	8mm
Sheath material:	AISI 316 Ti
End Tip:	40mm
Process connection:	thread ½ pipe
Probe length:	155mm, 360mm, 690mm
Temperature range:	-50° C to +260° C
Terminal head:	mini terminal head form J Pg9, IP54

Other technical characteristics (length, diameter, connector, etc.), available upon request.

Temperature Sensors and Special Cables

Series JG - Resistance thermometer suitable for measuring temperatures for food industry in liquids and gases

Type	Diameter	Length	Temperature Range	Ordering Nr.	Price (€)
1 x Pt100	3mm	33mm	-50 +260° C	AISI 316 Ti	423742B011

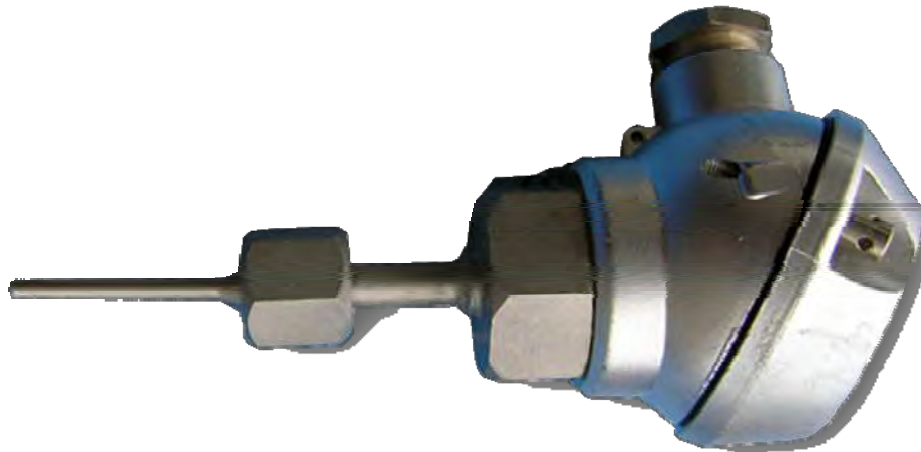

Specifications

Resistance type and tolerances:	resistance thermometer PT100, Class A, IEC 751, 2, 3, or 4 wire system
Outside diameter:	3mm
Sheath material:	AISI 316 Ti
End Tip:	20mm
Process connection:	Thread R1/8 BSP female
Probe length:	33mm
Temperature range:	from -50° C to +260° C
Terminal head:	terminal head form J, Aluminum die – Casting, Pg9, IP54

Other technical characteristics (length, diameter, connector, etc.), available upon request.

Temperature Sensors and Special Cables

Series CON – CON 37 Temperature sensors are heavy duty that can be used for controlling cooling water, lubrication oil, hydraulic oil and refrigeration plants within general industry and Marine Application

Type	Diameter	Length	Temperature Range	Ordering Nr.	Price (€)
1 x Pt100	8x1mm	50mm	-50 +200° C	G ½A	437ZE3B401
1 x Pt100	8x1mm	100mm	-50 +200° C	G ½A	437ZE8B401
1 x Pt100	8x1mm	150mm	-50 +200° C	G ½A	437ZEAB401
1 x Pt100	8x1mm	50mm	-50 +200° C	G ¾A	437ZE3B501
1 x Pt100	8x1mm	100mm	-50 +200° C	G ¾A	437ZE8B501
1 x Pt100	8x1mm	150mm	-50 +200° C	G ¾A	437ZEAB501



Specifications

The measuring insert is fitted with resistance thermometer PT100 to IEC 751, CLASS B with 2 or 3 wire systems. Version with PT100 or PT1000 Resistance element.
Gold plated male and female connector CON 37 with interchangeable measuring insert.

Probe outer diameter:	8mm
Probe length:	50mm, 150mm, 200mm
Process connection:	thread G1/2, G3/4A or ½-14 NPT
Temperature range:	from -50 to +260° C
Connector:	DIN 43650/PG 13.5mm

Other technical characteristics (length, diameter, connector, etc.), available upon request.

Temperature Sensors and Special Cables

Series BMF – Thermocouples with terminal head form B. Preferred choice for measuring temperatures in liquids and gases. Application includes heating installations, ovens, furnaces and plant engineering

Type	Diameter	Length	Temperature Range	Ordering Nr.	Price (€)
1 x K	15.2mm	250mm	from 0 to +1150° C	1.4841	4014MG0002
1 x K	15.2mm	500mm	from 0 to +1150° C	1.4841	4014MI0001
1 x K	15.2mm	710mm	from 0 to +1150° C	1.4841	4014MM1001
1 x K	15.2mm	1000mm	from 0 to +1150° C	1.4841	4014MP1001
2 x K	15.2mm	500mm	from 0 to +1150° C	1.4841	4015MIA001
2 x K	15.2mm	700mm	from 0 to +1150° C	1.4841	4015MM0001
2 x K	15.2mm	1000mm	from 0 to +1150° C	1.4841	4015MP1001
2 x K	15.2mm	1400mm	from 0 to +1150° C	1.4841	4015MS1001



Specifications

The measuring insert is fitted with thermocouple according to Class 2 of IEC 584

Probe diameter:	15x2mm
Sheath material:	EN 1.4841
Process connection:	stop flange 15mm dia DIN 43734
Probe length:	250mm, 500mm, 710mm, 1000mm, 1400mm
Temp. range:	from 0 to +1150° C
Terminal head:	form B DIN 43729 Aluminum die casting IP54
Transmitter:	Programmable Transmitter, Output 4-20ma/20-4 ma can also be supplied

Other technical characteristics (length, diameter, connector, etc.), available upon request.

Temperature Sensors and Special Cables

Series BK – Incinerator thermocouple with Terminal Head Form KNE.
Preferred choice for measuring temperatures of primary and secondary combustion chambers. Application includes Ovens and Furnaces.

Measurement insert	Diameter	Length	Temperature Range	Price (€)
1 x S (PtRh-Pt 10%)	10x2mm	250mm	+1600° C	4056HGN001
1 x S (PtRh-Pt 10%)	10x2mm	500mm	+1600° C	4056HUN001
1 x R (PtRh-Pt 13%)	10x2mm	710mm	+1600° C	4058HEN001
1 x K (NICROSIL–NISIL)	15x2mm	1000mm	+1300° C	405CMEN001
1 x K (NiCr –Ni)	15x2mm	500mm	+1200° C	4054MDN001



Specifications

The measuring insert is fitted with thermocouple according to Class 2 of IEC 584

Ceramic probe outer diameter:	10x2mm, 15x2mm
Metallic support tube:	15mm (for ceramic tube 10mm) 22mm (for ceramic tube 15mm)
Process connection:	Screwed pipe point ¾ BSP
Probe immersion length:	250mm, 300mm, 450mm
Temp. range:	from 0 to +1600° C
Terminal head:	weather proof with screw on cover and chain
Material:	C799 cast- Aluminum
Conduit entry thread:	M20x1,5

Other technical characteristics (length, diameter, connector, etc.), available upon request.

Temperature Sensors and Special Cables

Series AK - Thermocouples with Terminal Head Form A. Preferred choice for measuring temperatures in liquids and gases. Application includes Heating Installations, Ovens, Furnaces and Plant Engineering

Measurement insert	Diameter	Length	Temperature Range	Price (€)
1 x K	15.2mm	350mm	+1200° C	4154MZN001
1 x N	15.2mm	350mm	+1300° C	415CMZN001
1 x S	15.2mm	350mm	+1400° C	4156MZN001
1 x R	15.2mm	350mm	+1400° C	4158MZN001
1 x S	15.2mm	500mm	+1400° C	4156MIN001
1 x S	15.2mm	700mm	+1400° C	4156MMN001
1 x S	15.2mm	1000mm	+1400° C	4156MPN001
1 x N	15.2mm	1300mm	+1300° C	415CMIN001
1 x K	15.2mm	1200mm	+1200° C	4154MIN001



Specifications

The measuring insert is fitted with thermocouple according to Class 2 IEC 584
Available with twin thermocouple diameter wire 0,35mm, for PTRH Pt and 3mm for Type N and K

Probe diameter:	15mm
Support tube:	22mm (material 1.4841)
Probe length:	350mm, 500mm, 700mm, 1000mm
Temperatur range:	from -200 to +1400° C
Terminal head:	form A DIN 43729 Aluminum die casting IP54
Version Transmitter:	Programmable Transmitter, Output 4-20ma/20-4 ma can also be supplied

Other technical characteristics (length, diameter, connector, etc.), available upon request.

Temperature Sensors and Special Cables

Series AKK – Thermocouple with Terminal Head Form A. Preferred choice for measuring temperatures in liquids and gases. Application includes heating installations, ovens, furnaces and plant engineering.

Measurment insert	Diameter	Length	Temperat Range	Ordering Nr.	Price (€)
1 x N	24x18mm	700mm	+1300° C	KER610	417CTMP001
1 x N	24x18mm	10000mm	+1300° C	KER610	417CTPP002
1 x S	24x18mm	1000mm	+1400° C	KER610	4176TPP002
1 x R	24x18mm	1000mm	+1400° C	KER610	4178TPP001
1 x B	24x18mm	700mm	+1600° C	C799	417ATMN001
1 x B	24x18mm	1000mm	+1600° C	C799	417ATPN001
1 x S	24x18mm	700mm	+1500° C	C799	4176TMN001
1 x S	24x18mm	1000mm	+1500° C	C799	4176TPN001
1 x S	24x18mm	1000mm	+1400° C	C530	4176YPR001



Specifications

The thermocouple insert is fitted with thermocouple according to Class 2 IEC 584

Available with twin thermocouple diameter wire 0,35mm, for PTRH Pt (S,R), 0,5 for PTRH Pt (B) and 3mm for type N

Probe diameter:	24x18mm for ceramic C610 or C799 26x18mm for ceramic C530
Support tube:	32mm (material AISI 316SS)
Process connection:	Screwed pipe point 1-1/2" Stop flange 32mm diam. To DIN 43734
Probe length:	700mm, 1000mm, 1400mm
Temperatur range:	from -200 to +1600° C
Terminal head:	form A DIN 43729 Aluminum die casting IP54
Version Transmitter:	Programmable Transmitter, Output 4-20ma/20-4 ma can also be supplied

Other technical characteristics (length, diameter, connector, etc.), available upon request.

Temperature Sensors and Special Cables

Series AM - Thermocouples with terminal head form A. Preferred choice for measuring temperatures in liquids and gases. Application includes heating installations, ovens, furnace and plant engineering.

Measurement insert	Diameter in mm	Length in mm	Temperature Range	Material	Ordering Nr.	Price (€)
1 x K	22x2	710	+1150° C	1.4841		
1 x K	22x2	1000	+1150° C	1.4841		
1 x K	22x2	1200	+1150° C	1.4841		
2 x K	22x2	1000	+1150° C	1.4841		
2 x K	22x2	1200	+1150° C	1.4841		
1 x K	22x2	1400	+1150° C	1.4841		
1 x K	21.3x2.6	710	+1150° C	4C54(14749)		
1 x K	21.3x2.6	1000	+1150° C	4C54(14749)		
1 x K	21.3x2.6	1200	+1150° C	4C54(14749)		
2 x K	21.3x2.6	1200	+1150° C	4C54(14749)		



Specifications

The thermocouple insert is fitted with thermocouple according to Class 2 IEC 584
 Available with twin thermocouple diameter wire 0,35mm, for PTRH Pt (S,R), 0,5 for PTRH Pt (B) and 3mm for type N

Probe diameter:	24x18mm for ceramic C610 or C799 26x18mm for ceramic C530
Support tube:	32mm (material AISI 316SS)
Process connection:	Screwed pipe point 1-1/2" Stop flange 32mm diam. To DIN 43734
Probe length:	700mm, 1000mm, 1400mm
Temperature range:	from -200 to +1600° C
Terminal head:	form A DIN 43729 Aluminum die casting IP54
Version Transmitter:	Programmable Transmitter, Output 4-20ma/20-4 ma can also be supplied

Other technical characteristics (length, diameter, connector, etc.), available upon request.

Temperature Sensors and Special Cables

Series BMF - Duct Resistance thermometer for HVAC

Measurement insert	Diameter	Length	Temperature Range	Ordering Nr.	Price (€)
1 x Pt100	8mm	200mm	from -50°C to +260°C	435ZEBO02	
1 x Pt1000	8mm	200mm	from -50°C to +260°C	435KEBO01	
0-10V	8mm	200mm	from 0°C to +50°C	435ZEBO01	
4-20mA	8mm	200mm	from -30°C to +60°C	435ZEBO05	

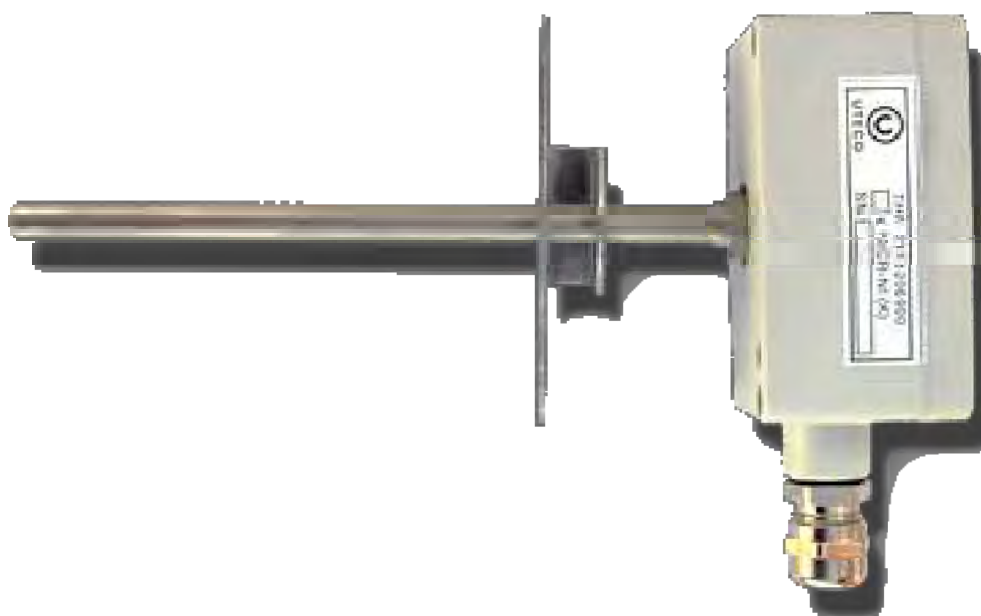

Specifications

The measuring insert is normally fitted with a Pt100 or Pt1000 Temperature Sensor to IEC 951 Class A in 2-wire, 3-wire and 4-wire circuit.

Terminal Box:	Plastic PVC housing IP65
Protection Tube:	Stainless steel 1-4571 diameter 8mm
Immersion length:	200mm
Transmitter:	analog transmitter, output 4 – 20 mA or 0-10V

Other versions available with Pt500, Ni 1000, Ni 120, NTC 10 K Ω , KTx 11-6 can also be supplied.

Other technical characteristics (length, diameter, connector, etc.), available upon request.

Temperature Sensors and Special Cables

Series RM - Outdoor resistance thermometer for HVAC applications mainly used for measuring temperatures outdoors

Measurement insert	Output	Temperature Range	Ordering Nr.	Price (€)
1 x Pt100	1xPt100	from -30°C to +80°C	435ZO00012	
1 x Pt100	0-10V	from -50°C to +50°C	435Z00B001	
1 x Pt100	4-20 mA	from -30°C to +60°C	435Z000007	
1 x Pt1000	1xPt1000	from -30°C to +80°C	435K61B001	



Specifications

The measuring insert is normally fitted with a Pt100 or Pt1000 Temperature Sensor to IEC 951 Class A in 2-wire, 3-wire and 4-wire circuit.

Resistance type and tolerances:	Resistance thermometer Pt100 or Pt1000 class A accuracy $\pm 0,150^{\circ}\text{C}$ to 0°C , IEC751 3-wire system
Terminal Box:	Plastic PC housing IP65
Transmitter:	analog transmitter, output 4 – 20 mA or 0-10V
Versions:	Pt500, Ni1000, Ni120, or NTC10K Ω can also be supplied

Temperature Sensors and Special Cables

Series RM - Outdoor resistance thermometer for HVAC applications mainly used for measuring temperatures outdoors

Measurement insert	Cable length	Temperature Range	Ordering Nr.	Price (€)
1 x Pt100	3m	from -50°C to +90°C	435Z000100	
1 x Pt1000	3m	from -50°C to +90°C	435K000100	



Specifications

Resistance type an tolerance thermometer P+100 or P+1000 class A accuracy $\pm 0,15^{\circ}\text{C}$ (IEC 751), 2 or 3 system wire

Terminal box:	Material PA6, Color: pure white similar to RAC 9010
Cable entry:	PE 14
Protection:	IP65
Terminal Clamp:	Screwing terminal max 1,5mm ² Version Pt500, Ni 1000, NTC 10K Ω , KTY 21-5 can also be supplied
Cable length:	3m
Cable insulation:	PVC-PVC (3 x 0,35mm ²)

Temperature Sensors and Special Cables

Series RM - Indoor resistance thermometer for HVAC applications mainly used for measuring temperatures in rooms

Measurement insert	Output	Temperature Range	Ordering Nr.	Price (€)
1 x Pt100	1xPt100	from -30 to +80°C	435ZO00000	
1 x Pt100	4-20 mA	from 0 to +50°C	435ZO00004	
1 x Pt100	0-10V	from 0 to +50°C	435ZO00013	
1 x Pt1000	1xPt1000	from -30 to +80°C	435KO00000	



Specifications

Resistance type an tolerance thermometer P+100 or P+1000 class A accuracy $\pm 0,15^{\circ}\text{C}$ (IEC 751), 2 or 3 system wire

Resistance type and tolerances:	Resistance thermometer Pt100 or Pt1000 class A accuracy $\pm 0,15^{\circ}\text{C}$ to 0°C , IEC751 3-wire system
Terminal Box:	Plastic PC housing IP20
Transmitter:	analog transmitter, output 4 – 20 mA or 0-10V
Versions:	Pt500, Ni1000, Ni120, or NTC10K Ω can also be supplied

Temperature Sensors and Special Cables

Series RM - Resistance thermometer for refrigerated warehouses & outdoors

Measurement insert	Diameter	Length		Temperat Range	Price (€)
1 x Pt100	14mm	150mm	from -50 to +260°C	435ZLAB000	
2 x Pt100	14mm	150mm	from -50 to +260°C	435HL98001	
1 x Pt100	8mm	100mm	from -50 to +260°C	435ZE8B005	
4-20MA	8mm	100mm	from -50 to +260°C	435ZE8B003	
0-10V	8mm	100mm	from -50 to +260°C	435ZE8B002	

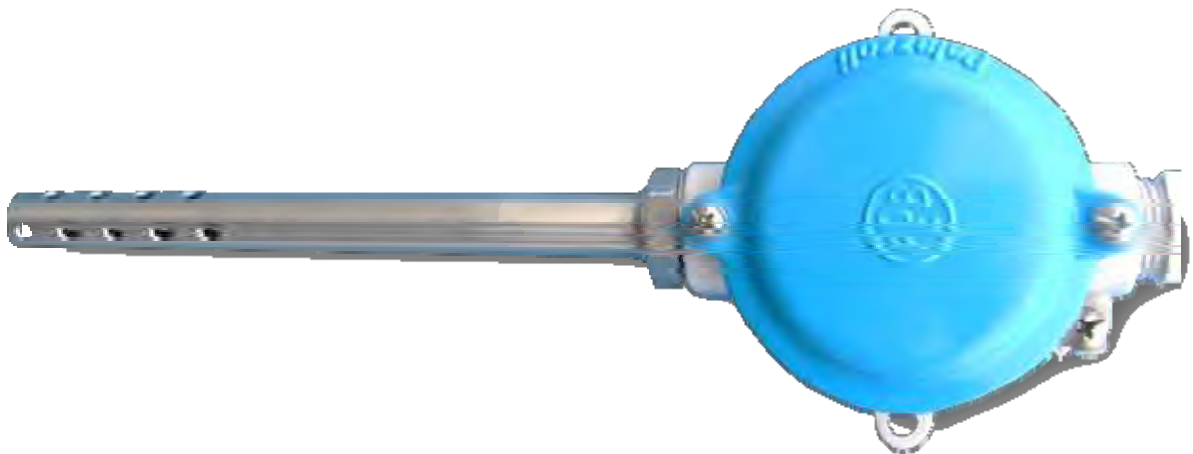

Specifications

The measuring insert is normally fitted with a Pt100 Temp. Sensor to IEC 751 Class A in 2-wire, 3-wire, 4-wire and 6-wire circuit, single or duplex resistance thermometer.

Connection Box:	Material Aluminum, Protection IP65
Protection Tube:	round 14mm stainless steel perforated with open end
Measuring Insert:	Pt100 Class A, 1/3 or 1/5 DIN
Transmitter:	analog transmitter, output signal 4 – 20 mA or 0-10V

Temperature Sensors and Special Cables

Series CB - Resistance thermometer with PVC extension cable Preferred for temperature measurement of liquids, gases, solids such as hot plates and welding jaws. Application includes HVAC and refrigeration, heating installations, ovens, plan engineering and laboratories.

Measurement insert	Diameter	Length	Cable length	Ordering Nr.	Price (€)
1 x Pt100	6mm	50mm	3m	425ZA3B003	
1 x Pt100	6mm	50mm	5m	425ZA3B058	
1 x Pt1000	6mm	50mm	5m	425KA3B003	
NTC 10ko	6mm	50mm	3m	425XA3B009	
AD 592	6mm	200mm	5m	425XABB001	
KTY 11-6	6mm	50mm	3.5m	425XA2B001	

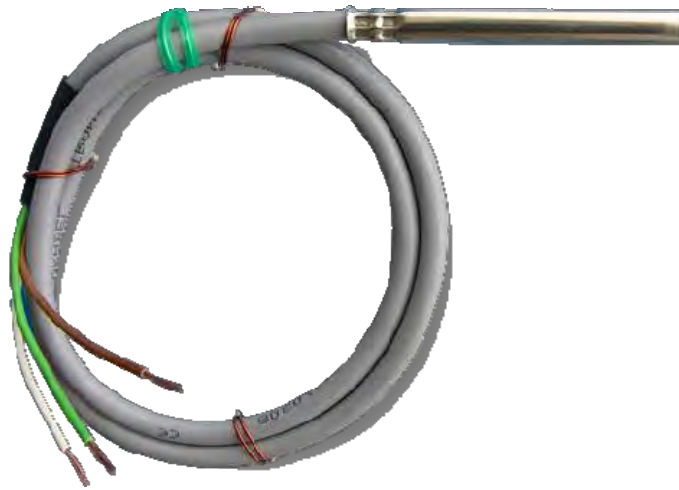

Specifications

Resistance thermometer Pt100 to ICE 751 class A or B available with 2, 3 or 4 wire circuit.

Probe Diameter:	6mm
Probe Length:	50mm, 160mm
Protection tube:	Stainless steel 14571
Protection:	IP 67
Cable insulation:	PVC – PVC (3 x 0,34mm ²)
Temperature:	80° C

Other versions available with Pt1000, Pt500, Ni1000, Ni120, NTC10KΩ, KTY 11-6, KTY84, AD592 (available with single or twin resistance thermometer)

Other technical characteristics (length, diameter, connector etc.) available upon request

Temperature Sensors and Special Cables

Series CB - Resistance thermometer with silicon extension cable Preferred for temperature measurement of liquids, gases, solids such as hot plates and welding jaws. Application includes HVAC and refrigeration, heating installations, ovens, plan engineering and laboratories.

Measurement insert	Diameter	Length	Cable length	Ordering Nr.	Price (€)
1 x Pt100	6mm	50mm	3m	425ZA3B012	
1 x Pt100	6mm	160mm	3m	425ZAAB016	
1 x Pt1000	6mm	50mm	5m	425KA3B013	
KTY 84	6mm	50mm	0.3m	425XA3B010	

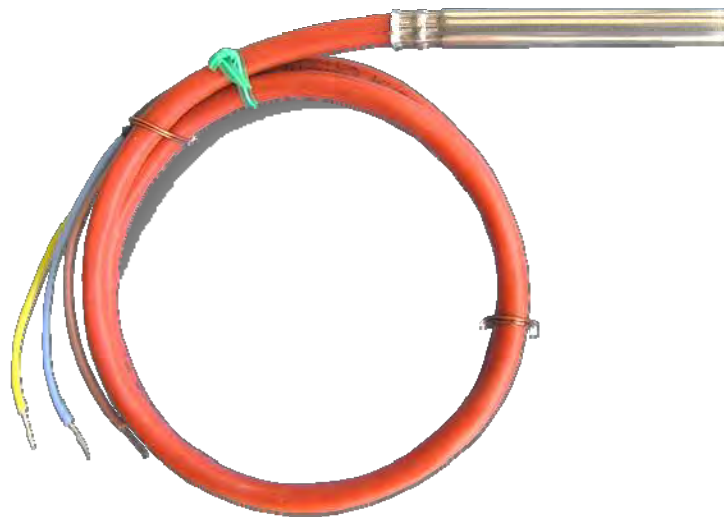

Specifications

Resistance thermometer Pt100 to ICE 751 class A, B or 1/3 DIN available with 2, 3 or 4 wire circuit.

Probe Diameter:	6mm
Probe Length:	50mm, 160mm
Protection Tube:	Stainless steel 14571
Protection:	IP 67
Cable Insulation:	Silicon – Silicon (3 x 0,5mm ²)
Temperature:	180° C

Other versions available with Pt1000, Pt500, Ni1000, Ni120, NTC10KΩ, KTY 11-6, KTY84, AD592 (available with single or twin resistance thermometer)

Other technical characteristics (length, diameter, connector etc.) available upon request

Temperature Sensors and Special Cables

Series CB - Resistance thermometer with Teflon extension cable Preferred for temperature measurement of liquids, gases, solids such as hot plates and welding jaws. Application includes HVAC and refrigeration, heating installations, ovens, plan engineering and laboratories.

Measurment insert	Diameter	Length	Cable length	Ordering Nr.	Price (€)
1 x Pt100	4mm	40mm	1.5m	425Z62B005	
1 x Pt100	3mm	22mm	2m	425Z41B004	
1 x Pt100	3mm	22mm	3m	425Z41B002	



Specifications

Resistance thermometer Pt100 to ICE 751 class A, B or 1/3 DIN available with 2, 3 or 4 wire circuit.

Probe Diameter:	6mm
Probe Length:	50mm, 160mm
Protection Tube:	Stainless steel 14571
Protection:	IP 67
Cable Insulation:	Silicon – Silicon (3 x 0,5mm ²)
Temperature:	180° C

Other versions available with Pt1000, Pt500, Ni1000, Ni120, NTC10KΩ, KTY 11-6, KTY84, AD592 (available with single or twin resistance thermometer)

Other technical characteristics (length, diameter, connector etc.) available upon request

Temperature Sensors and Special Cables

Series SUR UTECO Surface Temperature Sensor is an adhesive foil sensor. Designed for measurement on surface and is primarily used for temperature measurements of solar installations with terminal box IP65 fitted transmitter 4-20mA

Measurement insert	Length	Temperature range	Cable length	Ordering Nr.	Price (€)
4-20 mA	40mm	from -50 to +150°C	1m	433ZP2S001	



Specifications

Resistance type and tolerance: Resistance thermometer PT100, Class A+ -0.15° C to 0° C (IEC 751)
3 wire system

Temperature range:	-50+150° C
Protection mode:	IP66
Connection cable length:	1m with 2 or 3 conductor connection
Dimensions Probe (w/h/d):	20mm/40mm/7mm
Casing probe:	Aluminum plate, including adhesive tape (tesa)
Adhesive foil:	double sided Pe-Foam mounting tape, fully outdoor suitable UV, water and ageing water
Terminal box plastic PC housing temperature:	from -30 to +80° C

By installing the surface temperature sensor at the back of a solar (panel), the panel temperature can be measured. The temperature of solar panels are crucial for their output, because the output decreases by 0,43%k with increasing temperature. By monitoring the temperature at the solar cells, conclusions can be drawn about the behavior of the output curve.

Other technical characteristics (platinum resistance PT1000 or PT100 without terminal box and transmitter) available upon request

Temperature Sensors and Special Cables

Series SUR UTECO Surface Temperature Sensor is an adhesive foil sensor. Designed for measurement on surface and is primarily used for temperature measurements of solar installations.

Measurement insert	dimensions in mm(w/h/d)	Temperature range in °C	Cable length	Ordering Nr.	Price (€)
1 x Pt100	20x40x7	from -50 to +150	3m	433ZP2S001	
1 x Pt1000	20x40x7	from -50 to +150	3m	433KP2S001	



Specifications

Resistance type and tolerance: Resistance thermometer PT100 or Pt1000, Class A+ $\pm 0.15^{\circ}\text{C}$ to 0°C (IEC 751) 3 wire system

Temperature range:	-50+150° C
Protection mode:	IP66
Connection cable length:	3m with 2 or 3 conductor connection
Dimensions Probe (w/h/d):	20mm/40mm/7mm
Casing probe:	Aluminum plate, including adhesive tape (tesa)
Adhesive foil:	double sided Pe-Foam mounting tape, fully outdoor suitable UV, water and ageing water

By installing the surface temperature sensor at the back of a solar (panel), the panel temperature can be measured. The temperature of solar panels are crucial for their output, because the output decreases by 0,43% k with increasing temperature. By monitoring the temperature at the solar cells, conclusions can be drawn about the behavior of the output curve.

Other technical characteristics (platinum resistance PT1000 or PT100 without terminal box and transmitter) available upon request

Temperature Sensors and Special Cables

Series CB - Encapsulated resistance thermometer cable type IP68 Preferred for temperature measurement of liquids and gases.

Type	Diameter	Cable Length	Temperature Range	Ordering Nr.	Price (€)
1 x 100	5mm	5000mm	-50°C +105°C	388103G018	
1 x 1000	5mm	5000mm	-50°C +105°C	388103G021	
10KΩ	5mm	1500mm	-50°C +105°C	3881200013	

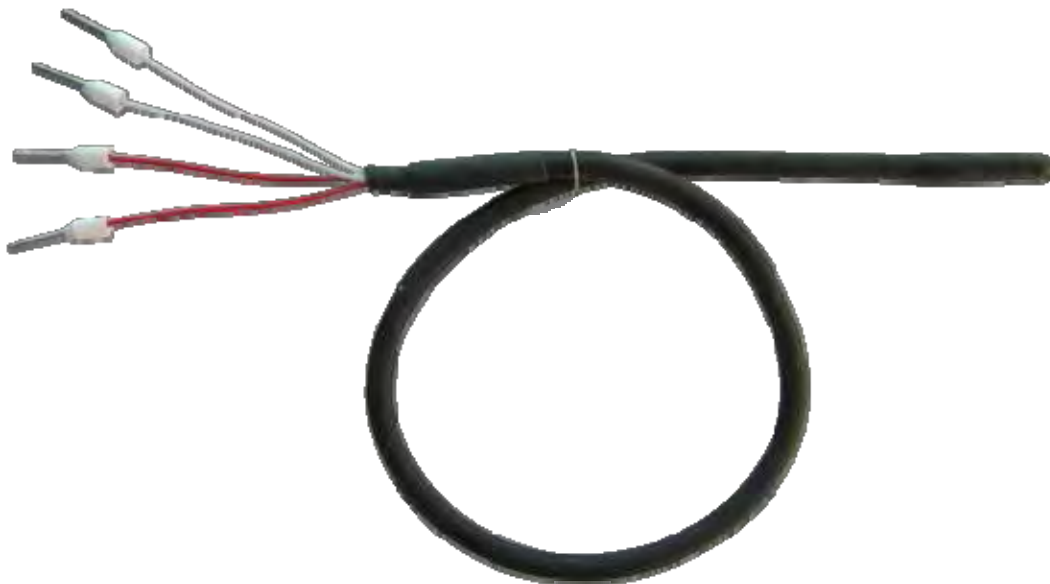

Specifications

Resistance type and tolerances:	resistance thermometer PT100, Class B or A IEC 751 3 or 4 wire system, thermistor $10K\Omega \pm 1\%$ @25°C $B(25/85)=3977 \pm 0.75\%$
Compensating cable:	Stranded copper wires 2 or 4x0,30mm ² (22AWG) with single conductor polypropylene insulation and overall thermoplastic elastomer insulation outer diam. ~3.5mm
Protection:	IP68
Insulation resistance:	100MΩ with 100V DC

Temperature Sensors and Special Cables

Temperature Sensors and Special Cables

Series CB - Resistance thermometer with fiber glass – braided extension cable. Preferred for temperature measurement in dry environments at temperature range between 0°C and +400°C

Type	Diameter	Probe Length	Cable length	Ordering Nr.	Price (€)
1 x Pt100	6mm	50mm	2m	425ZA3B059	
1 x Pt100	6mm	50mm	5m	425ZA3B073	
1 x Pt100	6mm	160mm	1.5m	425ZAAB003	
1 x Pt1000	6mm	50mm	2m	425KA3B007	
1 x Pt1000	8mm	150mm	1.5m	425KEAB001	

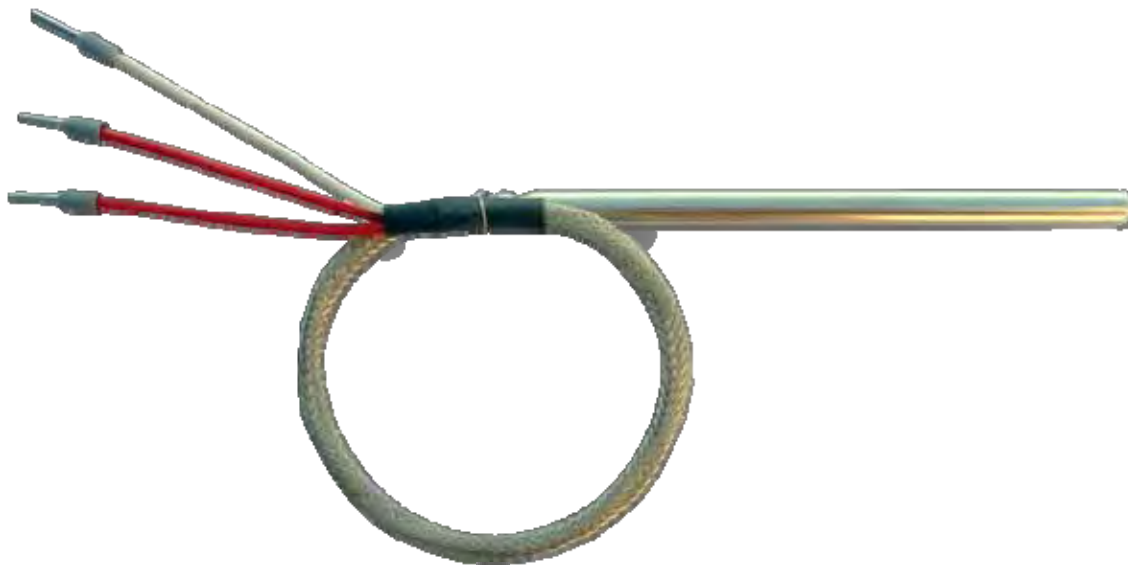

Specifications

Resistance type and tolerances:	resistance thermometer PT100 or PT1000, Class B (single or twin) Accuracy: $\pm 0,20^{\circ}\text{C}$ to 0°C , IEC 751, 2 or 3 or 4 wire circuit
Outside diameter:	6,8mm
Sheath material:	St.St. 1.4571
Probe Length:	50mm, 150mm
Temperature range:	from 0 to +400°C
Cable insulation:	Fiber Glass – Fiber Glass - Braided (3 x 0,5mm ²)

Temperature Sensors and Special Cables

Series CB - Thermocouple with fiber glass – braided with extension cable preferred use in measuring temperatures of gases, on solids, welding jaws, heating installations, ovens and plant engineering.

Measurment insert	Diameter	Length	Cable length	Ordering Nr.	Price (€)
1 x Fe-Konst.	3mm	25mm	1m	425241B004	
1 x Fe-Konst.	4mm	25mm	1m	425261B004	
1 x Fe-Konst.	4mm	40mm	2m	425262B023	
1 x Fe-Konst.	4mm	50mm	1m	425263B003	
1 x Fe-Konst.	5mm	70mm	3m	425295B002	
1 x Fe-Konst.	6mm	30mm	1.5m	4252A2B006	
1 x Fe-Konst.	3mm	80mm	1m	425246B002	
1 x NICR-Ni	4mm	40mm	3m	425462B006	
1 x NICR-Ni	6mm	50mm	6m	4254A3B008	
1 x NICR-Ni	6mm	100mm	3m	4254A8B006	
1 x -CUCU-Ni	4mm	40mm	2.5m	425D62B001	



Specifications

Thermocouple to IEC 584 type of thermocouple J, K, T

Probe Diameter:	3mm,4mm,5mm,6mm,8mm
Probe Length:	25mm,40mm,50mm 70mm, 100mm
Protection tube:	stainless steel 1.4571
Cable insulation:	Fiber Glass – Fiber Glass - Braided (2 x 0,5mm ²)

Other technical characteristics (length, diameter, connector etc.) available upon request

Temperature Sensors and Special Cables

Series CBBR - Thermocouple and resistance thermometers with bayonet lock Preferred for measuring temperatures in solids, on bearings and molding tools.

Measurement insert	Diameter	Probe length	Cable length	Ordering Nr.	Price (€)
Fe-Konst. (J)	8mm	10mm	3m	4302E09117	
Fe-Konst. (J)	8mm	10mm	2m	4302E09118	
Fe-Konst. (J)	8mm	10mm	5m	4302E09103	
Fe-Konst. (J)	8mm	10mm	4m	4302E09119	
1 x Pt100	8mm	10mm	3m	430ZE09101	
1 x Pt100	8mm	10mm	4m	430ZE09110	



Specifications

The measuring insert is normally fitted with thermocouples to IEC 584 Class 2.
The sensor is normally PT100 Temperature sensor to IEC 751, Class B or 3 wire circuit.

Probe Diameter:	8mm
Probe Length:	10mm
Material:	AISI 304
Process connection:	Bayonet lock, 12mm or to be specified R ¼ BSP
Connection cable:	Metal braiding, temperature 0-400°C
Cable insulation:	Fiber Glass – Fiber Glass - Braided (3 x 0,5mm ²)

Temperature Sensors and Special Cables

Series SUR- Surface resistance thermometer with silicon extension cable is used for measuring temperatures on closed pipe work and/ or other round surfaces.

Measurement insert	Dimensions	Material	Temperature range	Cable length	Ordering Nr.	Price (€)
1 x 100	25x15x50	Aluminum	from -50 to +180°C	3m	4-33-ZY-3S-00-1	

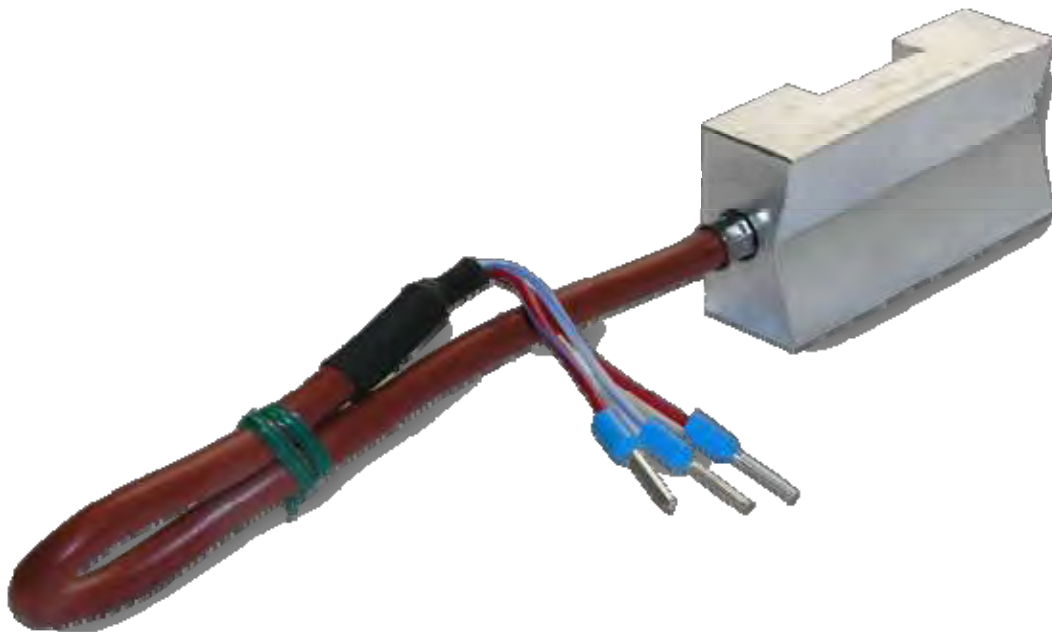

Specifications

Resistance thermometer PT100 to ICE 751, CLASS A or B Available with 2, 3 or 4 wire circuit

Probe length:	50mm
Protection:	IP67
Cable insulation :	Silicon- Teflon (3 x 0,5mm ²)

Other technical characteristics (PT1000, PT500, Ni1000, cable length, insulation cable temperature etc.) available upon request

Temperature Sensors and Special Cables

Series SUR - Surface resistance thermometer and thermocouple ring type
Preferred use for measuring temperatures on round or flat surfaces of closed pipe systems

Measurement insert	Length	Temperature range	Cable length	Ordering Nr.	Price (€)
Fe-Konst.	20mm	from 0 to +400°C	3m	4332E07001	
1 x Pt100	20mm	from -50 to +260°C	3m	433Z61B607	



Specifications

- Pt100 Temperature Sensor IEC 751 Cl.B, 2 or 3 wire and thermocouple Type J to EN 60584
- For temperature from -50°C +400°C
- Quick and easy installation
- Low thermal mass

Protection tube:	Stainless steel 1.4571
Ring dimension:	Φ10x5mm
Cable insulation for thermocouple:	Fiber Glass – Fiber Glass - Braided (2 x 0,22mm ²)
Cable insulation for resistance thermometer:	Teflon – Braided - Teflon (3 x 0,5mm ²)

Temperature Sensors and Special Cables

Series SUR - Film surface resistance thermometer Preferred for temperature measurement of round or flat surfaces

Measurement insert	Sensor Body	Temperature range	Cable length	Ordering Nr.	Price (€)
	W L T				
1 x Pt100	21 50 0.3	from -80 to +180°C	3m	4332E07001	
1 x Pt100	21 50 0.3	from -80 to +180°C	5m	433Z61B607	

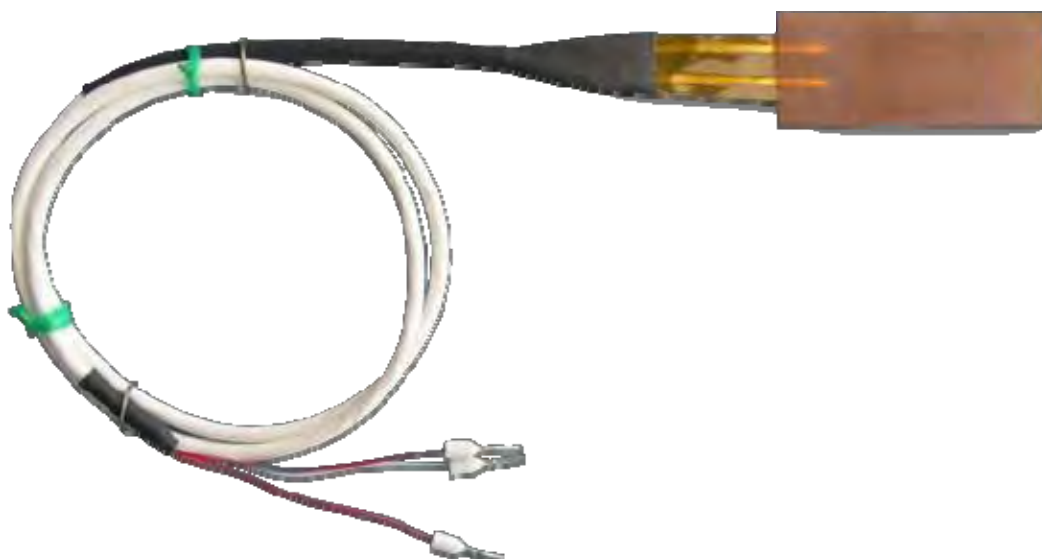

Specifications

Resistance type and tolerances:	Resistance thermometers Pt100, Class B $\pm(0,30K+0,005 \times t)$ Alpha=3.850-10-3/o C, IEC 751 2-3 wire system
Temperature range:	from -80 to +180°C
Sensor body:	21 x 50 x 0.3mm
Cable Insulation:	Teflon – Braided – Teflon (4 x 0.22mm ²)

Other technical characteristics (length, diameter, connector etc.) available upon request

Temperature Sensors and Special Cables

Series SUR - Slot Surface Sensor For temperature measurement on surfaces and is primarily used for temperature measurement in solar installations.

Measurment insert	Temperature range	Cable length	Ordering Nr.	Price (€)
1 x Pt 100	from -20 to +120°C	3m	435Z000100	
1 x Pt1000	from -20 to +120°C	3m	435K000100	



Specifications

Resistance type and tolerance:	Resistance thermometer P+100 or P+1000 class B from $\pm 0,30^{\circ}\text{C}$ to 0°C (IEC 751), 2 or 3 system wire system
Cable Insulation:	Polypropylene ($2 \times 0,22\text{mm}^2$)
Temperature range:	from -20 to 120°C
Protection mode:	IP65

Other technical characteristics (length, diameter, connector etc.) available upon request

Temperature Sensors and Special Cables

Series THR - Heavy-Duty Industrial Thermocouple Wire Shielded Extension Cables up to 703° C

Measurement insert	Temperature range	Cable length	Ordering Nr.	Price (€)
1 x K	up to 703° C	5m	44742AB003	
1 x K	up to 703° C	7m	44742AB009	
1 x K	up to 703° C	11m	44742AB016	



Specifications

Temperature measurement on Aluminum Solid round Bar for temperature monitoring in the core of the bar, in order to avoid temperature over 580°C

Conductors:	20 AWG solid special limits thermocouple typ K per ASTM E 230
Insulation:	Nominal .012" wall braided 703°C <ul style="list-style-type: none"> • Fiberglass with silicone • Impregnation color coded • Positive (KKP)-yellow • Negative (KK)-red
Construction:	two conductors twisted
Covering :	spirally wrapped half-oval galvanized steel nominal OD=.136"

Other technical characteristics (length, diameter, connector etc.) available upon request

Temperature Sensors and Special Cables

Series CBW - Thermocouple temperature sensor with cable and single protection tube. Preferred for measuring temperature exhaust system. Excellent vibration proof and shock proof.

Measurement insert	Diameter	Probe length	Cable length	Ordering Nr.	Price (€)
1 x K	9.5m	186mm	3m	4274ZBB017	
1 x K	9.5m	236mm	3m	4274ZGB002	
1 x K	9.5m	286mm	3m	4274ZEB009	
1 x K	9.5m	316mm	3m	4274ZEB009	

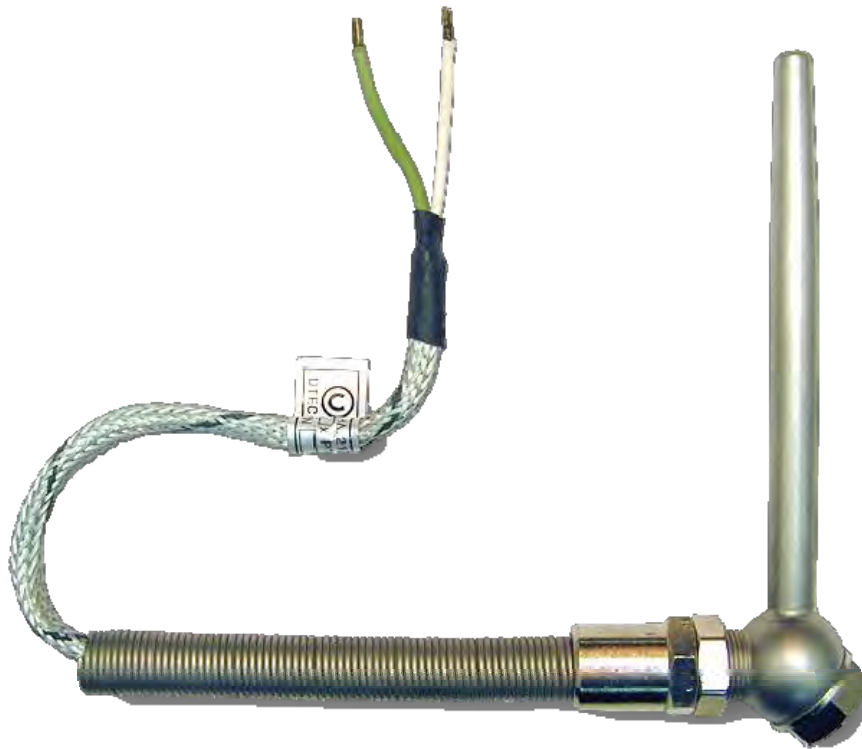

Specifications

The measuring insert is fitted with thermocouple to type K IEC 584

Temperature Sensors and Special Cables

Tube Diameter:	9.5mm
Probe Length:	186mm, 236 mm, 286 mm, 316 mm
Protection:	IP67
Temperature:	from 0 to -800°C
Compensating cable:	Silicone-Fiberglass-Braiding

Other technical characteristics (length, diameter, connector etc.) available upon request

Temperature Sensors and Special Cables

Series CBWR- Angle thermocouple temperature sensor with cable and single protection tube.

Preferred for measuring temperature, mainly on ships in connection with diesel engines in exhaust system

Measurement insert	Diameter	Probe length	Process Connection	Cable length	Ordering Nr.	Price (€)
2xK	12/10mm	110mm	M24x1.5Fem	0.8m	4285I9BR01	
2xK	12/10mm	110mm	M24x1.5Fem	1.5m	4285I9BR05	
2xK	12/10mm	110mm	M24x1.5Fem	2.6m	4285I9BR01	



Specifications

The measuring insert is fitted with Thermocouple (mineral insulated cable) to type K (double)IEC 584-2 Class 2 .

Tube diameter :	12/10mm
Probe Length :	110mm
Process Connection:	½ BSP
Process connection:	M24x1.5Fem
Material :	AISI 316L made from solid bar stock
Compensating cable:	Fiberglass-Fiberglass-Braiding with covered eith stainless steel flexible armour
Termination:	6 pole female connector (jaeger)
Temperature range:	0-800°C

Other technical characteristics (length, diameter, connectors , etc.) available upon request

Temperature Sensors and Special Cables

Series CBR- Resistance thermometer with connection cable and single protection tube excellent vibration proof and shockproof performances at high temperature, preferred for measuring temperature exhaust system.

Measurement insert	Diameter	Probe length	Cable length	Ordering Nr.	Price (€)
1 x Pt100	12mm	105mm	5m	426ZI8B408	



Specifications

The measuring insert is fitted with resistance thermometer PT100 to EN 60751, Class B to IEC 751, with 3 wire system .

Tube diameter :	12mm
Probe Length :	105mm
Process Connection:	½ BSP
Protection tube:	stainless steel 1.4571
Protection :	IP67
Cable insulation:	Teflon-braiding- Teflon (4x0.5mm ²)

Other technical characteristics (length, diameter, connector etc.) available upon request

Temperature Sensors and Special Cables

Series MIC – Flexible mineral insulated thermometer (type Mantel).
Preferred for temperature measurement of temperatures in pipe and tank systems e.g. in oil tankers, or part of a volume measuring system.

Measurement insert	Diameter	Length	Cable length	Ordering Nr.	Price (€)
1 x Pt100	3mm	2000mm	0.5m	3881038523	
1 x Pt100	3mm	4000mm	0.5m	3881038522	
1 x Pt100	3mm	6000mm	0.5m	3881038003	
1 x Pt100	3mm	8000mm	0.5m	3881038004	
1 x Pt100	3mm	9000mm	0.5m	3881038005	
1 x Pt100	3mm	10000mm	0.5m	3881038017	
1 x Pt100	3mm	12000mm	0.5m	3881038022	
1 x Pt100	3mm	14000mm	0.5m	3881038670	
1 x Pt100	3mm	15000mm	0.5m	3881038018	
1 x Pt100	3mm	17000mm	0.5m	3881038019	
1 x Pt100	3mm	20000mm	0.5m	388103A566	
1 x Pt100	3mm	22000mm	0.5m	3881038021	
1 x Pt100	3mm	25000mm	0.5m	3881038020	
1 x Pt100	3mm	27000mm	0.5m	3881038019	
1 x Pt100	3mm	31000mm	0.5m	3881038006	



Specifications

Resistance thermometer Pt100 Class A $\pm 0,15$ at 0°C acc. To IEC 751 3wire or 4wire system

Probe Diameter:	3mm, 4.5mm
Process Connection :	1/8 BSP (male) adjustable
Response Time:	(main values) measured at velocities in water 0.4m/s t 0.5=11sec
Sheath Material:	AISI 316
Connecting Cable:	Teflon: ambient temp. -50°C to +260°C

Other technical characteristics (length, diameter, connector etc.) available upon request

Temperature Sensors and Special Cables

Series MIC - Mineral insulated thermocouple (type Mantel) Preferred for temperature measurement of liquids and gases on solids such as hot plates and welding jaws. Application include heating installations, ovens, plant engineering and laboratories.

Measurment insert	Diameter	Length	Cable length	Temp _r	Ordering Nr.	Price (€)
1 x J	1.5mm	110mm	3m	800°C	3881014063	
1 x K	1.5mm	150mm	1.5m	1100°C	3881084040	
1 x J	2mm	80mm	1.5m	800°C	3881016043	
1 x J	1mm	150mm	2m	800°C	38810Z3072	

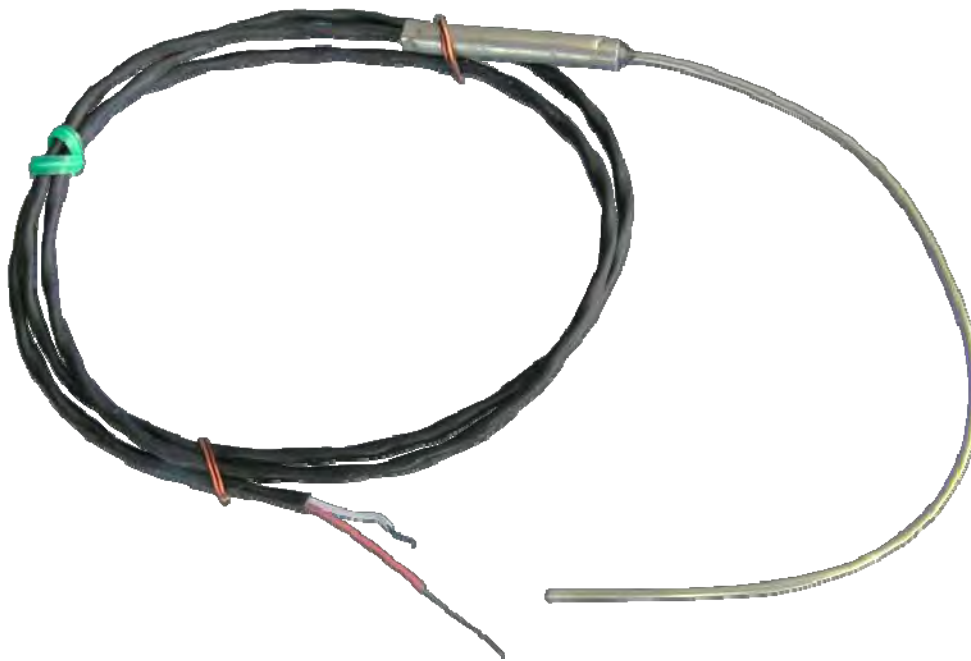

Specifications

Resistance thermometer Pt100 Class A $\pm 0,15$ at 0°C acc. To IEC 751 3wire or 4wire system

Probe Diameter:	3mm, 4.5mm
Process Connection :	1/8 BSP (male) adjustable
Response Time:	(main values) measured at velocities in water 0.4m/s t 0.5=11sec
Sheath Material:	AISI 316
Connecting Cable:	Teflon: ambient temp. -50°C to +260°C

Other technical characteristics (length, diameter, connector etc.) available upon request

Temperature Sensors and Special Cables

Series CON – Mineral Insulated thermocouples with standard male connector, are used in chemical plant, power stations, pipelines in engine construction and on test beds.

Measurment insert	Diameter	Length	Material	Temperature	Ordering Nr.	Price (€)
1 x Nicr-Ni	2,0mm	250mm	INCONEL 600	1150°C	43743GE001	
1 x Nicr-Ni	3,0mm	250mm	INCONEL 600	1150°C	43744GE001	
1 x Nicr-Ni	4,5mm	250mm	INCONEL 600	1150°C	43747GE001	
1 x Nicr-Ni	6,0mm	250mm	INCONEL 600	1150°C	4374AGE001	
1 x Nicr-Ni	8,0mm	500mm	INCONEL 600	1150°C	4374EIE001	
1 x Fe-Konst	2,0mm	250mm	AISI 316	0-800°C	43723GB001	
1 x Fe-Konst	3,0mm	250mm	AISI 316	0-800°C	43724GB001	
1 x Fe-Konst	4,5mm	250mm	AISI 316	0-800°C	43727GB001	
1 x Nicrosil-Nisil	3,0mm	250mm	NIMONIC	0-1200°C	437C4GU001	
1 x Nicrosil-Nisil	6,0mm	500mm	NIMONIC	0-1200°C	437CAIU001	



Specifications

- The thermocouples are normally insulated from the sheath,
- The measuring insert is fitted with thermocouple to IEC 584
- Versions with two thermocouples are also available.
- Test pressure: 40 bar (helium/leakage test at the measurement point)

Probe diameter:	2mm ,3mm, 4.5mm,6mm 8mm
Sheath material:	AISI 316, Inconell 600, or Nimonic
Probe length:	250mm, 500mm
Connection:	Compensated male standard connector with body in molded Nylon according to STM E 1129/E 1129M-91 T° Max.120° C
Temp. range:	-200 to +1200 ° C

Other technical characteristics (length, diameter, connector etc.) available upon request

Temperature Sensors and Special Cables

Series INS - Food temperature Insertion Resistance Thermometer
 Particularly suitable for cooking and baking processes in all areas of food processing and preservation.

Measurement insert	Diameter	Length	Cable length	Temperature range	Ordering Nr.	Price (€)
1 x Pt100	4mm	150mm	4m	-50 +260°C	449Z6AB023	
1 x Pt100	4mm	150mm	5m	-50 +260°C	449Z6AB017	
1 x Pt100	4mm	150mm	3m	-50 +260°C	449Z6AB024	
1 x Pt1000	4mm	150mm	4m	-50 +260°C	449K6AB003	



Specifications

Resistance type and tolerances:	Resistance thermometer Pt100 ,class A, (single or twin) accuracy $\pm 0,15^{\circ}\text{C}$ to 0°C , IEC751 3,4 or 6wire circuit
Outside diam.:	4mm (oblique or angled at 45o)
Sheath material :	St.St.1.4571
Probe length:	150mm
Connecting cable:	Teflon (PTFE) - Braiding - Teflon
Protection :	IP67
Temp. range:	-50°C +260°C

Page 50 **Other technical characteristics (length, diameter, connector etc.) available upon request**

Temperature Sensors and Special Cables

Series INS - Food temperature Insertion Resistance Thermometers are particularly suitable for cooking and baking processes in all areas of food processing and preservation with stainless steel flexible tube.

Measurment insert	Diameter	Length	Cable length	Temperature range	Ordering Nr.	Price (€)
1 x Pt100	4mm	150mm	4m	-50+260° C	449Z6AB003	
1 x Pt100	4mm	150mm	3m	-50+260° C	449Z6AB009	
1 x Pt100	4mm	150mm	5m	-50+260° C	449Z6AB016	
2 x Pt100	4mm	150mm	3m	-50+260° C	449H6AB006	

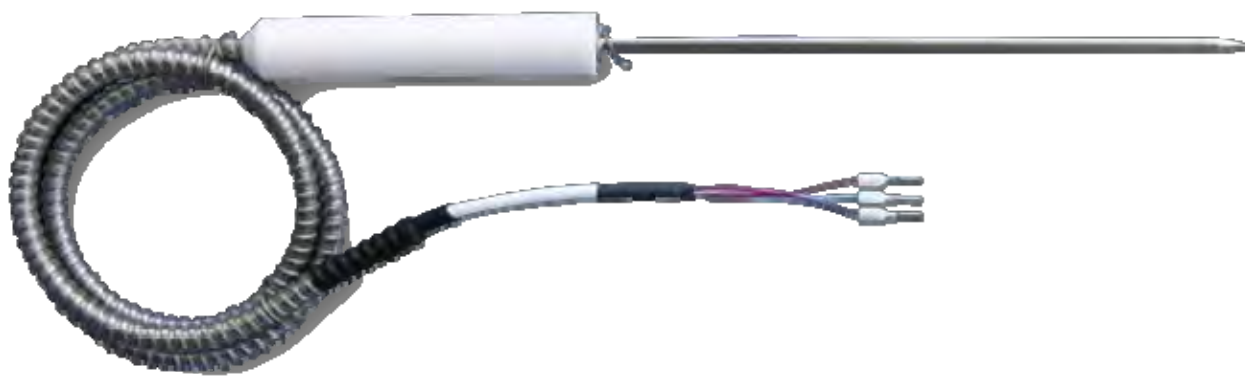

Specifications

Resistance type and tolerances:	Resistance thermometer Pt100 ,class A,(single or twin) accuracy $\pm 0,15^{\circ}\text{C}$ to 0°C , IEC751 3,4 or 6wire circuit
Outside diam.:	4mm (oblique or angled at 45°)
Sheath material :	St.St.1.4571
Probe length:	150mm
Connecting cable:	Teflon (PTFE)-Braiding—Teflon and stainless steel flexible tube
Protection :	IP67
Temp. range:	-50+260° C

Other technical characteristics (length, diameter, connector etc.) available upon request

Temperature Sensors and Special Cables

Series PRT - Portable temperature sensor type K (NIR-NI) Suitable for measurement in gases, fluids and liquids.

Measurment insert	Diameter	Length	Cable length	Ordering Nr.	Price (€)
1 x K	3mm	400mm	2m	43944HE005	



Specifications

Measuring temperature:	from -200°C up to +1150°C
Thermocouple type:	(NIR-NI) type K
Accuracy:	class1
Hand ; grip material:	PVC suitable up to 90°C
Length:	100mm
Pocket material:	inconel 11600
Mini thermocouple plug:	(NIR-NI)
Length:	300mm,400mm,600mm
Diameter:	3mm

Suitable for connection with UTECO's portable thermometers.

Other technical characteristics (length, diameter, connector etc.) available upon request

Temperature Sensors and Special Cables

Series PRT - High temperature handheld probes for bigieta (solid bar) surface measurement. For temperature from 0 to 1260°C Type K (NICR-NI) measures hot metal surfaces. Especially designed for heavy duty.

Measurement insert	Diameter	Length	Cable length	Ordering Nr.	Price (€)
1 x K	50mm	150mm	2m	4394XA9001	



Specifications

Specifically designed for use where surface temperatures reach at to 1260°C and rough handling is routine UTECO's foundry probe uses large, heavy duty tips that can penetrate surface slag to measure the true temperature of the casting.

The surface to be measured must be electrically conductive.

The lead wires are 16-AVG stranded wire with high temperature insulation and stainless steel overbraiding for added protection length 760mm

Suitable for connection with UTECO's portable thermometers.

Temperature Sensors and Special Cables

Head mounted 2-wire transmitter d TRANS T03 B PT100 - 4-20mA.

Type	Ordering Nr.	Price (€)
d TRANS T03 B	3201200006	
Fixing bracket for mounting	3201200013	



Specifications

Analog 2-wire transmitter with digital adjustment for installation in terminal head Form B

Input:	Pt100, 3-wire
Output:	4-20 mA
Range:	0 to +100°C(programmable)
Supply:	7.5 - 30V DC

Accessories

- PC setup program, multilingual
- PC interface (electrically isolated) with TTL/RS232 converter, power supply (230V AC) and adapter (socket)
- PC interface (electrically isolated) with TTL/RS232 converter, power supply (115V AC) and

Temperature Sensors and Special Cables

- adapter (socket)
- supply units 1-way and 4-way (Data Sheet 70.7500)
- isolating amplifier and supply isolator (Data Sheet 70.7510)
- supply unit for transmitters (Data Sheet 70.7520)

Other technical characteristics (length, diameter, connector etc.) available upon request

Temperature Sensors and Special Cables

Head mounted transmitter d TRANS T03 BU PT100 - from 0 to 10V 3-wire Temperature Transmitter for Head-Mounting

Type	Ordering Nr.	Price (€)
d TRANS T03 BU	3201200011	
Fixing bracket for mounting	3201200013	



Specifications

Analog 3-wire transmitter with digital adjustment for installation in terminal head Form B

Input:	Pt100, 3-wire
Output:	0-10V
Range:	0 to +100°C (adjustable)
Supply:	7.5-30V DC

Accessories

- PC setup program, multilingual
- PC interface (electrically isolated) with TTL/RS232 converter, power supply (230V AC) and adapter (socket)
- PC interface (electrically isolated) with TTL/RS232 converter, power supply (115V AC) and adapter (socket)
- supply units 1-way and 4-way (Data Sheet 70.7500)
- isolating amplifier and supply isolator (Data Sheet 70.7510)
- supply unit for transmitters (Data Sheet 70.7520)

Temperature Sensors and Special Cables

Head mounted transmitter APAQ-HCF T/C for thermocouple input, 4-20mA output.

Input	Adjustments	Temperature	Output	Mounting	Ordering Nr.	Price (€)
Thermocouple Type J, L, T, K and N	0 to 50 mV	-40 to +85°C	4-20 mA	DIN B-head or larger	3941202040	



Specifications

Input:	Thermocouples selectable: type J, L, T, K and N with ranges within -5 to +55 mV
Input:	impedance: >5 MΩ
Input:	Max. sensor wire resistance: 500 Ω (total loop)
Monitoring:	Sensor break detection, selectable: Upscale ~25 mA, downscale ~3 mA
Adjustments:	Span, selectable: 10 to 50 mV
Adjustments:	Span, fine adjustment: ±10 %
Output:	Current: 4 - 20 mA
Output:	Current limitation: ~ 25 mA
Output:	Permissible load: 700 Ω @ 24 VDC, 25 mA
Temperature: Ambient, operating:	-40°C to +85° C
Response time 10-90%:	≤ 0.2 s
Power supply voltage:	6.5 to 32 VDC (polarity protected)
Permissible ripple:	4 Vp-p @ 50/60 Hz
Linearity (mA output to mV input):	±0.1 % of mV span
Calibration	±0.1 % of span
Material / Flammability(UL):	Zinc alloy + ABS / V0
Mounting:	DIN B-head or larger

Temperature Sensors and Special Cables

Connection, single/stranded wires :	≤2.5 mm ² , AWG 14
Protection, housing with cover/terminals:	IP 20 / IP 10

Temperature Sensors and Special Cables

DIN Rail transmitter d trans T03T PT100, 4-20mA output

Type	Ordering Nr.	Price (€)
d trans T03T PT100	1200102301	



Specifications

Transmitters T03T are designed for industrial applications, used to measure temperatures through Pt100 resistance thermometers in 2-/3-wire circuit connections. Output 4-20mA is linear with temperature calibration / configuration of the transmitter from a PC using Jumo's setup program for adjustable / configurable parameters. It features fine calibration / adjustment of the output signal of a transmitter.

Input:	Pt100 (EN 60751) from -200°C to +850°C
Analogue output:	4-20mA
Supply voltage:	7,5 – 30 V DC
Calibration / configuration accuracy:	≤ ±0,2% or ≤ ±0,2°C

Accessories

- PC setup program, multilingual
- PC interface (electrically isolated) with TTL/RS232 converter, power supply (230V AC) and adapter (socket)
- PC interface (electrically isolated) with TTL/RS232 converter, power supply (115V AC) and

Temperature Sensors and Special Cables

DIN Rail transmitter d trans T03T PT100, 4-20mA output

Type	Ordering Nr.	Price (€)
APAQ-LR	3941200000	



Specifications

Input:	Pt100 3-wire connection
Sensor Failure	upscale, downscale
Fine adjustment:	± 10%
Zero:	from -50°C to +50°C (from -60°F to +120°F)
Output:	4-20 MA
Operating temperature:	from -20°C to +70°C
Galvanic isolation:	NO
Power supply:	from 6,5 to 32VDC
Typical accuracy:	± 0,15% of temperature span
Input:	Pt100 3-wire connection

Temperature Sensors and Special Cables

DIN Rail 2-wire transmitter APAQ-LC T/C for thermocouples, 4-20mA output

Type	Ordering Nr.	Price (€)
APAQ-LC	3941200002	



Specifications

Input:	T/C J,L,T,K,N
Sensor Failure	upscale, downscale
Span:	from 10 to 50MV continuously
Fine adjustment:	± 10%
Output:	4-20 MA
Operating temperature:	from -20°C to +70°C
Galvanic isolation	NO
Power supply:	from 6,5 to 32VDC
Typical accuracy:	±0,5% to ±1,0% of temperature span

Temperature Sensors and Special Cables

DIN Rail universal-programmable transmitter d TRANS T02 PCP

Type	Ordering Nr.	Price (€)
d TRANS T02 PCP	1200102280	



Specifications

The dTRANS T02 PCP is a digital 4-wire transmitter/signal conditioner with isolation of the standard signal, custom linearization, 2 alarms, 2 LEDs and fine adjustment with 2 push buttons or the setup program. Features **excellent long-term stability** and **probe break and short circuit detection**. Utilization of setup software allows true **online communication** with display of actual value.

Input:	TC, RTD, voltage, current, resistance transmitter, potentiometer
Analog Output:	0-20mA or 4-20mA or 0-10V or 2-10V
Digital Output:	alarm: 2 open-collector outputs
	switching capacity: 35V, 100mA
Supply:	20-53V AC/DC or 110-240V AC

Accessories

- Setup program, multilingual 70/00378730
- PC interface with TTL/RS232 converter and adapter (socket) 70/00350260
- PC interface with USB/TTL converter, adapter (socket) and adapter (pins) 70/00456352

Temperature Sensors and Special Cables

Series TWT - Screw-in pocket for systems where drain- or pressure- less installations / exchanging of thermocouples or resistance thermometers are required.

Process Connection	Stem Diameter	Bore Diameter	Immersion Length	Material	Ordering Nr.	Price (€)
½ m. - ½ f. BSP	12mm	9mm	100mm	1.4571	4600I8B402	
½ m. - ½ f. BSP	10mm	7mm	100mm	1.4571	4600H8B401	
½ m. - ½ f. BSP	8mm	6mm	100mm	1.4571	4600E8B401	
¾ m. - ¾ f. BSP	15mm	12mm	100mm	1.4571	4600M8B501	



Specifications

pockets in different materials:	steel 1.0305, stainless steel 1.4571, steel 1.7335
operating pressure :	up to 450 bar
Immersion Length:	100mm
Outside diameter:	8mm,10mm,12mm,15mm
Process Connection:	R ½ BSP, ¾ BSP or NPT
Temperature range:	up to 800°C

Other technical characteristics (length, diameter, connector etc.) available upon request

Temperature Sensors and Special Cables

Series TWF- Flanged bar stock thermowells with tapered stem

Stem Diameter under flange	Tip Diameter	Bore Diameter	Immersion Length	Material	Ordering Nr.	Price (€)
22mm	19mm	7mm	300mm	AISI316L	4510STHBP01	

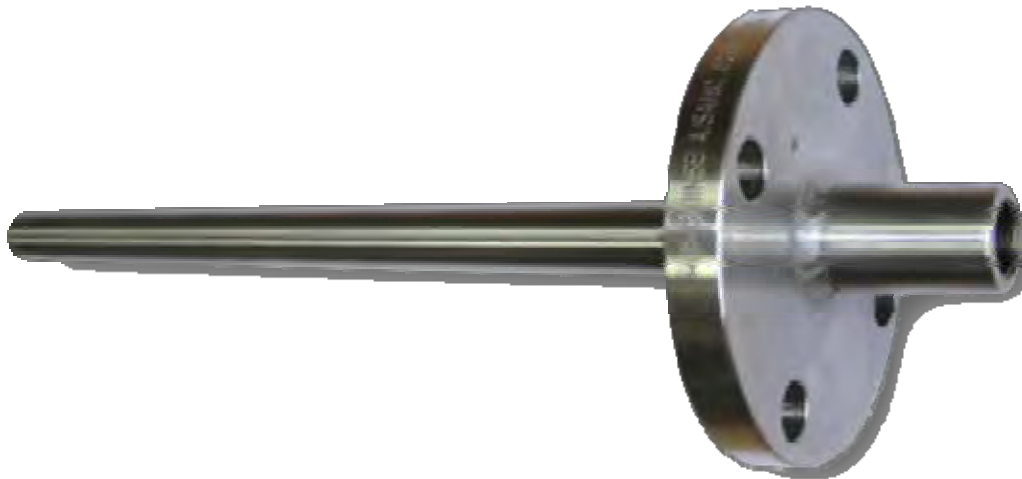

Specifications

Thermowells are used for installing thermocouples resistance thermometers, whenever replacement without draining the system and/or pressure resistance are required

Type:	tapered, from bar stock, flanged welded on both sides to thermowell (un-machined)
Material:	SS 316 or 304
Bar stock diameter:	32mm
Surface finish:	1µm(40RU)
Eccentricity:	10% of wall thickness max
Tip thickness:	4mm
Flange Size / Internal Thread	1-1/2" 300 RF / ½ NPT

Test wells can be supplied with st.st plug and chain. Please specify when ordering

- Documentation and test
- Construction drawing
- Hydrostatic test Pressure
- Dye penetrant test
- Inspection and material certificate according to EN10204 3.1.B,3.1C
- Welding procedure specification (WP.5)
- Procedure Qualification Record (PQR)
- Certificate according to NACE MR.01.75
- Tensile test, impact test
- Heat treatment certificate
- HUEY test to ASTM A 262-C
- Performance test to ASME PTC 19.3-1974

Other technical characteristics (length, diameter, Process connection, material etc.) available upon request

Temperature Sensors and Special Cables

Miniature Connector with thermocouple material contacts

Type	Contacts	color	Ordering Nr.	Price (€)
Iron / Const.(J)	Plug	Black	3831622864	
Iron / Const.(J)	Jack	Black	3831622865	
Chrome / Alumer(K)	Plug	Green	3831632826	
Chrome / Alumer(K)	Jack	Green	3831632174	
Copper / Const.(T)	Plug	Blue	3831642836	
Copper / Const.(T)	Jack	Blue	3831642137	
PtRh / Pt(S,R)	Plug	Green	3831652852	
PtRh / Pt(S,R)	Jack	Green	3831652153	
Chrome / Const.(E)	Plug	Violet	3831672169	
Chrome / Const.(E)	Jack	Violet	3831672870	
Nicrosil / Nisil(N)	Plug	Orange	3831682964	
Nicrosil / Nisil(N)	Jack	Orange	3831682965	



Specifications

Thermowells are used for installing thermocouples resistance thermometers, whenever replacement without draining the system and/or pressure resistance are required

Body material:	Tough, self-extinguishing thermoplastic compound with low moisture absorption rate and good dielectric strength
Maximum cable diameter:	min. 0,12mm, max. 0,8mm
Wire terminals:	screw type for quick wiring , 5mm
Maximum temperature rating:	200°C

Temperature Sensors and Special Cables

Standard Connector with thermocouple material contacts

Type	Contacts	color	Ordering Nr.	Price (€)
Iron / Const.	Plug	Black	3831612920	
Iron / Const.	Jack	Black	3831622281	
Chrome / Alumer	Plug	Yellow	3831632933	
Chrome / Alumer	Jack	Yellow	3831632235	
Copper / Const.	Plug	Blue	3831652000	
Copper / Const.	Jack	Blue	3831652001	
PtRh / Pt	Plug	Green	3831652941	
PtRh / Pt	Jack	Green	3831652250	
Nicrosil / Nisil	Plug	Orange	3831682962	
Nicrosil / Nisil	Jack	Orange	3831682963	



Specifications

Thermowells are used for installing thermocouples resistance thermometers, whenever replacement without draining the system and/or pressure resistance are required

Body material:	Tough, self-extinguishing thermoplastic compound with low moisture absorption rate and good dielectric strength
Maximum cable diameter:	1.6mm
Wire terminals:	6.4mm
Maximum temperature rating:	200°C

Temperature Sensors and Special Cables

Standard panel with Thermocouple material contacts

Type	color	Ordering Nr.	Price (€)
Iron / Constantan(J)	Black	3831622368	
Chrome1 / Alume1(K)	Black	3831632382	
PtRh / Pt(S,R)	Green	3831652340	
NICROSIL / NiSil(N)	Orange	3831682361	



Specifications

Thermowells are used for installing thermocouples resistance thermometers, whenever replacement without draining the system and/or pressure resistance are required

Front panel:	anodized aluminum 2,4mm thick
Panel dimensions:	38x38mm
Panel cut out:	square or round 30mm
Depth behind panel:	20mm
Maximum temperature rating:	200°C
Maximum conductor dimension:	1.6mm

Temperature Sensors and Special Cables

Series Conductive - Level sensors for conductive limit value detection

Diam. rod	Length	Process Connection	Number rod electrode	Ordering Nr.	Price (€)
4mm	500mm	R ½ BSP	1	44206IB402	
4mm	1000mm	R 1 ½ BSP	2	44206PB702	
4mm	1000mm	R 1 ½ BSP	3	44206PB701	
4mm	1000mm	R 1 ½ BSP	4	44206PB704	

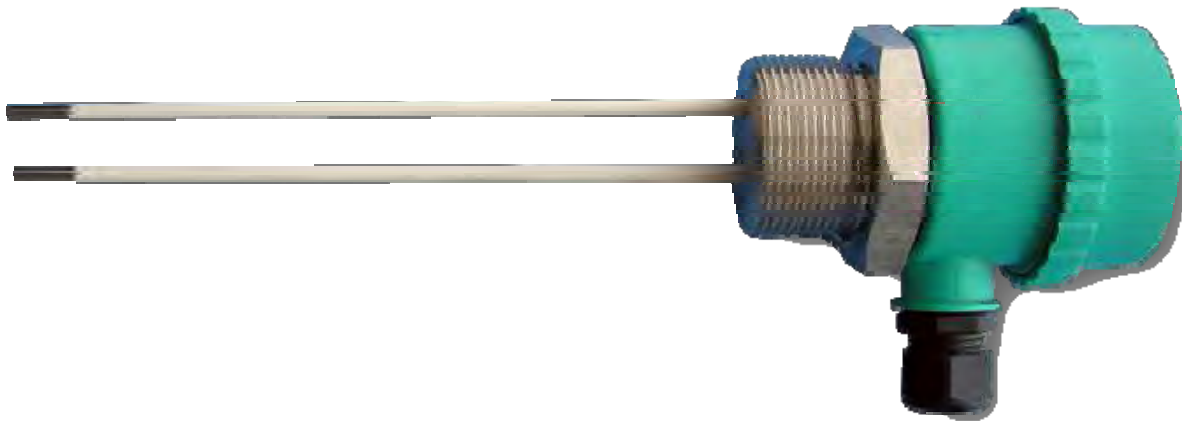

Specifications

Material:	st. st. 14571
Diameter rod:	4mm
Process connection:	R ½ or 1 ½ BSP
Insulation rod electrode:	PFA or PVC
Temperature range:	from 0° C to 200° C
Length rod electrode:	500 – 1000mm
Number of electrode:	1,2,3,4 or 5 electrode
Terminal box:	Form B, IP65, aluminum die-casting or plastic IP65

Other technical characteristics (length, number of electrodes, connections etc.) available upon request

Electronic units – amplifiers available upon request

Temperature Sensors and Special Cables

Series Conductive - Level sensors for conductive limit value detection

Diam. rod	Length	Process Connection	Number rod electrode	Ordering Nr.	Price (€)
4mm	1000mm	R ¼ BSP	1	44206PB101	
4mm	500mm	R ¼ BSP	1	44206IB101	

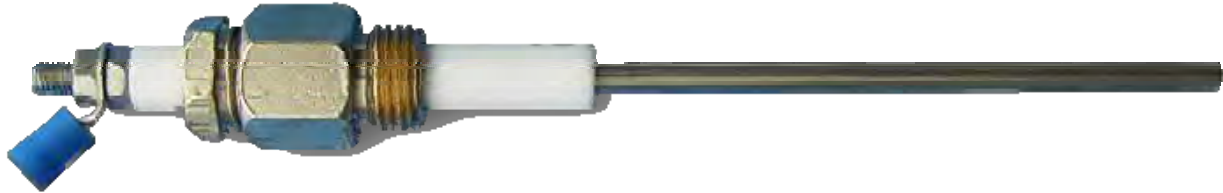

Specifications

Material:	stainless steel 14571
Diameter rod:	4 mm
Process connection:	R ¼ BSP
Insulation rod electrode:	PFA
Temperature range:	from 0° C to 260° C

Electronic units – amplifiers available upon request

Special Cables section



Special Cables

Temperature Sensors and Special Cables

Instrumentation & Bus Cables

Code: 1-52-50-01-00-5

Type: RE-2Y(St)Y-fl 300 V 2x2x1,0 mm² Black

Insulation: PVC/OS/PVC

Resistance to temperature: up to 70°C

External diameter: 8,2 mm



Code: 1-52-50-02-00-9

Type: RE-Y(St)YSWAY-fl 300V 2X2X1,0 mm² Grey

Insulation: PVC/OS/PVC/SWA/PVC

Resistance to temperature: up to 70°C

External diameter: 15,00 mm



Code: 1-52-50-06-01-1

Type: RE-Yw(St)YwSWAYw-fl 300V 1X2X1,5 mm²

Insulation: PVC/OS/PVC/SWA/PVC

Resistance to temperature: up to 105°C

External diameter: 12,4 mm



Code: 1-51-50-02-00-0

Type: RE-2Y(ST)Y-PIMF 2x2x0,5 mm² Blue

Insulation: PVC/OS/IS/PVC

Resistance to temperature: up to 70°C

External diameter: 11,2 mm



Code: 1-51-50-08-02-6

Type: RE-2G(St)HSWAY-fl CI 500V 5x2x0,75 mm²

Insulation: Silicon Rubber/OS/LSZH/SWA/PVC

Resistance to temperature: up to 90°C

External diameter: 18,1 mm

Standard: IEC 60331 Fire Resisting (CI)



Code: 1-51-50-06-00-0

Type: PROFIBUS FMS/DP 1x2xAWG 22/1

Conductor: solid conductors

Resistance to temperature: up to 70°C

External diameter: 7,9 mm



Code: 1-00-50-06-00-1

Type: Profibus L2 7-wire 1x2x0,64

Conductor: 7 strand

Resistance to temperature: up to 70°C

External diameter: 7,3 mm



Code: 1-98-50-21-00-9

Type: CC-LINK BU 3x0,5 (AWG20/7)

Conductor: 7 strand

Resistance to temperature: up to 70°C

External diameter: 7,9 mm



Temperature Sensors and Special Cables

Data & Control Cables

Code: 1-50-50-09-51-0
Type: OZ-J 4X1,5 mm²
Insulation: PVC - PVC
Resistance to temperature: up to 70°C
External diameter: 7,1 mm



Code: 1-50-50-15-98-4
Type: LIYCY 7X1,0 mm²
Insulation: PVC – Braid - PVC
Resistance to temperature: up to 70°C
External diameter: 7,9 mm



Code: 1-50-50-13-15-0
Type: OZCuY-J 7X1,0 mm²
Insulation: PVC – PVC - Braid - PVC
Resistance to temperature: up to 70°C
External diameter : 11,6mm



Code: 1-50-50-17-09-0
Type: NYMH11YO-J (YPUR) 3X1,5 mm²
Insulation : Polyurethane - Polyurethane
Resistance to temperature: up to 70°C
External diameter: 7,9 mm
Very good chemical resistance



Code: 1-50-50-18-12-0
Type: S 200 3x0,75
Insulation: TPE-E - PUR
Resistance to temperature: up to 70°C
External diameter: 7,9 mm
Very good chemical resistance
Highly flexible for continues bending motions



Code: 1-50-50-22-05-0
Type: S 90 C 4x1,5 mm²
Insulation: PVC - braid - PUR
Resistance to temperature: up to 70°C
External diameter: 11,8 mm
Very good chemical resistance
Highly flexible for continues bending motions +braid



Code: 1-50-50-22-01-0
Type: ZKBi 1,0 mm² Y.T. 20 KV
Insulation: Silicone – Fiber glass- Silicone
Resistance to temperature: up to 180°C
External diameter: 8,0 mm
20 KV High Voltage cable



Temperature Sensors and Special Cables

Compensating & extension cables

Code: 1-50-50-23-01-0
Type: AN 11 LR 2X1,5 mm²
For thermocouple : Type K NiCr-Ni
Color code: Acc to IEC 584
Insulation: Silicone – Fiberglass-Braid
Resistance to temperature: up to 180°C
External diameter: 6,2 mm



Code: 1-50-50-23-02-0
Type: AN 11-4LR 4x1,50
For thermocouple: Type K NiCr-Ni
Color code: Acc to IEC 584
Insulation: Silicone – Silicone - Braid
Resistance to temperature: up to 180°C
External diameter: 9,3 mm



Code: 1-00-50-23-03-4
Type: 2X1,3 mm² PVC-PVC (flat)
For thermocouple: Type K NiCr-Ni
Color code: Acc to DIN 43710
Insulation : PVC - PVC
Resistance to temperature : up to 70°C
External diameter : 6,7 mm



Code: 1-00-50-23-08-0
Type: 2X0,22 mm PVC-PVC (Round)
For thermocouple: Type K NiCr-Ni
Color code: Acc to IEC 584
Insulation: PVC - PVC
Resistance to temperature: up to 70°C
External diameter: 4,0 mm



Code: 1-00-50-25-01-0
Type: JX 2X0,5 Fiber-Fiber-Braid
For thermocouple: Type J Fe-CuNi
Color code: Acc to IEC 584
Insulation: Fiber – Fiber - Braid
Resistance to temperature: up to 400°C
External diameter: 4,0 mm



Code: 1-83-50-23-09-0
Type: G/G-24-KK (G3 NICR-NI) 2x0,5
For thermocouple: Type K NiCr-Ni
Color code: Acc to ANSI MC 96.1
Insulation: Fiber - Fiber
Resistance to temperature: up to 400°C
External diameter: 2,0 mm



Code: 1-00-50-03-04-6
Type: RT-Y(St)YSWAY-fl 1x2x1,29 mm NiCr-Ni
For thermocouple: Type K NiCr-Ni
Color code: Acc to ANSI MC 96.1
Insulation: PVC–Aluminum foil -Steel Wire Armor-PVC
Resistance to temperature : up to 70°C
External diameter: 13,1mm



Code: 1-00-50-24-04-0
Type: SX PVC-SCH-PVC 16x2x0,50 mm²
For thermocouple: Type S PtRh10-Pt
Color code: Acc to DIN 43710
Insulation: PVC – Aluminum foil - PVC
Resistance to temperature : up to 70°C
External diameter : 19,2 mm



Temperature Sensors and Special Cables

High Temperature Cables

Code: 1-52-50-02-13-1
Type: SIHF-GLS(GLP) 3X1,5 mm2
Insulation: Silicone-Silicone-Fiberglass-Braid
Resistance to temperature: up to 180°C
External diameter: 8,9 mm
Form: Round



Code: 1-00-50-02-13-0
Type: PFA-SS-PFA 3X1,5 mm2
Insulation: Teflon-Braid-Teflon
Resistance to temperature: up to 260°C
External diameter: 6,0 mm
Form: Round



Code: 1-98-50-02-13-7
Type: Teflon- Fiber-Braid 3XAWG16
Insulation: Teflon- Fiberglass-Braid
Resistance to temperature: up to 260°C
External diameter: 5,0 mm
Form: Round



Code: 1-00-50-00-00-0
Type: VIBRA RV 1.00 STV02 2X1,0 mm
Insulation: Vibraflame – Braid- Vibraflame
Resistance to temperature: -196°C ...+1565°C
External diameter: 7,0 mm
Form: Round



Code: 1-00-50-00-00-5
Type: PT100 3X0,5 FIBER-FIBER-BRAID
Insulation: Fiber – Fiber - Braid
Resistance to temperature: up to 400°C
External diameter: 3,0 mm
Form: Round



Code: 1-00-50-02-14-1
Type: Hyflon-Silicon 4X0,22 mm2
Insulation: Hyflon - Silicone
Resistance to temperature: up to 180°C
External diameter: 4,3 mm
Form: Round







Code: 1-20-50-00-00-4
Type: 62849 4X0,14mm2
Insulation: Teflon – Braid - Teflon
Resistance to temperature : up to 260°C
External diameter: 3,5 mm
Form: Round



Temperature Sepsors and Special

International Color Code for Compensating & Extension Cables

					
	ANSI	DIN	IEC/CEI	BS	NF
JX					
KX					
TX					
NX					
EX					
WX					
VX					
SX/RX					