

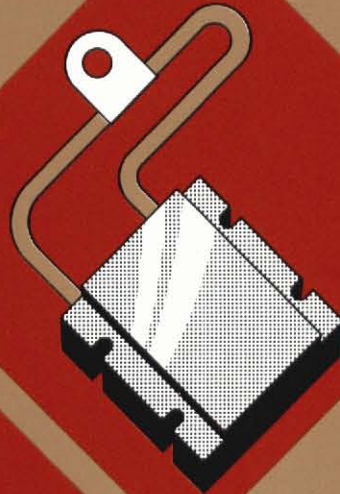

MEGA



KOHLE-SCHLEIFSTÜCKE  
KOHLE-KONTAKTE  
UND KOHLE-ROLLEN  
SLIDING CONTACTS  
FROTTEURS EN CHARBON



## Inhaltsverzeichnis

	Seite
Schleifstücke für Krane und Oberleitungsfahrzeuge, z. B. Obus-Schleifstücke	1 - 6
Plattenförmige Schleifstücke für Stromabnehmer	7 - 14
Plattenförmige Schleifstücke mit Kabel für Stromabnehmer	15 - 17
Dreikant-Schleifstücke für Stromabnehmer	18
Schleifstücke und Kontakte für Kleinschleifleitungen, z. B. Stromschienen, Bagger usw.	19 - 34
Erdungskontakte und Kleinschleifkontakte	35 - 39
Kohlekontakte für Schalter, Schütze und Aufzüge	40 - 49
Kontaktrollen für Regeltrafos und Regelwiderstände	50 - 52

## STROMABNEHMER AUS KOHLE

Hartkohle-Qualitäten      Metallgraphitkohle-Qualitäten      Metallimprägnierte-Qualitäten

Kohleschleifstücke für Stromabnehmer aller Art haben sich durch ihre hervorragenden Eigenschaften auf fast allen Gebieten durchgesetzt und glänzend bewährt. Die früher verwendeten Buntmetallstromabnehmer hatten einen großen mechanischen, sowie elektrischen Verschleiß infolge Lichtbögen, die zu Schmelzperlenbildung führten.

Unsere Qualitäten sind den jeweiligen Anforderungen angepaßt, insbesondere hinsichtlich der Abnutzung der Kohle und äußerster Schonung des Fahrdrabtes, welcher bei Verwendung von Kohleschleifstücken mit einem graphitreichen Schutzfilm überzogen wird und die Reibung und damit die Abnutzung wesentlich mildert.

Infolge dieser glatten Gleitflächen werden Lichtbögen und Rundfunkstörungen vermieden.

Unsere Kohleschleifstücke sind mit einem wasserabweisenden Mittel imprägniert, um die schädlichen Einflüsse von Feuchtigkeit auszuschalten, bei Einsatz im Freien.

Durch Niederschläge, mitgeführte Verunreinigungen oder salzhaltige Luft, werden auf dem Stromabnehmer chemische Reaktionen frei, die sich schädlich auswirken.

Der Anpreßdruck variiert entsprechend dem jeweiligen Verwendungszweck, z. B. Kranbahnen, Grubenbahnen, O-Busse, S-Bahn und Transportanlagen in weiten Grenzen von etwa 30 - 100 N.

Als Anpreßkraft für den Linienkontakt empfehlen wir ca. 15 N, für den Flächenkontakt ca. 5 N/cm<sup>2</sup> min.

In dieser Liste sind nur die gängigsten Typen aufgeführt. Wir stellen selbstverständlich auch jede gewünschte andere Ausführung her und bitten in diesem Falle um Einsendung von Mustern oder Skizzen.

## CURRENT COLLECTORS OF CARBON MATERIAL

Carbon inserts have obtained high reputation on account of their excellent characteristics.

The former used nonferrous metal current collectors had a big mechanical and electrical wear due to arcs, which caused welding beads.

Our qualities have been adopted to the individual demands, especially with regard to abrasion of the carbon and extreme careful treatment of the bus bar line, which is covered with protective film of high graphite contents, resulting in an essential decrease of friction and thus wear.

Arcs and radio interference suppression are thus avoided.

Carbon current collectors cannot be used, if the bus bar line is made of light metal material.

Our carbon inserts are supplied impregnated with a water-repellent liquid as to avoid harmful influences caused by humidity.

Chemical reactions which show bad influences become free by precipitation, by pollution or salty ambient conditions.

The pressure is varying in vast limits of 3 to 10 kgs., corresponding to the individual application, i.e. cranes, mine traction motors, trolleybusses, subways and transport equipment.

This list contains standard items only; besides those listed we manufacture any further requested performances.

## FROTTEURS EN CHARBON POUR PRISES DE COURANT

Les frotteurs en charbon pour prises de courant se sont imposés et ont fait leur preuve dans un très grand nombre de domaines, à cause de leurs multiples qualités.

Dans le passé, l'emploi des frotteurs en métaux non-ferreux était courant, mais leur usure rapide tant électrique que mécanique incita l'utilisateur à les remplacer par des frotteurs en charbon.

Nos qualités sont conformes aux multiples exigences, spécialement en ce qui concerne l'usure du frotteur et le ménagement du fil trolley, qui sera recouvert par un filin protecteur graphité, réduisant au minimum le frottement, donc l'usure.

Ces surfaces de frottement lisses évitent l'arc électrique ainsi que les perturbations radiophoniques.

Tous nos frotteurs en charbon sont imprégnés, évitant ainsi toute pénétration d'humidité.

Les précipitations, l'entraînement de saletés, ou d'autres nuisances, l'air salin peuvent provoquer des réactions chimiques nuisibles sur le frotteur.

La pression sur le frotteur peut varier suivant son utilisation, par exemple; sur ponts-roulants, locos de mine, trolleybus, métro, installations diverses de transport, entre 3 et 10 kg.

Ce catalogue ne présente que les types les plus courants.

Pour toute exécution autre que celles qui en font l'objet, prière de nous consulter à l'appui de dessin ou modèle.

## Schleifstücke für Krane und Oberleitungsfahrzeuge

Reference	Abmessungen - dimensions							Bemerkungen remarks remarques
	a	b	c	e	f	g	h	
07.02.01	80	26	24	6	8,5	12,5	5	Kanten gebrochen, ganz verkupfert halb verkupfert
07.02.02	80	25	24	6	7,5	11	3	
07.02.03	80	25	23	6	9	14	4	
07.02.04	80	20	25	6	7,5	9	4,5	ganz verkupfert
07.02.05	80	26	24	7	7,5	13	7	
07.02.06	80	25	25	5	7,5	14	4	
07.02.07	100	25	24	7	7	11	3	
07.02.08	79	25	23	9	10	15	4	
07.02.10	100	25	25	8,5	8,5	8	4	
07.02.11	100	50	30	8	8,5	20	4,5	ganz verkupfert
07.02.12	100	20	32	6,5	6,5	11	2,5	
07.02.14	80	26	24	7	7,5	12	5	
07.02.15	80	25	25	7	7,5	12	5	
07.02.16	80	26	17	6	7,5	-	-	
07.02.17	80	24	24	7,5	8	9,5	3	
07.02.18	80	25	23	8,5	10	14	4	ganz verkupfert
07.02.19	100	25	27	7	7,5	15	4	
07.02.20	79	25	23	10	10	14	4	

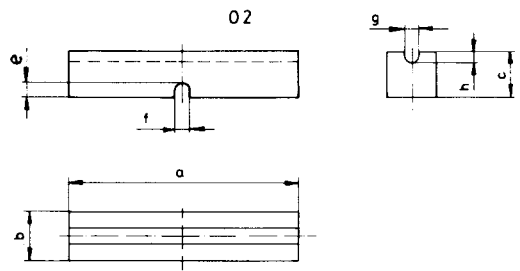

Reference	Abmessungen - dimensions								Bemerkungen remarks remarques
	a	b	c	e	f	g	h	i	
07.05.01	80	30	30	7	7	8	4	50	seitliche Bohrung, d = 5mm ganz verkupfert
07.05.02	110	26	24	7,5	7,5	12	6	83,5	
07.05.03	130	20	30	7	7,5	10	4	79,5	
07.05.04	120	25,8	24	7	7	12	6	95	ganz verkupfert
07.05.05	110	26	25	7,5	7,5	12	6	83,5	
07.05.07	90	25	25	8	7	16	4	62	
07.05.08	90	20	25	7	6,5	7	4	62	
07.05.09	80	30	30	7	7	8	2	50	Nut nicht verkupfert
07.05.10	110	26	24	7	8	12	6	86	

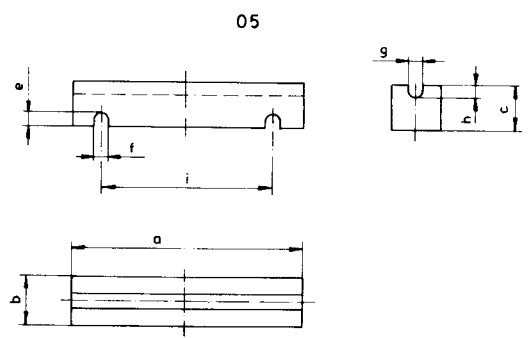

Reference	Abmessungen - dimensions					Bemerkungen remarks remarques
	a	b	c	g	h	
07.06.01	96	25	25	11	4	<p>Kopfseite Radius</p> <p>Anlaufschräge</p> <p>2 seitl. Bohrungen, d=6 verkupfert</p> <p>Stirnseite Kanten gebt. Anlaufschräge</p> <p>Laufsch. 45° 1x6</p>
07.06.02	115	30	25	13	6	
07.06.03	60	25	28	11	10	
07.06.04	-	-	-	-	-	
07.06.05	120	18	20	12	4	
07.06.07	80	30	28	11	6	
07.06.08	110	18	23	6,5	3	
07.06.09	100	25	25	12	6	
07.06.10	92,4	23,81	17,86	10	1,5	
07.06.11	90	28	18	14,5	4	
07.06.12	120	25	40	10	5	
07.06.13	85	20	25	10	4	
07.06.14	120	18	20	12	3	
07.06.15	95	25	25	10	5	
07.06.16	58	28	20,5	14	5	
07.06.17	120	40	30	24	9,5	

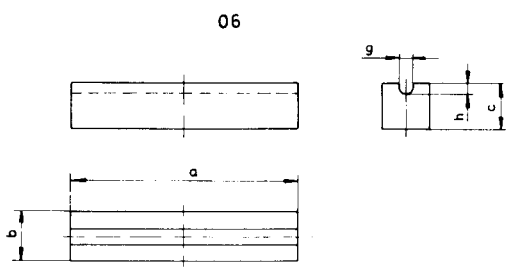

Reference	Abmessungen - dimensions										Bemerkungen remarks remarques
	a	b	c	d	e	f	g	h	i	r	
07.34.01	8	20	25	6	6	35	2,5	7,5	18	5	

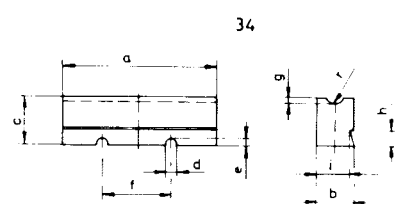



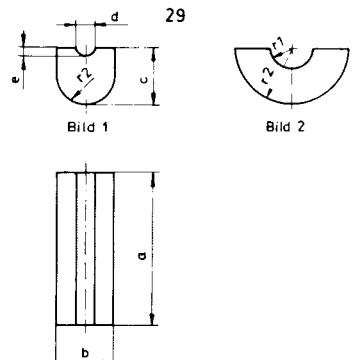

Reference	Abmessungen - dimensions								Bemerkungen remarks remarques
	a	b	c	d	e	r1	r2	Bild	
07.29.01	80	30	30	11	5	5,5	15	1	<p>Bild 1</p> <p>Bild 2</p>
07.29.02	70	20	20	8	10	4	10	-	
07.29.03	115	60	30	-	6	6	30	-	
07.29.04	60	62	31	-	-	20	31	2	

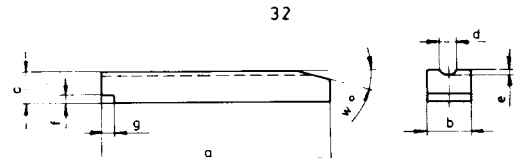

Reference	Abmessungen - dimensions								Bemerkungen remarks remarques
	a	b	c	d	e	f	g	w°	
07.32.01	120	24	16	13	2	4,5	7,5	15	<p>32</p>
07.32.02	120	24	16	9	2	4	7	15	

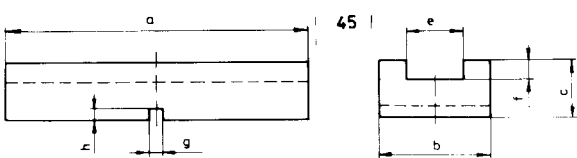
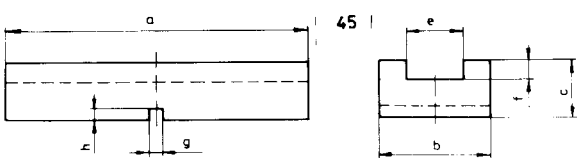

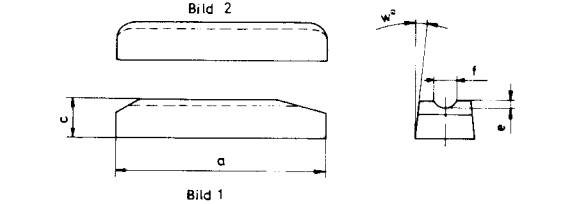
# Schleifstücke für Krane und Oberleitungsfahrzeuge

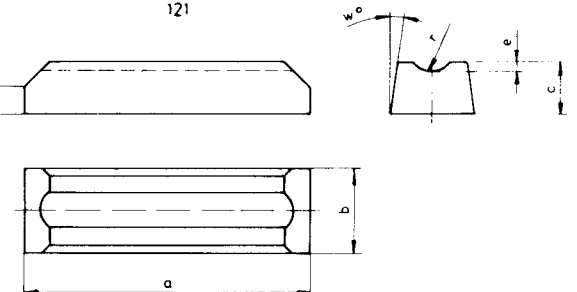
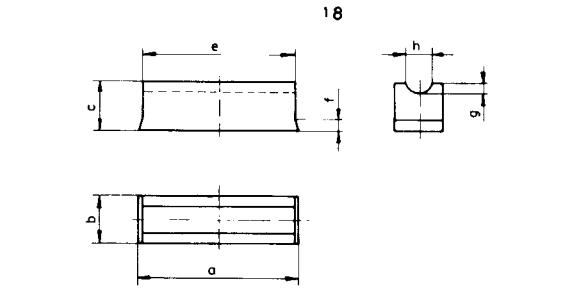
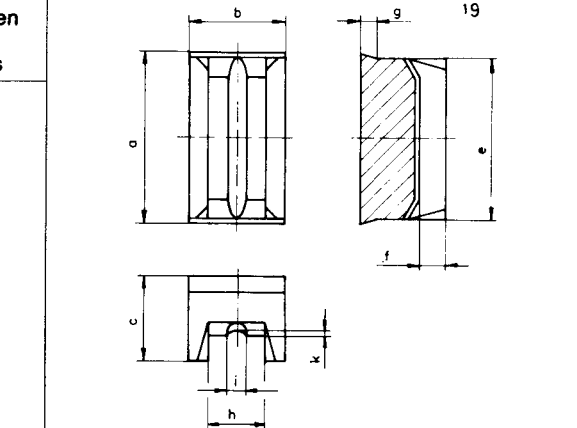
Reference	Abmessungen - dimensions								Bemerkungen remarks remarques	
	a	b	c	e	f	g	h	Bild		
07. 45. 01	160	60	36	30	10	7	6	1		
07. 45. 02	107	65	25	25	5	-	-	2		
										
										
										
										
										
										

Reference	Abmessungen - dimensions								Bemerkungen remarks remarques			
	a	b	c	e	f	g	h	i				
07. 96. 01	180	32	35	121	12	6	12	3,5				
Reference	Abmessungen - dimensions							Bemerkungen remarks remarques				
	a	b	c	e	f	g	h					
07. 104. 01	80	25,5	24	12	6	7,5	6,5	verkupfert				
Reference	Abmessungen - dimensions										Bemerkungen remarks remarques	
	a	b	c	d	e	f	g	h	i	k		
07. 27. 01	113	14	29	8,5	20,5	8	4	25	17,5	7		
Reference	Abmessungen - dimensions							Bemerkungen remarks remarques				
	a	b	c	e	f	r	R					
07. 126. 01	74	25,8	19	3	8	7,5	254					
Reference	Abmessungen - dimensions								Bemerkungen remarks remarques			
	a	b	c	e	f	g	h	i				
07. 15. 01	100	16	16	82	r=10	2	-	-				
07. 15. 02	100	16	17	82	5	2	-	-				
07. 15. 03	100	16	16	80	8	3	-	-				
07. 15. 04	80	35	16	48	12	2	5	22				
07. 15. 06	100	15,5	16,5	82	r=10	2	-	-				
07. 15. 07	100	24	18	80	9	1,5	-	-				
07. 15. 10	102	16	17	82	8	4	-	-				
07. 15. 11	107	65	25	-	25	5	-	-				
07. 15. 12	75	28	18	-	14,5	4	-	-				
07. 15. 13	42,5	16	24,5	-	5	2,5	-	-				

## Schleifstücke für Krane und Oberleitungsfahrzeuge

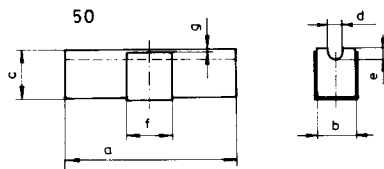
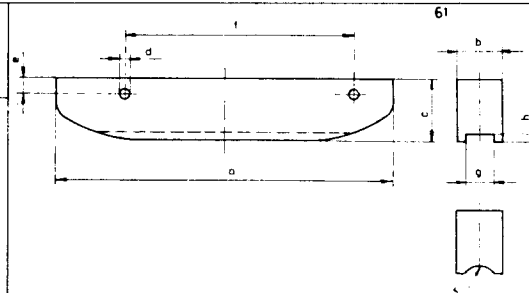
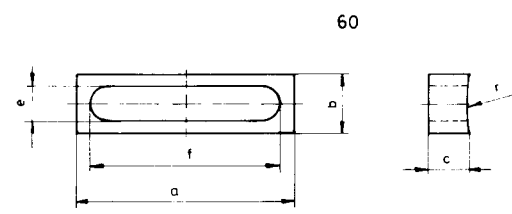
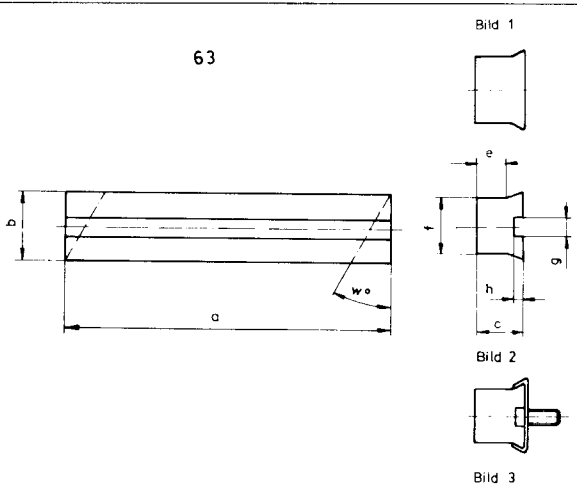
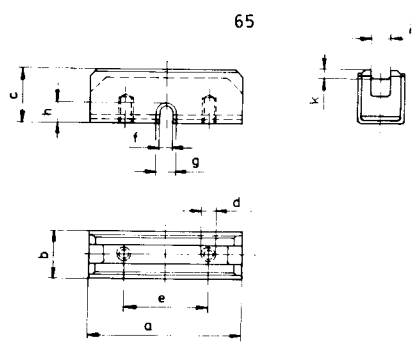
Reference	Abmessungen - dimensions							Bemerkungen remarks remarques				
	a	b	c	d	e	f	g					
07. 50. 01	90	20	25	7,5	6	25	1,5	verk., Bügel gelötet				
07. 50. 02	90	15	25	7,5	6	25	1,5					
07. 50. 03	90	15	25	10	5	25	1,5					
Reference	Abmessungen - dimensions									Bemerkungen remarks remarques		
	a	b	c	d	e	f	g	h	r			
07. 61. 01	200	30	40	6,5	10	150	18	5	-	Anlaufschräge 20°		
07. 61. 03	220	30	40	-	-	-	-	-	12			
Reference	Abmessungen - dimensions						Bemerkungen remarks remarques					
	a	b	c	e	f	r						
07. 60. 01	115	32	22	18	101	100						
Reference	Abmessungen - dimensions								Bemerkungen remarks remarques			
	a	b	c	e	f	g	h	Bild				
07. 63. 01	175	44	20	15	38	-	-	1	1/2 verkupfert $w^\circ = 30^\circ$ $w^\circ = 15^\circ$ ohne Schraube $w^\circ = 30^\circ$ ohne Schraube			
07. 63. 02	430	24	15	7,5	18	10	3,5	2				
07. 63. 03	375	40	23,5	13	33	8,5	4	3				
07. 63. 04	103	35	25,5	20	30	-	-	3				
07. 63. 05	233	35	30	24,5	30	-	-	3				
07. 63. 06	150	35	25	20	30	-	-	1				
Reference	Abmessungen - dimensions										Bemerkungen remarks remarques	
	a	b	c	d	e	f	g	h	i	k		
07. 65. 01	60	24	26	M 5	38	8,5	10	9	9	3	1/2 verkupfert	
07. 65. 02	60	24	25,5	M 6	38	8,5	10	9	10,5	5		



Reference	Abmessungen - dimensions								Bemerkungen remarks remarques
	a	b	c	d	e	f	g	h	
07. 67. 01	100	26	19	M 8	45	35	30	26	MS Einlage und Cu-Bügel MS Einlage und Cu-Bügel
07. 67. 02	120	26	19	M 8	45	45	30	26	

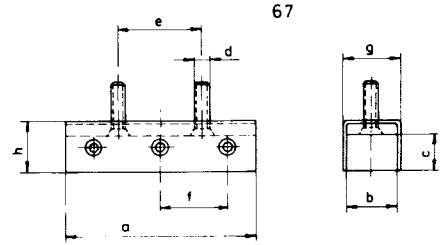

Reference	Abmessungen - dimensions							Bemerkungen remarks remarques
	a	b	c	d	e	f	g	
07. 140. 01	100	26	19	M8	28	18	14	

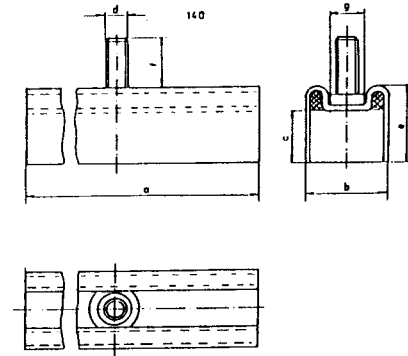

Reference	Abmessungen - dimensions					Bemerkungen remarks remarques
	a	b	c	e	f	
07. 75. 01	72	23	19	3	12	
07. 75. 02	72	20	19	1,5	9,5	

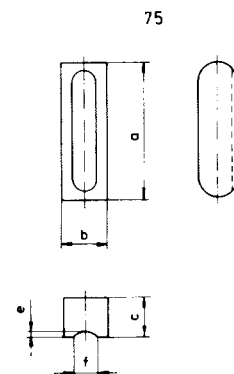

Plattenförmige Schleifstücke für Stromabnehmer

Reference	Abmessungen - dimensions								Bemerkungen remarks remarques
	a	b	c	d	e	f	g	h	
07.01.01	140	80	30	11	24	8	-	-	
07.01.02	100	80	20	-	-	-	-	-	
07.01.03	135	100	30	10	34	3	-	-	
07.01.04	140	80	30	10	70	13	-	-	
07.01.05	140	100	30	10	70	13	-	-	
07.01.06	140	105	30	10	70	10	-	-	
07.01.07	140	80	30	8,5	25	5	-	-	
07.01.08	140	80	30	8,5	70	7,5	-	-	
07.01.09	95	64	18	-	-	-	-	-	
07.01.10	140	80	30	-	-	-	-	-	
07.01.12	125	100	30	-	-	-	-	-	
07.01.13	140	50	30	-	-	-	-	-	
07.01.14	125	100	35	-	-	-	-	-	
07.01.15	140	100	30	10	33	3,5	-	-	
07.01.16	140	70	30	11	24	8	-	-	
07.01.17	100	80	20	8	50	9	-	-	
07.01.19	130	95	30	-	-	-	-	-	
07.01.20	95	107	35	-	-	-	-	-	
07.01.21	95	90	35	-	-	-	-	-	
07.01.22	125	100	35	-	-	-	30	5,5	
07.01.23	140	30	50	-	-	-	-	-	
07.01.24	200	90	30	-	-	-	-	-	
07.01.25	200	110	35	-	-	-	-	-	
07.01.27	90	100	35	-	-	-	-	-	
07.01.28	100	80	40	-	-	-	-	-	
07.01.29	100	50	20	-	-	-	-	-	
07.01.30	140	80	30	8,5	25	5,5	-	-	
07.01.31	95	90	30	-	-	-	-	-	
07.01.32	140	50	30	M 10	70	16	-	-	
07.01.33	120		20	-	-	-	-	-	
07.01.34	140	50	30	10/9	70	30	-	-	
07.01.35	140	50	30	9,5	70	12	-	-	
07.01.36	100	50	20	9,5	50	3,5	-	-	

eine Anlaufkante R9  
(Wendesleifst.)

1/2 verkupfert

Lauffläche Kantenbruch 7 x 45°

4 Bohrungen d = 16/9

seitliche Rille R5

4 Kanten abgerundet

Reference	Abmessungen - dimensions								Bemerkungen remarks remarques
	a	b	c	e	f	g	h		
07.82.01	70	50	24	5,5	4	16,5	9,5		

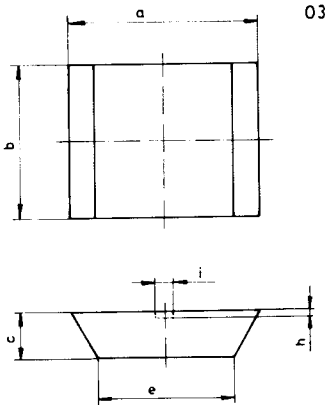
Reference	Abmessungen - dimensions						Bemerkungen remarks remarques	
	a	b	c	e	i	h		
07. 03. 01	150	110	30	110	-	-	 <p>03</p>	
07. 03. 02	140	76	30	120	-	-		
07. 03. 03	100	80	22	82	-	-		
07. 03. 04	100	110	18	86	-	-		
07. 03. 05	150	54	30	110	-	-		
07. 03. 06	100	210	20	85	-	-		
07. 03. 07	100	16	18	80	-	-		
07. 03. 08	140	80	30	120	-	-		
07. 03. 09	100	80	18	86	3,5	3		
07. 03. 10	125	115	20	110	-	-		4 Bohrungen d = 16/8
07. 03. 12	80	100	30	58	-	-		
07. 03. 13	140	140	30	120	-	-		
07. 03. 14	180	90	25	150	-	-		1/2 verkupfert
07. 03. 15	75	40	22	65	-	-		1/2 verkupfert
07. 03. 16	100	80	18	86	-	-		
07. 03. 17	100	80	25	80	4,2	4		Fläche verk., 4 Boh- rungen m. Gew. M8
07. 03. 18	80	80	30	60	-	-		
07. 03. 19	94	100	25	70	-	-		halb verkupfert
07. 03. 20	100	150	20	85	-	-		mit Nut d = 3,5x3,5
07. 03. 21	100	80	18	86	-	-		
07. 03. 22	180	90	25	~150	8	5		
07. 03. 23	140	120	30	115	-	-		

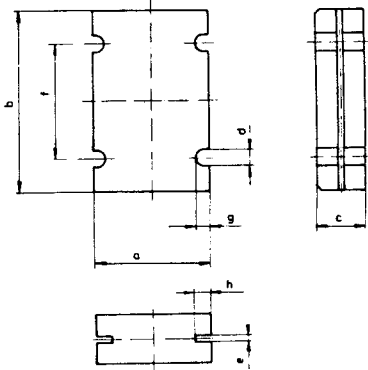
Reference	Abmessungen - dimensions								Bemerkungen remarks remarques
	a	b	c	d	e	f	g	h	
07. 12. 01	70	110	30	14	-	70	4,5	-	 <p>12</p>
07. 12. 02	80	140	30	10	4	80	7,5	10	
07. 12. 03	70	110	30	8	-	70	6	-	
07. 12. 04	85	130	25	18	-	80	13	-	
07. 12. 05	70	110	30	9	-	67	5	-	

Reference	Abmessungen - dimensions						Bemerkungen remarks remarques
	a	b	c	e	f	r	
07. 120. 01	16	50	20	9	12	45	*) 1/2 verkupfert
07. 120. 02	30	50	23	8	24	25	*)
07. 120. 03	16	50	20	9	12	40	*) 1/2 verkupfert
07. 120. 04	54	100	36	11	45	150	*) Kontakte

## Plattenförmige Schleifstücke für Stromabnehmer

Reference	Abmessungen - dimensions								Bemerkungen remarks remarques
	a	b	c	e	f	g	h	i	
07. 04. 01	42,5	96	23	6	37	33	-	-	1/2 verkupfert
07. 04. 02	42,5	103	23	6	37	33	-	-	1/2 verkupfert
07. 04. 03	140	80	30	8,5	140	130	-	-	
07. 04. 04	140	100	30	12,5	138,5	122	-	-	
07. 04. 05	140	80	30	12	140	132,5	-	-	
07. 04. 06	140	120	30	13	140	131	-	-	
07. 04. 07	140	50	30	8	140	130	-	-	
07. 04. 08	140	100	30	8	140	130	-	-	
07. 04. 09	100	50	20	6	100	93	-	-	
07. 04. 10	70	34	24	7	70	64	-	-	
07. 04. 11	140	100	30	8,5	140	129	-	-	
07. 04. 12	125	100	35	11	125	120	-	-	
07. 04. 13	80	100	30	12	80	72	-	-	
07. 04. 14	80	120	30	12	80	70	-	-	
07. 04. 15	125	100	35	13	125	120	-	-	
07. 04. 16	80	60	30	12,5	80	79	-	-	
07. 04. 17	69	34	24	6	69	63	-	-	
07. 04. 19	140	100	30	8	140	130	-	-	2 Bohrungen d = 12 x 11
07. 04. 20	125	99	35	12	125	120	-	-	
07. 04. 21	100	50	30	8,5	100	92	-	-	
07. 04. 22	140	100	30	12,5	138	122	-	-	
07. 04. 23	80	80	30	12	80	74	-	-	
07. 04. 24	125	100	35	11	123,5	120	-	-	
07. 04. 25	100	50	20	9	100	92	-	-	
07. 04. 26	140	80	30	12	140	132	-	-	
07. 04. 27	140	100	30	8	136	127	-	-	
07. 04. 28	100	50	20	6	98	92	-	-	
07. 04. 30	100	80	30	12	100	88	-	-	
07. 04. 31	80	60	30	12	80	72	-	-	
07. 04. 32	80	94	30	12	80	72	-	-	
07. 04. 33	100	80	30	8	60	50	-	-	
07. 04. 34	140	100	30	12	140	132	-	-	
07. 04. 35	80	70	30	12	80	72	-	-	
07. 04. 36	80	100	30	12	80	72	-	-	
07. 04. 37	140	120	30	13	140	131	-	-	
07. 04. 39	40	200	19	5	36,7	33	-	-	mit Blecheinfassung
07. 04. 40	140	100	30	12,5	140	128	-	-	
07. 04. 41	100	100	30	14	100	88	-	-	
07. 04. 42	100	80	20	6	100	93	-	-	
07. 04. 43	140	80	30	8	140	128	-	-	

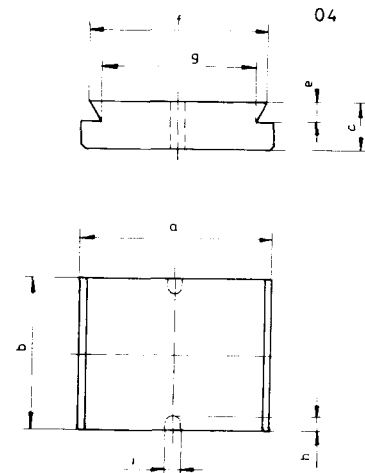

Reference	Abmessungen - dimensions								Bemerkungen remarks remarques
	a	b	c	e	f	g	h	i	
07. 04. 44	130	48	30	15	106	90	-	-	
07. 04. 45	140	100	30	9	140	128	-	-	
07. 04. 46	140	80	30	10	140	124	-	-	
07. 04. 47	125	90	25	11	122	118	-	-	
07. 04. 48	80	140	30	12	80	72	8,5	7	
07. 04. 49	140	100	30	12	140	132	-	-	
07. 04. 50	100	50	20	10	100	92	-	-	
07. 04. 51	140	100	30	12	140	130	-	-	
07. 04. 52	140	80	30	12	139,5	128	-	-	
07. 04. 53	80	80	30	12	79,3	-	-	-	
07. 04. 54	125	100	30	12	125	119	-	-	
07. 04. 55	140	120	30	12	140	-	-	-	

Reference	Abmessungen - dimensions							Bemerkungen remarks remarques
	a	b	c	e	f	g	h	
07. 129. 01	100	64	32	56	45	48	13	

Reference	Abmessungen - dimensions								Bemerkungen remarks remarques
	a	b	c	e	f	g	h	i	
07. 07. 01	100	80	37	8	60	-	-	-	
07. 07. 03	100	80	35	7	60	-	-	-	
07. 07. 04	100	78	30	8	60	-	-	-	
07. 07. 05	90	140	30	10	80	6,5	5	101,5	
07. 07. 06	80	80	35	8	60	-	-	-	

Reference	Abmessungen - dimensions										Bemerkungen remarks remarques	
	a	b	c	e	f	g	h	i	k	l		
07. 08. 01	110	95	32	100	64	50	10	7,5	3,5	60	1/2 verkupfert	
07. 08. 02	110	95	32	100	60	50	10	8	5	60	1/2 verkupfert	
07. 08. 03	80	95	32	70	40	30	10	7	3,5	61	1/2 verkupfert	
07. 08. 04	80	110	32	70	55	45	10	7,5	4	42	1/2 verkupfert	
07. 08. 05	160	85	32	150	112	100	10	7	3,5	60	1/2 verkupfert	
07. 08. 06	110	95	30	100	60	50	10	6	3	60	1/2 verkupfert	
07. 08. 07	160	95	32	150	112	100	10	9	4,5	60	1/2 verkupfert	

Plattenförmige Schleifstücke für Stromabnehmer

Reference	Abmessungen - dimensions									Bemerkungen remarks remarques	
	a	b	c	d	e	f	g	h	Bild		
07.09.01	200	80	30	d=12	10	130	55	5,5	1		
07.09.03	180	80	25	-	15	140	-	-	2		
07.09.04	180	100	25	-	15	140	-	-	2		
07.09.05	160	130	30	-	15	110	-	-	2		

Reference	Abmessungen - dimensions					Bemerkungen remarks remarques	
	a	b	c	f	r		
07.10.01	95	107	35	-	7	1	eine Fl. verzinkt
07.10.02	100	140	30	-	-	1	
07.10.03	95	105	35	-	8	1	
07.10.04	80	80	30	-	-	1	
07.10.05	110	50	20	-	-	1	
07.10.06	100	80	40	3,5	5	2	

Reference	Abmessungen - dimensions							Bemerkungen remarks remarques	
	a	b	c	d	e	f	g		
07.11.01	80	140	30	11	20	50	15		
07.11.02	100	160	40	21/ 10,5	20	120	40		
07.11.05	95	117	35	M 10	23,5	70	35		
07.11.06	95	107	35	M 10	18	71	35		
07.11.08	100	140	30	11	20	50	15		
07.11.09	80	120	30	M 10	25	70	20		

Reference	Abmessungen - dimensions									Bemerkungen remarks remarques	
	a	b	c	d	e	f	g	h	Bild		
07.17.01	160	100	27	18	5	20	105	108	1	verk.	
07.17.03	81	35	14	9	3	9	48,5	56	1	verk.	
07.17.04	81	50	14	8	3	9	48,5	56	1	verk.	
07.17.05	81	35	23	8	3	18	48,5	50	1	verk.	
07.17.06	127	80	20	14	5	15	77	90	1	verk.	
07.17.07	127	120	20	14	5	15	77	90	1	verk.	
07.17.10	81	35	14	8	3	9	58	55	2	mit Bügel	
07.17.11	80	35	16,5	-	-	11,5	22	50	3	verk.	

Reference	Abmessungen - dimensions							Bemerkungen remarks remarques
	a	b	c	d	e	f	g	
07. 54. 01	80	35	16	M 6	20	27	27,5	
07. 54. 02	79,4	50	16,5	M 6	20	23,5	23,5	

54

Reference	Abmessungen - dimensions					Bemerkungen remarks remarques
	a	b	c	d	e	
07. 26. 01	120	70	25	8,5	7,5	
07. 26. 02	100	80	30	7	7	

26

Reference	Abmessungen - dimensions						Bemerkungen remarks remarques
	a	b	c	e	f	g	
07. 55. 01	130	100	35	10	12	60	

55

Reference	Abmessungen - dimensions							Bemerkungen remarks remarques
	a	b	c	d	e	f	g	
07. 95. 01	83	122	20	M 8	100	12	80	

95

Plattenförmige Schleifstücke für Stromabnehmer

Reference	Abmessungen - dimensions							Bemerkungen remarks remarques	97
	a	b	c	e	f	d1	d2		
07. 97. 01	150	80	16	110	40	8,5	22		
Reference	Abmessungen - dimensions						Bemerkungen remarks remarques	128	
	a	b	c	d	e	f			
07. 128. 01	122	63	16	M8	30	6			
Reference	Abmessungen - dimensions						Bemerkungen remarks remarques	13	
	a	b	c	e	f	Bild			
07. 13. 01	139	100	30	131	6	1	Wende-Lauffläche		
07. 13. 02	140	80	40	130	23	2			



Reference	Abmessungen - dimensions						Bemerkungen remarks remarques
	a	b	c	e	f	g	
07. 14. 01	100	80	18	86	3,5	3,5	Fl. verk.
07. 14. 02	100	80	20	86	3,5	3,5	
07. 14. 03	100	160	18	86	3,5	3,5	
07. 14. 04	100	210	18	86	4	3	
07. 14. 05	100	80	25	81	3,5	3,5	

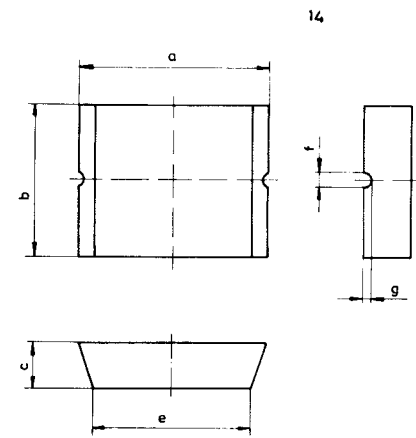

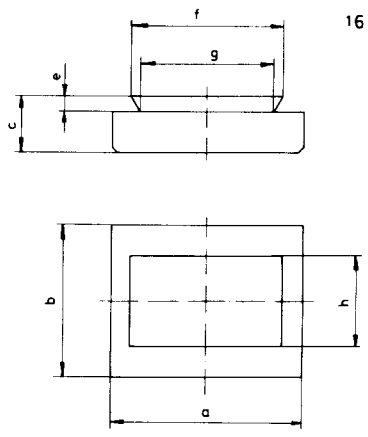
Reference	Abmessungen - dimensions							Bemerkungen remarks remarques
	a	b	c	e	f	g	h	
07. 16. 01	80	100	35	8	79,5	75,5	60	
07. 16. 02	80	100	35	8	79	74	60	
07. 16. 03	200	100	30	8	80	75	60	
07. 16. 04	100	80	20	8	60	52	80	
07. 16. 05	100	80	30	8	60	52	80	
07. 16. 06	80	100	35	8	79	75,5	60	
07. 16. 07	150	100	35	8	79	74	60	
07. 16. 08	80	100	30	8	79,5	75,5	60	
07. 16. 09	100	80	35	8	79,5	75,5	60	
07. 16. 10	125	80	30	10	100	91	50	

Plattenförmige Schleifstücke mit Kabel für Stromabnehmer

Reference	Abmessungen - dimensions									Bemerkungen remarks remarques
	a	b	c	e	f	g	h	L	Bild	
07. 28. 01	140	100	30	50	7,5	3	12	110	1	
07. 28. 02	100	100	30	50	8	4	12	90	1	
07. 28. 03	160	100	30	50	7,5	3	12	120	1	
07. 28. 04	80	70	25	40	8	7	6	64	2	
07. 28. 05	80	70	25	35	9	7	8	75	2	
07. 28. 06	100	100	30	50	8	7	12	120	4	
07. 28. 07	140	100	30	50	8	7	12	115	4	
07. 28. 08	120	100	30	52	8	7	10	123	4	
07. 28. 09	140	100	30	52	8,5	7,5	11	115	4	
07. 28. 10	100	100	30	50	-	-	12	115	4	Gew. M10x12 mitte
07. 28. 11	100	100	40	52	8	7	10	120	1	
07. 28. 12	120	100	40	52	8	7	10	120	1	
07. 28. 13	140	100	30	50	-	-	12	180	4	Gew. M10x14 mitte
07. 28. 14	80	70	25	40	8,5	7,5	7	70,5	2	
07. 28. 15	120	70	30	52	8	7	10	115	4	
07. 28. 16	78	70	25	40	8,5	7	8	80	3	
07. 28. 17	80	70	25	40	8	7	12,5	65	2	
07. 28. 18	100	100	30	52	7	8	10	120	1	
07. 28. 19	120	100	30	54	7	7	10	130	4	
07. 28. 20	130	100	30	52	8	8	10	120	4	
07. 28. 21	160	100	30	53	8	7	10	150	4	
07. 28. 22	80	70	25	40	8,5	7	12,5	72	2	
07. 28. 23	120	100	30	52	7,5	4	12	123	1	
07. 28. 24	100	100	30	50	8	7	10	100	4	
07. 28. 25	80	70	25	35	9	7	8	80	4	
07. 28. 26	100	100	30	52	7	8	10	115	4	
07. 28. 27	65	100,3	30,3	54	7	8	10	115	4	
07. 28. 28	80	69,8	25	40	8	7	8	60	2	
07. 28. 29	100	100	30	52	8	7	10	100	4	
07. 28. 30	104	100	30	52	8	7	12	110	2	
07. 28. 31	100	100	30	52/77	8	8	10		5	

Reference	Abmessungen - dimensions								Bemerkungen remarks remarques
	a	b	c	d	e	f	L	D	
07. 56. 01	100	70	25	8	7	15	96	8,5	
07. 56. 02	120	70	25	8	8	15	100	8,5	
07. 56. 03	80	70	25	7	9	15	85	8,5	

Reference	Abmessungen - dimensions							Bemerkungen remarks remarques
	a	b	c	d	e	f	g	
07. 130. 01	151	70	30	9	60	5	5	

Plattenförmige Schleifstücke mit Kabel für Stromabnehmer

Reference	Abmessungen - dimensions													Bemerkungen remarks remarques
	a	b	c	e	f	g	h	i	k	l	L	D	Bild	
07. 20. 01	160	100	30	78	60	7	4	80	9	7	115	9,5	1	
07. 20. 02	120	140	30	118	100	7	4	60	9,5	7	120	9	2	
07. 20. 03	105	86	30	64	40	7	4	60	8,3	7	110	9	1	
07. 20. 04	160	100	30	78	60	7	4	80	8,5	7	115	9	1	
07. 20. 05	160	172	30	150	130	7	10	80	9	7	160	11	1	
07. 20. 06	100	90	30	70	50	7	5	60	9	7	110	10,5	2	
07. 20. 07	100	110	30	90	25/50	7	5	60	9	8,5	110	10,5	2	
07. 20. 08	105	86	30	64	46	7	4	60	8,3	7	115	8	2	
07. 20. 10	100	110	30	90	50	7	4,8	60	8	8	105	10,5	2	
07. 20. 11	100	200	30	180	25/50	7	5	60	9	8,5	110	10,5	2	

Reference	Abmessungen - dimensions											Bemerkungen remarks remarques
	a	b	c	e	f	g	h	i	k	L	D	
07. 64. 01	100	48	30	3	9	6	8	25	10	115	8	

Reference	Abmessungen - dimensions										Bemerkungen remarks remarques
	a	b	c	e	f	g	d1	d2	L	D	
07. 74. 01	200	185	30	120	105	13	16	9,8	185	8,5	

Reference	Abmessungen - dimensions							Bemerkungen remarks remarques
	d	d1	l	c	D	D1	L	
07. 21. 01	94	75	34,6	22	22	18,2	34,6	MS Büchse

21

Reference Profil	Abmessungen - dimensions						Bemerkungen remarks remarques
	a	b	c	r	d1	d2	
P 0	53	48	-	7	11-18	-	auch ohne Bohrung
P 4	74	68	-	12	14-22	-	
P 5	60	54	-	7	10-18	-	
P 10	82	73	-	10	14-22	-	
07. 22. 15	60	54	17	7	16,5	5,5	mit MS Buchse
07. 22. 16	82	73	-	11	15	-	
07. 22. 17	77,5	70	-	9	16	-	
07. 22. 18	74,5	68	-	12	17	-	
07. 22. 19	63	63	-	30	17,5	-	

22

Maß "l" bei Bestellung angeben

Bild 2

Ausführung mit Keinut

Maße "e" und "f" bei Bestellung angeben

Reference	Abmessungen - dimensions						Bemerkungen remarks remarques
	a	b	d	r	D	Bild	
07. 23. 07	74	68	16	12	85	1	Schleifstücke mit Begrenzungsscheiben und eingietetem Messingrohr weitere lieferbare Begrenzungsscheiben mit Durchmesser 75, 100 und 105 mm
07. 23. 08	75	68	18	12	85	1	
07. 23. 09	60	54	12	7	68	1	
07. 23. 10	60	54	16	7	68	1	
07. 23. 11	82	73	20	10	110	1	
07. 23. 14	82	73	16	10	85	1	
07. 23. 15	76	70	10	12	100	2	

23

Maß "l" bei Bestellung angeben

Bild 1

Bild 2

## Schleifstücke und Kontakte für Kleinschleifleitungen

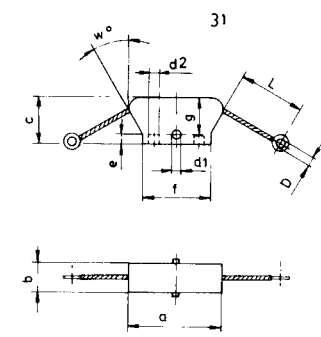
Reference	Abmessungen - dimensions											Bemerkungen remarks remarques	31 
	a	b	c	d1	d2	e	f	g	w°	L	D		
07. 31. 01	50	15	24	5	6	7	36	16,5	30	34	4,2	Konische Bohrung mitte d = 9	
07. 31. 02	50	15	24	6	8	6	36	16,5	30	34	4,2		
07. 31. 03	50	15	24	5	8	6	36	16,5	30	40	4,2		

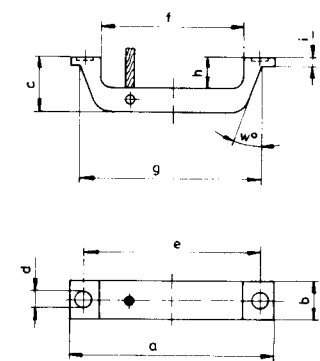
Reference	Abmessungen - dimensions										Bemerkungen remarks remarques	118 
	a	b	c	d	e	f	g	h	i	w°		
07. 118. 01	53,8	10	14	3,8	45,5	38	48	8	2	20	Cu Litze PVC isol. 300 lg	

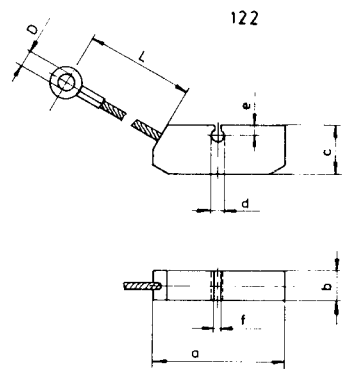
Reference	Abmessungen - dimensions								Bemerkungen remarks remarques	122 
	a	b	c	d	e	f	L	D		
07. 122. 01	34,5	7,5	12,5	3	2,5	2,2	35	4,3		

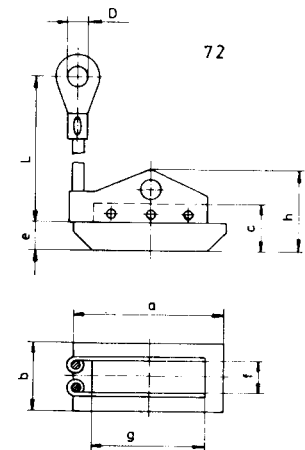
Reference	Abmessungen - dimensions									Bemerkungen remarks remarques	72 
	a	b	c	e	f	g	h	L	D		
07. 72. 01	80	35	25	15	16	60	42	235	10,4		
07. 72. 02	50	20	20	10	16	50	36	180	10,4		

Reference	Abmessungen - dimensions												Bemerkungen remarks remarques
	a	b	c	d	e	f	g	h	i	L	D		
07. 89. 01	30	45	18	5	20	31	13,5	8	6,5	150	7,5		

Reference	Abmessungen - dimensions										Bemerkungen remarks remarques
	a	b	c	d	e	f	g	r	L		
07. 106. 01	8	42	22	6	9	6	32	40	185	Endhülse	

Reference	Abmessungen - dimensions												Bemerkungen remarks remarques
	a	b	c	d	e	f	g	h	r	L	D		
07. 37. 01	80	19	52	8,5	23,5	41	30	18	145	199	12	isol. Litze	

Reference	Abmessungen - dimensions						Bemerkungen remarks remarques
	a	b	c	d	e	f	
07. 134. 01	30	15	18	4	5,5	4	

Reference	Abmessungen - dimensions									Bemerkungen remarks remarques
	a	b	c	d	e	f	g	h	r	
07. 107. 01	70	19	40	8,3	22	13	35	22	150	

Reference	Abmessungen - dimensions							Bemerkungen remarks remarques
	a	b	c	d	e	f	g	
07. 142. 01	26	14	13	8,3	12	20	5,2	

Reference	Abmessungen - dimensions									Bemerkungen remarks remarques
	a	b	c	d	e	f	L	D	Bild	
07. 85. 01	11,9	25,4	19	6,6	6,3	11,5	140	7	1	
07. 85. 02	25	35	20	6	4,5	7,5	110	6,4	2	



Reference	Abmessungen - dimensions											Bemerkungen remarks remarques	
	a	b	c	d	e	f	g	h	i	Bild	L		D
07. 53. 01	90	32	34	28	8,4	27	50	10	-	2	95	8,3	
07. 53. 02	90	34	43	28	11	36	58	10	70	1	80	6,5	
07. 53. 03	90	34	43	28	11	36	60	10	70	1	85	6,5	
07. 53. 04	99	37	43	-	-	-	-	-	69	1	93	6,5	

Reference	Abmessungen - dimensions								Bemerkungen remarks remarques	
	a	b	c	e	f	g	h	L		
07. 102. 01	43,5	9,8	11	53,5	19	8	2,5	235	Stiftkabelschuh	

Reference	Abmessungen - dimensions									Bemerkungen remarks remarques	
	a	b	c	d	e	f	g	r	L		
07. 88. 01	40	12	16	3	3	26	6	25	40	Bohreinfassung Litze isoliert	

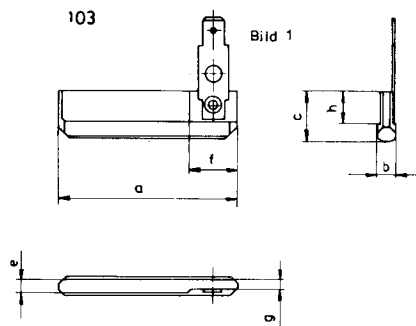
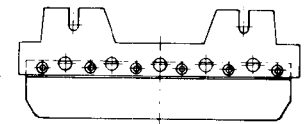
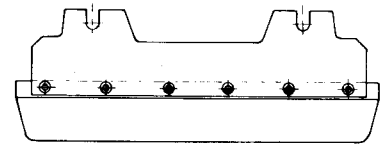
Reference	Abmessungen - dimensions								Bemerkungen remarks remarques	103 Bild 1 
	a	b	c	e	f	g	h	Bild		
07. 103. 01	47	4,9	14,5	3,65	12,5	2,2	8,3	1	Blechfassung	
07. 103. 02	140	6	30	4	-	-	8	2		
07. 103. 04	47,5	5	12,5	3,5	12,5	2,2	8,3	1		
07. 103. 05	189	8	46,5	3,5	-	-	8,5	3		
07. 103. 06	47	5	12,5	3,63	-	2,2	8	1		
										Bild 2  Bild 3 

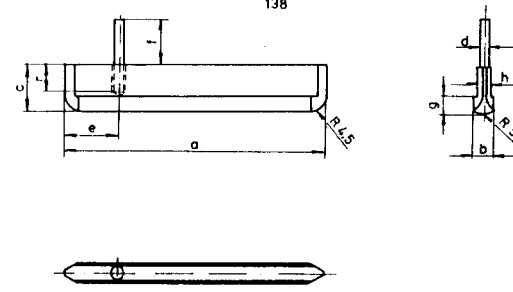
Reference	Abmessungen - dimensions									Bemerkungen remarks remarques	138 
	a	b	c	d	e	f	g	h	r		
07. 138. 01	68	5	12,5	2,8	14	13	4,5	3,7	7	bronze	
07. 138. 02	68	5	14,6	2,8	14	13	4,5	3,7	7	schwarz	

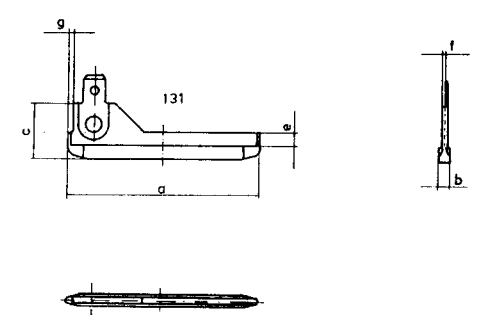
Reference	Abmessungen - dimensions						Bemerkungen remarks remarques	131 
	a	b	c	e	f	g		
07. 131. 01	50	3	15	3,2	0,7	1,5	Schutzleiter	
07. 131. 02	50	3	15	3,2	0,7	1,5		
07. 131. 04	56	3	19	3,5	1,8	-		

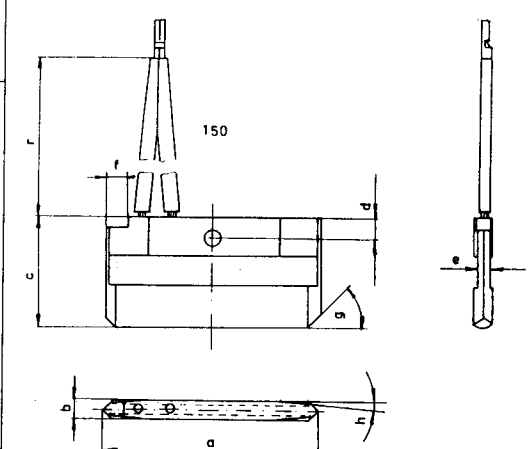
Reference	Abmessungen - dimensions									Bemerkungen remarks remarques	150 
	a	b	c	d	e	f	g	h	r		
07. 150. 01	55,5	5	30	6	3	6	45°	5°	190		

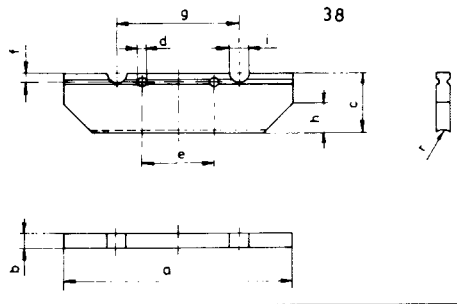
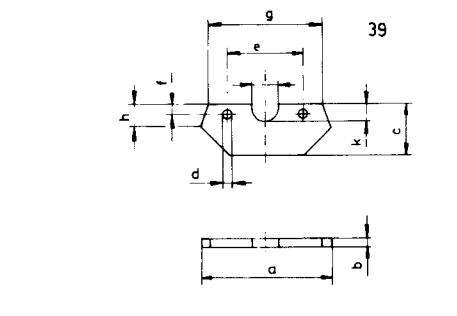
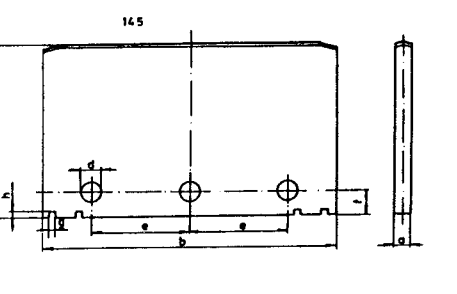
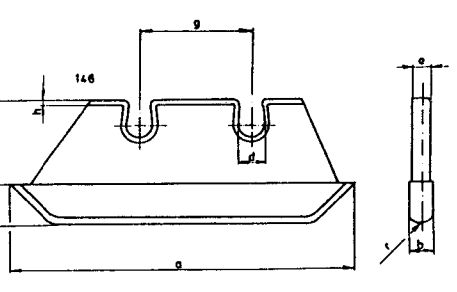
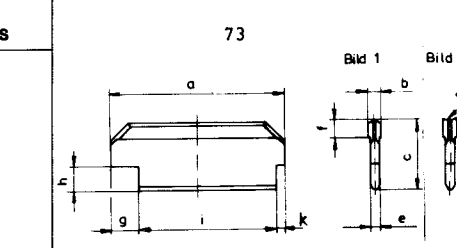
Reference	Abmessungen - dimensions										Bemerkungen remarks remarques		
	a	b	c	d	e	f	g	h	i	r			
07. 38. 01	120	7	25,5	5,2	38	4,25	62	8	8	5			
07. 38. 02	119,5	6,5	30	5	38,5	4,5	64	15	9,5	5			
Reference	Abmessungen - dimensions										Bemerkungen remarks remarques		
	a	b	c	e	f	g	h	i	k	d			
07. 39. 01	67	5	25,5	41	4,5	60	12	14,5	9	5,2			
Reference	Abmessungen - dimensions								Bemerkungen remarks remarques				
	a	b	c	d	e	f	g	h					
07. 145. 01	5	90	55	6,2	30	8	2	1,5					
Reference	Abmessungen - dimensions										Bemerkungen remarks remarques		
	a	b	c	d	e	f	g	h	r				
07. 146. 01	53	4	20	3,95	2,9	6,5	17	4	2,5				
Reference	Abmessungen - dimensions											Bemerkungen remarks remarques	
	a	b	c	e	f	g	h	i	k	r	Bild		
07. 73. 01	90	5	36	3,5	9	15	13	72	3	0	1		
07. 73. 02	90	5	36	3,5	9	15	13	72	3	4,7	2		
07. 73. 03	160	7	63	5	15	36	24	119	5	-	1		

Reference	Abmessungen - dimensions								Bemerkungen remarks remarques	76				
	a	b	c	e	f	g	h	k						
07. 76. 01	73,5	5	36	3,5	9	1,5	13	10,5						
Reference	Abmessungen - dimensions							Bemerkungen remarks remarques	77					
	a	b	c	e	f	g	h							
07. 77. 01	160	7	58	5	10	32	24							
Reference	Abmessungen - dimensions								Bemerkungen remarks remarques	105				
	a	b	c	d	e	f	i	r						
07. 105. 01	100	4	32	5,3	50	8	69,5	20	Blechfassung					
07. 105. 02	80	4	30	-	32	9	70	13	2 Blechbügel					
Reference	Abmessungen - dimensions										Bemerkungen remarks remarques	86		
	a	b	c	d	e	f	g	h	i	w°				Bild
07. 86. 01	82	5	31,5	-	-	64	71	13,5	35	-	1			
07. 86. 02	80,5	5	27	4,6	10,5	63,5	70,5	13	35	-	1			
07. 86. 03	105	5	31,5	-	-	96,4	71	13,5	35	-	1			
07. 86. 04	110	6	28	5	11	64	71	13	34,3	30	2			
07. 86. 05	100	18	25,5	5	10	63	70	13	-	45	~2			
Reference	Abmessungen - dimensions						Bemerkungen remarks remarques	Kohle mit Halter montiert						
	a	b	c	d	e	f								
07. 144. 01	50	4	33	6,3	38	14								

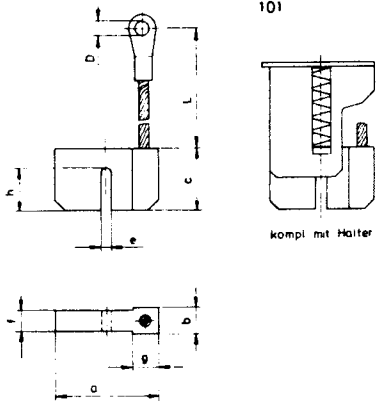
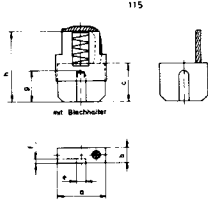
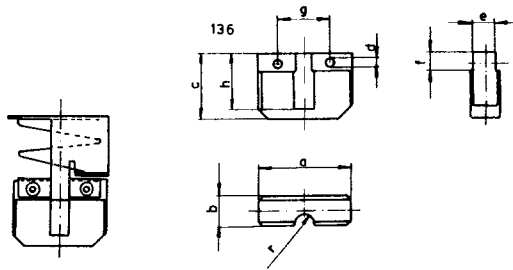
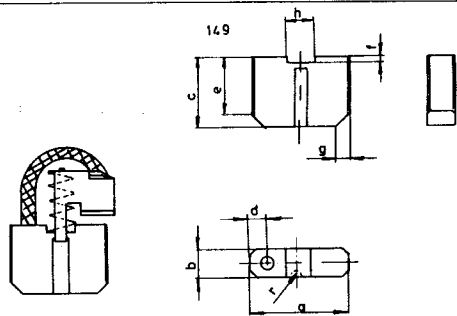
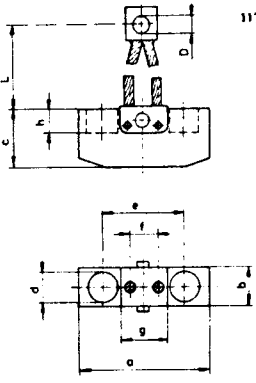
Reference	Abmessungen - dimensions										Bemerkungen remarks remarques		
	a	b	c	e	f	g	h	L	D				
07. 101. 01	32	8	19	3,5	6,4	8	13	58	3,4	Kompl. mit Halter			
07. 101. 02	32	8	19	3,5	6,4	8	13	58	3,4				
Reference	Abmessungen - dimensions								Bemerkungen remarks remarques				
a	b	c	e	f	g	h							
07. 115. 01	25	8	20	5	2,5	16	60	mit Halter					
Reference	Abmessungen - dimensions										Bemerkungen remarks remarques		
a	b	c	d	e	f	g	h	r					
07. 136. 01	24,5	8	17,5	2,1	6,4	5	14	15	2,5	Phase			
07. 136. 02	24,5	8	17,5	2,1	6,4	5	14	15	2,5	Nulleiter			
07. 136. 03	24,5	8	22	2,1	6,4	5	14	22	2,5	Phase			
07. 136. 04	24,5	8	22	2,1	6,4	5	14	22	2,5	Nulleiter			
Reference	Abmessungen - dimensions										Bemerkungen remarks remarques		
a	b	c	d	e	f	g	h	r					
07. 149. 01	25	8	19	4	16	2	3	8	2,5	Nulleiter			
07. 149. 02	25	8	19	4	16	2	3	8	2,5	Phase			
07. 149. 03	25	8	24	4	16	2	3	8	2,5	Nulleiter			
07. 149. 04	25	8	24	4	16	2	3	8	2,5	Phase			
Reference	Abmessungen - dimensions											Bemerkungen remarks remarques	
a	b	c	d	e	f	g	h	L	D				
07. 117. 01	80	25	35	19	50	18	30	14	160	10,5	Rohrschuh 20 x 20		
07. 117. 02	80	25	35	20	50	15	30	13	160	10,5	Quetschkabel- schuh ohne Bügel		
07. 117. 03	80	25	35	16	50	20	-	-	75	9,5			
07. 117. 04	80	25	35	16,5	45	22	-	35	90	-	ohne Bügel		

# Schleifstücke und Kontakte für Kleinschleifleitungen

Reference	Abmessungen - dimensions						Bemerkungen remarks remarques
	a	b	c	d	e	f	
07. 137. 01	40	10	16	6,2	26	43	

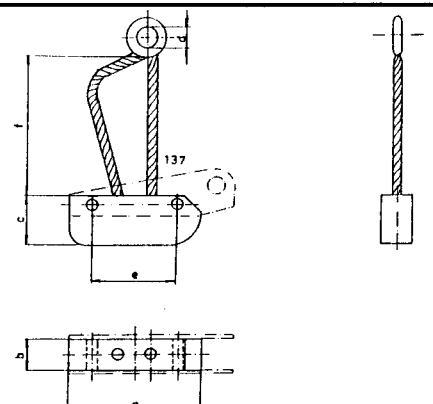

Reference	Abmessungen - dimensions										Bemerkungen remarks remarques
	a	b	c	d	e	f	g	h	r		
07. 139. 01	14	7	15	4,5	1	9	40	8	2		mit je 1 Nut mit je 2 Nuten geschlitzt 2,5 breit
07. 139. 02	14	7	15	4,5	1	9	40	8	2		
07. 139. 03	14	7	15,5	4,3	1	9,5	40	9	-		

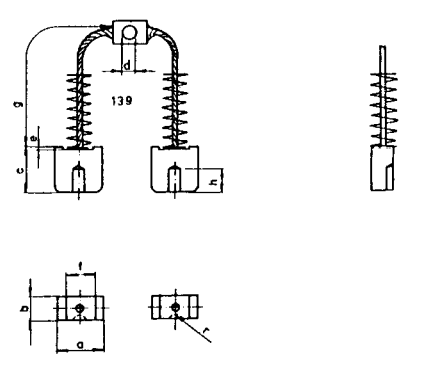

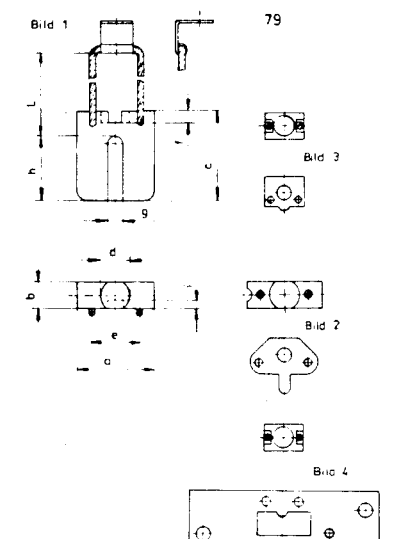
Reference	Abmessungen - dimensions											Bemerkungen remarks remarques
	a	b	c	d	e	f	g	h	i	L	Bild	
07. 79. 01	24	8	27	8,5	14,5	4	5	19,5	2,5	35	1	
07. 79. 02	23	8	24	8,6	23	1,8	5	18	2,5	35	2	
07. 79. 03	12	8	22	6,5	-	1	d=4	15	-	27	3	
07. 79. 04	12	8	24	6	-	3	d=4,2	16	-	30	4	
07. 79. 07	23,3	5,5	24	8	15	2	3	11	-	34	3	

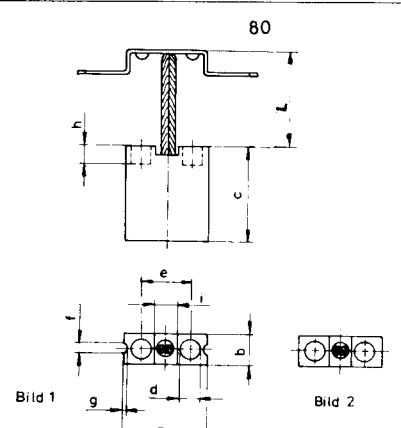
Reference	Abmessungen - dimensions											Bemerkungen remarks remarques
	a	b	c	d	e	f	g	h	i	L	Bild	
07. 80. 01	22,5	8	25	5,5	13,5	3	1	5	6	25	1	
07. 80. 02	23	8	23	5	13,5	-	-	4,5	5,5	22	2	

Reference	Abmessungen - dimensions										Bemerkungen remarks remarques	
	a	b	c	e	f	g	h	i	Bild			
07. 44. 01	20	8	24	3,5	2	17	54	10	1	Nietlasche		
07. 44. 02	20	8	24	3,5	2	17	54	5	1			
07. 44. 03	20	8	24	3,5	2	17	54	5,25	1			
07. 44. 04	20	8	25	3,5	2	17	55	10	2			
07. 44. 06	20	8	25	3,5	2	17	55	5,25	2			
07. 44. 07	20	8	24	3,5	2	17	50	10	1			
07. 44. 08	20	8	25	3,5	2	17	51,5	5,25	2			
07. 44. 08	20	8	25	3,5	2	17	51,5	5,25	2			
Reference	Abmessungen - dimensions							Bemerkungen remarks remarques				
a	b	c	d	e	f	g						
07. 108. 01	36	10	18	8,1	27	24	2,5	Stromleiter Nulleiter				
07. 108. 02	36	10	18	8,1	27	24	2,5					
Reference	Abmessungen - dimensions							Bemerkungen remarks remarques				
a	b	c	i	f	g							
07. 110. 01	36	10	18	8	24	2,5	Stromleiter Nulleiter					
07. 110. 02	36	10	18	8	24	2,5						
Reference	Abmessungen - dimensions							Bemerkungen remarks remarques				
a	b	c	e	r	g	h						
07. 123. 01	8	24,5	23	2,5	2,5	17	32	Bügel				
07. 123. 01	8	24,5	23	2,5	2,5	17	32					
Reference	Abmessungen - dimensions										Bemerkungen remarks remarques	
a	b	c	d	e	f	g	h	r				
07. 147. 01	8	24,5	23	5,2	5	24,5	16	32	2,5	147		
07. 147. 02	8	24,5	19	5,2	5	24,5	15	32	2,5			
07. 147. 03	8	24,5	19	4,3	5	24,5	15	32	2,5			

Reference	Abmessungen - dimensions									Bemerkungen remarks remarques
	a	b	c	e	f	g	h	i	Bild	
07. 100. 01	5	23	24	15	-	-	-	-	1	Fangstift  gleiche Kohle 02 Graphit Marke gleiche Kohle 03 Graphit Marke  Fangstift
07. 100. 02	5,5	23,3	24	16	2,5	2,5	15	1,5	1	
07. 100. 03	5,5	23,3	24	16	2,5	2,5	15	1,5	2	
07. 100. 04	-	-	-	-	-	-	-	-	1	
07. 100. 05	-	-	-	-	-	-	-	-	2	
07. 100. 06	7	23	24	12	-	-	-	-	1	
07. 100. 07	7	23	24	12	-	-	-	-	1	
07. 100. 08	5	23	24	15	-	-	-	-	2	
07. 100. 09	5	23	24	12	-	-	-	-	2	
07. 100. 10	5	22	24	12	-	-	-	-	1	
07. 100. 11	5	22	24	12	-	-	-	-	2	

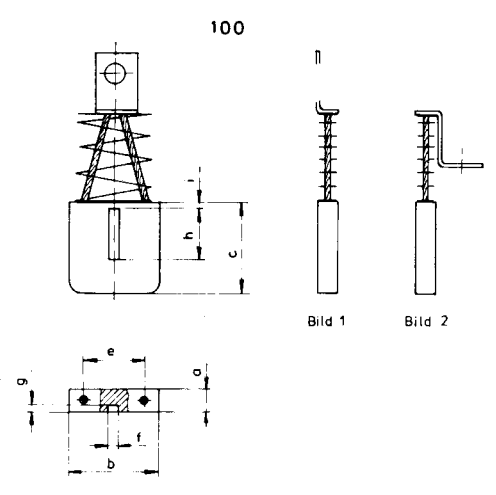

Reference	Abmessungen - dimensions								Bemerkungen remarks remarques
	a	b	c	e	f	g	h	Bild	
07. 109. 01	20	8	25	3,5	2	19,5	51,5	1	109  Bild 1 Bild 2
07. 109. 02	20	8	25	3,5	2	19,5	51,5	2	

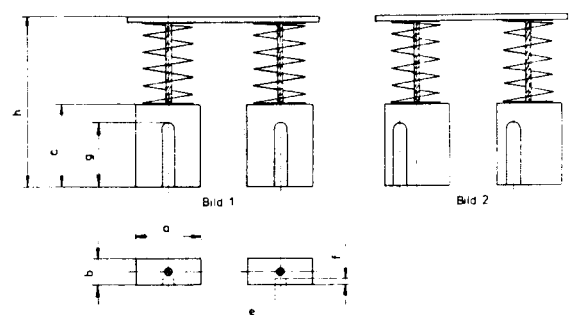

Reference	Abmessungen - dimensions								Bemerkungen remarks remarques
	a	b	c	e	f	g	h	Bild	
07. 114. 01	24	9	25	4,5	2	21,5	48	1	114  Bild 1 Bild 2
07. 114. 02	24,5	12	25	R 2,5	2,5	20	60	2	

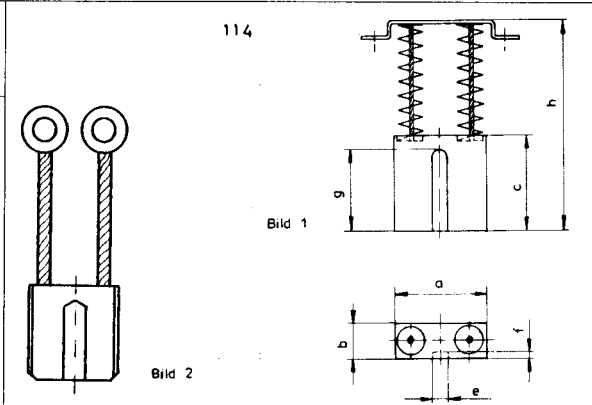

Reference	Abmessungen - dimensions						Bemerkungen remarks remarques
	a	b	c	d	e	f	
07. 127. 01	25	8	19	7	4,5	2,2	127  Bild 1 Bild 2

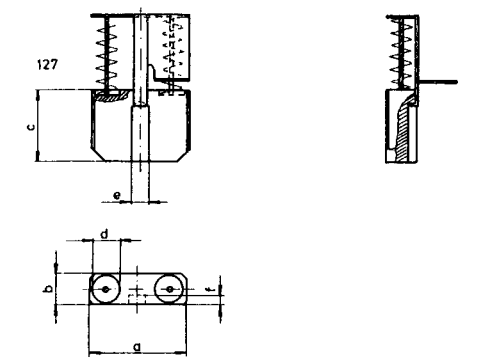



Reference	Abmessungen - dimensions											Bemerkungen remarks remarques
	a	b	c	e	f	g	h	k	r	i	L	
07. 111. 01	5,5	23,3	24	2,6	2,5	1,5	13,5	9	7	11	20	Phase  Erde
07. 111. 02	5,5	23,3	24	2,6	2,5	1,5	13,5	9	7	3	27	

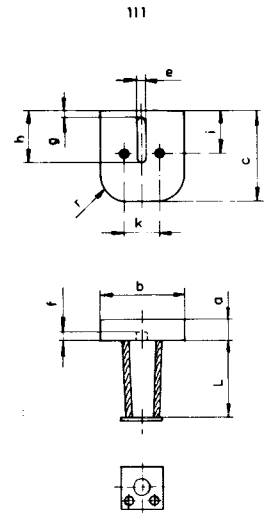

Reference	Abmessungen - dimensions											Bemerkungen remarks remarques
	a	b	c	d	e	f	g	h	L	D	Bild	
07. 49. 01	20	10	25	4,5	5,4	15,5	7,3	3	25	6,3	1	Erde
07. 49. 02	20	10	25	4	3,5	15	3,8	2	70	-	2	
07. 49. 03	20	10	25	4,8	4	20	3,5	2,5	70	-	2	
07. 49. 04	20	10	35	4	3,5	25	3,8	2	80	-	2	Phase
07. 49. 05	20	10	25	4	3,5	15	7,3	2	70	-	2	
07. 49. 06	20	10	25	4,8	4	20	8	2,5	70	-	2	
07. 49. 07	20	10	35	4	3,5	25	8,25	2	80	-	2	
07. 49. 08	20	10	25	4	5	15,5	3	3	23	6,3	1	
07. 49. 09	20	10	28,5	4,5	3,5	24	8,25	2	80	-	2	mit Schuh
07. 49. 10	20	10	28,5	4,6	3,5	24	3,5	2	80	-	2	
07. 49. 11	15	8	25	6	-	-	-	-	57	4,3	-	

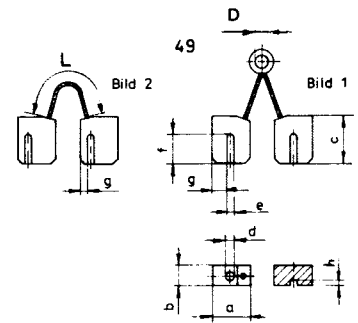

Reference	Abmessungen - dimensions											Bemerkungen remarks remarques
	a	b	c	d	e	f	g	h	i	L		
07. 90. 01	9,5	36	23	2	12,5	6,5	24	5	13	36/29	Endhülse u. Öse d = 6,5 Kabelöse d = 6,5	
07. 90. 02	9,5	36	23	2	12,5	6,5	24	5	13	27,5		

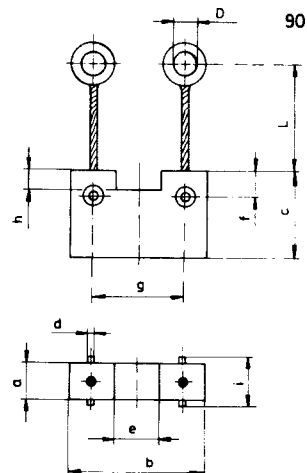

Reference	Abmessungen - dimensions											Bemerkungen remarks remarques	
	a	b	c	d1	e	f	g	h	i	L	D		
07. 125. 01	25	8	20	6,2	15,2	6,5	15	14	10	60	4,6	Kabelöse Kabelöse Kabelöse, Fahnen- schuh Kabelöse, Fahnen- schuh Kabelöse, Fahnen- schuh	
07. 125. 02	25	8	20	6,2	15,2	5	15	14	10	60	4,6		
07. 125. 03	25	8	22	6,2	15,2	6,5	16	16	10	88	4,6		
07. 125. 04	25	8	26	6,2	15,2	6,5	19	16	10	60	4,6		
07. 125. 05	25	8	26	6,2	15,2	5	16	10	10	60	4,6		
07. 125. 06	25	8	22	6,5	15	-	16	-	8,5	72	5,2		

Reference	Abmessungen - dimensions										Bemerkungen remarks remarques	
	a	b	c	d	e	f	g	h	L	Bild		
07. 112. 01	25	8	18,5	6,5	16	5,5	8	11,5	34	1	Cu Einfassung 3°	
07. 112. 02	25	8	18,5	6,2	15,2	5	10	11	31	1	Kabelöse oder Fahnschuh Kabelöse oder Fahnschuh Fangstift d = 3 x 1	
07. 112. 03	25	8	18,5	6,2	15,2	6,5	10	11	45	1		
07. 112. 04	25	8	18,5	6,5	16	5,5	8	11,5	35	2	Schlitz 4x1 ohne Fangstift	
07. 112. 05	25	8	18,5	6,5	16	5,5	8	11,5	35	3		
07. 112. 06	25	8	15,6	6,7	15	5,5	10	11,5	35	3	ohne Fangstift	
07. 112. 07	25	8	15,6	6,7	15	5,5	10	11,5	35	3	ohne Fangstift	
07. 112. 08	25	8	20	6,5	16	5	8	14	35	2	mit Fangstift	
07. 112. 09	25	8	18,5	6,3	15	5,5	10	11	37	2	mit Fangstift, Rohr- schuh	
07. 112. 10	25	8	18,5	6,3	15	5,5	10	11	37	1	ohne Fangstift, Rohrschuh mit Öse	
07. 112. 11	25	8	18,5	6,3	16	7	8	11,5	37	1		

Reference	Abmessungen - dimensions							Bemerkungen remarks remarques	
	a	b	c	d1	d2	f	h		
07. 116. 01	7,95	16,1	19,1	3	6	5,5	5	140	Endhülse isol. braun/schwarz Endhülse isol. grün/gelb isol. grün/gelb isol. schwarz
07. 116. 02	7,95	17,1	19,1	3	6	5,5	5	140	
07. 116. 03	8	27	19	3	6	5,5	5	150	
07. 116. 04	8	26	18	3	6,1	5,5	5	170	

Reference	Abmessungen - dimensions					Bemerkungen remarks remarques	
	a	b	c	e	r		
07. 87. 01	12,3	8,2	19	13	2,5	80	

Reference	Abmessungen - dimensions										Bemerkungen remarks remarques
	a	b	c	d1	d2	e	f	g	L	D	
07. 68. 01	16,5	8	15	10	14	2,5	10	3	30	5	Litze rechts
07. 68. 02	16,5	10	15	10	14	2,5	10	3	30	5	
07. 68. 03	16,5	12	15	10	14	2,5	10	3	35	5	
07. 68. 04	20	10	18	8	10	2,5	12,5	4,5	35	5	
07. 68. 05	17	8	15,5	9,5	14,5	2,5	10,5	2,5	35	5	
07. 68. 06	16,5	8	15	10	14	2,7	10	3	35	5	
07. 68. 07	16,5	10	15	10	14	2,7	10	3	35	5	
07. 68. 08	17	12	15	10	14	2,7	10	3	35	5	
07. 68. 09	16,5	9,8	15	10	14	-	-	3	45	4	
07. 68. 10	16,5	7,8	15	10	14	-	-	3	45	5	
07. 68. 11	16,5	8	15	10	14	2,7	10	3	35	5	
07. 68. 12	16,6	7,8	15	10	14	2,5	10,7	3	33	5,3	
07. 68. 13	16,6	11,9	15	10	14	2,5	10,7	3	33	5,3	
07. 68. 14	16,6	9,8	15	10	14	2,5	10,7	3	33	5,3	

68

Reference	Abmessungen - dimensions								Bemerkungen remarks remarques
	a	b	c	e	f	g	L	D	
07. 93. 01	24,5	8,35	19	5,5	3	15	56	5,3	93
07. 93. 02	25	8	19	4	2	15	45	5,3	

93

Reference	Abmessungen - dimensions								Bemerkungen remarks remarques
	a	b	c	e	f	L	D	Bild	
07. 94. 01	24,6	8,1	19	5,6	2,8	53	4,3	1	94 Bild 2 Bild 1
07. 94. 02	24,6	8,1	19	5,6	2,8	53	4,3	2	
07. 94. 03	24,5	8	19	2,7 r	-	45	4,3	1	
07. 94. 04	24,5	8	19	5	2,5	50	5	2	
07. 94. 05	24,5	8,3	19	5	2,5	50	5	1	

94

Reference	Abmessungen - dimensions											Bemerkungen remarks remarques
	a	b	c	d	e	f	g	h	i	L	D	
07. 78. 01	12,3	13,7	15	8,2	14,5	5	3	5	4,5	22,5	5	links  links links - rechts
07. 78. 02	12,3	13,7	13	8,2	14,5	5	3	5,5	4	24	5,2	
07. 78. 03	12,3	13,7	15	8,2	14,5	5	3	5	4,5	22,5	5	
07. 78. 04	12,3	13,7	13	8,2	14,5	5	3	5,5	4	24	5,2	
07. 78. 05	12,3	13,7	15	8,2	14,5	5	3	5	4,5	22,5	5	
07. 78. 06	12,5	14	13	8,2	14,5	5	3	5,5	4	24	5,2	
07. 78. 07	12,5	14	13	8,2	14,5	5	3	5,5	4	24	5,2	

78

Reference	Abmessungen - dimensions							Bemerkungen remarks remarques
	a	b	c	d	e	f	g	
07. 143. 01	15	12	20	d=6,5	8	5,5	3,5	

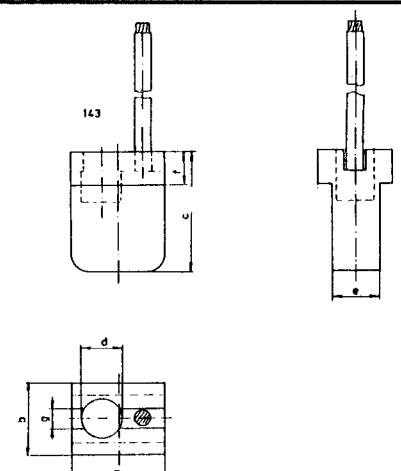

Reference	Abmessungen - dimensions										Bemerkungen remarks remarques
	a	b	c	d	e	f	g	h	i	k	
07. 59. 01	30	12	9	3,5	20	22,5	2	30	28	20	

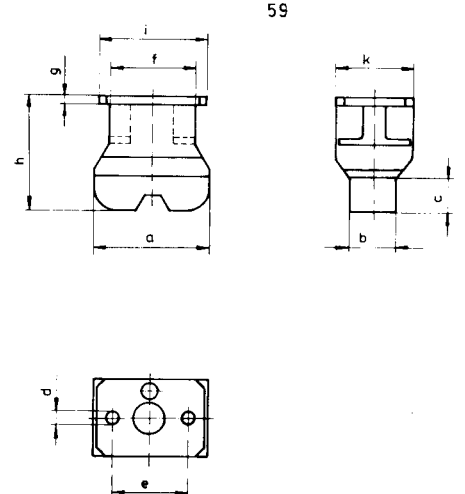

Reference	Abmessungen - dimensions											Bemerkungen remarks remarques	
	a	b	c	d1	d2	e	f	g	h	i	w°		k
07. 71. 01	32	16	18,5	5,2	3,2	8	8	M3	13,5	14,5	100	9,5	

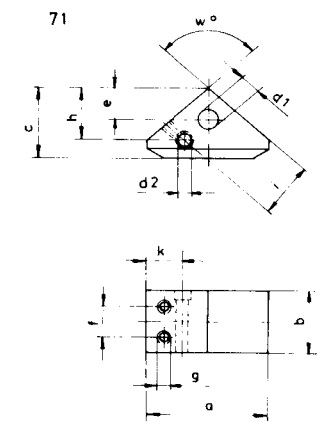

Reference	Abmessungen - dimensions									Bemerkungen remarks remarques
	a	b	c	d	e	f	g	r1	r2	
07. 84. 01	27	10	16,5	4,5	5	4,5	20	5	20	

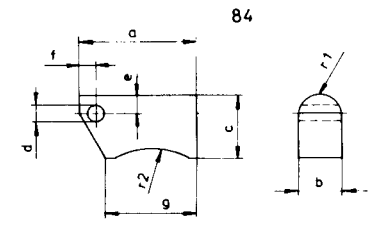

Reference	Abmessungen - dimensions				Bemerkungen remarks remarques
	a	b	c	r	
07. 43. 02	32	15	60	8	

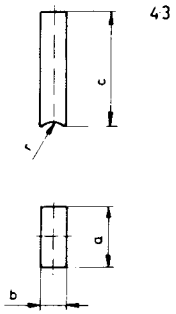

Reference	Abmessungen - dimensions									Bemerkungen remarks remarques
	a	b	c	d	e	f	g	h	i	
07. 48. 01	105	35	23,5	M8	64	29	23	7	98	

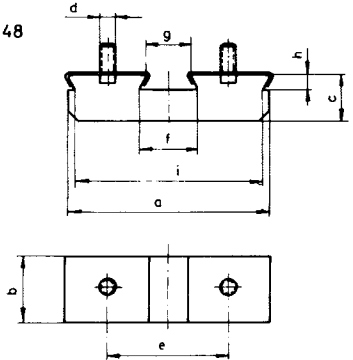

Reference	Abmessungen - dimensions					Bemerkungen remarks remarques
	a	b	c	d	e	
07. 83. 01	6,4	19	13	3,1	10,5	4

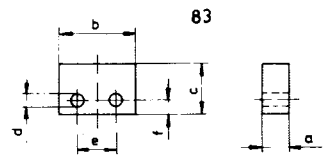

Reference	Abmessungen - dimensions							Bemerkungen remarks remarques
	a	b	c	d	e	r	w°	
07. 124. 01	44	8	13	M4	20	12	60	

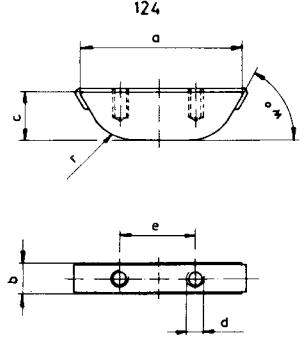

Reference	Abmessungen - dimensions							Bemerkungen remarks remarques	40
	a	b	c	d	r1	r2	Bild		
07. 40. 01	80	65	58	24	250	13,5	1		
07. 40. 02	80	50	29,5	15	-	50	2		

Reference	Abmessungen - dimensions						Bemerkungen remarks remarques	41
	a	b	c	d	h	r		
07. 41. 01	65	30	58	M10	22	15		

Reference	Abmessungen - dimensions								Bemerkungen remarks remarques	42
	a	b	c	d	e	f	h	r		
07. 42. 01	65	30	58	M10	35	25	22	15		

Reference	Abmessungen - dimensions							Bemerkungen remarks remarques	113
	a	b	c	e	f	g	Bild		
07. 113. 01	35	30	20	18	15	1,5	1		
07. 113. 02	30	40	18	18	10	1,5	1		
07. 113. 03	45	30	20	18	31	7	2		
07. 113. 04	35	30	20	18	22	7	2		
07. 113. 05	35	30	18	18	-	-	3		

Reference	Abmessungen - dimensions							Bemerkungen remarks remarques
	a	b	c	d	e	f	r	
05.96.01	25	20	32	M5	9	8	100	

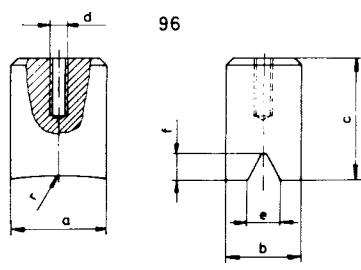

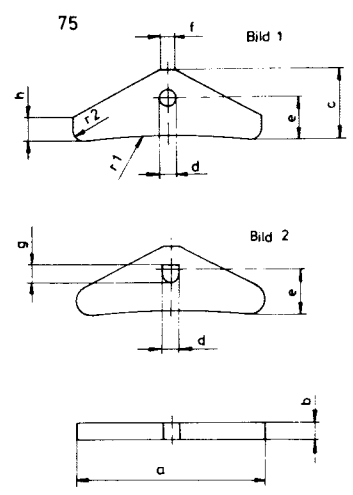
Reference	Abmessungen - dimensions										Bemerkungen remarks remarques
	a	b	c	d	e	f	g	h	r	Bild	
05.75.01	59	4	21	6,4	15	6	5	-	287,5	2	
05.75.02	50	4	18	4	11	4	-	6	284	1	

Reference	Abmessungen - dimensions						Bemerkungen remarks remarques
	a	b	c	e	f	g	
07.99.01	10	14	17	2,5	10	3	

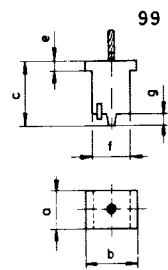

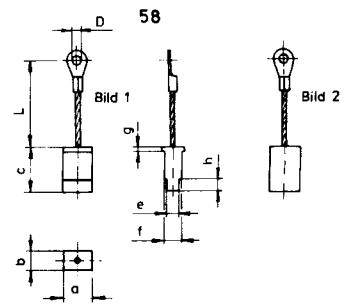
Reference	Abmessungen - dimensions										Bemerkungen remarks remarques
	a	b	c	e	f	g	h	L	D	Bild	
07.58.01	37,5	29,5	43	-	-	-	-	100	6,5	2	
07.58.02	16	11,5	24	7	10	2,5	6	45	3,5	1	
07.58.03	16	11,5	24	-	10	2,5	-	45	3,5	1	

Reference	Abmessungen - dimensions							Bemerkungen remarks remarques
	a	b	c	d	e	f	Bild	
05. 18. 01	d = 5,5	32	44	43	-	-	1	
05. 18. 02	d = 4	36	46	21	5,5	18	2	

Reference	Abmessungen - dimensions							Bemerkungen remarks remarques
	a	b	c	d	e	f	g	
05. 19. 01	10	30	40	6,4	54	18	4	

Reference	Abmessungen - dimensions								Bemerkungen remarks remarques
	a	b	c	d	e	f	g	r	
05. 89. 01	40	40	44	33	6	d = 15	26	150	

Reference	Abmessungen - dimensions					Bemerkungen remarks remarques
	a	c	d	e	f	
05. 90. 01	35	25	10	3	3	



Reference	Abmessungen - dimensions					Bemerkungen remarks remarques
	a	c	d	e	L	
05. 66. 01	16	25,4	9,5	1,5	180	Ende verzinkt

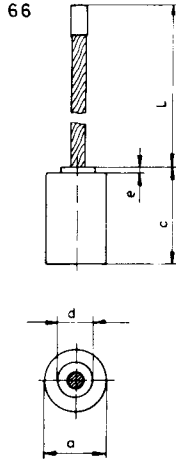

Reference	Abmessungen - dimensions								Bemerkungen remarks remarques
	a	b	c	e	f	d	h	L	
05. 93. 01	30	27	28	19	15	9	10	40	in MS Buchse eingepreßt
05. 93. 02	29,5	27,2	32,5	d = 29,5	12	8	8	57,5	
05. 93. 03	30	27	28	19	15	8	8	50	
05. 93. 04	30	27	28	19	15	9	10	50	

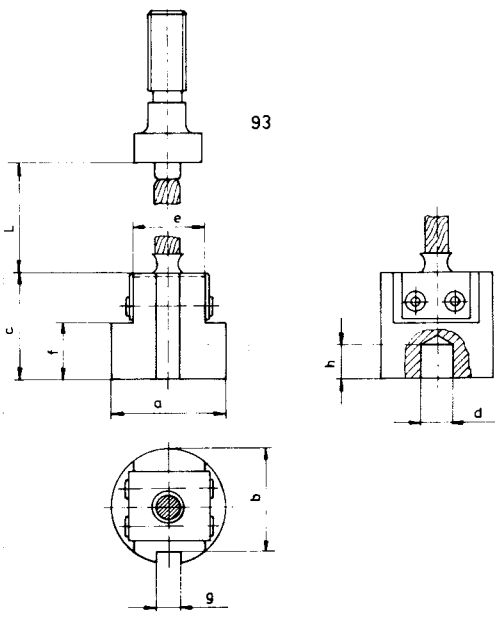

Reference	Abmessungen - dimensions								Bemerkungen remarks remarques
	a	b	c	e	f	d	L	D	
07. 81. 01	27,8	23,8	40	5	12	22,5	210	6,3	Litze 16°

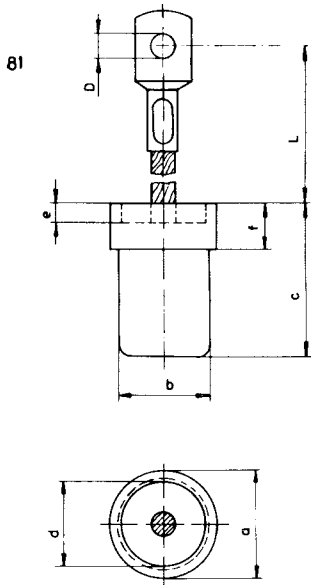

Reference	Abmessungen - dimensions									Bemerkungen remarks remarques	
	a	b	c	e	f	g	L	D	Bild		
05. 65. 01	10	6,4	16,5	5	2,5	4	50	4,2	1		
05. 65. 02	10	6,4	16,5	5	2,5	4	50	4,2	2		

Reference	Abmessungen - dimensions									Bemerkungen remarks remarques	
	a	c	d	e	f	g	h	r	Bild		
05. 79. 01	80	58	M10	30	12	-	-	50	1	Kugelradius Kühlschlitz 3 x 15 Bohrung d = 30x15 Bohrung d = 25x34, Schlitz 9 x 5	
05. 79. 02	80	58	M10	45	15	-	-	87	1		
05. 79. 03	60	22	8,5	40	6,5	14,5	32	130	1		
05. 79. 04	60	30	8,5	40	8	15	32	-	2		
05. 79. 05	60	22	8,5	40	6	-	30	-	1		
05. 79. 06	45	34	-	-	-	9	25	220	3		
05. 79. 07	49,5	30	6	-	24	-	-	111	4		
05. 79. 08	60	22	6,4	44	-	8	30	-	5		
05. 79. 09	60	22	6,4	44	-	8	30	80	5		
05. 79. 10	60	22	6,4	44	-	8	30	90	5		
05. 79. 11	60	22	6,4	44	-	8	30	135	5		
05. 79. 12	60	22	8,5	40	6	8,5	30	-	1		

Reference	Abmessungen - dimensions								Bemerkungen remarks remarques	
	a	c	e	f	g	h	i	Bild		
05. 95. 01	45	38	32,5	32	8,5	-	-	1	1/2 verkupfert	
05. 95. 02	45	38	32,5	-	-	-	-	1	1/2 verkupfert	
05. 95. 03	40	38	35	-	-	31	6	2	Radius	
05. 95. 04	45	38	31,5	-	-	-	-	~1		

Reference	Abmessungen - dimensions				Bemerkungen remarks remarques	
	a	b	c	r		
05. 08. 01	75	42	46	150	Kugelradius 1/2 verk.	
05. 08. 02	66	33	29	161	Kühlschl. 60° versetzt, 6 Gew. M4auf Teilkr. d=50	
05. 08. 03	29	8	16	-		
05. 08. 04	75	42	44,75	150		

Reference	Abmessungen - dimensions								Bemerkungen remarks remarques
	a	b	c	e	f	g	d	Bild	
05. 01. 01	22	12	15	11	15	-	-	1	
05. 01. 02	22	12	15,5	11	15	-	-	1	
05. 01. 03	22	12	12	11	13,5	-	-	1	
05. 01. 04	35	15	19	17,5	17,5	-	-	1	
05. 01. 05	40	22	17,2	20	15,2	-	-	1	
05. 01. 07	35	15	15	10	-	7,5	-	2	
05. 01. 08	33	10	10	8	-	5	-	2	
05. 01. 09	40	22	18	20	16	6	-	1	

Reference	Abmessungen - dimensions								Bemerkungen remarks remarques
	a	b	c	e	f	g	h	d	
05. 92. 01	25	14	19	35	10	45	10	5	
05. 92. 02	20	20	23,5	34	10	46,5	11	5	
05. 92. 03	60	18	33	78	18	94	12,5	6,4	

Reference	Abmessungen - dimensions								Bemerkungen remarks remarques
	a	b	c	d	e	f	r	Bild	
05. 05. 01	24	15	10	M5	8	3	7	1	<p>Größe der Befestigungsschrauben z.B. M5 x 15 bei Bestellung angeben.</p>
05. 05. 02	20	14	13	M6	6	3	10	3	
05. 05. 03	31	25	13,5	1/4 "	11	3	15,5	3	
05. 05. 06	31	15	13,5	1/4 "	11	3	15,5	3	
05. 05. 07	31	15	13,5	1/4 "	8	3	15,5	3	
05. 05. 08	31	20	13,5	1/4 "	11	3	15,5	3	
05. 05. 09	31	12	13,5	1/4 "	11	3	15,5	3	
05. 05. 10	15,5	12	6	3/16 "	5	3	8	3	
05. 05. 11	20	10	11	3/16 "	8	3	10	3	
05. 05. 12	28	11	15	M5	10	-	9	1	
05. 05. 13	28	20	15	M6	10	-	9	1	
05. 05. 14	28	26	15	M6	10	-	9	1	
05. 05. 15	24	20	12	M5	8	-	6	1	<p>05</p>
05. 05. 16	24	12	12	M5	8	-	6	1	
05. 05. 17	28	25	15	M6	10	-	9	3	
05. 05. 18	28	10	13	M5	10	3,5	9,5	3	
05. 05. 19	24	15	10	M5	8	3,5	11,5	1	
05. 05. 20	24	20	10	M5	8	3	10	3	

Kohlekontakte für Schalter, Schütze und Aufzüge

Reference	Abmessungen - dimensions								Bemerkungen remarks remarques
	a	b	c	d	e	f	g	r	
07. 141. 01	14,3	12,5	12,5	1	3,5	2,5	3	8	

Reference	Abmessungen - dimensions								Bemerkungen remarks remarques
	a	b	c	d	e	f	r	Bild	
05. 06. 01	28	25	13	M6	10	3	5	1	<p>Größe der Befestigungsschrauben z.B. M5 x 15 bei Bestellung angeben.</p> <p>Bild 1</p> <p>Bild 2</p>
05. 06. 02	28	15	13	M6	10	3	5	1	
05. 06. 03	26	20	14	M5	10,5	3	5	1	
05. 06. 04	24	15	13	M5	10	3,5	5	1	
05. 06. 05	24	12	12,5	M5	12	4	-	2	
05. 06. 06	24	20	12	M5	8	3	5	1	
05. 06. 07	26	14	15	M5	10,5	3	5	1	
05. 06. 08	20	12	10	M4	5	3	-	2	
05. 06. 09	24	15	10	M5	8	3	8	1	
05. 06. 11	28	12	13	M6	10	3	5	1	
05. 06. 12	24	12	15,5	M5	12,5	3	6	1	
05. 06. 13	24	30	13	M6	10	3	8	1	
05. 06. 14	24	25	13	M5	10	3,5	20	1	
05. 06. 15	28	15	13,5	1/4"	11,5	3	11	1	
05. 06. 16	28	20	13,5	1/4"	11,5	3	11	1	
05. 06. 17	28	25	13	M6	10	3,5	9	1	
05. 06. 18	24	15	13	M4	10	3,5	9	1	
05. 06. 19	28	19	17	M6	10	3	6	1	
05. 06. 20	24	20	13	M6	10	3	8	1	
05. 06. 21	24	25	13	M6	10	3	8	1	

Reference	Abmessungen - dimensions							Bemerkungen remarks remarques
	a	b	c	d	e	f	Bild	
05. 44. 01	20	20	10,5	M5	8	8	1	<p>Kontakt Radius</p> <p>Bild 1</p> <p>Bild 2</p>
05. 44. 02	23	20	12	M5	8,5	r6	1	
05. 44. 03	20	20	11	M5	8,5	8	1	
05. 44. 04	21	20	15	M5	8,5	7	2	
05. 44. 05	20	20	12	M5	8,5	7,5	1	

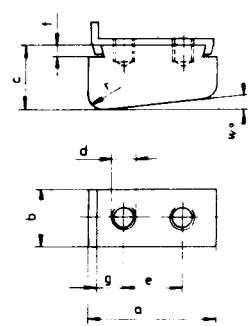
Reference	Abmessungen - dimensions								Bemerkungen remarks remarques	
	a	b	c	d	e	f	g	w°		
05. 82. 01	34	15	17	M6	16	3	7	6		
05. 82. 02	34	8	22	M5	16	3	7	6		
05. 82. 03	42	16	18	M6	16	5	-	6		

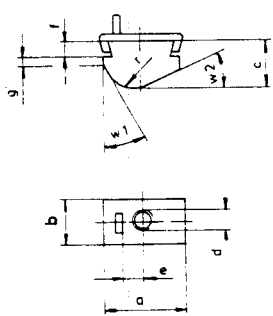

Reference	Abmessungen - dimensions							Bemerkungen remarks remarques	
	a	b	c	d	e	f	r		
05. 07. 01	22	12	13	M5	6	4,5	8		

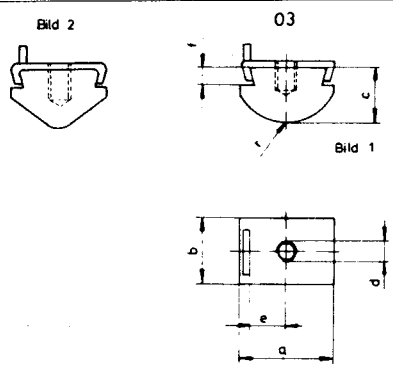

Reference	Abmessungen - dimensions								Bemerkungen remarks remarques	
	a	b	c	d	e	f	r	Bild		
05. 03. 01	20	20	14,5	M6	8	4,5	10	1		
05. 03. 02	20	15	14,5	M6	8	5	10	1		
05. 03. 03	25	15	12	M5	10	6,5	22	1		
05. 03. 04	25	18	15	M6	10	5	14	1		
05. 03. 05	25	12	13	M6	10	5	14	1		
05. 03. 06	25	20	16	M6	8,5	5	5	2		

Reference	Abmessungen - dimensions						Bemerkungen remarks remarques	
	a	b	c	e	f	r		
05. 77. 01	13,5	12	5	2,5	6	20		

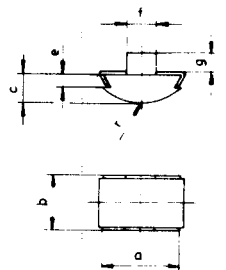
Reference	Abmessungen - dimensions								Bemerkungen remarks remarques	
	a	b	c	d	e	f	r	Bild		
05. 04. 01	30	12	13,5	M4	19	5	11	1	1 Bohrung mittig	
05. 04. 02	21	20	13	M6	-	3,5	-	2		
05. 04. 03	35	25	15,5	M4	18	5	12	2		
05. 04. 04	20	16	10	M5	-	4	2	2		
05. 04. 05	35	30	15,5	M5	18	5	12	2		
05. 04. 06	16	14	10	M4	-	4	2	2		
05. 04. 07	25	15	16	M5	-	8	10	1		
05. 04. 08	15,8	14	10	M4	-	3,5	2	2		

### Kohlekontakte für Schalter, Schütze und Aufzüge

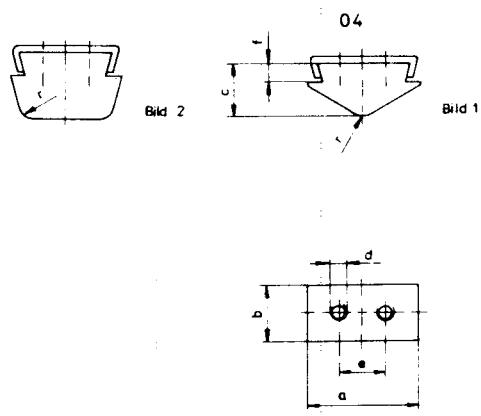
Reference	Abmessungen - dimensions							Bemerkungen remarks remarques
	a	b	c	d	e	f	r	
05. 10. 01	20	15	15	M6	8	3,5	5	Befestigungs- schrauben z.B. M5 x 15 Größe und Ausführ- ung bei Bestellung angeben.
05. 10. 02	25	12	15	M5	9	4,5	9	
05. 10. 03	25	20	20	M6	9	4,5	6	
05. 10. 04	26	20	20	M6	11	4	10	
05. 10. 05	27	25	15	M6	9	6	9	
05. 10. 06	11	8,5	7	M3	4,5	-	11	
05. 10. 07	27	20	15	M6	15	6	6	
05. 10. 08	26	12	12	M5	8	4	6	
05. 10. 09	18	12	19	M4	7	4	5	
05. 10. 10	20	20	11,2	M5	6	3	5	
05. 10. 11	26	15	12	M5	8	4	6	
05. 10. 12	26	20	12	M5	8	4,5	6	
05. 10. 13	35	15	15	M6	13	5	25	
05. 10. 14	27	24	15	M6	11	6	6	
05. 10. 15	17,7	14	9	M4	9	4	5	
05. 10. 16	22	10	12	M5	8	4	8	
05. 10. 17	30	16	12	M5	11	4,5	10	
05. 10. 18	33	20	20	M6	12	5	10	
05. 10. 19	26	25	12	M5	9	5,5	7,5	

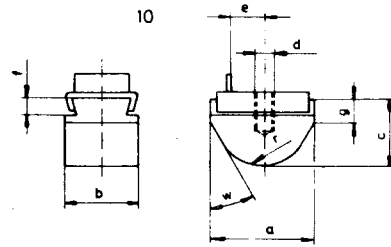

Reference	Abmessungen - dimensions							Bemerkungen remarks remarques
	a	b	c	d	e	r	Bild	
05. 28. 01	19	12,7	14,7	M6	3,5	10	1	MS Schraube M6 x 15
05. 28. 02	22,22	14,28	9,92	M5	4	11,5	1	MS Schraube M5 x 15
05. 28. 03	25,4	12,7	12,5	M5	4	13	1	MS Schraube M5 x 15
05. 28. 04	25,4	19,05	11,5	M5	4	13	1	MS Schraube M5 x 15
05. 28. 05	31,75	15,87	14,28	M6	4	16	1	MS Schraube M6 x 15
05. 28. 06	22,22	19,05	9,52	M5	4	11	1	MS Schraube M5 x 10
05. 28. 07	25,4	25,4	12,7	M5	4	12,5	1	MS Schraube M5 x 15
05. 28. 08	31,75	15,87	16,5	M5	4,6	16	1	MS Schraube M5 x 17
05. 28. 09	15	14	9	M5	4	3,5	2	MS Schraube M5 x 15
05. 28. 10	19,05	12,7	8,73	M5	3,5	10	1	
05. 28. 11	22	12,7	13	M5	4	11	1	
05. 28. 12	31,75	14	13	M5	4	16,5	1	
05. 28. 13	32	19	16	M5	4	16	1	
05. 28. 14	12,7	9,5	12,5	M5	4	6,5	1	
05. 28. 15	32	12,7	15	M5	4	16	1	
05. 28. 16	15,87	12,7	12,7	5/16"	5	-	2	

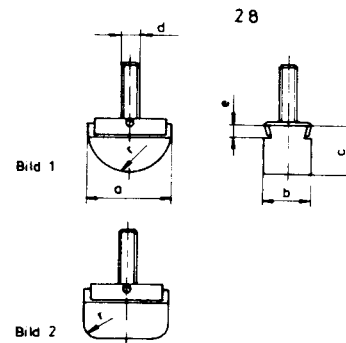

Reference	Abmessungen - dimensions								Bemerkungen remarks remarques
	a	b	c	d	e	f	g	r	
05. 27. 01	12,7	9,5	12	M4	4	10	9	6,5	

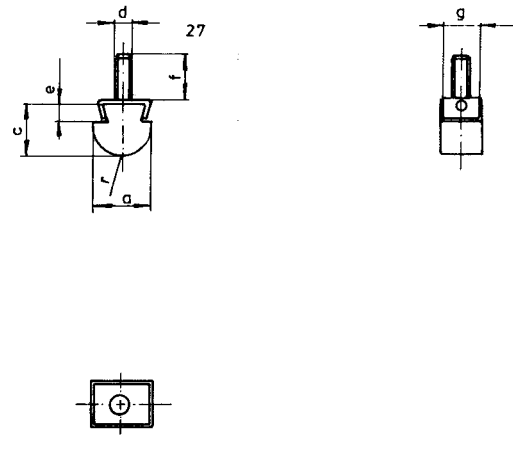

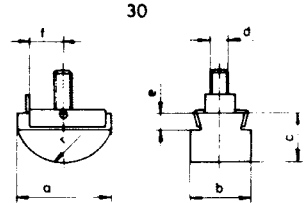
Reference	Abmessungen - dimensions								Bemerkungen remarks remarques
	a	b	c	d	e	f	g	r	
05. 30. 01	23,5	15	13	M5	4,5	9	11,5		
05. 30. 02	25,4	12,5	12	M5	4,5	9	12,5		
05. 30. 03	25,4	16	12,7	M5	4	9	13,5		
05. 30. 04	19,1	12,7	11	M5	4,5	6,5	9		
05. 30. 05	17,5	16	5,5	M5	9	2,5	20		
05. 30. 06	25,4	19,5	12,7	M5	4	9	13,5		

Reference	Abmessungen - dimensions								Bemerkungen remarks remarques
	a	b	c	d	e	f	g	r	
05. 31. 01	24	25	11	M5	5	8	12	6	

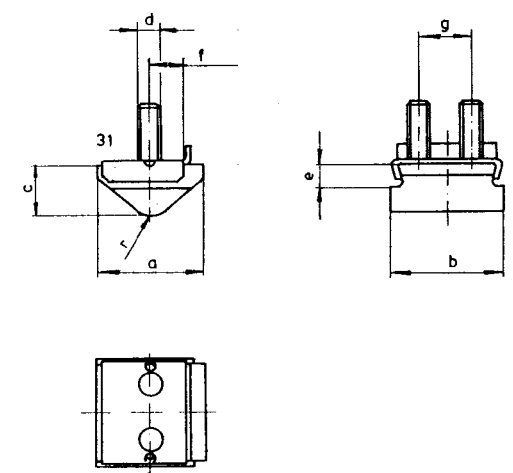

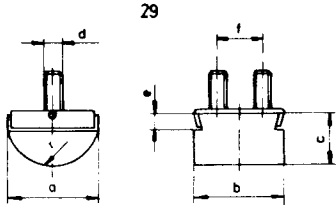
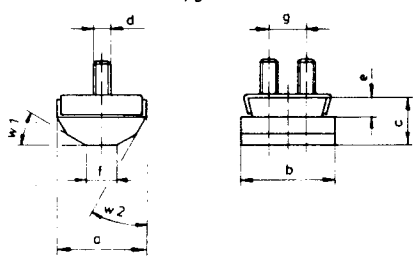
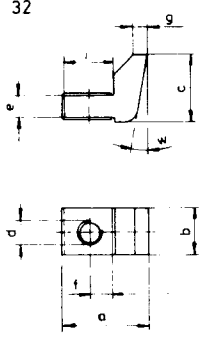
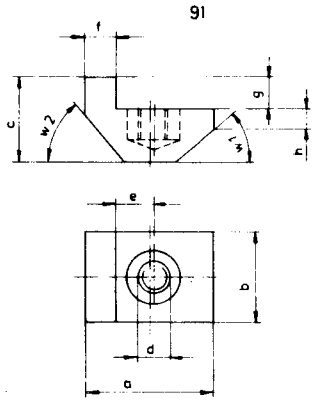
Reference	Abmessungen - dimensions						Bemerkungen remarks remarques			
	a	b	c	d	e	r				
05. 29. 01	25,5	25,5	13	M5	4,5	12,5		 <p>29</p>		
Reference	Abmessungen - dimensions							Bemerkungen remarks remarques		
	a	b	c	d	e	f	g			
05. 70. 01	25,5	25,5	11	M5	5	8,5	12		 <p>70</p>	
Reference	Abmessungen - dimensions								Bemerkungen remarks remarques	
	a	b	c	d	e	f	g	i		
05. 32. 01	22,8	12	17	M6	6	6,5	4	13	Blecheinfassung	 <p>32</p>
Reference	Abmessungen - dimensions								Bemerkungen remarks remarques	
	a	b	c	d	e	f	g	h		
05. 91. 01	17	12	11	M4	5	4	4	2,5	Gew.Buchse eingelötet	 <p>91</p>



Reference	Abmessungen - dimensions									Bemerkungen remarks remarques
	a	b	c	d	e	f	g	r	h	
05. 72. 01	23	13	13	M5	7	3,5	3,5	7	9	

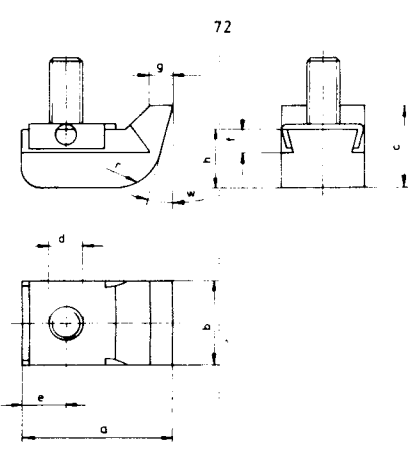

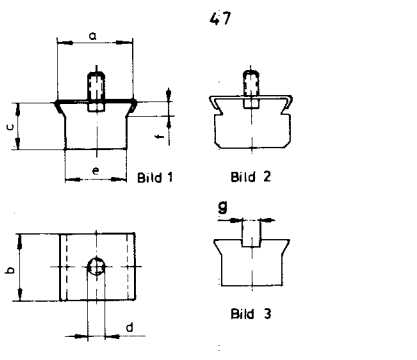
Reference	Abmessungen - dimensions								Bemerkungen remarks remarques
	a	b	c	d	e	f	g	Bild	
07. 47. 01	40	35	23,5	M8	33	8	-	1	
07. 47. 02	41	35	23,5	M8	41	7	-	2	
07. 47. 05	39	35	23,5	-	33	8	10	3	

Reference	Abmessungen - dimensions							Bemerkungen remarks remarques
	a	b	c	d	e	f	r1	
05. 13. 01	32	12	15,5	M5	16	8	13	MS Gew.Einlage
05. 13. 02	24	12	14	M4	11	10	18	
05. 13. 03	50	8	25	M3	25	-	25	

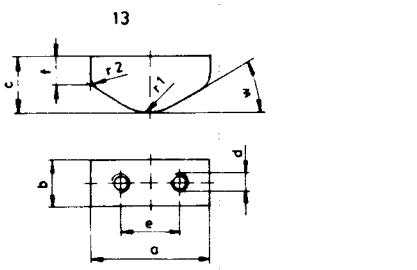

Reference	Abmessungen - dimensions						Bemerkungen remarks remarques
	a	a1	b	c	r	r1	
05. 26. 01	9,5	7,2	8,4	5,2	5	3,75	

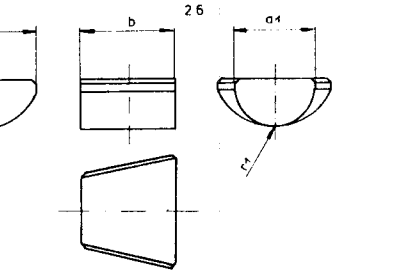

Reference	Abmessungen - dimensions							Bemerkungen remarks remarques
	a	b	c	d	e	f	g	
05. 73. 01	32	10	17	3,2	13	3,5	7,5	Winkel <sup>o</sup> bei Bestellung angeben Halterung für den Kontakt extra bestellen

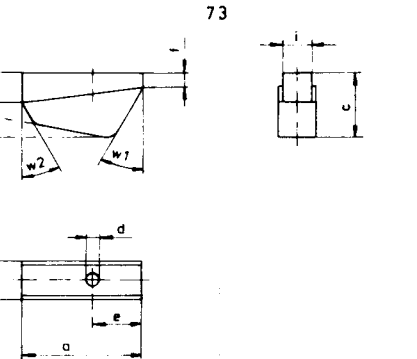

Kohlekontakte für Schalter, Schütze und Aufzüge

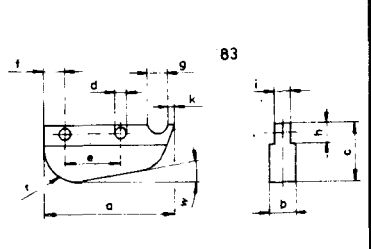
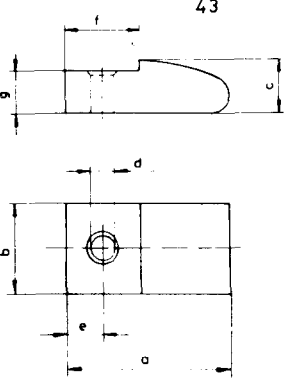
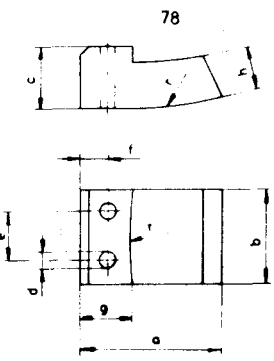
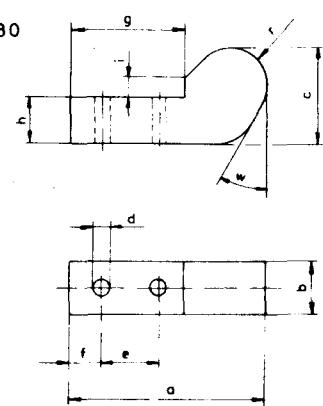
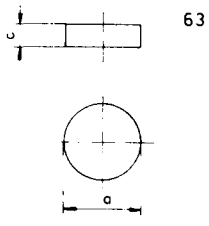
Reference	Abmessungen - dimensions												Bemerkungen remarks remarques	
	a	b	c	d	e	f	g	h	i	k	r	w		
05. 83. 01	40,5	8	17	3,2	17	6	5,5	6	5	2	10	10		
Reference	Abmessungen - dimensions							Bemerkungen remarks remarques						
	a	b	c	d	e	f	g							
05. 43. 01	44	24	14	6	10	20	11							
05. 43. 02	47	24	21	5,7	9	8,5	15							
Reference	Abmessungen - dimensions									Bemerkungen remarks remarques				
	a	b	c	d	e	f	g	h	r					
05. 78. 01	38	25	16	4,5	13	7	14	12	100	verk.				
Reference	Abmessungen - dimensions											Bemerkungen remarks remarques		
	a	b	c	d	e	f	g	h	i	r	w			
05. 80. 01	52	14	25	4,5	15	8,5	30	12	5	10	30			
Reference	Abmessungen - dimensions		Bemerkungen remarks remarques											
	a	c												
05. 63. 01	12	4												

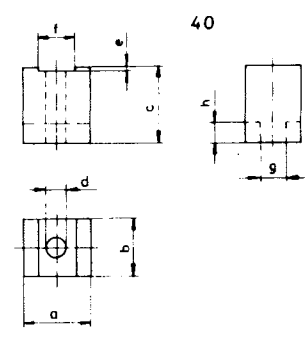
Reference	Abmessungen - dimensions								Bemerkungen remarks remarques
	a	b	c	d	e	f	g	h	
05. 40. 01	18	15	20	5,3	1	10	-	-	Stirnfl. verk.  
05. 40. 02	20	15	20	5,6	1,5	10,5	-	-	
05. 40. 03	18	10	15	4,7	1,5	10,5	-	-	
05. 40. 04	25	20	25	6,3	2	15	-	-	
05. 40. 05	18	10	15	4,5	1,7	10,5	15	6	
05. 40. 06	25	18	20	5,2	1	10	-	-	
05. 40. 07	27	20	25	6,3	2	15,2	-	-	

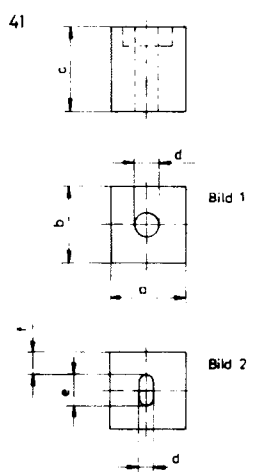
Reference	Abmessungen - dimensions							Bemerkungen remarks remarques
	a	b	c	d	e	f	Bild	
05. 41. 01	19	19	19	6,5	-	-	1	Sackloch d = 6,5x7 Gew. M4 Kont. fl. verk.  
05. 41. 02	10	10	20	M4	-	-	1	
05. 41. 03	42	42	20	6	-	-	1	
05. 41. 04	32	20	32	5	15	8,5	2	
05. 41. 05	30	15	30	4	7	5	2	
05. 41. 06	20	10	19	4,5	-	-	1	
05. 41. 07	20	10	13	4,5	-	-	1	
05. 41. 08	30	15	30	4	10	10	2	

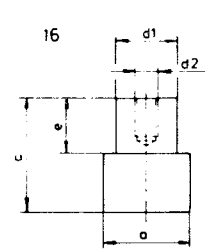
Reference	Abmessungen - dimensions					Bemerkungen remarks remarques
	a	c	e	d1	d2	
05. 16. 01	16	14	8	12	-	verk.  
05. 16. 02	45	60	29	32	1/2"	

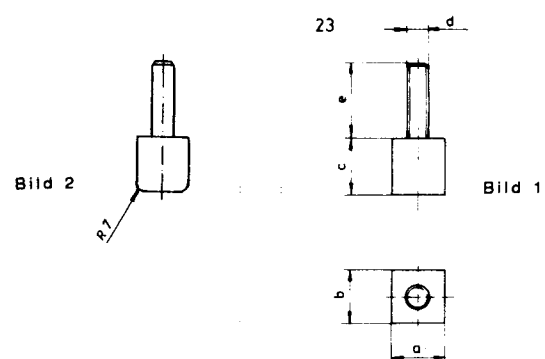
Reference	Abmessungen - dimensions						Bemerkungen remarks remarques
	a	b	c	e	d	Bild	
05. 23. 01	14	14	15	20	M6	1	verk.  
05. 23. 02	30	30	24	10	M12	2	

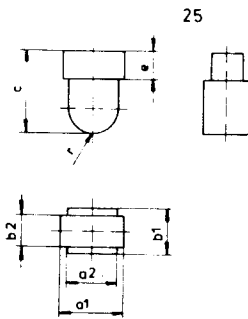
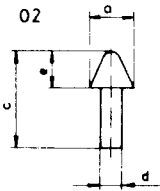
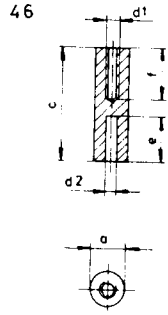
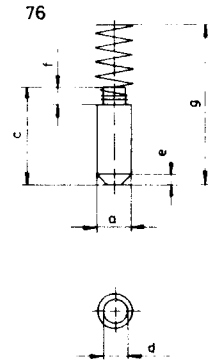
Reference	Abmessungen - dimensions							Bemerkungen remarks remarques	
	a1	a2	b1	b2	c	e	r		
05. 25. 01	16,5	13	8,5	12	21,5	7,5	6,5		 <p>25</p>
Reference	Abmessungen - dimensions				Bemerkungen remarks remarques				
	a	c	d	e					
05. 02. 01	11,5	25,5	5,95	9,5		 <p>02</p>			
05. 02. 02	8,5	23	5,95	7					
Reference	Abmessungen - dimensions						Bemerkungen remarks remarques		
	a	c	d1	d2	e	f			
05. 46. 01	9	30	M4	3,5	12	14	 <p>46</p>		
05. 46. 02	9	30	M4	-	-	14			
Reference	Abmessungen - dimensions						Bemerkungen remarks remarques		
	a	c	d	e	f	g			
05. 76. 01	d=3	8,5	1,7	1	1,5	14	o.A., o.F.	 <p>76</p>	
05. 76. 02	2,9	11,5	-	0,47	-	-			
05. 76. 03	d=3	8,5	-	1	1,5	14			

Reference	Abmessungen - dimensions			Bemerkungen remarks remarques
	D	d	B	
05. 201. 01	15	4	8	
05. 201. 02	15	4	10	
05. 201. 03	20	6	10	
05. 201. 04	25	6	10	
05. 201. 05	25	6	15	
05. 201. 06	30	6	15	
05. 201. 07	35	6	15	

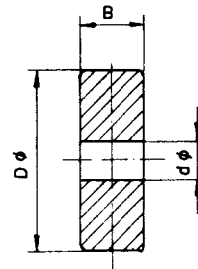

Reference	Abmessungen - dimensions			Bemerkungen remarks remarques
	D	d	B	
05. 202. 01	15	4	8	mit Sinterlager
05. 202. 02	15	4	10	mit Sinterlager
05. 202. 03	20	6	10	mit Sinterlager
05. 202. 04	25	6	10	mit Sinterlager
05. 202. 05	25	6	15	mit Sinterlager
05. 202. 06	30	6	15	mit Sinterlager
05. 202. 07	35	6	15	mit Sinterlager

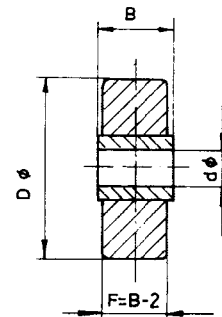

Reference	Abmessungen - dimensions			Bemerkungen remarks remarques
	D	d	B	
05. 203. 01	15	4	8	mit Cu-Laufbuchse und MS-Scheiben
05. 203. 02	15	4	10	mit Cu-Laufbuchse und MS-Scheiben
05. 203. 03	20	6	10	mit Cu-Laufbuchse und MS-Scheiben
05. 203. 04	25	6	10	mit Cu-Laufbuchse und MS-Scheiben
05. 203. 05	25	6	15	mit Cu-Laufbuchse und MS-Scheiben
05. 203. 06	30	6	15	mit Cu-Laufbuchse und MS-Scheiben
05. 203. 07	35	6	15	mit Cu-Laufbuchse und MS-Scheiben

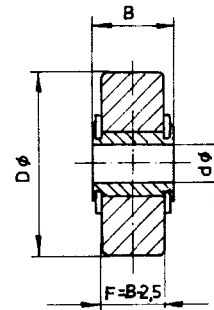

Reference	Abmessungen - dimensions			Bemerkungen remarks remarques
	D	d	B	
05. 204. 01	15	4	8	mit Cu-Rohrmiet und Sinterlager
05. 204. 02	15	4	10	mit Cu-Rohrmiet und Sinterlager
05. 204. 03	20	6	10	mit Cu-Rohrmiet und Sinterlager
05. 204. 04	25	6	10	mit Cu-Rohrmiet und Sinterlager
05. 204. 05	25	6	15	mit Cu-Rohrmiet und Sinterlager
05. 204. 06	30	6	15	mit Cu-Rohrmiet und Sinterlager
05. 204. 07	35	6	15	mit Cu-Rohrmiet und Sinterlager

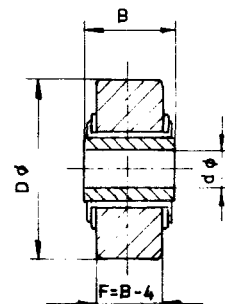

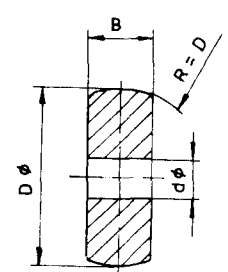
Reference	Abmessungen - dimensions				Bemerkungen remarks remarques
	D	d	B	R	
05.205.01	15	4	8		
05.205.02	15	4	10		
05.205.03	20	6	10		
05.205.04	25	6	10		
05.205.05	25	6	15		
05.205.06	30	6	15		
05.205.07	35	6	15		
05.205.08	20	5	8		
05.205.09	20	7,7/5,7	8	8	

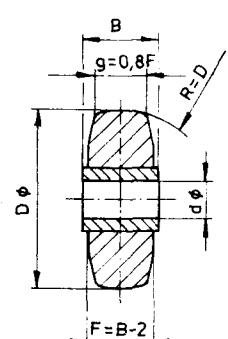
Reference	Abmessungen - dimensions			Bemerkungen remarks remarques	
	D	d	B		
05.206.01	15	4	8	mit Sinterlager	
05.206.02	15	4	10	mit Sinterlager	
05.206.03	20	6	10	mit Sinterlager	
05.206.04	25	6	10	mit Sinterlager	
05.206.05	25	6	15	mit Sinterlager	
05.206.06	30	6	15	mit Sinterlager	
05.206.07	35	6	15	mit Sinterlager	
05.206.08	37	6	15	mit Sinterlager	

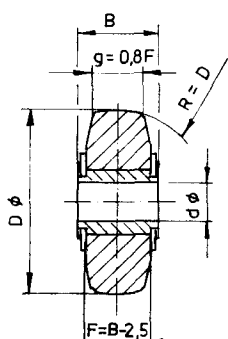
Reference	Abmessungen - dimensions			Bemerkungen remarks remarques	
	D	d	B		
05.207.01	15	4	8	mit Cu-Laufbuchse und MS-Scheiben	
05.207.02	15	4	10		
05.207.03	20	6	10		
05.207.04	25	6	10		
05.207.05	25	6	15		
05.207.06	30	6	15		
05.207.07	35	6	15		

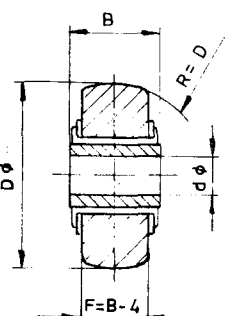
Reference	Abmessungen - dimensions			Bemerkungen remarks remarques	
	D	d	B		
05.208.01	15	4	8	mit Cu-Rohrniet und Sinterlager	
05.208.02	15	4	10		
05.208.03	20	6	10		
05.208.04	25	6	10		
05.208.05	25	6	15		
05.208.06	30	6	15		
05.208.07	35	6	15		
05.208.08	25	6	15		

Reference	Abmessungen - dimensions						Bemerkungen remarks remarques
	D	d1	d2	B	f	r	
05. 209. 01	18	5	10	10	8	24	mit Bund
05. 209. 02	25	6	12	15	12	26	
05. 209. 03	30	6	12	11	10	20	
05. 209. 04	12	4	6	4,5	4	12	
05. 209. 05	20	4	8	8	6	20	
05. 209. 06	12	5	6	4,5	4	12	
05. 209. 07	15	5,05	7	10	8	15	+ 2 Bohrungen
05. 209. 08	32	6,1	12	12,5	10	-	
05. 209. 09	32	6	12	12,5	10	40	
05. 209. 10	40	6	12	15	12	-	
05. 209. 11	28	6	12	11	10	-	
05. 209. 12	60	30	50	30	18	35	

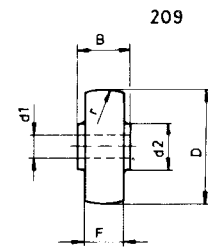

Reference	Abmessungen - dimensions				Bemerkungen remarks remarques
	D	d1	B	r	
05. 210. 01	11	3,2	4	20	
05. 210. 02	11	3,2	4	20	

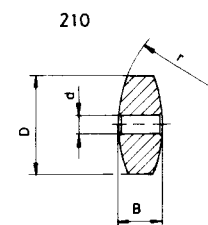

Reference	Abmessungen - dimensions							Bemerkungen remarks remarques
	D	d1	d2	d3	B	F	r	
05. 211. 01	38	6	10	30	15	11	50	seitl. Scheiben Sinterlager

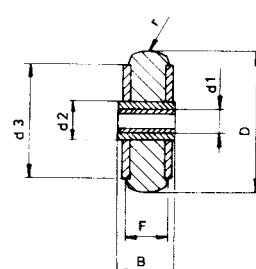

Reference	Abmessungen - dimensions				Bemerkungen remarks remarques
	D	d	B	F	
05. 212. 01	30	6	24	10,5	seitl. Scheiben mit fester Achse

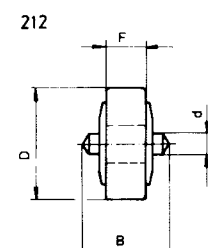

Reference	Abmessungen - dimensions						Bemerkungen remarks remarques
	a	b	c	d	e	f	
05. 213. 01	40	37	11	8	13	4	

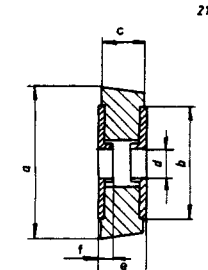

## REFERENCE - TABELLE

Reference	Seite	Reference	Seite	Reference	Seite	Reference	Seite
07. 01. xx	7	07. 45. xx	3	07. 93. xx	32	07. 136. xx	26
07. 02. xx	1	07. 46. xx	34	07. 94. xx	32	07. 137. xx	27
07. 03. xx	8	07. 49. xx	30	07. 95. xx	12	07. 138. xx	23
07. 04. xx	9/10	07. 50. xx	5	07. 96. xx	4	07. 139. xx	27
07. 05. xx	1	07. 53. xx	22	07. 97. xx	13	07. 140. xx	6
07. 06. xx	2	07. 54. xx	12	07. 99. xx	36	07. 141. xx	41
07. 07. xx	10	07. 55. xx	12	07. 100. xx	29	07. 142. xx	21
07. 08. xx	10	07. 56. xx	16	07. 101. xx	26	07. 143. xx	33
07. 09. xx	11	07. 58. xx	36	07. 102. xx	22	07. 144. xx	25
07. 10. xx	11	07. 59. xx	33	07. 103. xx	23	07. 145. xx	24
07. 11. xx	11	07. 60. xx	5	07. 104. xx	4	07. 146. xx	24
07. 12. xx	8	07. 61. xx	5	07. 105. xx	25	07. 147. xx	28
07. 13. xx	13	07. 63. xx	5	07. 106. xx	20	07. 149. xx	26
07. 14. xx	14	07. 64. xx	17	07. 107. xx	21	07. 150. xx	23
07. 15. xx	4	07. 65. xx	5	07. 108. xx	28		
07. 16. xx	14	07. 67. xx	6	07. 109. xx	29	P 0	18
07. 17. xx	11	07. 68. xx	32	07. 110. xx	28	P 4	18
07. 18. xx	3	07. 70. xx	3	07. 111. xx	30	P 5	18
07. 19. xx	3	07. 71. xx	33	07. 112. xx	31	P 10	18
07. 20. xx	17	07. 72. xx	19	07. 113. xx	35		
07. 21. xx	18	07. 73. xx	24	07. 114. xx	29		
07. 22. xx	18	07. 74. xx	17	07. 115. xx	26		
07. 23. xx	18	07. 75. xx	6	07. 116. xx	31		
07. 26. xx	12	07. 76. xx	25	07. 117. xx	26		
07. 27. xx	4	07. 77. xx	25	07. 118. xx	19		
07. 28. xx	15	07. 78. xx	32	07. 120. xx	8		
07. 29. xx	2	07. 79. xx	27	07. 121. xx	3		
07. 31. xx	19	07. 80. xx	27	07. 122. xx	19		
07. 32. xx	2	07. 81. xx	38	07. 123. xx	28		
07. 34. xx	2	07. 82. xx	7	07. 124. xx	34		
07. 37. xx	20	07. 83. xx	34	07. 125. xx	31		
07. 38. xx	24	07. 84. xx	33	07. 126. xx	4		
07. 39. xx	24	07. 85. xx	21	07. 127. xx	29		
07. 40. xx	35	07. 86. xx	25	07. 128. xx	13		
07. 41. xx	35	07. 87. xx	31	07. 129. xx	10		
07. 42. xx	35	07. 88. xx	22	07. 130. xx	16		
07. 43. xx	34	07. 89. xx	20	07. 131. xx	23		
07. 44. xx	28	07. 90. xx	30	07. 134. xx	21		



















Reference	Seite
05. 01. xx	40
05. 02. xx	48
05. 03. xx	42
05. 04. xx	42
05. 05. xx	40
05. 06. xx	41
05. 07. xx	42
05. 08. xx	39
05. 10. xx	43
05. 13. xx	46
05. 16. xx	48
05. 18. xx	37
05. 19. xx	37
05. 23. xx	48
05. 25. xx	49
05. 26. xx	46
05. 27. xx	44

Reference	Seite
05. 28. xx	43
05. 29. xx	45
05. 30. xx	44
05. 31. xx	44
05. 32. xx	45
05. 40. xx	48
05. 41. xx	48
05. 43. xx	47
05. 44. xx	41
05. 46. xx	49
05. 63. xx	47
05. 65. xx	39
05. 66. xx	38
05. 70. xx	45
05. 72. xx	46
05. 73. xx	46
05. 75. xx	38

Reference	Seite
05. 76. xx	49
05. 77. xx	42
05. 78. xx	47
05. 79. xx	39
05. 80. xx	47
05. 82. xx	42
05. 83. xx	47
05. 89. xx	37
05. 90. xx	37
05. 91. xx	45
05. 92. xx	40
05. 93. xx	38
05. 95. xx	39
05. 96. xx	36

Reference	Seite
05. 201. xx	50
05. 202. xx	50
05. 203. xx	50
05. 204. xx	50
05. 205. xx	51
05. 206. xx	51
05. 207. xx	51
05. 208. xx	51
05. 209. xx	52
05. 210. xx	52
05. 211. xx	52
05. 212. xx	52
05. 213. xx	52



01	Industriekohlebürsten Industrial Carbon Brushes Balais Industriels Escobillas Industriales	
02	Kleinkohlebürsten Midget Carbon Brushes Petit Balais Escobillas pequenos	
03	Mikrokohlebürsten Micro Brushes Micro Balais Escobillas miniatura	
04	Autokohlebürsten Automotive Carbon Brushes Balais pour Automobiles Escobillas para Automóviles	
05	Kohlekontakte – Kohlerollen Carbon Contacts and Rolls Contacts et Roulettes Contactos y Rodillos	
06	Hochstromkohlen High-current Carbon Brushes Balais à Courant fort Escobillas para Corriente alta	
07	Kohle-Schleifstücke Carbon Inserts Frotteurs en Charbon Insertos de Carbón	
08	Kohle-Formteile Carbon Profiles Profils en Charbon Elementos Perfilados	
09	Pumpenschieber Carbon Vanes Vannes de Pompes Corredera de Bombe	
10	Schmierkohlen Graphite Lubricating Brushes Balais Lubrifiants Escobillas de Lubricación	
11	Kohlelager Carbon Bearings Coussinets Cojinetos de Carbón	
12	Thermistoren – PTC/NTC Thermistors Thermistances Termistores	
13	Spezialarmaturen für Bürsten Special Armatures for Brushes Armatures spéciales pour Balais Guarniciones particulares	
14	Flexible Cu-Leiter u. Verbindungen Flexible Copper Conductors Conducteurs Flexibles en Cuivre Conexiones Flexibles de Cobre	
15	Kohleschweißstäbe u. Lötstifte Carbon Welding Rods Electrodes de Soudure en Charbon Electrodos para Soldadura al Carbono	
16	Kohlebürsten für Flurförderzeuge Carbon Brushes for Fork Lifts Balais pour Chariots de Manutention Escobillas para Carretillas de Manutención	

Lieferprogramm-  
Sammelliste

Range  
of Products

Gamme  
de Fabrication

Programa  
de Fabricacion



**SCHMIDTHAMMER  
ELEKTROKOHLE GMBH**

Walpersdorfer Straße 33-39  
D-8540 Schwabach/Nürnberg

West-Germany

Telefon 091 22/85041

Telex 624 968 mega d

Telefax 091 22/85725

**07-1990**