

Parallel grippers HGPT, HGPL and Three-point grippers HGDT

FESTO

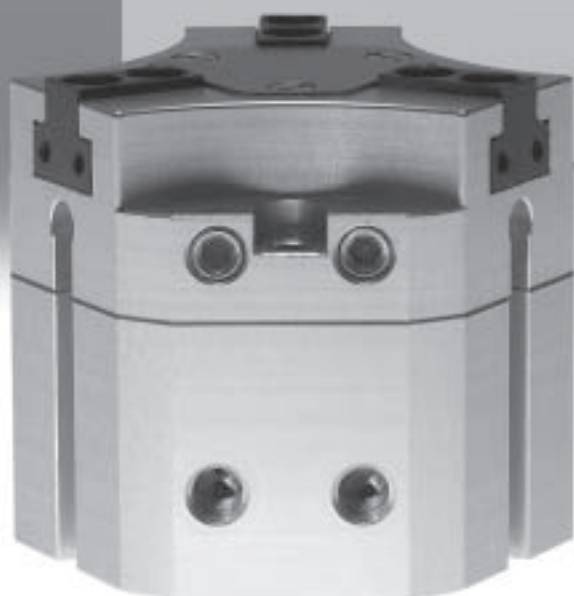

Heavy-duty grippers
for mechanical engineering

Info 139

HGPT, HGPL, HGDT: sturdy, reliable and versatile



HGPT: for sturdy parallel gripping

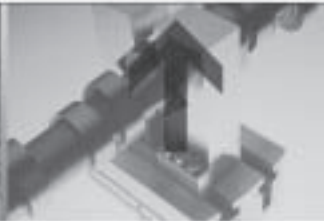

HGPL: ideal for long strokes



HGDT: very high load capacity

3 grippers – 1 convincing concept

Space-saving design

Low-cost SM...-10 proximity sensors are fully integrated into the housing.

Team players

Free and easy combination with a wide range of drives from the Festo modular handling system, for example slides, handling axes and rotary drives.

Simple choice

Easy selection and sizing thanks to the software tool available with the digital catalogue.

Sturdy

Can cope with very high forces and torsional loads thanks to precision ground and paired T-slots. The HGPT and HGDT use sealing air to protect against the ingress of soluble oil and dust.

Versatile

Mounting options on different sides permit maximum freedom in design. Gripping force retention, for example in the case of multiple gripping of plates, further increases flexibility: for single-acting operation, two or more grippers can be installed more quickly.

Reliable

HGPT and HGDT are ideal for dynamic applications: thanks to gripping force retention, the grippers hold the workpiece securely in the event of a pressure drop. If more gripping force is needed for the gripping process, the spring force adds to the gripping force – there is no need to choose the next gripper size!

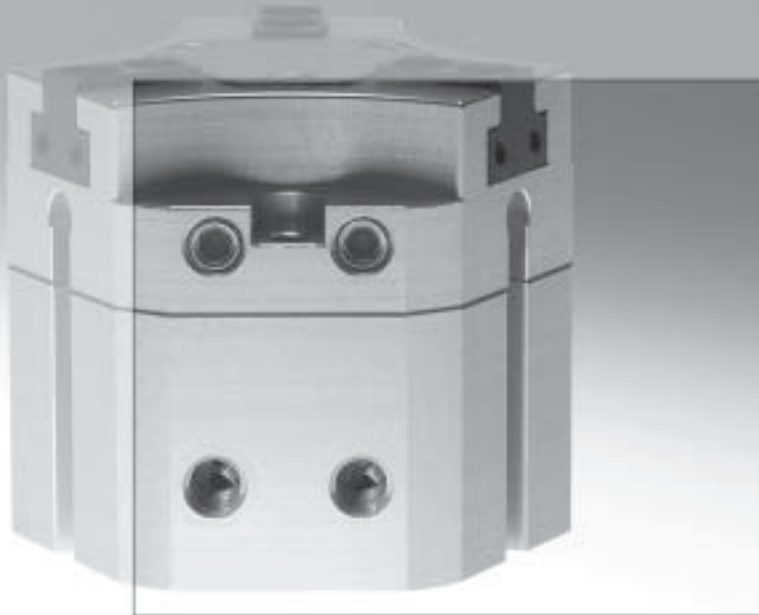

	Advantages for designers	Advantages for purchasers
High gripping forces and high load capacity	<ul style="list-style-type: none"> Reliable, even under the most difficult operating conditions 	<ul style="list-style-type: none"> Reduced follow-up costs through long service life Excellent value for money
Sturdy housing with integrated sensor slots	<ul style="list-style-type: none"> Reliable sensing via low-cost slot fitting sensors Easy installation of the sensors High process reliability, as there are no switch lugs protruding from the housing Maintenance-free operation under normal conditions Very easy maintenance under difficult operating conditions 	<ul style="list-style-type: none"> Cost savings through low wear and long service life Low-cost sensing option using standard proximity sensors SM...-10
Fully compatible with the modular handling and assembly system	<ul style="list-style-type: none"> Quick and easy system integration thanks to clearly defined interfaces 	<ul style="list-style-type: none"> Everything from a single source means reduced logistics
Demand-driven, customer-specific solutions	<ul style="list-style-type: none"> Inductive sensors for gripper jaw sensing and heat-resistant designs in the case of HGPT and HGDT Single-acting design for gripping force retention or gripping force support in the case of HGPL 	<ul style="list-style-type: none"> Festo offers the right technical solution for virtually every application at the most economical price

HGPT, HGPL and HGDT:
giving you a threefold advantage



HGPT



HGPL



HGDT

Forces at the gripper

Basic principles

Calculation tools for determining gripping force

What is meant by gripping force?

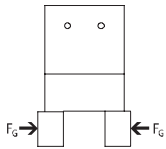

Action = Reaction
The gripping force F_G refers to the gripping force per gripper jaw.

When selecting a gripper you need to determine the gripping force required to hold a workpiece of mass m [kg]

and move this workpiece at an acceleration of a [m/s^2].

How does the gripping force act in the case of 2-jaw grippers?

Parallel, radial and angle grippers

Mechanical locking

	$F_G = m \times (g + a) \times S$
--	-----------------------------------

F_G Required gripping force [N] per gripper jaw

For angle and radial grippers, gripping force F_G must be converted to gripping torque M_G .

r, x Distance between the gripper zero point and the gripping point (lever arm)

→ Catalogue specifications: "Gripping force as a function of the lever arm"

$$M_G = F_G \times r$$

m Workpiece mass [kg]

g Acceleration due to gravity ($\approx 10 m/s^2$) is required if acting against the acceleration a

a Acceleration [m/s^2] arising from the dynamic movement

S Safety factor

Mechanical locking with V-gripper

	$F_G = \frac{m \times (g + a)}{2} \times \tan \alpha \times S$
	$F_G = m \times (g + a) \times \tan \alpha \times S$

Frictional locking

	$F_G = \frac{m \times (g + a)}{2 \times \mu} \times \sin \alpha \times S$
--	---

α Angle of V-gripper finger

μ Coefficient of friction between gripper finger and workpiece

How does the gripping force act in the case of 3-jaw grippers?

Three-point gripper

Mechanical locking

	$F_G = m \times (g + a) \times S$
--	-----------------------------------

Mechanical locking with V-gripper

	$F_G = \frac{m \times (g + a)}{3} \times \tan \alpha \times S$
--	--

Frictional locking

	$F_G = \frac{m \times (g + a)}{3 \times \mu} \times S$
--	--

Forces at the gripper

Basic principles

Max. acceleration values with different drive types

Peak acceleration values occur:

- In an emergency stop
- Shortly before the end position is reached

Drive function	Pneumatic			Servopneumatic	Electrical		
	with fixed cushioning	with adjustable cushioning	with shock absorber		Axis with toothed belt	Axis with spindle	with linear motor
Max. acceleration [m/s ²]	50 ... 300	10 ... 300	10 ... 300	5 ... 15	0 ... 15	0 ... 6	0 ... 30

Recommended safety factor

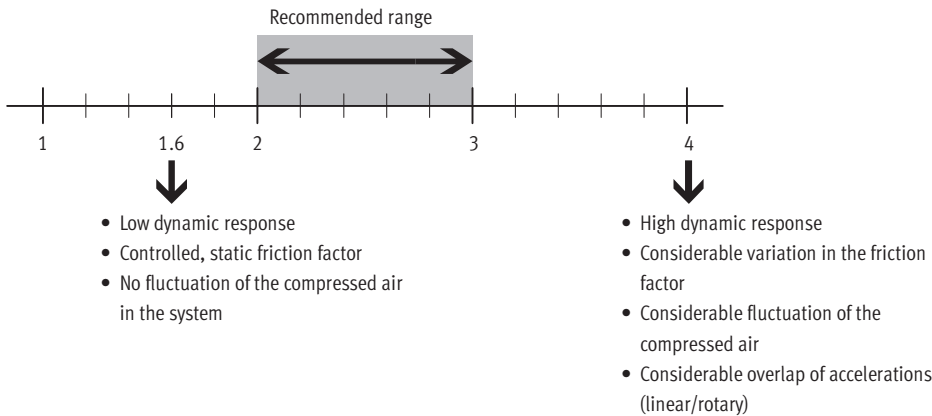

Coefficient of friction μ

		Workpiece surface				
		ST	STL	AL	ALI	R
Gripper finger surface	ST	0.25	0.15	0.35	0.20	0.50
	STL	0.15	0.09	0.21	0.12	0.30
	AL	0.35	0.21	0.49	0.28	0.70
	ALI	0.20	0.12	0.28	0.16	0.40
	R	0.50	0.30	0.70	0.40	1.00

ST Steel
 STL Lubricated steel
 AL Aluminium
 ALI Lubricated aluminium
 R Rubber

Limits of this analysis

Eccentricity of the centre of gravity of the mass referred to the gripping point

- Graphs with grippers in the catalogue
- In the electronic catalogue

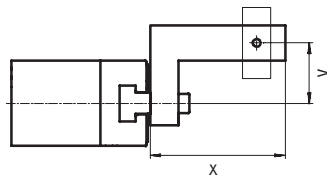

Calculation program in the electronic catalogue on CD-ROM



Optimum entry of

- Workpiece and gripper finger geometry
- Direction of motion, dynamic response
- Coefficient of friction, pressure, temperature and safety factor



Parallel gripper

Selection aid

FESTO

-  - Note

1) The workpiece mass has been calculated based on the gripping principle "Positive locking with V-gripper" using the variable values specified below.

→ 4:





- Parallel gripper

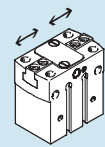
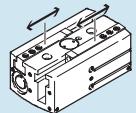

- Variable values:
 - $a = 50 \text{ m/s}^2$
 - $g + a = 60 \text{ m/s}^2$
 - $\alpha = 45^\circ$
 - $\tan \alpha = 1$
 - S and x → Workpiece mass

2) Possible applications:

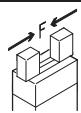
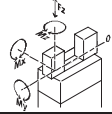
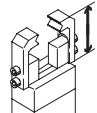
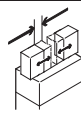

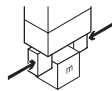







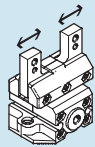
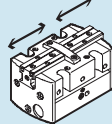
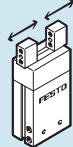
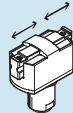



- Workpiece retention in case of loss of compressed air
- As a single-acting gripper
- Acts to increase gripping force

Selection criteria/gripper types			
	Parallel gripper HGPT 	Parallel gripper HGPL 	
Workpiece mass ¹⁾ [kg]			
	Up to 12 kg S = 2 x = 40 mm	Up to 9.7 kg S = 2 x = 40 mm	
Gripping force (external gripping) [N] at 6 bar			
	F per gripper jaw		
	36 ... 770	80 ... 605	
	F total		
	72 ... 1 540	160 ... 1 210	
Maximum permissible characteristic load values per gripper jaw			
	Fz [N]	4 000	2 500
	Mx [Nm]	140	125
	My [Nm]	120	80
	Mz [Nm]	80	100
Gripper finger length [mm]			
	Max. 180	Max. 135	
Gripper stroke per gripper jaw [mm]			
	3 ... 16 	40 ... 80 	
Repetition accuracy [mm]			
	≤ 0.04	≤ 0.03	
Gripping force retention ²⁾ , opening and closing			
	■	-	
Proximity sensors/sensors for position sensing at the gripper			
	■	■	
Advantages			
	<ul style="list-style-type: none"> - Sturdy T-slot - Sealing air - Integrated sensors 	<ul style="list-style-type: none"> - Sturdy T-slot - Adjustable opening stroke - Integrated sensors 	
Technical data and dimensions			
Further information	→ 12	→ 26	

Parallel gripper

Selection aid

FESTO

Selection criteria/gripper types			
Parallel gripper HGPC	Precision parallel gripper HGPP	Parallel gripper HGP	Micro-parallel gripper HGPM
			
Workpiece mass ¹⁾ [kg]			
Up to 1.05 kg S = 3 x = 40 mm	Up to 6.7 kg S = 2 x = 40 mm	Up to 3.4 kg S = 3 x = 40 mm	Up to 0.17 kg S = 3 x = 10 mm
			
Gripping force (external gripping) [N] at 6 bar			
F per gripper jaw			
22 ... 63	40 ... 415	10 ... 350	8 ... 14
F total			
44 ... 126	80 ... 830	20 ... 700	16 ... 28
			
Maximum permissible characteristic load values per gripper jaw			
120	720	380	30
5	50	25	0.5
5	50	25	0.5
5	50	25	0.5
Gripper finger length [mm]			
Max. 60	Max. 160	Max. 100	Max. 30
			
Gripper stroke per gripper jaw [mm]			
3 ... 7 	2 ... 12.5 	2 ... 12.5 	2 ... 3 
Repetition accuracy [mm]			
≤ 0.05	≤ 0.02	≤ 0.04	≤ 0.05
Gripping force retention ²⁾ , opening and closing			
■	■	■	–
Proximity sensors/sensors for position sensing at the gripper			
■	■	■	–
Advantages			
<ul style="list-style-type: none"> – Cost-effective – Integrated sensors 	<ul style="list-style-type: none"> – High precision thanks to gripper jaw with ball bearing guide – Integrated sensors – 3 positions can be sensed 	<ul style="list-style-type: none"> – Dust-protected variant: HGP-16/-25...-SSK – Cost-effective – Integrated sensors 	<ul style="list-style-type: none"> – Single-acting – Compact
Technical data and dimensions			
➔ Info 154	➔ Info 157	➔ Info 116	➔ Info 116

Parallel gripper

Selection aid

FESTO

-  - Note

1) The workpiece mass has been calculated based on the gripping principle "Positive locking with V-gripper" using the variable values specified below.

→ 4:



- Parallel gripper



- Variable values:
 - $a = 50 \text{ m/s}^2$
 - $g + a = 60 \text{ m/s}^2$
 - $\alpha = 45^\circ$
 - $\tan \alpha = 1$
 - S and x → Workpiece mass

2) Possible applications:

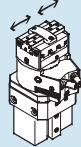
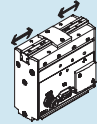
- Workpiece retention in case of loss of compressed air
- As a single-acting gripper
- Acts to increase gripping force

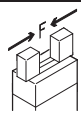
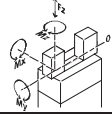
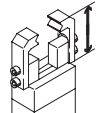
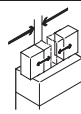
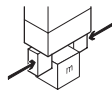
Selection criteria/gripper types			
	Swivel/gripper unit HGDS 	Precision proportional parallel gripper HGPP1 	
Workpiece mass ¹⁾ [kg]			
	Up to 1.2 kg S = 2 x = 40 mm	Up to 1 kg S = 2 x = 40 mm	
Gripping force (external gripping) [N] at 6 bar			
	F per gripper jaw		
	26 ... 65	10 ... 60 (adjustable)	
	F total		
	52 ... 130	20 ... 120 (adjustable)	
Maximum permissible characteristic load values per gripper jaw			
	Fz [N]	60	70
	Mx [Nm]	8	3
	My [Nm]	8	3
	Mz [Nm]	8	3
Gripper finger length [mm]			
	Max. 70	Max. 70	
Gripper stroke per gripper jaw [mm]			
	2.5 ... 7 ↔	Swivel angle 0 ... 210° ↻	0 ... 10 ↔↔ Can be positioned freely and independently
Repetition accuracy [mm]			
	≤ 0.02	≤ 0.02	
Gripping force retention ²⁾ , opening and closing			
	-	-	
Proximity sensors/sensors for position sensing at the gripper			
	■	Absolute displacement encoder	
Advantages			
	- Swivelling and gripping in one unit - Compact - Integrated sensors	- Gripper jaws can be positioned freely and independently - High precision thanks to gripper jaw with ball bearing guide	
Technical data and dimensions			
Further information	→ Info 135	→ Info 157	

Three-point gripper

Selection aid

- Note





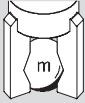

1) The workpiece mass has been calculated based on the gripping principle "Positive locking with V-gripper" using the variable values specified below.

→ 4:

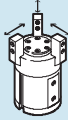
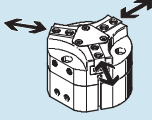
- Three-point gripper

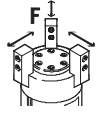

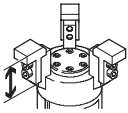
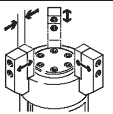
- Variable values:
 - $a = 50 \text{ m/s}^2$
 - $g + a = 60 \text{ m/s}^2$
 - $\alpha = 45^\circ$
 - $\tan \alpha = 1$
 - S and $r \rightarrow$ Workpiece mass

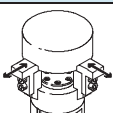
Selection criteria/gripper types			
	Three-point gripper HGD 	Three-point gripper HGDT 	
Workpiece mass ¹⁾ [kg]			
	Up to 3.8 kg $S = 3$ $x = 40 \text{ mm}$	Up to 12.7 kg $S = 2$ $x = 40 \text{ mm}$	
Gripping force (external gripping) [N] at 6 bar			
	F per gripper jaw		
	30 ... 300	70 ... 550	
	F total		
	90 ... 900	210 ... 1 650	
Maximum permissible characteristic load values at the gripper jaw			
	Fz [N]	170	2 500
	Mx [Nm]	5	80
	My [Nm]	8	50
	Mz [Nm]	5	60
Gripper finger length [mm]			
	Max. 100	Max. 140	
Gripper stroke per gripper jaw [mm]			
	2.5 ... 6 	3 ... 10 	
Repetition accuracy [mm]			
	≤ 0.04	≤ 0.03	
Gripping force retention			
	-	■	
Proximity sensors/sensors for position sensing at the gripper			
	■	■	
Advantages			
	- Simple, position-centred gripping of perfectly round parts - Integrated sensors	- Sturdy T-slot - Sealing air - Integrated sensors	
Technical data and dimensions			
Further information	→ Info 116	→ 42	

Radial gripper

Selection aid

-  - Note





1) The workpiece mass has been calculated based on the gripping principle "Positive locking with V-gripper" using the variable values specified below.

→ 4:

- Radial grippers

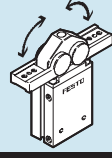

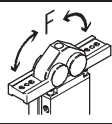
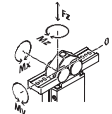
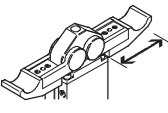
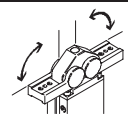
- Variable values:
 - $a = 50 \text{ m/s}^2$
 - $g + a = 60 \text{ m/s}^2$
 - $\alpha = 45^\circ$
 - $\tan \alpha = 1$
 - s and $r \rightarrow$ Workpiece mass

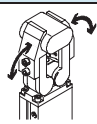
Selection criteria/gripper types									
Radial gripper HGR									
Workpiece mass ¹⁾ [kg]									
	Up to 1 kg S = 3 r = 30 mm								
Total gripping torque (external gripping) [Ncm] at 6 bar									
	13 ... 500								
Maximum permissible characteristic load values at the gripper jaw									
	<table border="1"> <tr><td>Fz [N]</td><td>80</td></tr> <tr><td>Mx [Nm]</td><td>2</td></tr> <tr><td>My [Nm]</td><td>10</td></tr> <tr><td>Mz [Nm]</td><td>7</td></tr> </table>	Fz [N]	80	Mx [Nm]	2	My [Nm]	10	Mz [Nm]	7
Fz [N]	80								
Mx [Nm]	2								
My [Nm]	10								
Mz [Nm]	7								
Gripper finger length [mm]									
	Max. 120								
Gripping angle per gripper jaw [°]									
	-1 ... +90 								
Repetition accuracy [mm]									
	≤ 0.1								
Gripping force retention									
	-								
Proximity sensors/sensors for position sensing at the gripper									
	■								
Advantages									
	<ul style="list-style-type: none"> - Linear axes can be avoided - Integrated sensors 								
Technical data and dimensions									
Further information	→ Info 116								

Angle gripper

Selection aid

Note







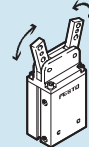

1) The workpiece mass has been calculated based on the gripping principle "Positive locking with V-gripper" using the variable values specified below.

→ 4:

- Angle gripper

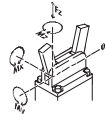
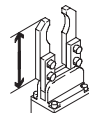
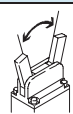

- Variable values:
 - $a = 50 \text{ m/s}^2$
 - $g + a = 60 \text{ m/s}^2$
 - $\alpha = 45^\circ$
 - $\tan \alpha = 1$
 - S and $r \rightarrow$ Workpiece mass

Selection criteria/gripper types		
	Angle gripper HGW	Micro-angle gripper HGWM
		
Workpiece mass ¹ [kg]		
	Up to 2 kg $S = 3$ $r = 30 \text{ mm}$	Up to 0.2 kg $S = 3$ $r = 20 \text{ mm}$
Total gripping torque (external gripping) [Ncm] at 6 bar		
	22 ... 880	22 ... 64
Maximum permissible characteristic load values at the gripper jaw		
	Fz [N] 124	20
	Mx [Nm] 5.7	0.4
	My [Nm] 2.2	0.4
	Mz [Nm] 3.6	0.4
Gripper finger length [mm]		
	Max. 120	Max. 40
Gripping angle per gripper jaw [°]		
	-3 ... +18 	-4 ... +18 
Repetition accuracy [mm]		
	≤ 0.04	≤ 0.02
Gripping force retention		
	-	-
Proximity sensors/sensors for position sensing at the gripper		
	■	-
Advantages		
	<ul style="list-style-type: none"> - Sturdy - Cost-effective - Integrated sensors 	<ul style="list-style-type: none"> - Compact - Single-acting
Technical data and dimensions		
Further information	→ Info 116	→ Info 116

Parallel grippers HGPT, robust

Key features



At a glance

The force generated by the linear motion is translated into the gripper jaw movement via a wedge mechanism with guided motion sequence. This also guarantees synchronous movement of the gripper jaw. The virtually backlash-free slideway is realised using ground-in gripper jaws.

Flexible range of applications

- Double-acting gripper
- Compression spring for supplementary or retaining gripping forces
- For use as a single-acting gripper with only one compressed air connection
- Suitable for external and internal gripping

Gripper closed

Gripper open

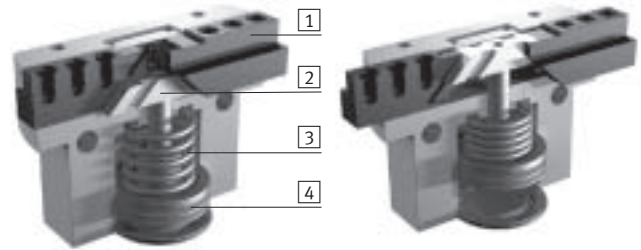

- 1 Gripper jaw
- 2 Wedge with restricted guidance
- 3 Spring
- 4 Piston with magnet



Gripper selection software
www.festo.com/en/engineering

Sealing air connection

Compressed air flows past the gripper jaw when sealing air (max. 0.5 bar) is connected.

This prevents, for example, particles and soluble cutting oil from entering the gripper jaw guides.

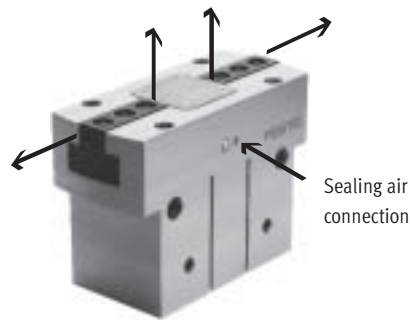

Versatile compressed air connections

Direct from the front

Via adapter plate from underneath

Mounting options

Direct mounting from above

from underneath and from the side

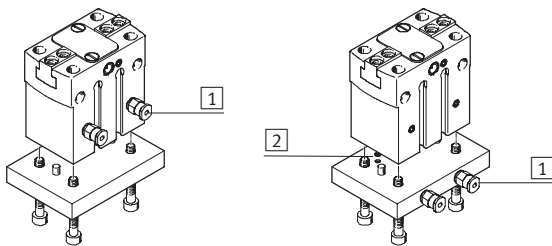

- 1 Compressed air connections
- 2 O-rings

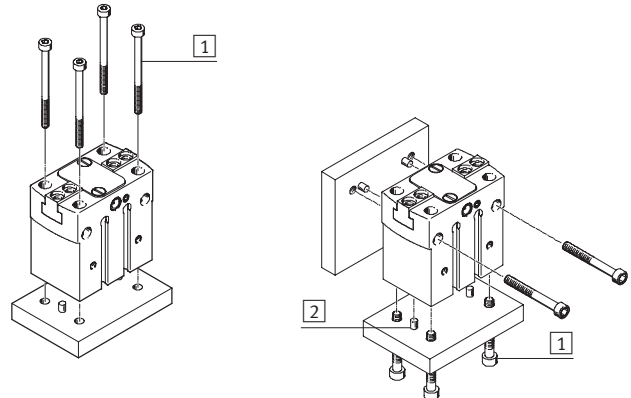

- 1 Mounting screws
- 2 Centring pins

- - Note

Grippers are not designed for the following application:

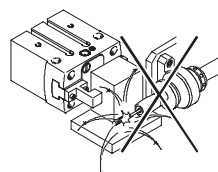

- Welding spatter

Parallel grippers HGPT, robust

Peripherals overview and type codes

Peripherals overview

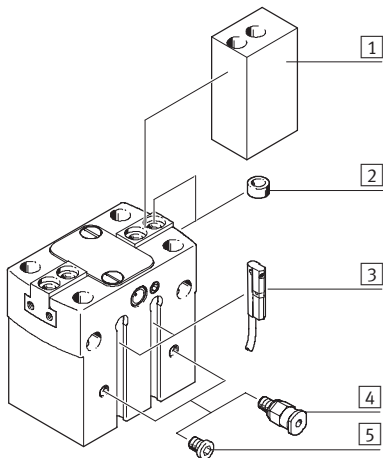

System product for handling and assembly technology

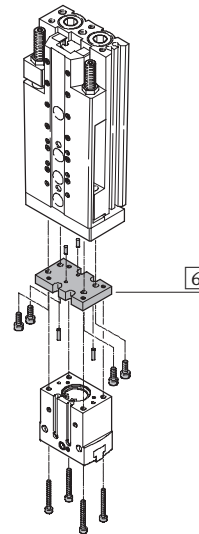

Accessories			
Type		Brief description	→ Page
1	Unmachined gripper finger BUB-HGPT	Unmachined part specially matched to the gripper jaws for custom building of gripper fingers	24
2	Centring sleeve ZBH	For centring when attaching gripper fingers	25
3	Proximity sensor SME/SMT-10	For sensing the piston position	25
4	Push-in fitting QS	For connecting compressed air tubing with standard external diameters	www.festo.com
5	Blanking plug B	For sealing compressed air connections when using air connections at the front	25
6	-	Drive/gripper connections	www.festo.com

Type codes

		HGPT	-	16	-	A	-	G1
Type								
HGPT	Parallel gripper							
Size								
Position sensing								
A	For proximity sensing							
Gripping force retention								
G1	Open							
G2	Closed							



Parallel grippers HGPT, robust

FESTO

Technical data

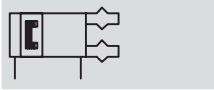
Function
Double-acting
HGPT-...-A



 Size
16 ... 63 mm
 Stroke
6 ... 32 mm



Single-acting or
with gripping force retention ...
... open HGPT-...-G1



... closed HGPT-...-G2



General technical data							
Size	16	20	25	35	40	50	63
Design	Wedge mechanism Guided motion sequence						
Mode of operation	Double-acting						
Gripper function	Parallel						
Number of gripper jaws	2						
Max. applied load per external gripper finger ¹⁾ [N]	0.5	1	1.5	2	2.5	3	4
Stroke per gripper jaw [mm]	3	4	6	8	10	12	16
Pneumatic connection	M3	M3	M5	M5	M5	G $\frac{1}{8}$	G $\frac{1}{8}$
Pneumatic connection Sealing air	M3	M3	M5	M5	M5	M5	M5
Repetition accuracy ²⁾ [mm]	< 0.03	< 0.04		< 0.05			
Max. interchangeability [mm]	0.2						
Max. gripper jaw backlash ³⁾ [mm]	0.02						
Max. gripper jaw angular backlash [°]	0.1						
Max. operating frequency [Hz]	3				2		
Rotational symmetry [mm]	< \varnothing 0.2						
Position sensing	For proximity sensing						
Type of mounting	Via through-hole and dowel pin Via female thread and dowel pin						
Fitting position	Any						

- 1) Valid for unthrottled operation
- 2) End-position drift under constant conditions of use with 100 consecutive strokes in the direction of movement of the gripper jaws
- 3) In the direction of the gripper jaw movement

Operating and environmental conditions			
Min. operating pressure	HGPT-...-A	[bar]	3
	HGPT-...-G...	[bar]	5
Max. operating pressure		[bar]	8
Operating medium	Filtered compressed air, lubricated or unlubricated		
Ambient temperature ¹⁾		[°C]	+5 ... +60
Corrosion resistance class CRC ²⁾	2		

- 1) Note operating range of proximity sensors
- 2) Corrosion resistance class 2 according to Festo standard 940 070
Components requiring moderate corrosion resistance. Externally visible parts with primarily decorative surface requirements which are in direct contact with a normal industrial environment or media such as coolants or lubricating agents

Parallel grippers HGPT, robust

Technical data

FESTO

Weight [g]							
Size	16	20	25	35	40	50	63
HGPT-...-A	102	183	361	625	1209	1984	3633
HGPT-...-G1	104	186	371	645	1252	2102	3763
HGPT-...-G2	104	186	371	645	1252	2102	3763

Materials

Sectional view

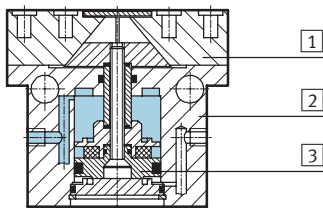

Parallel gripper		
1	Gripper jaw	Hardened steel
2	Housing	Aluminium, coated with CompCote
3	Piston	Gunmetal (red brass)
-	Seals	Nitrile rubber
Note on materials		Free of copper, PTFE and silicone

Gripping force [N] at 6 bar

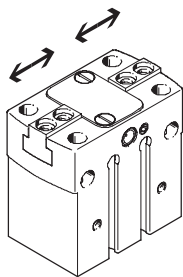

Size	16	20	25	35	40	50	63
Gripping force per gripper jaw							
Opening	42	75	110	250	300	480	825
Closing	36	70	100	230	270	440	770
Total gripping force							
Opening	84	150	220	500	600	960	1650
Closing	72	140	200	460	540	880	1540

Characteristic load values at the gripper jaws

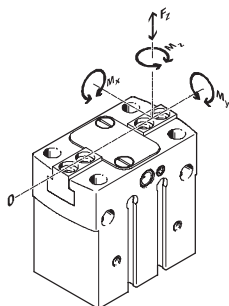

The indicated permissible forces and torques refer to a single gripper jaw. The indicated values include the lever arm, additional applied loads caused by the workpiece or external gripper

fingers, as well as forces which occur during movement. The zero coordinate line (gripper finger guide) must be taken into consideration for the calculation of torques.

Size	16	20	25	35	40	50	63	
Max. permissible force F_z	[N]	200	300	500	900	1500	2500	4000
Max. permissible torque M_x	[Nm]	10	15	30	50	80	100	140
Max. permissible torque M_y	[Nm]	7	10	25	40	60	90	120
Max. permissible torque M_z	[Nm]	5	8	15	30	40	60	80

Parallel grippers HGPT, robust

Technical data

FESTO

Mass moment of inertia [kgm²x10⁻⁴]

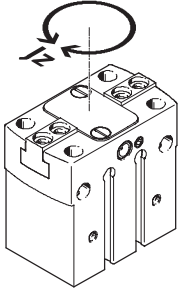

Mass moment of inertia [kgm²x10⁻⁴]
for parallel grippers in relation to the
central axis with no load.

Size	16	20	25	35	40	50	63
HGPT-...-A	0.177	0.391	1.263	3.383	9.673	25.147	74.991
HGPT-...-G1	0.178	0.392	1.272	3.411	9.786	25.460	75.409
HGPT-...-G2	0.178	0.392	1.272	3.411	9.786	25.460	75.409

Opening and closing times [ms] at 6 bar

without external gripper fingers

with external gripper fingers

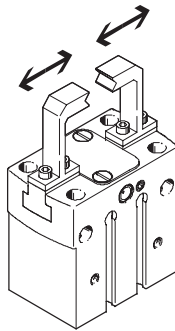
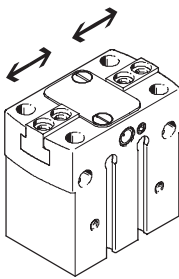

The indicated opening and closing
times [ms] have been measured at
room temperature and at 6 bar oper-
ating pressure with horizontally
mounted gripper without external

gripper fingers. The grippers must be
throttled for greater applied loads.
Opening and closing times must then
be adjusted correspondingly.

Size		16	20	25	35	40	50	63
without external gripper fingers								
HGPT-...-A	Opening	20	31	30	40	66	85	150
	Closing	21	31	33	40	61	76	135
HGPT-...-G1	Opening	10	26	30	39	57	65	123
	Closing	44	51	64	92	130	150	282
HGPT-...-G2	Opening	41	52	50	78	100	130	260
	Closing	21	31	30	39	61	70	130
with external gripper fingers as a function of applied load								
HGPT-...	1 N	100	-	-	-	-	-	-
	2 N	200	150	100	-	-	-	-
	3 N	300	250	200	150	100	-	-
	4 N	-	350	300	250	200	150	-
	5 N	-	-	400	350	300	250	200
	6 N	-	-	-	450	400	300	250
	8 N	-	-	-	-	-	450	400
	10 N	-	-	-	-	-	-	500

Parallel grippers HGPT, robust

Technical data

Max. permissible applied load [N] of the add-on gripper fingers, with unthrottled operation

Size	16	20	25	35	40	50	63
HGPT-...-	0.5	1	1.5	2	2.5	3	4

Gripping force F_{Grip} per gripper jaw as a function of operating pressure and lever arm x

Gripping forces related to operating pressure and lever arm can be determined for the various sizes using the following graphs.

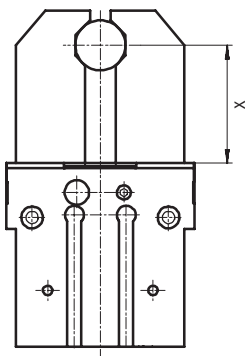

As external gripper: Closing operation

HGPT-16-A

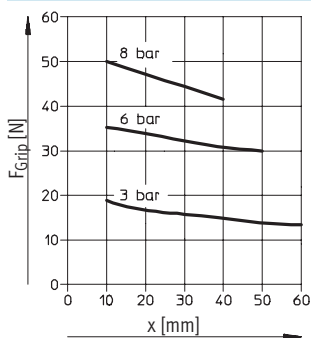

HGPT-20-A

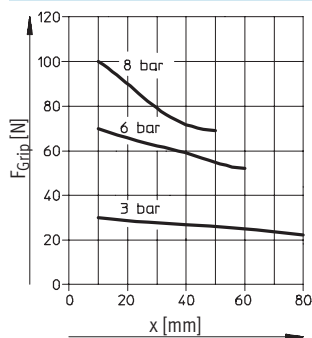

HGPT-25-A

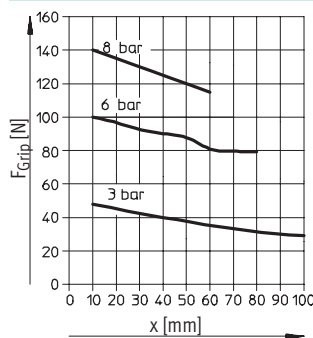

HGPT-35-A

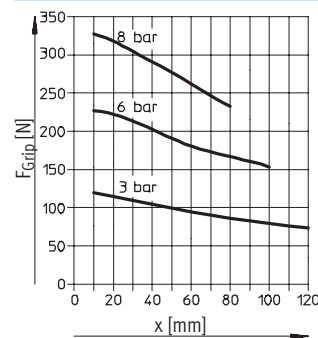

HGPT-40-A

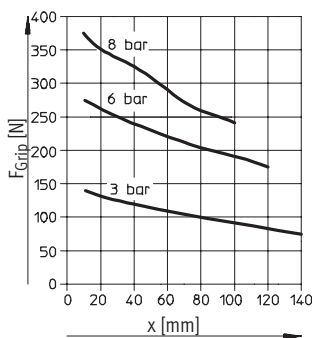

HGPT-50-A

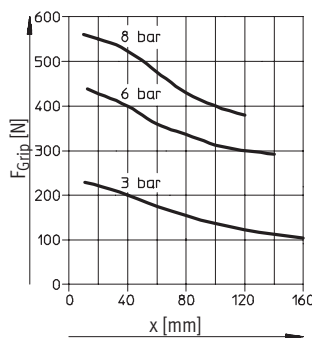

HGPT-63-A

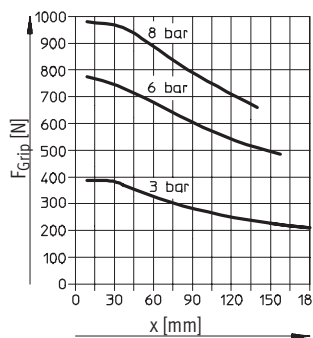

Parallel grippers HGPT, robust

Technical data

Gripping force F_{Grip} per gripper jaw as a function of operating pressure and lever arm x
As internal gripper: Opening operation

HGPT-16-A

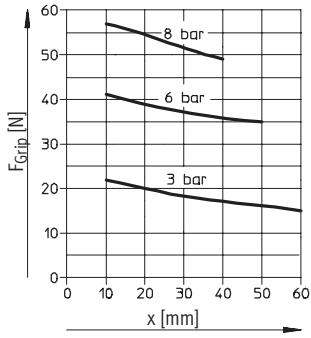

HGPT-20-A

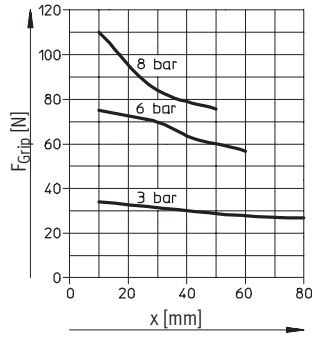

HGPT-25-A

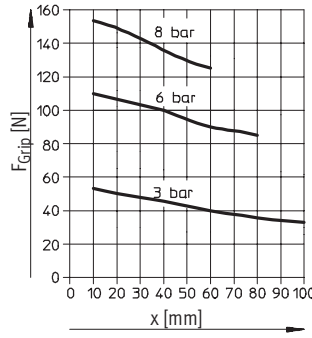

HGPT-35-A

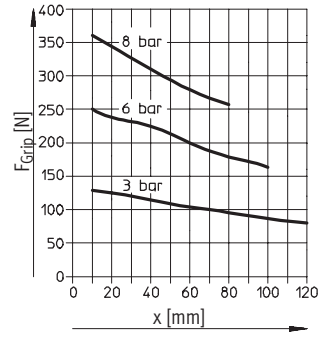

HGPT-40-A

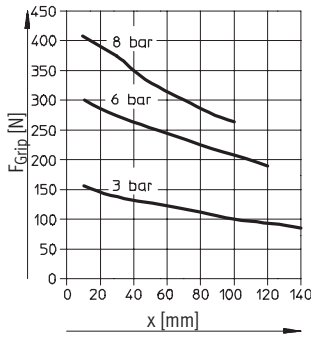

HGPT-50-A

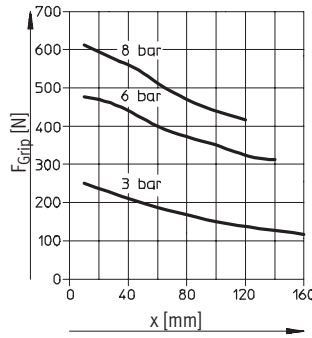

HGPT-63-A

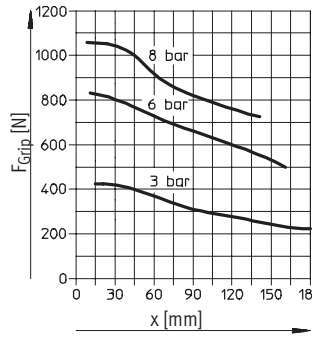

Parallel grippers HGPT, robust

Technical data

Spring force F_{Spring} as a function of gripper size and overall stroke l

Gripping force retention for HGPT-...-G...

Spring forces F_{Spring} as a function of gripper size and overall stroke l can be determined for the various gripper types (HGPT-...-G...) using the following graphs.

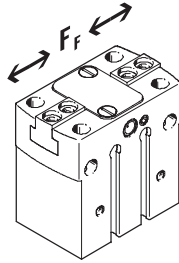

Size 16 ... 35

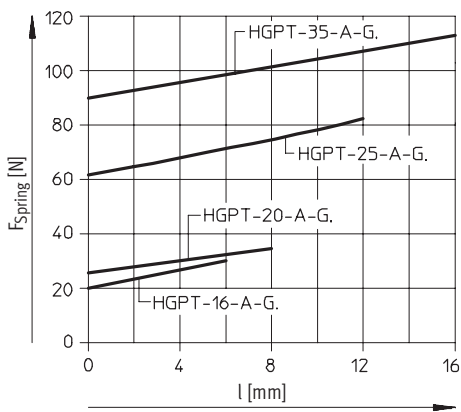

Size 40 ... 63

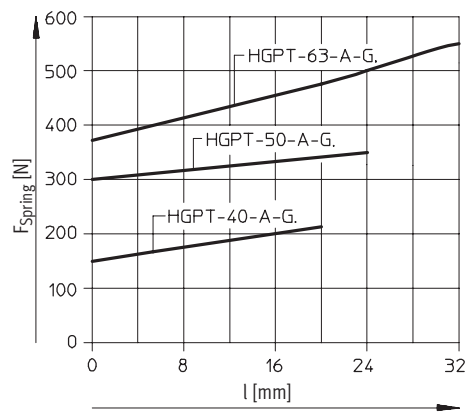

The lever arm x must be taken into consideration when determining the actual spring force F_{Stotal} . The formulae for calculating the spring force are provided in the table opposite.

Size	$F_{Stotal} =$
16	$-0.2 * x + 0.8 * F_{Spring}$
20	$-0.375 * x + 0.8 * F_{Spring}$
25	$-0.25 * x + 0.8 * F_{Spring}$
35	$-1 * x + 0.8 * F_{Spring}$
40	$-0.9 * x + 0.8 * F_{Spring}$
50	$-1.36 * x + 0.8 * F_{Spring}$
63	$-2.2 * x + 0.8 * F_{Spring}$

Determination of the actual gripping forces F_{Gr} for HGPT-...-G1 and HGPT-...-G2 depending on the application

Parallel grippers with integrated spring type HGPT-...-G1 (opening gripping force retention) and HGPT-...-G2 (closing gripping force retention) can be used as:

- single-acting grippers
- grippers with supplementary gripping force and
- grippers with gripping force retention depending on requirements.

In order to calculate available gripping forces F_{Gr} (per gripper jaw), the gripping force (F_{Grip}) and spring

force (F_{Stotal}) must be combined accordingly.

Application

Single-acting

- Gripping with spring force:
 $F_{Gr} = F_{Stotal}$
- Gripping with pressure force:
 $F_{Gr} = F_{Grip} - F_{Stotal}$

Supplementary gripping force

- Gripping with pressure and spring force:
 $F_{Gr} = F_{Grip} + F_{Stotal}$

Gripping force retention

- Gripping with spring force:
 $F_{Gr} = F_{Stotal}$

Parallel grippers HGPT, robust

Technical data

Gripping force F_H per gripper jaw at 6 bar as a function of lever arm x and eccentricity y

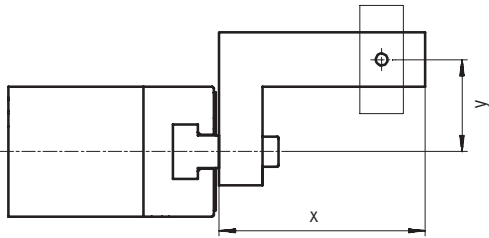

Gripping forces at 6 bar dependent upon eccentric application of force and the maximum permissible off-centre point of force application can be determined for the various sizes using the following graphs.

Calculation example

Given:

Lever arm $x = 40$ mm

Eccentricity $y = 45$ mm

To be found:

Gripping force at 6 bar

Procedure:

- Determine the intersection xy between lever arm x and eccentricity y in the graph for HGPT-25-A...
- Draw an arc (with centre at origin) through intersection xy
- Determine the intersection between the arc and the X axis
- Read the gripping force

Result:

Gripping force = approx. 83 N

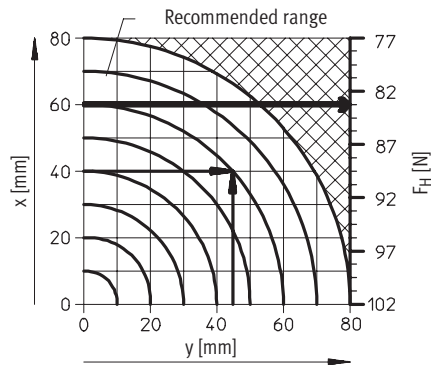

As external gripper: Closing operation

HGPT-16-A

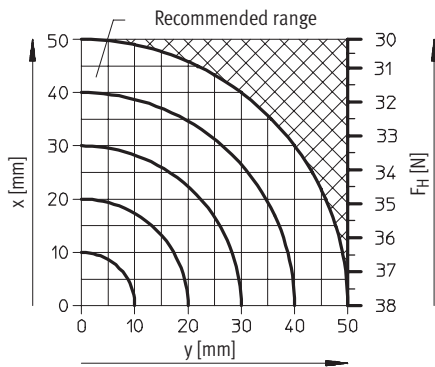

HGPT-20-A

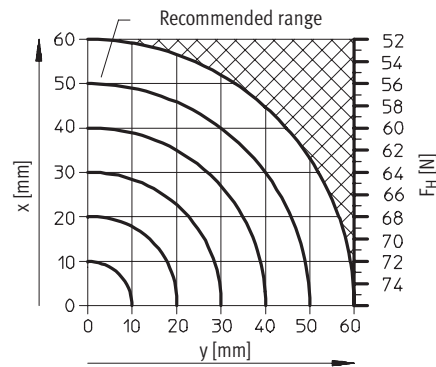

HGPT-25-A

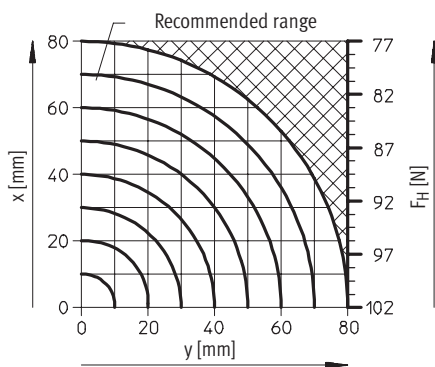

HGPT-35-A

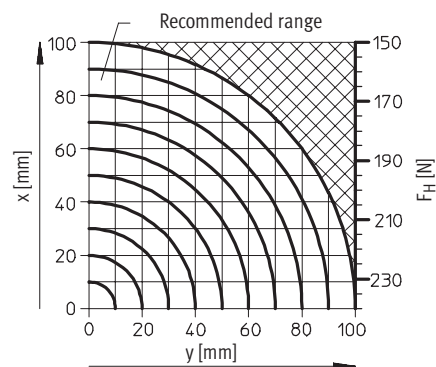

Parallel grippers HGPT, robust

Technical data

Gripping force F_H per gripper jaw at 6 bar as a function of lever arm x and eccentricity y

HGPT-40-A

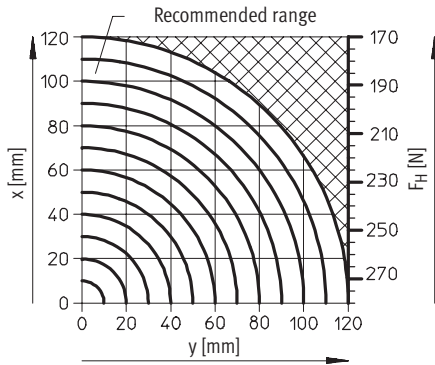

HGPT-50-A

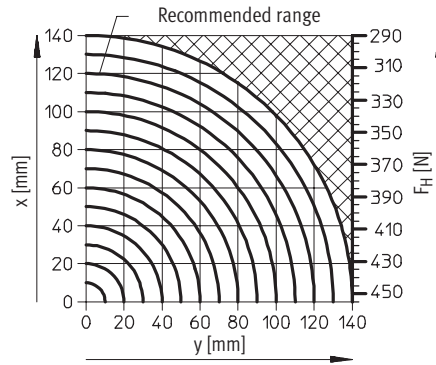

HGPT-63-A

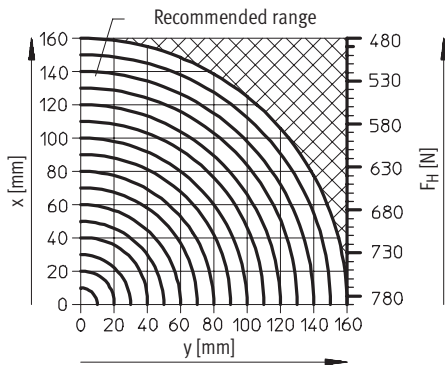

As internal gripper: Opening operation

HGPT-16-A

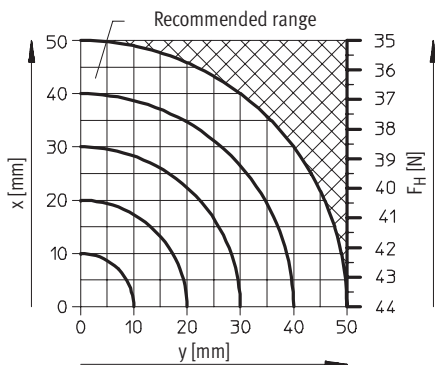

HGPT-20-A

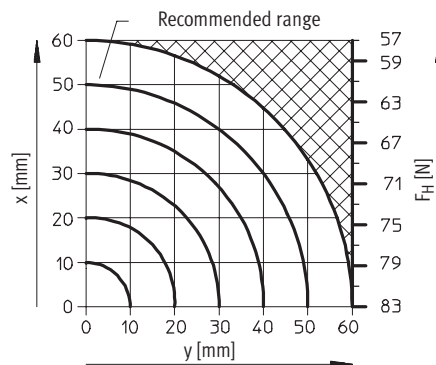

HGPT-25-A

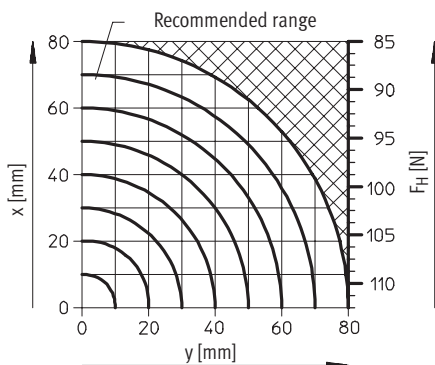

HGPT-35-A

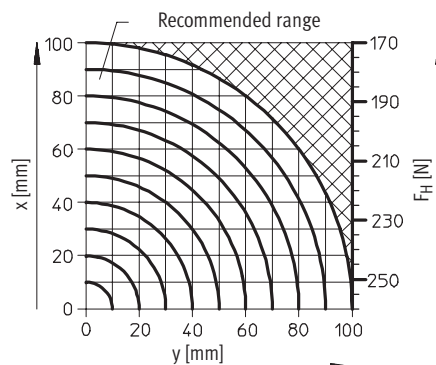

Parallel grippers HGPT, robust

Technical data

FESTO

Gripping force F_H per gripper jaw at 6 bar as a function of lever arm x and eccentricity y

HGPT-40-A

HGPT-50-A

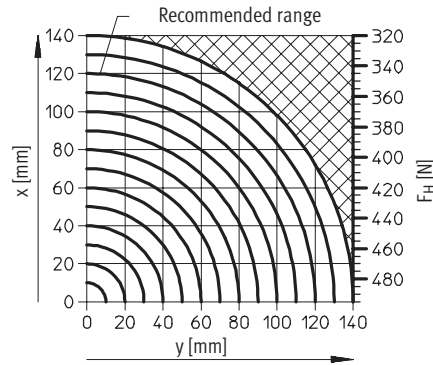
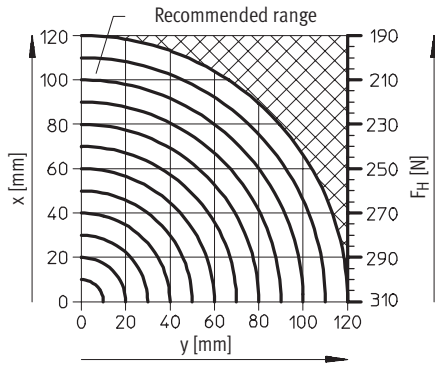

HGPT-63-A

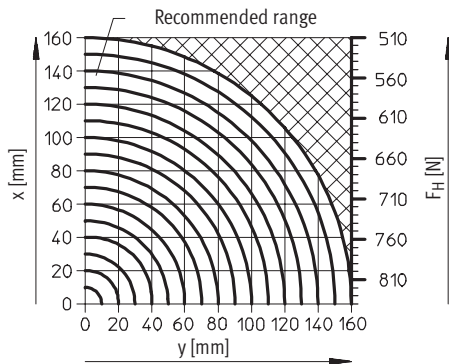

Dimensions

Download CAD data → www.festo.com/en/engineering

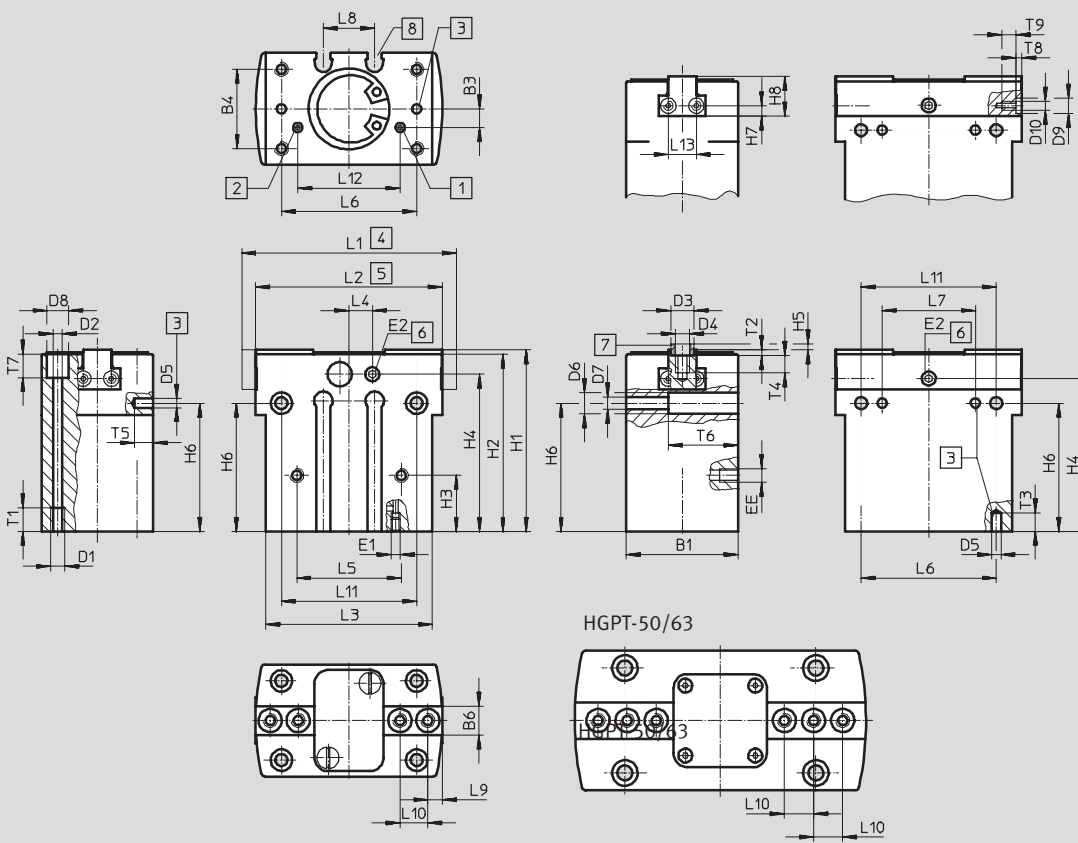

Parallel grippers HGPT, robust

Technical data

- 1) Compressed air connection opening, either on the side or bottom (bottom connection sealed on delivery)
- 2) Compressed air connection closing, either on the side or bottom (bottom connection sealed on delivery)
- 3) Hole for dowel pin (not included in scope of delivery)
- 4) Gripper jaw open
- 5) Gripper jaw closed
- 6) Sealing air connection (sealed on delivery)
- 7) Centring sleeves ZBH (4 included in scope of delivery)
- 8) Slot for proximity sensor

Size [mm]	B1 ±0.05	B3 ±0.1	B4 ±0.1	B6 -0.05 -0.1	D1	D2 ∅	D3 ∅ H8/h7	D4	D5 ∅ H7	D6 ∅	D7 ∅	D8 ∅
16	24	4	17	6	M3	2.6	5	M3	2	4.6+0.1	2.6	4.6+0.1
20	28	7	22	6.5	M4	3.2	5	M3	3	6+0.2	3.2	6+0.2
25	36	10	27	10	M5	4.2	7	M4	4	8+0.3	4.2	8+0.3
35	42	9	32	12	M5	4.2	9	M6	4	10+0.3	5.3	8+0.3
40	50	13	38	14	M6	5.1	9	M6	5	11+0.3	6.4	9+0.3
50	60	14	45	15.5	M8	6.4	9	M6	6	13.5+0.3	8.4	11+0.3
63	72	12	56	20	M8	6.4	12	M8	6	13.5+0.3	8.4	11+0.3

Size [mm]	D9 ∅ H8	D10	EE	E1	E2	H1 ±0.05	H2 ±0.05	H3 ±0.1	H4	H5 -0.3	H6 ±0.02 ¹⁾ ±0.1 ²⁾	H7 ±0.02 ¹⁾ ±0.1 ²⁾
16	-	M2	M3	M2	M3	39	38	12	33.7	1.2	27.5	2.25
20	5	M3	M3	M3	M3	46	45	15	37	1.2	24	3
25	5	M3	M5	M3	M5	57	56	20	46	1.4	34	4.5
35	7	M5	M5	M4	M5	67	66	28	53	1.9	38	5.5
40	7	M5	M5	M5	M5	83	82	36	68	1.9	53	5.5
50	7	M5	G ¹ / ₈	M5	M5	97	96	30	78	1.9	61	7.5
63	7	M5	G ¹ / ₈	M5	M5	117	116	26	92	2.4	67	9

Size [mm]	H8 -0.02	L1 ±0.5	L2 ±0.5	L3 ±0.1	L4	L5 ±0.1	L6 ±0.02 ¹⁾ ±0.1 ²⁾	L7 ±0.02	L8 +0.1	L9 ±0.02 ¹⁾ ±0.1 ²⁾	L10 ±0.02 ¹⁾ ±0.1 ²⁾	L11 ±0.1
16	8.5	46	40	35.8	3.8	22.4	29	20	11	3	6	29
20	12	58	50	44	0	28	35	24	18	4	8	35
25	16	76	64	52	0	28	42	20	17	5	12	42
35	19	96	80	64	0	40	52	40	24	6	15	52
40	22	120	100	80	0	48	66	50	32	10	18	66
50	25.5	149	125	100	0	56	82	60	32	10	12.5	82
63	32	192	160	125	0	74	100	76	34	10	18	100

Size [mm]	L12 ±0.1	L13 ±0.02 ¹⁾ ±0.1 ²⁾	T1 min.	T2 +0.1	T3 min.	T4 min.	T5 min.	T6	T7 +0.2	T8 +0.1	T9
16	22	6	5	1.3	4	5	4	15	24	-	3
20	24	6	6	1.3	4	5	4	19	11	1.3	6
25	28	6	10	1.6	4	5	4	24	16	1.3	6
35	40	13	10	2.1	6	10	4	27	19	1.6	9
40	44	13	12	2.1	6	10	6	33	20	1.6	9
50	56	13	12	2.1	8	10	8	43	23	1.6	9
63	70	13	12	2.6	10	12	10	55	35	1.6	9

1) For centring
2) For through-and threaded hole

Parallel grippers HGPT, robust

Technical data and accessories

FESTO

Ordering data						
Size [mm]	Double-acting without compression spring		Single-acting or with gripping force retention			
	Part No.	Type	open		closed	
	Part No.	Type	Part No.	Type	Part No.	Type
16	535 858	HGPT-16-A	535 859	HGPT-16-A-G1	535 860	HGPT-16-A-G2
20	535 861	HGPT-20-A	535 862	HGPT-20-A-G1	535 863	HGPT-20-A-G2
25	535 864	HGPT-25-A	535 865	HGPT-25-A-G1	535 866	HGPT-25-A-G2
35	535 867	HGPT-35-A	535 868	HGPT-35-A-G1	535 869	HGPT-35-A-G2
40	535 870	HGPT-40-A	535 871	HGPT-40-A-G1	535 872	HGPT-40-A-G2
50	535 873	HGPT-50-A	535 874	HGPT-50-A-G1	535 875	HGPT-50-A-G2
63	535 876	HGPT-63-A	535 877	HGPT-63-A-G1	535 878	HGPT-63-A-G2

Accessories

Unmachined gripper finger

BUB-HGPT

(Scope of delivery: 2 pcs.)

Material:
Aluminium

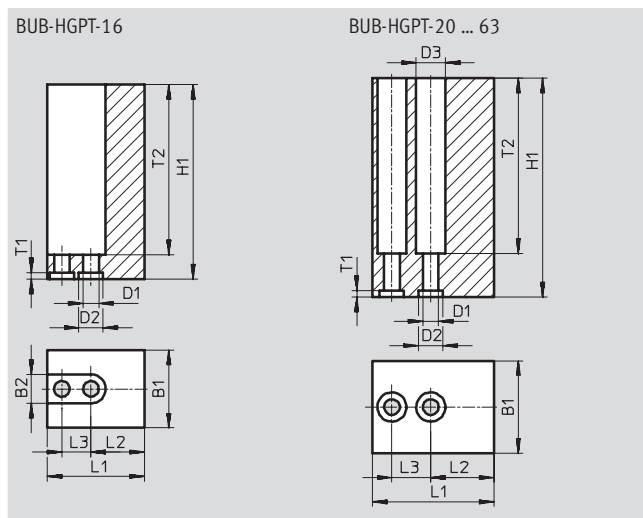

Dimensions and ordering data							
For size	B1	B2	D1	D2	D3	H1	L1
[mm]	±0.05	+0.22	∅ H13	∅ H8	∅ +0.22	±0.05	±0.05
16	16	6	3.2	5	-	40	20
20	19	-	3.2	5	6	45	25
25	24	-	4.3	7	8	60	32
35	28	-	6.4	9	11	70	40
40	34	-	6.4	9	11	75	50
50	40	-	6.4	9	11	100	62.5
63	50	-	8.4	12	13.5	120	80



For size	L2	L3	T1	T2	Weight per unmachined gripper finger [g]	Part No.	Type
[mm]	±0.02 ¹⁾ ±0.1 ²⁾	±0.01 ¹⁾ ±0.1 ¹⁾	+0.1				
16	11	6	1.3	35	28	537 198	BUB-HGPT-16
20	13	8	1.3	36	53	537 199	BUB-HGPT-20
25	15	12	1.6	51	112	537 200	BUB-HGPT-25
35	19	15	2.1	61	182	537 201	BUB-HGPT-35
40	22	18	2.1	71	312	537 202	BUB-HGPT-40
50	27.5	25	2.1	91	638	537 203	BUB-HGPT-50
63	34	36	2.6	110	1 230	537 204	BUB-HGPT-63

1) For centring
2) For through-hole





Parallel grippers HGPT, robust



Accessories



FESTO

Ordering data						
	For size [mm]	Remarks	Weight [g]	Part No.	Type	PU ¹⁾
Centring sleeve ZBH Technical data → www.festo.com						
	16, 20	For centring unmachined gripper jaws/gripper fingers on the gripper jaws	1	189 652	ZBH-5	10
	25		1	186 717	ZBH-7	10
	35, 40, 50		1	150 927	ZBH-9	10
	63		1	189 653	ZBH-12	10
	20, 25	For lateral centring of gripper fingers on the gripper jaws	1	189 652	ZBH-5	10
	35, 40, 50, 63		1	186 717	ZBH-7	10
Blanking plug B Technical data → www.festo.com						
	16, 20	For sealing the compressed air connections	0.6	30 979	B-M3-S9	10
	25, 35, 40		1	174 308	B-M5-B	10
	50, 63		5	3 568	B-1/8	10

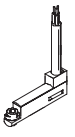
1) Packaging unit quantity

Ordering data – Proximity sensors for C-slot, in-line connecting cable						Technical data → www.festo.com	
	Assembly	Electrical connection		Cable length [m]	Part No.	Type	
		Cable	Plug M8				
NO contact, magneto-resistive							
	Insertable from above	3-core	–	2.5	525 915	SMT-10F-PS-24V-K2,5L-OE	
		–	3-pin	0.3	525 916	SMT-10F-PS-24V-K0,3L-M8D	
	Insertable from end	–	3-pin	0.3	173 220	SMT-10-PS-SL-LED-24	
		3-core	–	2.5	173 218	SMT-10-PS-KL-LED-24	
NO contact, magnetic reed							
	Insertable from above	–	3-pin	0.3	525 914	SME-10F-DS-24V-K0,3L-M8D	
		3-core	–	2.5	525 913	SME-10F-DS-24V-K2,5L-OE	
	Insertable from end	–	3-pin	0.3	173 212	SME-10-SL-LED-24	
		3-core	–	2.5	173 210	SME-10-KL-LED-24	

Ordering data – Proximity sensors for C-slot, connecting cable at right angles						Technical data → www.festo.com	
	Assembly	Electrical connection		Cable length [m]	Part No.	Type	
		Cable	Plug M8				
NO contact, magneto-resistive							
	Insertable from above	3-core	–	2.5	526 674	SMT-10F-PS-24V-K2,5Q-OE	
		–	3-pin	0.3	526 675	SMT-10F-PS-24V-K0,3Q-M8D	
NO contact, magnetic reed							
	Insertable from above	3-core	–	2.5	526 670	SME-10F-DS-24V-K2,5Q-OE	
		–	3-pin	0.3	526 671	SME-10F-DS-24V-K0,3Q-M8D	

Ordering data – Plug sockets with cable						Technical data → www.festo.com	
	Assembly	Switch output		Connection	Cable length [m]	Part No.	Type
		PNP	NPN				
Straight socket							
	Union nut M8	■	■	3-pin	2.5	159 420	SIM-M8-3GD-2,5-PU
					5	159 421	SIM-M8-3GD-5-PU
Angled socket							
	Union nut M8	■	■	3-pin	2.5	159 422	SIM-M8-3WD-2,5-PU
					5	159 423	SIM-M8-3WD-5-PU

Parallel grippers HGPL, robust, with long stroke

Key features



At a glance

- Space-saving and suitable for high forces
 - Two parallel and opposing pistons move the gripper jaws directly and without loss of force
- Reliable
 - A pinion that synchronises the movement of both gripper jaws ensures controlled, precise and centred gripping
 - The space-saving design of the parallel gripper jaws permits a long guide length for the gripper jaws
- Sturdy
 - The T-slot in combination with a long guide length allows the gripper jaws to withstand high forces and torques
- Flexible range of applications
 - Double-acting gripper suitable for external and internal gripping.
 - Versatile mounting options and compressed air connections
 - Opening stroke can be adjusted to optimise time

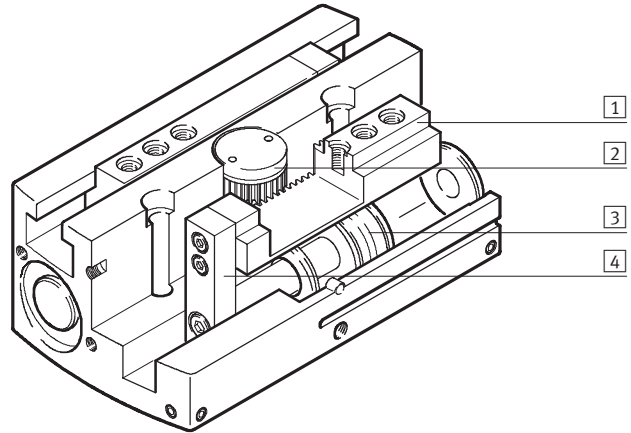

- 1 Gripper jaw
- 2 Synchronising gear
- 3 Piston with magnet
- 4 Driver



Gripper selection software
www.festo.com/en/engineering

Versatile compressed air connections

Direct from the front

Via adapter plate from underneath

Mounting options

Direct mounting from above

from underneath

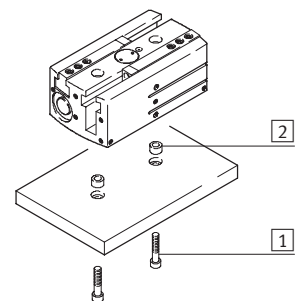
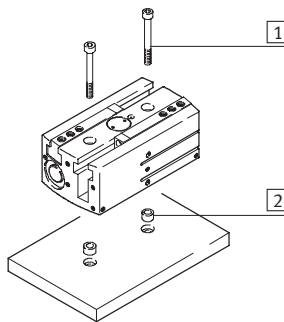
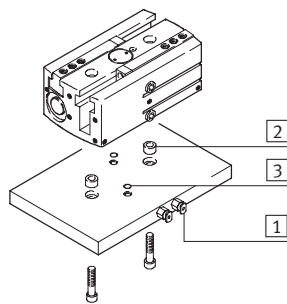
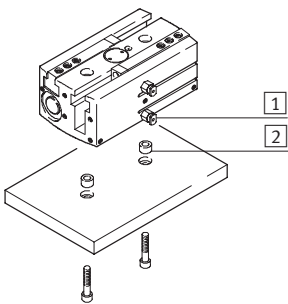

- 1 Compressed air connections
- 2 Centring sleeves
- 3 O-rings

- 1 Mounting screws
- 2 Centring sleeves

Note
 Grippers are not designed for the following or similar applications:

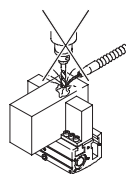

- Aggressive media
- Machining

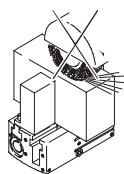

- Grinding dust

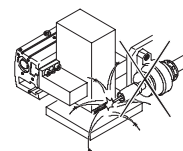

- Welding spatter

Parallel grippers HGPL, robust, with long stroke

Peripherals overview and type codes

Peripherals overview

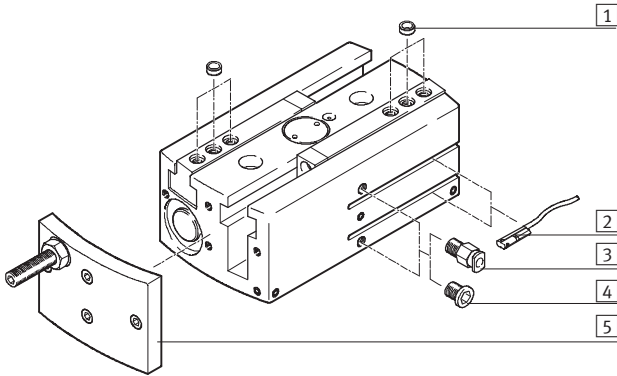

System product for handling and assembly technology

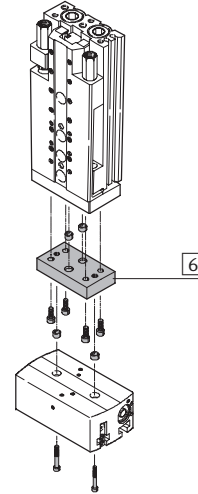

Accessories			
Type		Brief description	→ Page
1	Centring sleeve ZBH	For centring when attaching gripper fingers	40
2	Proximity sensor SME/SMT-10	For sensing the piston position	41
3	Push-in fitting QS	For connecting compressed air tubing with standard external diameters	www.festo.com
4	Blanking plug B	For sealing compressed air connections when using air connections at the front	40
5	Stroke reducing plate HGPL-HR-...	For reducing the opening stroke	39
6	-	Drive/gripper connections	www.festo.com
-	Unmachined gripper finger BUB-HGPL	Unmachined part specially matched to the gripper jaws for custom building of gripper fingers	40

Type codes

HGPL		-	14	-	40	-	A
Type							
HGPL	Parallel gripper						
Size							
Stroke [mm]							
Position sensing							
A	For proximity sensing						

Parallel grippers HGPL, robust, with long stroke

FESTO

Technical data

Function
Double-acting
HGPL...-A

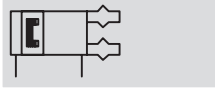

www.festo.com/en/
Spare_parts_service
Wearing parts kits
→ 38



⊘ - Size
14 ... 40 mm

┆ - Stroke
80 ... 160 mm

General technical data							
Size	14		25		40		
Design	Synchronised pneumatic pistons Guided motion sequence						
Mode of operation	Double-acting						
Gripper function	Parallel						
Number of gripper jaws	2						
Max. applied load per external gripper finger ¹⁾ [N]	0.8		2.5		4.2		
Stroke per gripper jaw [mm]	40	80	40	80	40	80	
Pneumatic connection	M5						
Repetition accuracy ²⁾ [mm]	< 0.03						
Max. interchangeability [mm]	< 0.2						
Max. gripper jaw backlash ³⁾ [mm]	< 0.05						
Max. operating frequency [Hz]	< 1						
Rotational symmetry [mm]	< ∅ 0.2						
Position sensing	For proximity sensing						
Type of mounting	Via through-holes and centring sleeves With female thread and centring sleeves						
Fitting position	Any						

- 1) Valid for unthrottled operation
2) End-position drift under constant conditions of use with 100 consecutive strokes in the direction of movement of the gripper jaws
3) In the direction of the gripper jaw movement

Operating and environmental conditions	
Operating pressure [bar]	3 ... 8
Operating medium	Filtered compressed air, lubricated or unlubricated
Ambient temperature ¹⁾ [°C]	+5 ... +60
Corrosion resistance class CRC ²⁾	2

- 1) Note operating range of proximity sensors
2) Corrosion resistance class 2 according to Festo standard 940 070
Components requiring moderate corrosion resistance. Externally visible parts with primarily decorative surface requirements which are in direct contact with a normal industrial environment or media such as coolants or lubricating agents

Weight [g]						
Size	14		25		40	
Stroke per gripper jaw	40 mm	440	1400	3300		
	80 mm	720	2200	4800		

Parallel grippers HGPL, robust, with long stroke

Technical data

Materials

Sectional view

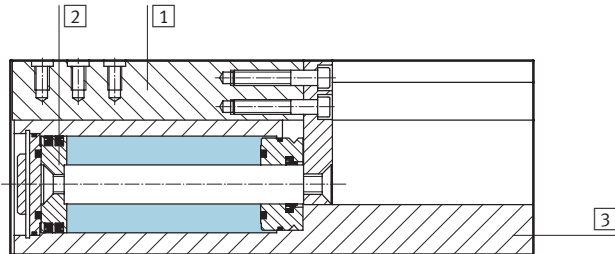

Parallel gripper		
1	Gripper jaw	Hardened steel, Citrocoated
2	Piston	High-alloy steel
3	Housing	Wrought aluminium alloy with CompCote
-	Seals	Nitrile rubber, polyurethane
Note on materials		Free of copper, PTFE and silicone

Gripping force [N] at 6 bar

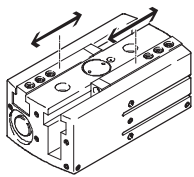

Size	Stroke	14	25	40
Gripping force per gripper jaw				
Opening	40 mm	60	180	440
	80 mm	64	205	520
Closing	40 mm	80	240	550
	80 mm	80	255	605
Total gripping force				
Opening	40 mm	120	360	880
	80 mm	128	410	1040
Closing	40 mm	160	480	1100
	80 mm	160	510	1210

Characteristic load values at the gripper jaws

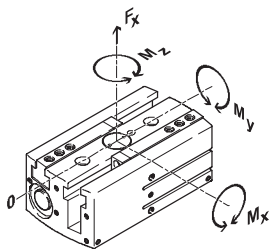

The indicated permissible forces and torques refer to a single gripper jaw. The indicated values include the lever arm, additional applied loads caused

by the workpiece or external gripper fingers, as well as forces which occur during movement. The zero coordinate line (gripper finger guide slot) must be

taken into consideration for the calculation of torques.

Size		14	25	40
Max. permissible force F_z	[N]	500	1500	2500
Max. permissible torque M_x	[Nm]	35	100	125
Max. permissible torque M_y	[Nm]	35	60	80
Max. permissible torque M_z	[Nm]	35	70	100

Parallel grippers HGPL, robust, with long stroke

Technical data

Mass moment of inertia [kgm²x10⁻⁴]

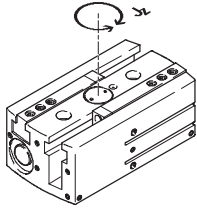

Mass moment of inertia [kgm²x10⁻⁴] for parallel grippers in relation to the central axis with no load.

Size		14	25	40
Stroke per gripper jaw	40 mm	4.69	18.88	66.83
	80 mm	21.93	78.7	198.87

Opening and closing times [ms] at 6 bar

without external gripper fingers

with external gripper fingers

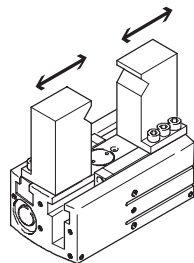
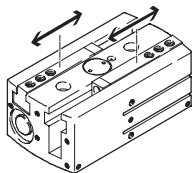

The indicated opening and closing times [ms] have been measured at room temperature and at 6 bar operating pressure with horizontally mounted additional gripper fingers.

The grippers must be throttled for greater applied loads. Opening and closing times must then be adjusted correspondingly.

Size		14	25	40
without external gripper fingers – opening				
Stroke per gripper finger	40 mm	104	194	238
	80 mm	234	360	414
without external gripper fingers – closing				
Stroke per gripper finger	40 mm	86	192	205
	80 mm	217	366	438
with external gripper fingers as a function of applied load				
Stroke per gripper finger	40 mm			
Applied load	1 N	108	–	–
	2 N	136	–	–
	3 N	167	210	–
	4 N	192	243	–
	5 N	–	272	260
	6 N	–	–	284
	8 N	–	–	328
	with external gripper fingers as a function of applied load (80 mm stroke)			
Stroke per gripper finger	80 mm			
Applied load	1 N	243	–	–
	2 N	343	–	–
	3 N	420	401	–
	4 N	485	463	–
	5 N	–	518	478
	6 N	–	–	524
	8 N	–	–	604

Parallel grippers HGPL, robust, with long stroke

Technical data

Gripping force F_{Grip} per gripper jaw as a function of operating pressure and lever arm x

Gripping forces related to operating pressure and lever arm can be determined for the various sizes using the following graphs.

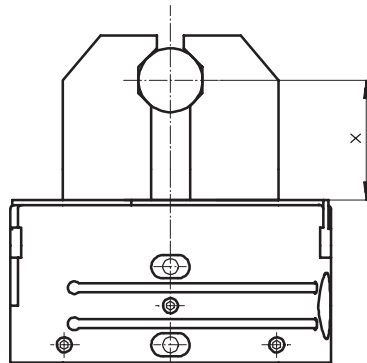

As external gripper: Closing operation

HGPL-14-40-A

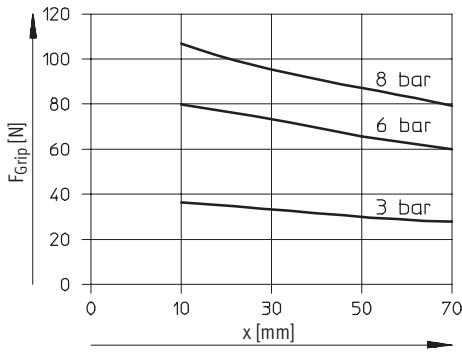

HGPL-14-80-A

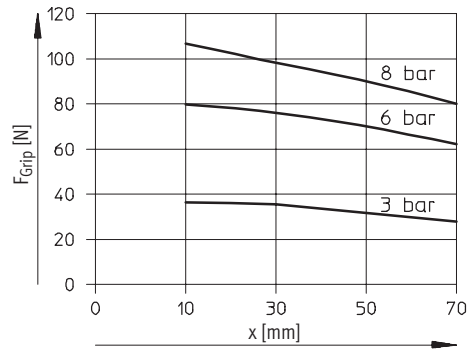

HGPL-25-40-A

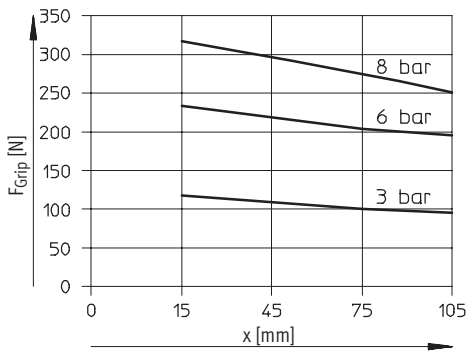

HGPL-25-80-A

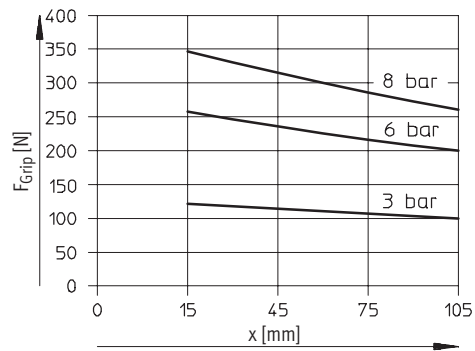

HGPL-40-40-A

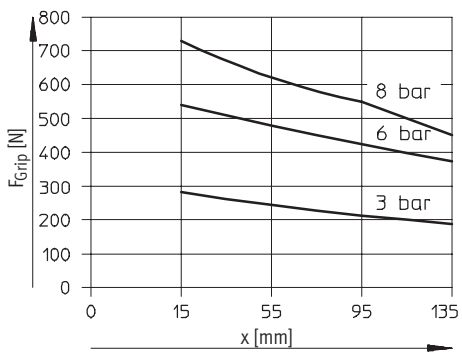

HGPL-40-80-A

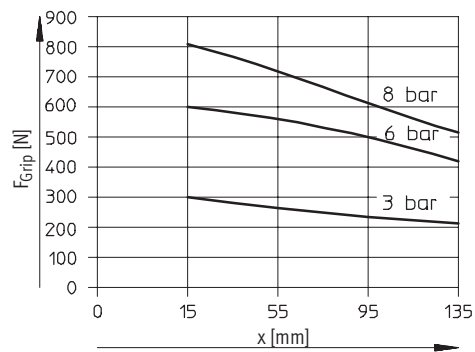

Parallel grippers HGPL, robust, with long stroke

Technical data

FESTO

Gripping force F_{Grip} per gripper jaw as a function of operating pressure and lever arm x
As internal gripper: Opening operation

HGPL-14-40-A

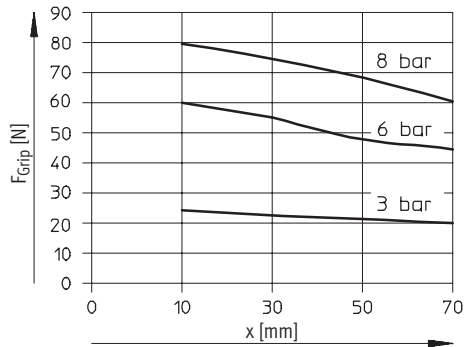

HGPL-14-80-A

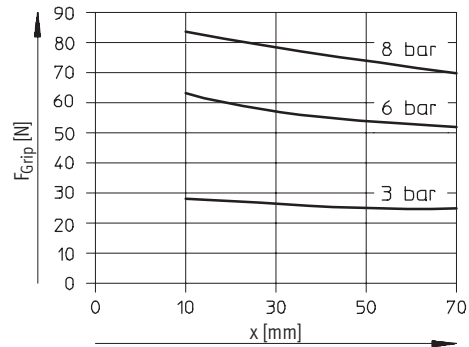

HGPL-25-40-A

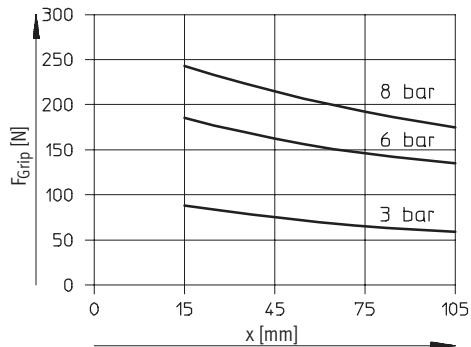

HGPL-25-80-A

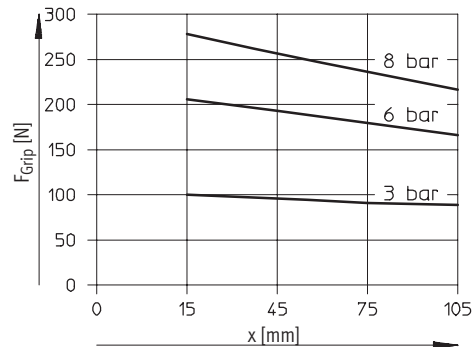

HGPL-40-40-A

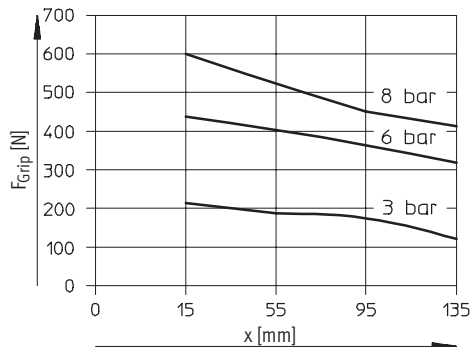

HGPL-40-80-A

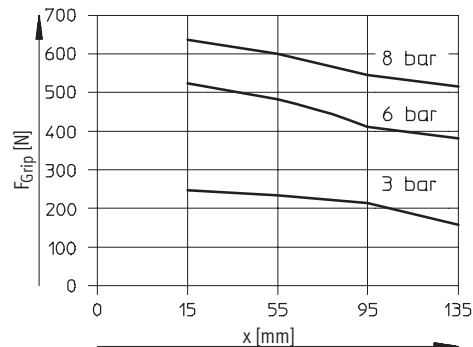

Parallel grippers HGPL, robust, with long stroke

Technical data

Gripping force F_{Grip} per gripper jaw as a function of lever arm x and eccentricity y

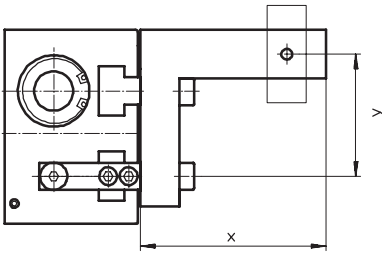

Gripping forces at 6 bar dependent upon eccentric application of force and the maximum permissible off-centre point of force application can be determined for the various sizes using the following graphs.

Calculation example

Given:

Lever arm $x = 32$ mm

Eccentricity $y = 22$ mm

To be found:

Gripping force at 6 bar

Procedure:

- Determine the intersection xy between lever arm x and eccentricity y in the graph for HGPL-14-40-A
- Draw an arc (with centre at origin) through intersection xy
- Determine the intersection between the arc and the X axis
- Read the gripping force

Result:

Gripping force = approx. 68.3 N

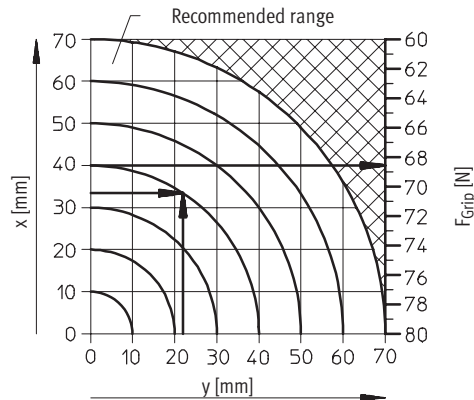

As external gripper: Closing operation

HGPL-14-40-A

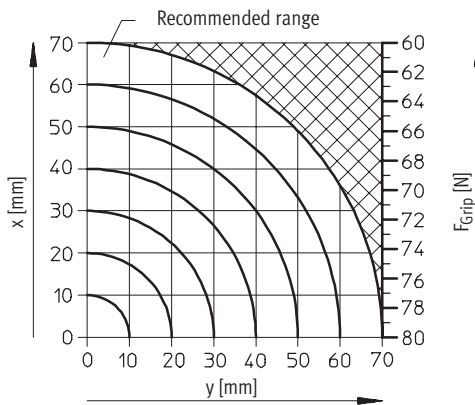

HGPL-14-80-A

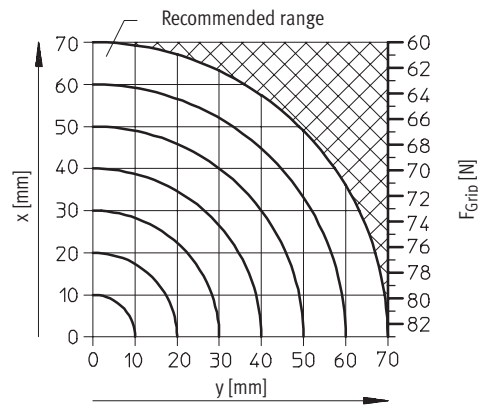

HGPL-25-40-A

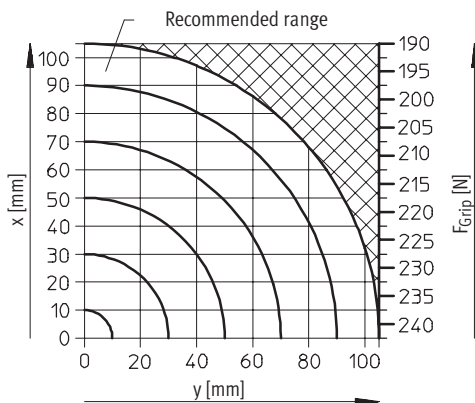

HGPL-25-80-A

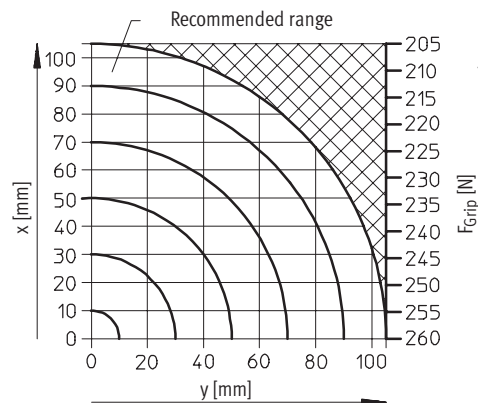

Parallel grippers HGPL, robust, with long stroke

Technical data

Gripping force F_{Grip} per gripper jaw as a function of lever arm x and eccentricity y

HGPL-40-40-A

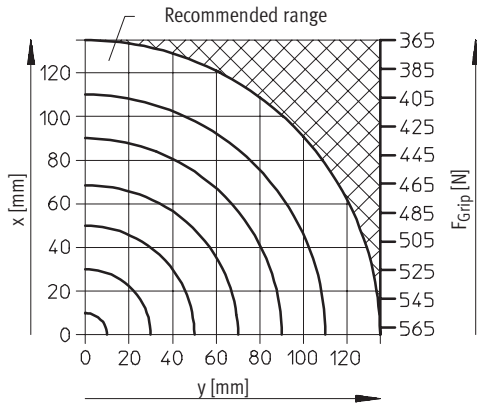

HGPL-40-80-A

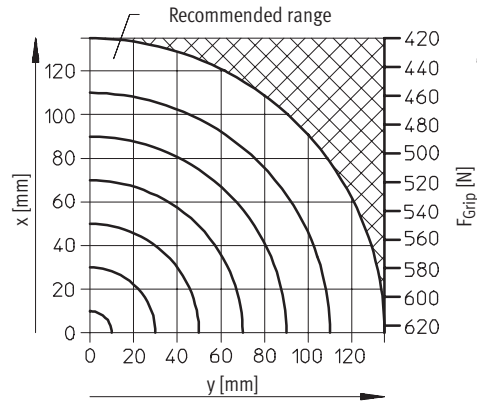

As internal gripper: Closing operation

HGPL-14-40-A

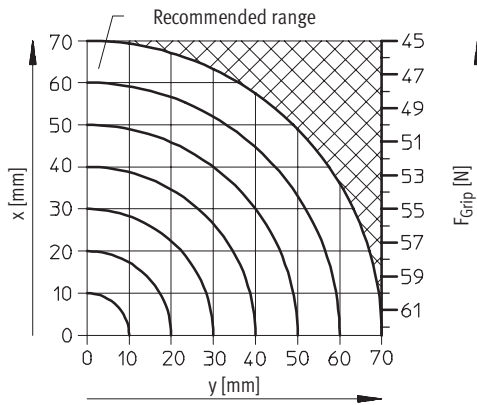

HGPL-14-80-A

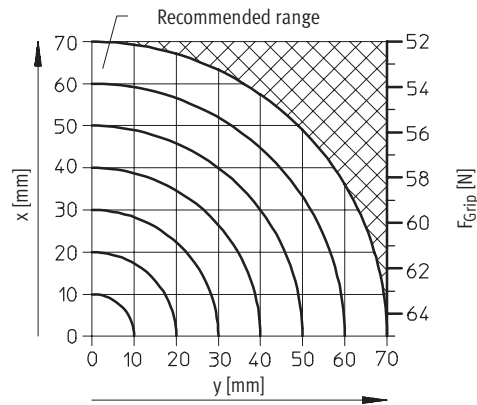

HGPL-25-40-A

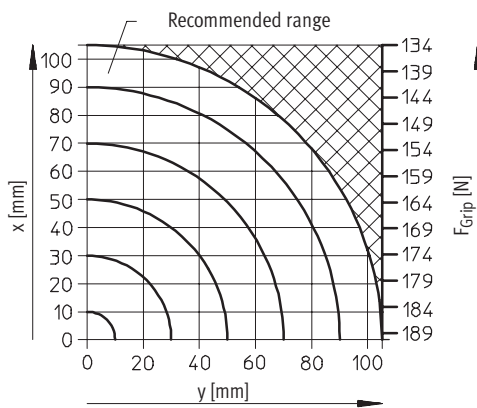

HGPL-25-80-A

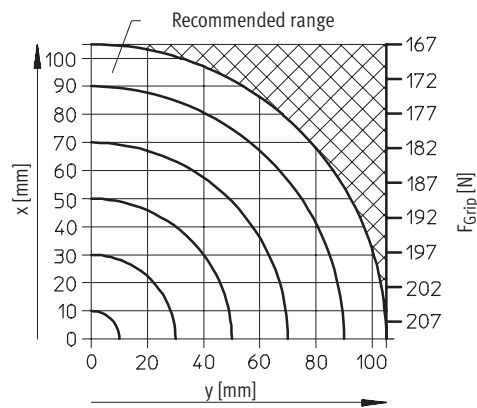

Parallel grippers HGPL, robust, with long stroke

Technical data

Gripping force F_{Grip} per gripper jaw as a function of lever arm x and eccentricity y

HGPL-40-40-A

HGPL-40-80-A

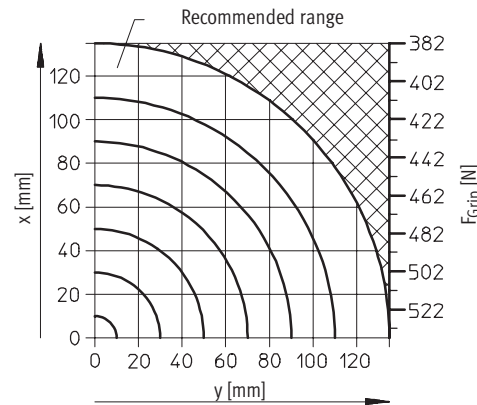
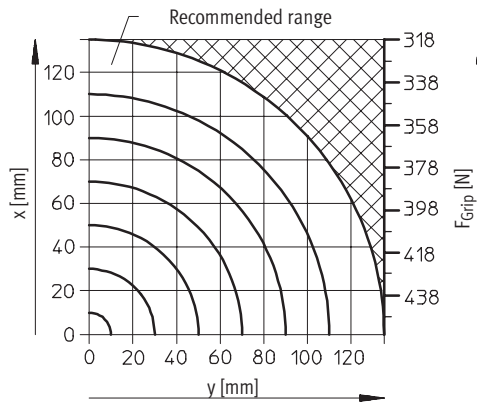

Parallel grippers HGPL, robust, with long stroke

Technical data

FESTO

Dimensions

Download CAD data → www.festo.com/en/engineering

Size 40

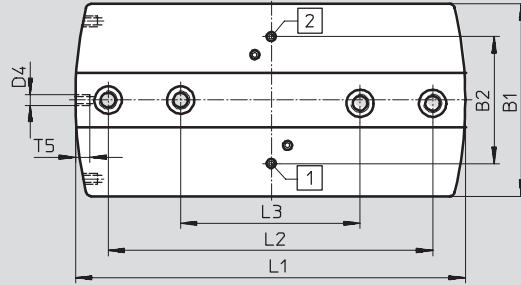

Size 14/25

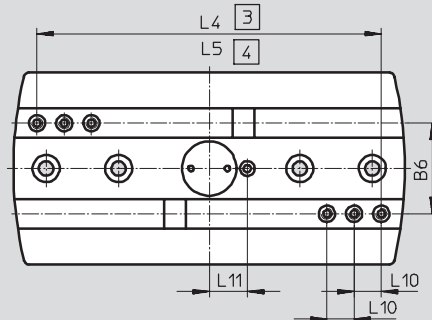
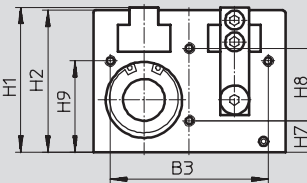
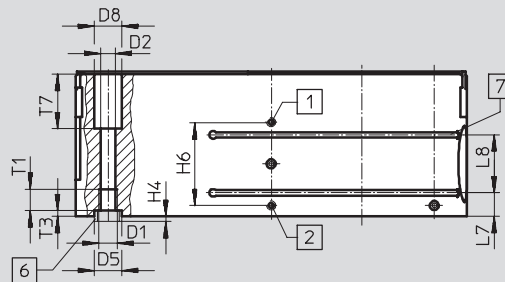
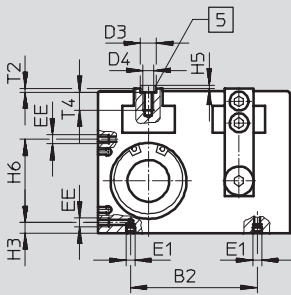
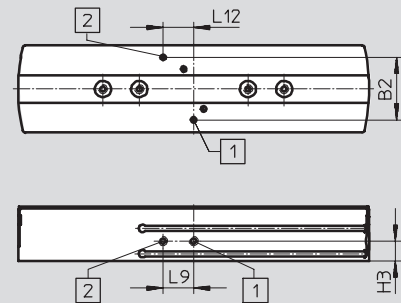

1 Compressed air connection opening, either on the side or bottom (bottom connection sealed on delivery)

2 Compressed air connection closing, either on the side or bottom (bottom connection sealed on delivery)

3 Gripper jaw open
4 Gripper jaw closed
5 Centring sleeves ZBH (4 included in scope of delivery)

6 Centring sleeves ZBH (2 included in scope of delivery)
7 Slot for proximity sensor SME/SMT-10

Parallel grippers HGPL, robust, with long stroke

Technical data

Type	B1 ±0.05	B2 ±0.1	B3 ±0.1	B6 ±0.01	D1	D2 ∅ +0.1	D3 ∅ H8/h7	D4	D5 ∅ H8/h7	D8 ∅ H13	EE	E1
HGPL-14-40	48	34.5	37	22	M5	4.2	5	M3	9	7.4	M5	M3
HGPL-14-80												
HGPL-25-40	80	60	65	38	M6	5.1	7	M5	9	10	M5	M5
HGPL-25-80												
HGPL-40-40	106	70	87	50	M10	8.5	9	M6	15	15	M5	M5
HGPL-40-80												

Type	H1	H2 ±0.1	H3 ±0.1	H4 -0.3	H5 -0.3	H6 ±0.1	H7 ±0.1	H8 ±0.1	H9 ±0.1	L1 ±0.1	L2 ±0.02 ¹⁾ ±0.1 ²⁾	L3 ±0.02 ¹⁾ ±0.1 ²⁾	L4 ±0.5
HGPL-14-40	30	29	11	1.9	1.2	-	10	12	18	113.6	-	60	102
HGPL-14-80										193.6	100	60	182
HGPL-25-40	50	49	18	1.9	1.4	-	18	20	30	126	-	60	104
HGPL-25-80										206	100	60	184
HGPL-40-40	80	78.5	6	2.9	1.9	46	17.5	40	50.5	136	-	100	110
HGPL-40-80										216	180	100	190

Type	L5 ±0.5	L7 ±0.1	L8 ±0.1	L9 ±0.2	L10 ±0.02 ¹⁾ ±0.1 ²⁾	L11 ±0.5	L12 ±0.1	T1 min.	T2 +0.1	T3 +0.1	T4 min.	T5 min.	T7 +0.1
HGPL-14-40	22	4	14	16.8	8	9	16.8	12	1.3	2.1	5	6	10
HGPL-14-80	22												
HGPL-25-40	24	11	14	20	10	17.5	20	12	1.6	2.1	8	7	17
HGPL-25-80	24												
HGPL-40-40	30	13	32	-	15	21	-	15	2.1	3.1	10	8	30
HGPL-40-80	30												

1) For centring
2) For through-hole

Parallel grippers HGPL, robust, with long stroke

Technical data

Ordering data			
Size [mm]	Stroke [mm]	Double-acting without compression spring	
		Part No.	Type
14			
	40	535 852	HGPL-14-40-A
	80	535 853	HGPL-14-80-A
25			
	40	535 854	HGPL-25-40-A
	80	535 855	HGPL-25-80-A
40			
	40	535 856	HGPL-40-40-A
	80	535 857	HGPL-40-80-A

Ordering data – Wearing parts kits			
Size [mm]	Part No. Type		
14	701 585	HGPL-14	
25	701 586	HGPL-25	
40	701 587	HGPL-40	

Parallel grippers HGPL, robust, with long stroke

Accessories

Stroke reducing plate HGPL-HR

Material:
Aluminium
Free of copper, PTFE and silicone

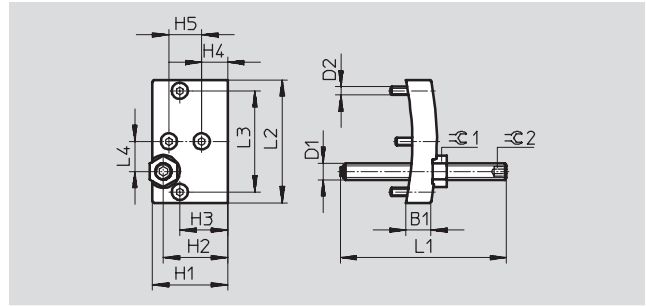

Dimensions and ordering data								
For size	B1	D1	D2	H1	H2	H3	H4	H5
[mm]	±0.1			±0.1	±0.1	±0.1	±0.1	±0.1
14	9	M6	M3	27.5	23.5	17.5	9.5	12
25	12	M8	M5	47.5	37.5	29.5	17.5	20
40	18	M12	M6	77	63	50	17	40

For size	L1	L2	L3	L4	≈C1	≈C2	Weight	Part No.	Type
[mm]	±1	±0.1	±0.1	±0.1			[g]		
14	61	45	37	11	10	3	45	539 092	HGPL-HR-14
25	61	77	65	19	13	4	150	539 093	HGPL-HR-25
40	61	103	87	25	19	6	455	539 094	HGPL-HR-40

Parallel grippers HGPL, robust, with long stroke



Accessories

Unmachined gripper finger

BUB-HGPL

(Scope of delivery: 2 pcs.)

Material:

Aluminium

Free of copper, PTFE and silicone

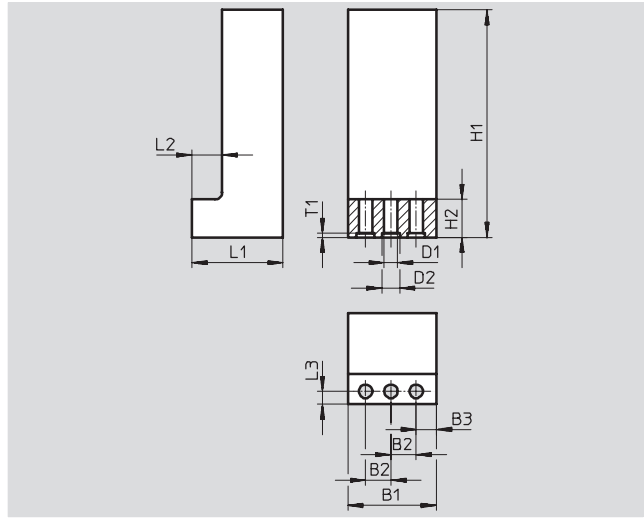

Dimensions and ordering data							
For size	B1	B2	B3	D1	D2	H1	H2
[mm]	±0.1	+0.02		+0.1	H8	±0.1	
14	25	8	4	3.2	5	80	11
25	35	10	8	5.3	7	120	15
40	50	15	10	6.4	9	150	18



For size	L1	L2	L3	T1	Weight per unmachined gripper finger [g]	Part No.	Type
[mm]	±0.1	+0.1	+0.1	+0.1			
14	20.5	8	3.3	1.3	75	537 316	BUB-HGPL-14
25	36	12	5	1.6	295	537 317	BUB-HGPL-25
40	49.5	16.5	8	2.1	720	537 318	BUB-HGPL-40



Ordering data						
	For size [mm]	Weight [g]	Part No.	Type	PU ¹⁾	
Centring sleeve for the gripper jaws ZBH Technical data → www.festo.com						
	14	1	189 652	ZBH-5	10	
	25	1	186 717	ZBH-7	10	
	40	1	150 927	ZBH-9	10	
Centring sleeve for the gripper ZBH Technical data → www.festo.com						
	14	1	189 652	ZBH-9	10	
	25					
	40	3	191 409	ZBH-15	10	
Blanking plug B Technical data → www.festo.com						
	14 (at front)	0.6	30 979	B-M3-S9	10	
	14, 25, 40	1	174 308	B-M5-B	10	



1) Packaging unit quantity

Parallel grippers HGPL, robust, with long stroke

Accessories

Ordering data – Proximity sensors for C-slot, magneto-resistive							Technical data → www.festo.com	
	Assembly	Switch output	Electrical connection		Cable length [m]	Connection direction	Part No.	Type
			Cable	Plug M8				
NO contact								
	Insertable from above	PNP	3-core	–	2.5	In-line	525 915	SMT-10F-PS-24V-K2,5L-OE
			–	3-pin	0.3	In-line	525 916	SMT-10F-PS-24V-K0,3L-M8D
						Lateral	526 675	SMT-10F-PS-24V-K0,3Q-M8D
	Insertable from end	PNP	–	3-pin	0.3	In-line	173 220	SMT-10-PS-SL-LED-24
			3-core	–	2.5		173 218	SMT-10-PS-KL-LED-24

Ordering data – Proximity sensors for C-slot, magnetic reed							Technical data → www.festo.com	
	Assembly	Electrical connection		Cable length [m]	Connection direction	Part No.	Type	
		Cable	Plug M8					
NO contact								
	Insertable from above	–	3-pin	0.3	In-line	525 914	SME-10F-DS-24V-K0,3L-M8D	
		3-core	–	2.5	In-line	525 913	SME-10F-DS-24V-K2,5L-OE	
		2-core				526 672	SME-10F-ZS-24V-K2,5L-OE	
	Insertable from end	–	3-pin	0.3	In-line	173 212	SME-10-SL-LED-24	
		3-core	–	2.5		173 210	SME-10-KL-LED-24	

Ordering data – Plug sockets with cable						Technical data → www.festo.com	
	Assembly	Switch output		Connection	Cable length [m]	Part No.	Type
		PNP	NPN				
Straight socket							
	Union nut M8	■	■	3-pin	2.5	159 420	SIM-M8-3GD-2,5-PU
					5	159 421	SIM-M8-3GD-5-PU
Angled socket							
	Union nut M8	■	■	3-pin	2.5	159 422	SIM-M8-3WD-2,5-PU
					5	159 423	SIM-M8-3WD-5-PU

Three-point grippers HGDT, robust

Features

At a glance

The force generated by the linear motion is translated into the gripper jaw movement via a force-guided triple wedge mechanism. This also guarantees synchronous movement of the gripper jaw. The virtually backlash-free slideway is realised using ground-in gripper jaws.

A wide range of uses:

- Double-acting gripper
- Compression springs for supplementing or retaining gripper forces, or for use as a single-acting gripper with only one compressed air connection
- Suitable for external and internal gripping

Sealing air connection:

Compressed air flows past the gripper jaw when sealing air (max. 0.5 bar) is connected.

This prevents particles and soluble oil, etc. from entering the gripper jaw guides.

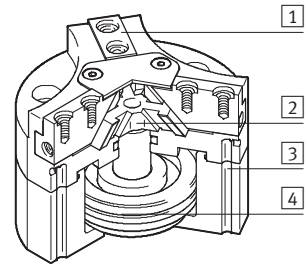

- 1 Three-point gripper jaw
- 2 Triple wedge mechanism
- 3 Slot for proximity sensor
- 4 Piston with magnet



Gripper selection software
www.festo.com/en/engineering

Wide range of air connections

Direct from the front

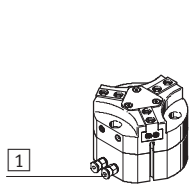

- 1 Compressed air connections
- 2 O-rings

Via adapter plate from underneath

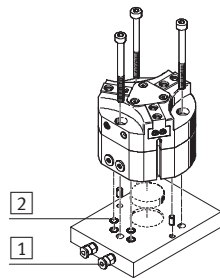

Mounting options

Direct mounting from above

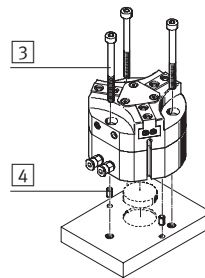

- 3 Mounting screws
- 4 Centring pins or centring disc

Via adapter plate from underneath

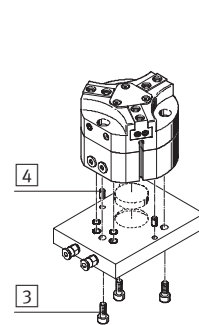

 Note

Grippers are not designed for use in the following applications:

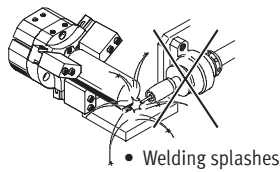

Three-point grippers HGDT, robust

Peripherals overview and type codes

Peripherals overview

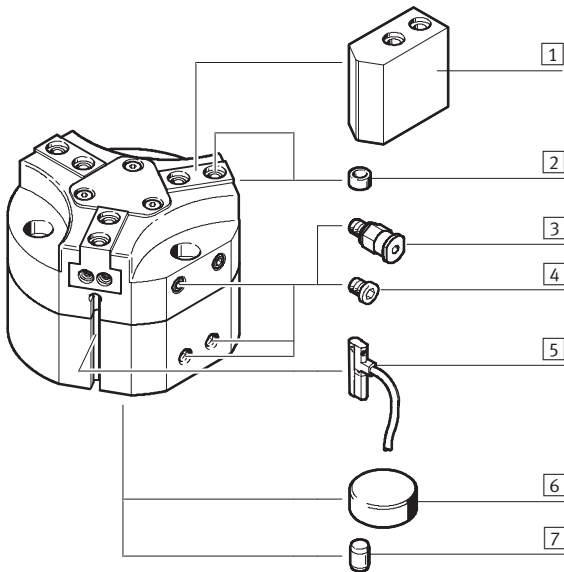

System product for handling and assembly technology

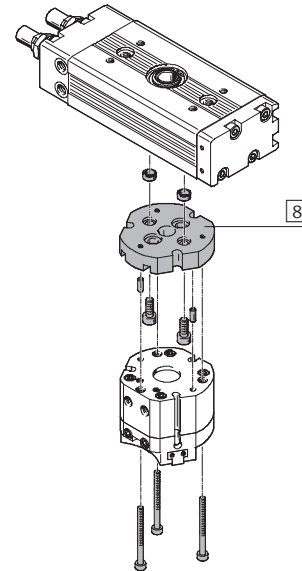

Accessories			
Type		Brief description	→ Page
1	Unmachined gripper finger BUB-HGDT	Unmachined part specially matched to the gripper jaws for custom building of gripper fingers	52
2	Centring sleeve ZBH	For centring unmachined gripper jaws/gripper fingers on the gripper jaws	53
3	Push-in fitting QS	For connecting compressed air tubing with standard external diameters	www.festo.com
4	Blanking plugs B	For sealing compressed air connections when using air connections at the front	53
5	With position sensing magnet SMT-10	For sensing the piston position, 3 slots available	53
6	Central mounting SLZZ	For centring the gripper when mounting	53
7	Locating pin	For centring the gripper when mounting	–
8	–	Drive/gripper connections	www.festo.com

Type code

HGDT		–	25	–	A	–	G1
Type							
HGDT	Three-point gripper						
Size							
Position sensing							
A	For proximity sensing						
Gripping force retention							
G1	Open						
G2	Closed						

Three-point grippers HGDT, robust

Technical data

Function
Double-acting
HGDT-...-A

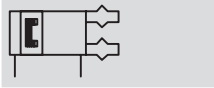



Single-acting or
with gripping force retention ...
... open HGDT-...-G1



... closed HGDT-...-G2



-  Size
25 ... 63
-  Stroke
3 ... 10 mm



General technical data					
Size	25	35	40	50	63
Constructional design	Wedge-shaped actuator Force-guided motion sequence				
Mode of operation	Double-acting				
Gripper function	3-point				
Number of gripper jaws	3				
Max. applied load per external gripper finger ¹⁾ [N]	0.1	0.3	0.7	1.6	2.5
Stroke per gripper jaw [mm]	3	4	6	8	10
Pneumatic connection	M5	M5	M5	G1/8	G1/8
Pneumatic connection Sealing air	M5				
Repetition accuracy ²⁾ [mm]	≤ 0.03				
Max. operating frequency [Hz]	≤ 4				
Position sensing	For proximity sensing				
Type of mounting	Via through-hole, locating pin or centring disc Via female thread, locating pin or centring disc				
Mounting position	Any				

1) Valid for unthrottled operation
2) Concentric to the central shaft

Operating and environmental conditions			
Min. operating pressure	HGDT-...-A [bar]		3
	HGDT-...-G... [bar]		4
Max. operating pressure	[bar]		8
Sealing air operating pressure	[bar]		0 ... 0.5
Operating medium	Filtered compressed air, lubricated or unlubricated		
Ambient temperature ¹⁾	[°C]		+5 ... +60
Corrosion resistance class CRC ²⁾			2

1) Note operating range of proximity sensors
2) Corrosion resistance class 2 to Festo standard 940 070
Components subject to moderate corrosion stress. Externally visible parts with primarily decorative surface requirements which are in direct contact with a normal industrial environment or media such as coolants or lubricating agents

Three-point grippers HGDT, robust

Technical data

FESTO

Weights [g]					
Size	25	35	40	50	63
HGDT-...-A	185	307	712	1,104	1,873
HGDT-...-G1	203	337	840	1,592	2,469
HGDT-...-G2	203	385	837	1,440	2,543

Materials

Sectional view

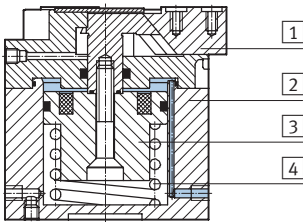

Three-point gripper	
1	Gripper jaw Hardened steel
2	Housing Aluminium, coated with CompCote
3	Piston Anodised aluminium
4	Spring Spring steel
-	Seals Nitrile rubber
Material note Copper, PTFE and silicone-free	

Gripping force [N] at 6 bar

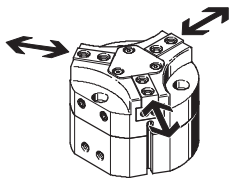

Size	25	35	40	50	63
Gripping force per gripper jaw					
opening	82	164	229	347	576
closing	69	152	206	307	551
Total gripping force					
opening	246	492	687	1,041	1,728
closing	207	456	618	921	1,653
Total gripping force with spring support (gripping force retention)					
opening	286	555	814	1,159	2,186
closing	228	547	712	1,052	2,172

Characteristic load values at the gripper jaws

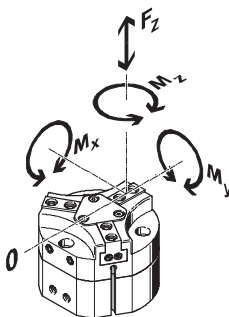

The indicated permissible forces and torques apply to a single gripper jaw. They include the lever arm, additional applied loads due to the workpiece or external gripper fingers, and acceleration forces occurring

during movement. The zero coordinate line (gripper finger point of rotation) must be taken into consideration for the calculation of torques.

Size	25	35	40	50	63	
Max. permissible force F_z	[N]	350	400	800	1,500	2,500
Max. permissible torque M_x	[Nm]	7	15	30	50	80
Max. permissible torque M_y	[Nm]	10	10	20	30	50
Max. permissible torque M_z	[Nm]	5	10	25	40	60

Three-point grippers HGDT, robust

Technical data

Moment of inertia [kgcm²]

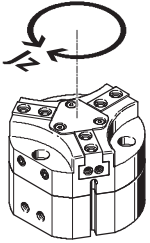

Requirements:

- The reference point is the central axis
- Without external gripper fingers
- In the load-free state

Size	25	35	40	50	63
HGDT-...-A	0.48	1.17	4.37	11.05	28.77
HGDT-...-G1	0.5	1.37	5.59	15.33	42.44
HGDT-...-G2	0.5	1.37	5.23	13.92	39.50

Opening and closing times [ms] at 6 bar

Without external gripper fingers

With external gripper fingers

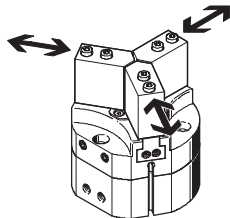
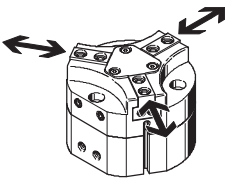

The indicated opening and closing times [ms] have been measured at room temperature at an operating pressure of 6 bar with horizontally mounted gripper without additional

gripper fingers. The grippers must be throttled for greater applied loads. Opening and closing times must then be adjusted accordingly.

Size		25	35	40	50	63
Without external gripper fingers						
HGDT-...-A	opening	28	40	62	85	152
	closing	25	45	59	75	142
HGDT-...-G1	opening	27	32	58	32	48
	closing	33	56	160	146	246
HGDT-...-G2	opening	33	46	111	61	159
	closing	25	35	87	70	107
With external gripper fingers per gripper finger (as a function of applied load)						
HGDT-...	0.2 N	80	-	-	-	-
	0.3 N	100	130	-	-	-
	0.7 N	150	200	115	-	-
	1 N	180	240	140	-	-
	1.5 N	220	290	170	-	-
	2 N	-	335	200	190	-
	2.5 N	-	-	220	210	190
	3 N	-	-	-	230	200
	4 N	-	-	-	270	230
	5 N	-	-	-	-	260

Three-point grippers HGDT, robust

Technical data

Gripping force F_{Grip} per gripper jaw as a function of operating pressure and lever arm x

The gripping forces, as a function of operating pressure and lever arm, can be determined from the following charts.

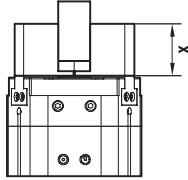

External gripping (closing)

HGDT-25-A

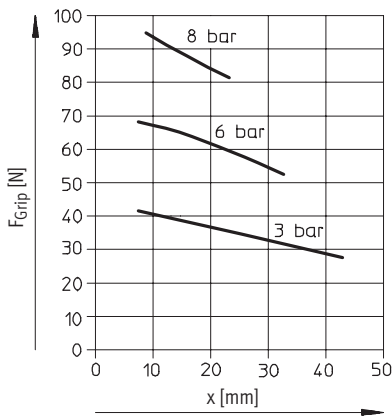

HGDT-35-A

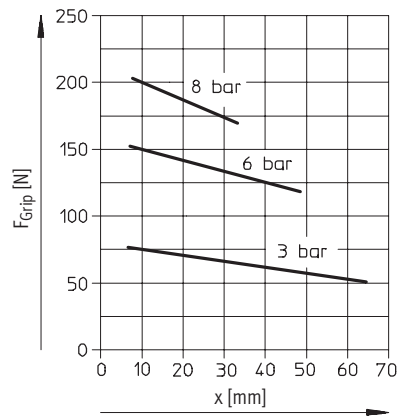

HGDT-40-A

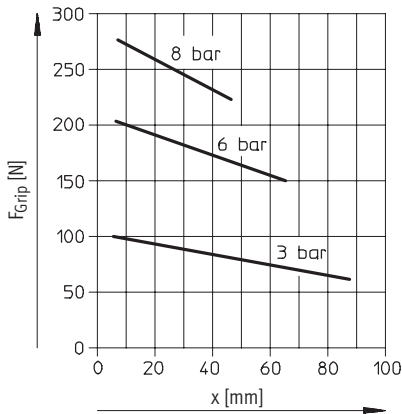

HGDT-50-A

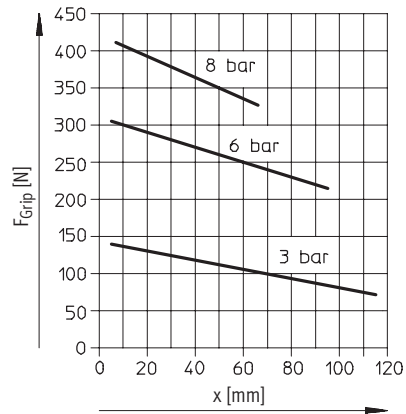

HGDT-63-A

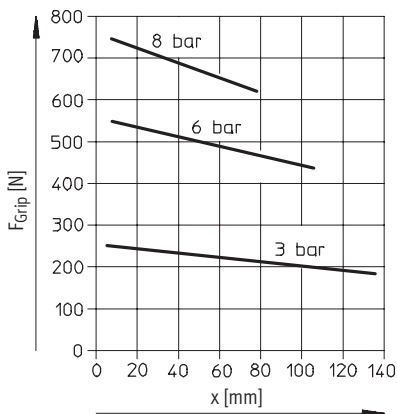

Three-point grippers HGDT, robust

Technical data

Gripping force F_{Grip} per gripper jaw as a function of operating pressure and lever arm x
Internal gripping (opening)

HGDT-25-A

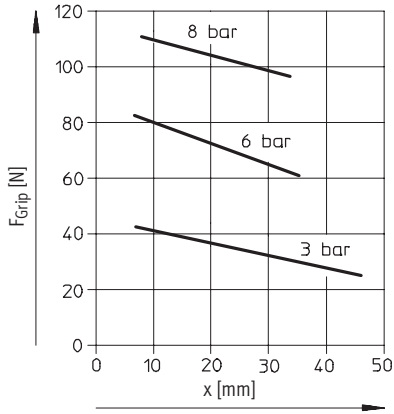

HGDT-35-A

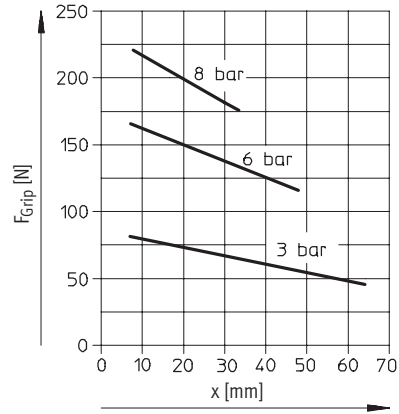

HGDT-40-A

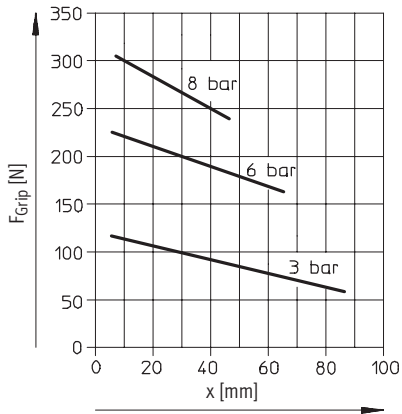

HGDT-50-A

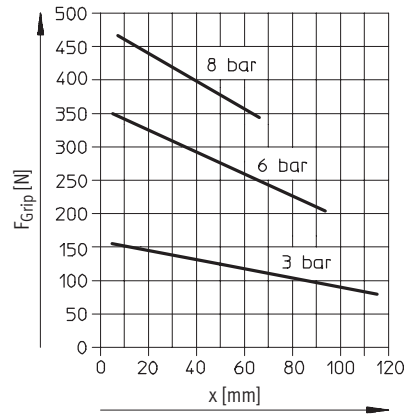

HGDT-63-A

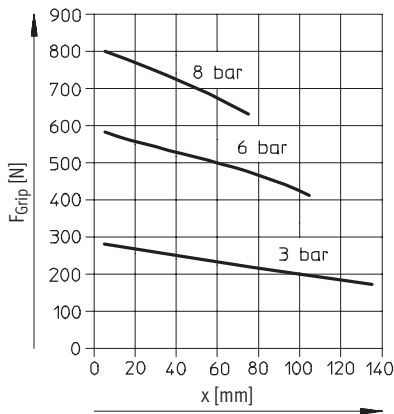

Three-point grippers HGDT, robust

Technical data

Spring force F_F as a function of size, gripper jaw stroke l and gripper length x , per gripper finger

Gripping force retention for HGDT-...-G...

The spring forces F_F as a function of the gripper jaw stroke can be determined from the following chart.

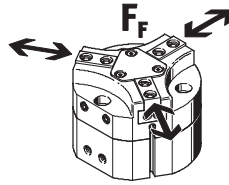

Size 25 ... 63

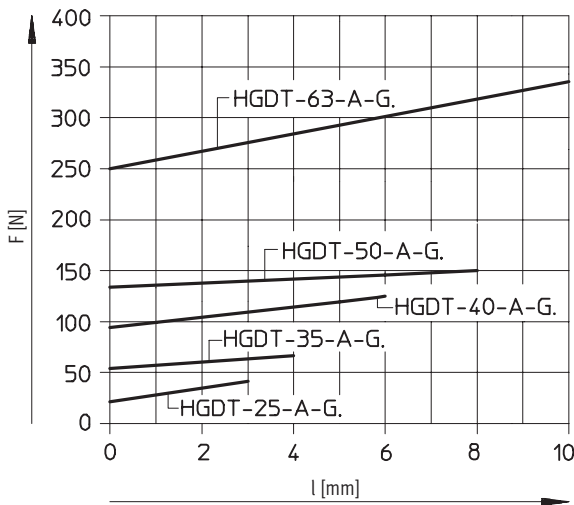

The lever arm x [mm] must be taken into consideration when determining the actual spring force F_{Stotal} .

The formulae for calculating the spring force are provided in the table opposite.

Size	F_{Stotal} , per gripper finger
25	$-0.3 * x + 0.85 * F_{Spring}$
35	$-0.5 * x + 0.75 * F_{Spring}$
40	$-0.5 * x + 0.8 * F_{Spring}$
50	$-0.6 * x + 0.7 * F_{Spring}$
63	$-0.6 * x + 0.75 * F_{Spring}$

Determining the actual gripping forces F_{Gr} for HGDT-...-A-G1 and HGDT-...-A-G2 depending on the application, per gripper finger

The three-point slot grippers with integrated spring type HGDT-...-G1 (opening gripping force retention) and HGDT-...-G2 (closing gripping force retention) can be used as:

- single-acting grippers
- grippers with supplementary gripping force and
- grippers with gripping force retention depending on the requirements.

In order to calculate the available force (F_{Stotal}) must be combined gripping forces F_{Gr} (per gripper finger), accordingly. the gripping force (F_{Grip}) and spring

Application forces per gripper finger

Single-acting	Supplementary gripping force	Gripping force retention
<ul style="list-style-type: none"> • Gripping with spring force: $F_{Gr} = F_{Stotal}$ • Gripping with pressure force: $F_{Gr} = F_{Grip} - F_{Stotal}$ 	<ul style="list-style-type: none"> • Gripping with pressure and spring force: $F_{Gr} = F_{Grip} + F_{Stotal}$ 	<ul style="list-style-type: none"> • Gripping with spring force: $F_{Gr} = F_{Stotal}$

Three-point grippers HGDT, robust

Technical data

Dimensions

Download CAD data → www.festo.com/en/engineering

- 1 Air connection – opening
- 2 Air connection – closing
- 3 Alternative air connection (supplied sealed)
- 4 Sealing air connection (supplied sealed)
- 5 Lubrication nipple (supplied sealed)
- 6 Slot for proximity sensor
- 7 Centring disc

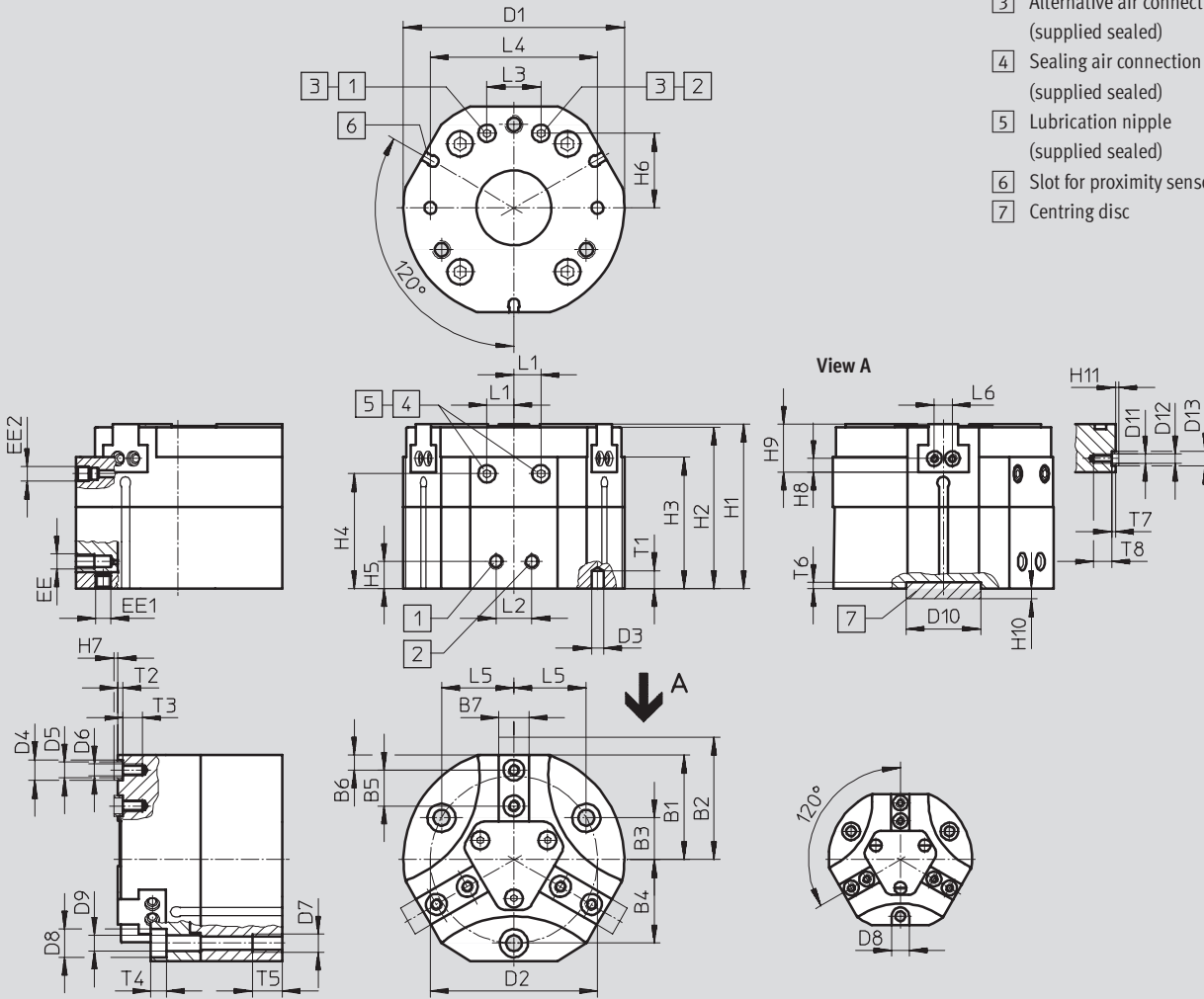

Size	B1	B2	B3	B4	B5	B6	B7	D1	D2	D3	D4	D5
[mm]	±0.5	±0.5			±0.02	±0.02	-0.05 -0.1	∅ ±0.1	∅ ±0.1	∅ H8	∅ H8/h7	∅
HGDT-25-A	22	25	9.5	19	6	3	6	48	38	3	5	3.2
HGDT-25-A-G...												
HGDT-35-A	27	31	11	22	8	4	6.5	58	44	3	5	3.2
HGDT-35-A-G...												
HGDT-40-A	35	41	14	28	12	5	10	74	56	4	7	5.3
HGDT-40-A-G...												
HGDT-50-A	43.5	51.5	17.5	35	15	6	12	93	70	5	9	6.4
HGDT-50-A-G...												
HGDT-63-A	54	64	22.5	45	18	10	14	116	90	5	9	6.4
HGDT-63-A-G...												

Three-point grippers HGDT, robust

Technical data

Size [mm]	D6 ∅	D7 ∅	D8 ∅ H13	D9 ∅ H13	D10 ∅ H8	D11	D12 ∅	D13 ∅ H8/h7	EE	EE1	EE2	H1 ±0.05
HGDT-25-A	M3	M4	5.9	3.3	14	M2	-	-	M5	M3	M5	41.5
HGDT-25-A-G...												
HGDT-35-A	M3	M4	5.9	3.3	25	M3	3.2	5	M5	M3	M5	46
HGDT-35-A-G...												52
HGDT-40-A	M4	M6	9.4	5.1	25	M3	3.2	5	M5	M5	M5	55
HGDT-40-A-G...												72
HGDT-50-A	M6	M8	10.2	6.4	25	M5	5.3	7	G $\frac{1}{8}$	M5	M5	64.5
HGDT-50-A-G...												82
HGDT-63-A	M6	M8	10.4	6.4	25	M5	5.3	7	G $\frac{1}{8}$	M5	M5	69
HGDT-63-A-G...												96

Size [mm]	H2 ±0.05	H3	H4	H5 ±0.1	H6 ±0.1	H7 -0.3	H8	H9 -0.02	H10 -0.2	H11 -0.3	L1 ±0.5	L2 ±0.1
HGDT-25-A	40.5	32.5	29.3	9	13.5	1.1	2.25±0.1	8.5	3.5	-	6	12
HGDT-25-A-G...												
HGDT-35-A	45	37	33.5	9	18.5	1.1	3±0.02	12	3.5	1.1	7	12
HGDT-35-A-G...	51	43	39.5									
HGDT-40-A	54	44	38.4	9	25	1.4	4.5±0.02	16	3.5	1.1	9	12
HGDT-40-A-G...	71	61	55.4									
HGDT-50-A	63.5	50.5	45	12	32	1.9	5.5±0.02	19	3.5	1.4	9	24
HGDT-50-A-G...	81	68	62.5									
HGDT-63-A	68	50	44.5	12	42	1.9	5.5±0.02	22	3.5	1.4	12	24
HGDT-63-A-G...	95	77	71.5									

Size [mm]	L3 ±0.1	L4 ±0.02	L5	L6	T1 min.	T2 +0.1	T3 min.	T4 +0.2	T5 min.	T6 +0.1	T7 +0.1	T8 min.
HGDT-25-A	12	38	16.45	6±0.1	3.5	1.3	5	3.2	8	2	-	3
HGDT-25-A-G...												
HGDT-35-A	15	45	19.05	6±0.02	5	1.3	5.5	3.2	8	2	1.3	6
HGDT-35-A-G...												
HGDT-40-A	18	56	24.25	6±0.02	6	1.6	6.5	5.1	10	2	1.3	6
HGDT-40-A-G...												
HGDT-50-A	18	70	30.31	13±0.02	8	2.1	10.5	6.1	12	2	1.6	9
HGDT-50-A-G...												
HGDT-63-A	24	90	38.97	13±0.02	8	2.1	10.5	6.1	12	2	1.6	9
HGDT-63-A-G...												

Ordering data						
Size [mm]	Double-acting without compression spring			Single-acting or with gripping force retention		
	Part No.	Type		open Part No.	Type	closed Part No.
25	540 859	HGDT-25-A		540 860	HGDT-25-A-G1	540 861 HGDT-25-A-G2
35	540 862	HGDT-35-A		540 863	HGDT-35-A-G1	540 864 HGDT-35-A-G2
40	540 865	HGDT-40-A		540 866	HGDT-40-A-G1	540 867 HGDT-40-A-G2
50	540 868	HGDT-50-A		540 869	HGDT-50-A-G1	540 870 HGDT-50-A-G2
63	540 871	HGDT-63-A		540 872	HGDT-63-A-G1	540 873 HGDT-63-A-G2

Three-point grippers HGDT, robust

Accessories

Unmachined gripper finger

BUB-HGDT

(scope of delivery: 3 pieces)

Material:

Wrought aluminium alloy

Copper, PTFE and silicone-free

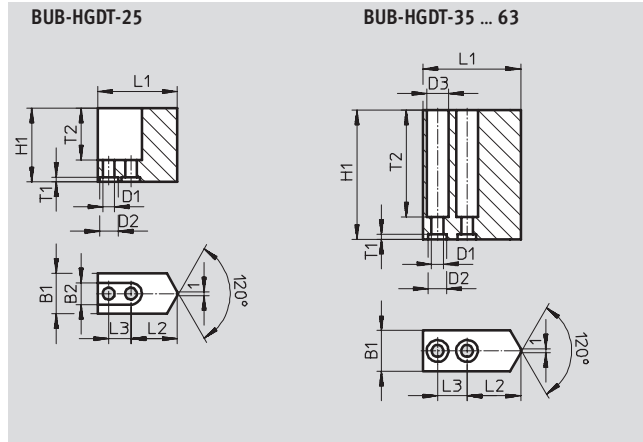

Dimensions and ordering data							
For size	B1	B2	D1	D2	D3	H1	L1
[mm]	±0.05	+0.22	∅ H13	∅ H8	∅ +0.22	±0.05	±0.05
25	11	5.9	3.2	5	-	20	21.6
35	11	-	3.2	5	5.9	35	26.5
40	16	-	4.3	7	7.4	50	34
50	20	-	6.3	9	10.4	65	42
63	24	-	6.3	9	10.4	80	52



For size	L2	L3	T1	T2	Weights per unmachined part [g]	Part No.	Type
[mm]	±0.02 ¹⁾ ±0.1 ²⁾	±0.01 ¹⁾ ±0.1 ¹⁾	+0.1				
25	12.6	6	1.3	14	10	541 101	BUB-HGDT-25
35	14.5	8	1.3	29	22	541 102	BUB-HGDT-35
40	17	12	1.6	45	59	541 103	BUB-HGDT-40
50	21	15	2.1	58	112	541 104	BUB-HGDT-50
63	24	18	2.1	73	222	541 105	BUB-HGDT-63

1) For centring
2) For through-hole

Three-point grippers HGDT, robust

Accessories



FESTO

Ordering data					Technical data → www.festo.com	
	For size [mm]	Remarks	Weights [g]	Part No.	Type	PU ¹⁾
Centring sleeve						
	25, 35	For centring unmachined gripper jaws/gripper fingers on the gripper jaws	1	189 652	ZBH-5	10
	40		1	186 717	ZBH-7	10
	50, 63		1	150 927	ZBH-9	10
	35, 40	For lateral centring of gripper fingers on the gripper jaws	1	189 652	ZBH-5	10
	50, 63		1	186 717	ZBH-7	10
Central mounting						
	25	For centring the gripper when mounting	21	150 900	SLZZ-16/10	–
	35, 40, 50, 63		40	150 901	SLZZ-25/16	–
Blanking plugs						
	25 ... 63	For sealing the compressed air connections	0.6	30 979	B-M3-S9	10
			1	174 308	B-M5-B	10
			5	3 568	B-1/8	10

1) Packaging unit quantity

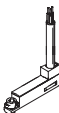
Ordering data – Proximity sensors for rounded slot, longitudinal connecting cable					Technical data → www.festo.com	
	Assembly	Electrical connection		Cable length [m]	Part No.	Type
		Cable	M8 plug			
NO contact, magneto-resistive						
	Insertable from end	–	3-pin	0.3	173 220	SMT-10-PS-SL-LED-24
		3-wire	–	2.5	173 218	SMT-10-PS-KL-LED-24

Ordering data – Proximity sensors for rounded slot, lateral connecting cable					Technical data → www.festo.com	
	Assembly	Electrical connection		Cable length [m]	Part No.	Type
		Cable	M8 plug			
NO contact, magneto-resistive						
	Insertable from end	3-wire	–	2.5	173 219	SMT-10-PS-KQ-LED-24
		–	3-pin	0.3	173 221	SMT-10-PS-SQ-LED-24

Ordering data – Plug socket with cable					Technical data → www.festo.com		
	Assembly	Switch output		Connection	Cable length [m]	Part No.	Type
		PNP	NPN				
Straight plug socket							
	M8 union nut	■	■	3-pin	2.5	159 420	SIM-M8-3GD-2,5-PU
		■	■		5	159 421	SIM-M8-3GD-5-PU
Angled plug socket							
	M8 union nut	■	■	3-pin	2.5	159 422	SIM-M8-3WD-2,5-PU
		■	■		5	159 423	SIM-M8-3WD-5-PU

Aspects of quality

Quality can be viewed from a number of aspects. A short virtual tour of the Research and Development department, the Production department or the Customer Service Centre speaks more than a thousand words.

3D engineering and simulation

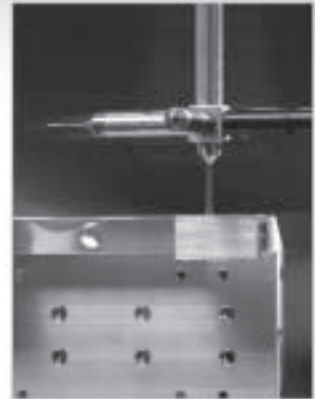

Innovation quality

Let's look at some of the figures:

- 6.5% of turnover
- 2,800 patents with 100 new applications every year
- 3D engineering and simulation
- 10,600 employees worldwide
- Each and every one of them a lateral thinker

Production quality

Your interest is quality and economy – therefore we place considerable value on:

- Minimum production tolerances
- Ultra-modern, proprietary production methods
- Core competencies in production
- Defined quality standards across the entire production chain
- Strict quality assurance systems: on that you can depend.



Price quality

More service for less money. Many of the new and further developments in the Festo product range have one thing in common: they are technically superior and more attractively priced than their predecessor product. Examples are to be found in all product segments: among the drives, valves, valve terminals; among the service units, and among the range of accessories.



Range quality

For individual solutions. Festo offers components as industry-specific catalogue products as well as standards-based and highly individual special designs. Ready-to-install combinations of these components play an integral part in the Festo product portfolio as modules or systems. Incidentally, an increasing number of components can be individually configured as modular products.



Didactic quality

To complement the products and services for automation, Festo Didactic offers exceptionally efficient training hardware, learning software and seminars of the highest quality. Optimally tailored to your value creation sequence. In short – training in practical applications for practical application.

Products and services – everything from a single source

Products incorporating new ideas are created when enthusiasm for technology and efficiency come together. Tailor-made service goes without saying when the customer is the focus of attention.



Pneumatic and electrical drives

- Pneumatic cylinders
- Semi-rotary drives
- Handling modules
- Servopneumatic positioning systems
- Electromechanical drives
- Positioning controllers and controllers



Valves and valve terminals

- Standard valves
- Universal and application-optimised valves
- Manually and mechanically actuated valves
- Shut-off, pressure control and flow control valves
- Proportional valves
- Safety valves

Fieldbus systems/ electrical peripherals

- Fieldbus Direct
- Installation system CP/CPI
- Modular electrical terminal CPX



Compressed air preparation

- Service unit combinations
- Filter regulators
- Filters
- Pressure regulators
- Lubricators
- On-off and soft-start valves
- Dryers
- Pressure amplifiers
- Accessories for compressed air preparation

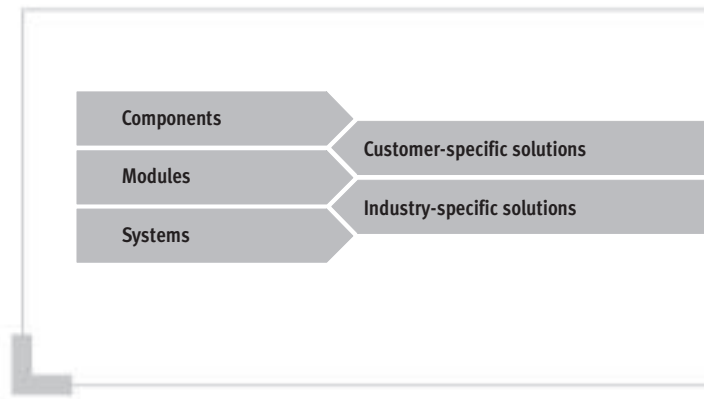

Services from Festo to increase your productivity – across the entire value creation sequence



Engineering – for greater speed in the development process

- CAD models
- 14 engineering tools
- Digital catalogue
- FluidDRAW®
- More than 1,000 technical consultants and project engineers worldwide
- Technical hotlines



Supply chain – for greater speed in the procurement process

- E-commerce and online shop
- Online order tracking
- Euro special manufacturing service
- Logistics optimisation



Gripping and vacuum technology

- Vacuum generators
- Vacuum grippers
- Vacuum security valves
- Vacuum accessories
- Standard grippers
- Micro grippers
- Precision grippers
- Heavy-duty grippers



Sensors and monitoring units

- Proximity sensors
- Pressure and flow sensors
- Display and operating units
- Inductive and optical proximity sensors
- Displacement encoders for positioning cylinders
- Optical orientation detection and quality inspection

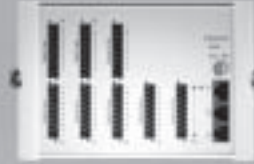

Controllers/bus systems

- Pneumatic and electropneumatic controllers
- Programmable logic controllers
- Fieldbus systems and accessories
- Timers/counters
- Software for visualisation and data acquisition
- Display and operating units



Accessories

- Pipes
- Tubing
- Pipe connectors and fittings
- Electrical connection technology
- Silencers
- Reservoirs
- Air guns

All in all, 100% product and service quality

A customer-oriented range with unlimited flexibility: Components combine to produce ready-to-install modules and systems. Included in this are special designs – since at Festo, most industry-specific products and customer-specific solutions are based on the 23,000 plus catalogue products. Combined with the services for the entire value creation sequence, the end result is unbeatable economy.



Assembly – for greater speed in the assembly/commissioning process

- Prepack
- Preassembly
- Turnkey pneumatics
- Handling solutions



Operation – for greater speed in the operational process

- Spare parts service
- Energy saving service
- Compressed air consumption analysis
- Compressed air quality analysis
- Customer service

What must be observed when using Festo components?

Specified limit values for technical data and any specific instructions must be adhered to by the user in order to ensure recommended operating conditions.

When pneumatic components are used, the user shall ensure that they are operated using correctly prepared compressed air without aggressive media.

When Festo components are used in safety-oriented applications, the user shall ensure that all applicable

national and local safety laws and regulations, for example the machine directive, together with the relevant references to standards are observed. Unauthorised conversions or modifications to products and systems from Festo involve a safety risk and are thus not permissible.

Festo does not accept any liability for resulting damages.

You should contact Festo's advisors if one of the following apply to your application:

- The ambient conditions and conditions of use or the operating medium differ from the specified technical data.
- The product is to perform a safety function.
- A risk or safety analysis is required.
- You are unsure about the product's suitability for use in the planned application.
- You are unsure about the product's suitability for use in safety-oriented applications.

All technical data applies at the time of going to print.

All texts, representations, illustrations and drawings included in this catalogue are the intellectual property of Festo AG & Co. KG, and are protected by copyright law.

All rights reserved, including translation rights. No part of this publication may be reproduced or transmitted in any form or by any means, electronic, mechanical, photocopying or otherwise, without the prior written permission of Festo AG & Co. KG. All technical data subject to change according to technical update.