



Electrolux

INDUSTRIJA ZA EL.GREAO
I GUMENI PROIZVODI

Ovaj crtez e sopstvenost na Electrolux-Bitola.Bez negovo pismeno odobruvanje istiot nesmee da se prepisuva , umnozuva niti kopira .bez soglasnost od Electroluks vo sproftivno se snosaf posledici vo smisla na clenovite 163 i 164 od krivicniot zakon R.M. (povreda na avtorsko pravo)

Керамички Производи

Керамички proizvodi

Adresa: ul.Braka Mingovi 18, 7000 Bitola; tel: 047/203-330 ,203 900ul.A.Guslarot.1a 02/329 8 130 Skopje

www.elektroluks.com. e-mail: elek-palenzo@mt.net.mk



Electrolux

INDUSTRIJA ZA EL. GREAO
GUMENI PROIZVODI

Halsperlen
interlocking beads
perles á emboitement
perlas de cuello

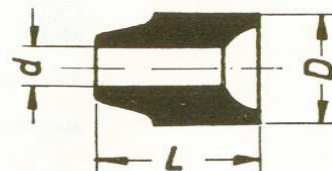

	Art. Nr.	D	d	L	Stück auf 1 kg ca.	1 kg isoliert ca. m
	6203/12	4,1	1,6	6,0	7700	39,5
	6203/0	5,0	2,3	5,3	6900	28,0
	6303/1	5,9	2,6	6,2	4160	18,9
	6203/1a DIN 44932/6,5	6,5	3,2	6,0	3670	17,8
	6203/10	7,0	2,8	6,6	3850	18,8
	6203/4a	7,8	3,8	7,7	2300	12,7
	6203/4 DIN 44932/8	8,0	3,8	7,0	2350	12,6
	6303/4b	8,0	3,8	7,7	2000	13,0
	6203/2	8,5	3,4	8,5	1585	9,7
	6203/9	8,5	4,6	7,5	2400	13,4
	6303/13 DIN 44932/9	9,0	4,6	8,0	1375	9,4

Ovaj crtež e sopstvenost na Electrolux-Bitola.Bez negovo pismeno odobruvanje istiot nesmee da se prepisuva , umnozuva niti kopira . bez soglasnost od Electroluks vo sproftivo se snosaf posledici vo smisla na clenovite 163 i 164 od kriticniot zakon R.M. (povreda na avtorsko pravo)

Adresa: ul.Braka Mingovi 18, 7000 Bitola; tel: 047/203-330 ,203 900ul.A.Guslarot.1a 02/329 8 130 Skopje

www.elektroluks.com. e-mail: elek-palenzo@mt.net.mk

1002



Electrolux

INDUSTRIJA ZA EL. GREAO
GUMENI PROIZVODI

Halsperlen
interlocking beads
perles á emboitement
perlas de cuello

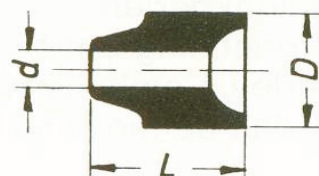

	Art. Nr.	D	d	L	Stück auf 1 kg ca.	1 kg isoliert ca. m
	6303/3b	9,4	3,9	10	1180	8,0
	6203/2a	9,5	3,5	9,4	1000	7,75
	6303/3	9,5	3,9	10	1160	7,7
	6203/8a	9,5	4,9	8,0	1410	8,92
	6303/11	9,9	6,2	10,5	1100	8,0
	6303/5 DIN 44932/10,5	10,5	6,3	9,0	1170	8,0
	6303/6	13	7,0	9	725	4,7
	6303/7	16,5	11,5	12	370	3,6
	6003/8	19	13,5	12	300	3,0

Ovaj crtež e sopstvenost na Electrolux-Bitola.Bez negovo pismeno odobruvanje istiot nesmee da se prepisuva , umnozuva niti kopira .bez soglasnost od Electroluks vo sproftivo se snosaf posledici vo smisla na clenovite 163 i 164 od kriticniot zakon R.M. (povreda na avtorsko pravo)

Adresa: ul.Braka Mingovi 18, 7000 Bitola; tel: 047/203-330 ,203 900ul.A.Guslarot.1a 02/329 8 130 Skopje

www.elektroluks.com. e-mail: elek-palenzo@mt.net.mk

1003



Electrolux

INDUSTRIJA ZA EL. GREAO
GUMENI PROIZVODI

Gelenkperlen
interlocking beads
perles á emboitement
perlas de movimiento

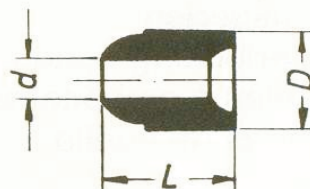

	Art. Nr.	D	d	L	Stück auf 1 kg ca.	1 kg isoliert ca. m
	6202/0	3,0	1,0	3,1	28000	67,5
	6302/5	5,0	2,5	5,0	6650	28,2
	6202/8	6,5	4,2	7,6	3000	21
	6202/6	6,6	3,0	7,0	3000	17,5
	6202/1	6,7	3,2	7,2	2800	17,0
	6302/9	7,5	3,8	8,1	2000	14,23
	6302/7	8,1	3,2	8,2	1600	10,6
	6202/11	8,3	5,0	9,1	1050	8,50
	6302/2	8,4	4,7	8,3	1650	11,6
	6202/10	8,5	5,3	9,0	1520	12,64

Ovaj cifrez e sopstvenost na Electrolux-Bitola.Bez negovo pismeno odobruvanje istiot nesmee da se prepisuva , umnozuva niti kopira .bez soglasnost od Electroluks vo sproftivno se snosaf posledici vo smisla na clenovite 163 i 164 od kriticniot zakon R.M. (povreda na avtorsko pravo)

Adresa: ul.Braka Mingovi 18, 7000 Bitola; tel: 047/203-330 ,203 900ul.A.Guslarot.1a 02/329 8 130 Skopje

www.elektroluks.com. e-mail: elek-palenzo@mt.net.mk

1004



ЕЛЕКТРОЛУКС

INDUSTRIJA ZA EL. GREAO GUMENI PROIZVODI

Ovaj crtez e sopstvenost na Electrolux-Bitola.Bez negovo pismeno odobruvanje istiot nesmee da se prepisuva , umnozuva niti kopira .bez soglasnost od Elcitoluks vo sproftivno se snosat posledici vo smisla na clenovite 163 i 164 od krivicniot zakon R.M. (povreda na avtorsko pravo)

Gelenkperlen
interlocking beads
perles á emboitement
perlas de movimiento

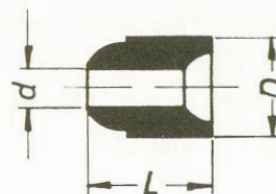

	Art. Nr.	D	d	L	Stück auf 1 kg ca.	1 kg isoliert ca. m
	6202/12	8,5	5,5	7,9	2000	13,8
	6202/2b	8,7	5,0	7,5	1750	11,40
	6202/14	9,0	5,0	9,4	1420	9,9
	6202/4a	9,8	6,3	10	950	8,35
	6302/4	9,9	6,2	9,2	1080	8,9

Adresa: ul.Braka Mingovi 18, 7000 Bitola; tel: 047/203-330 ,203 900ul.A.Guslarot.1a 02/329 8 130 Skopje

www.elektroluks.com. e-mail: elek-palenzo@mt.net.mk



ЕЛЕКТРОЛУКС

INDUSTRIJA ZA EL. GREACI GUMENI PROIZVODI

Becherperlen
interlocking beads
perles á emboitement
perlas de tasa

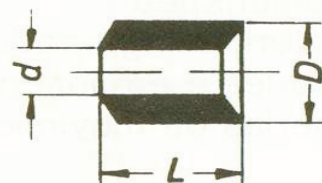

	Art. Nr.	D	d	L	Stück auf 1 kg ca.	1 kg isoliert ca. m
	6201/0	4,3	2,2	4,5	9600	37,8
	6201/1a	6,0	2,8	6,5	3000	17,5
	6201/1	6,6	3,1	6,6	2500	15,5
	6201/2	8,4	4,7	7,7	1600	10,9
	6201/3	8,6	5,3	8,0	1600	11,5
	6201/6	14,0	7,1	8,0	550	3,5

Ovaj crtez e sopstvenost na Electrolux-Bitola.Bez negovo pismeno odobruvanje istiot nesmee da se prepisuva , umnozuva niti kopira .bez soglasnost od Elcitoluks vo sproftivno se snosaf posledici vo smisla na clenovite 163 i 164 od krivicniot zakon R.M. (povreda na avtorsko pravo)

Adresa: ul.Braka Mingovi 18, 7000 Bitola; tel: 047/203-330 ,203 900ul.A.Guslarot.1a 02/329 8 130 Skopje

www.elektroluks.com. e-mail: elek-palenzo@mt.net.mk



Electrolux

INDUSTRIJA ZA EL. GREAO
I GUMENI PROIZVODI

Ovaj crtez e sopstvenost na Electrolux-Bitola.Bez negovo pismeno odobruvanje istiot nesmee da se prepisiva , umnozuva niti kopira .bez soglasnost od Electroluks vo sproftivo se snosaf posledici vo smisla na clenovite 163 i 164 od kriticniot zakon R.M. (povreda na avtorsko pravo)

Zylinderperlen
cylindrical beads
perles cylindriques
perlas sylicndricas

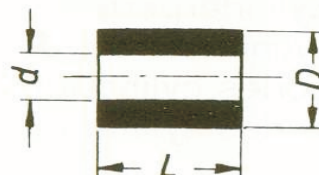

	Art. Nr.	D	d	L	Stück auf 1 kg ca.	1 kg isoliert ca. m
	6206/00	2,0	0,6	4,0	37000	45,0
	6206/11	3,0	1,3	6,0	13400	79,0
	6206/0	4,3	1,8	4,3	8000	35,5
	6206/14	4,75	3,2	4,35	8500	36,5
	6306/27	5,0	3,1	4,15	6250	25,9
	6206/1	5,2	2,5	5,0	4800	23,8
	6306/17	5,5	3,05	5,0	4000	20
	6206/9	6,0	4,0	4,0	6600	26,2
	6306/22	6,0	3,85	8	2780	22,9
	6306/21	6,6	3,85	8	2444	19,50

Adresa: ul.Braka Mingovi 18, 7000 Bitola; tel: 047/203-330 ,203 900ul.A.Guslarot.1a 02/329 8 130 Skopje

www.elektroluks.com. e-mail: elek-palenzo@mt.net.mk



Electrolux

INDUSTRIJA ZA EL. GREJAO
I GUMENI PROIZVODI

Zylinderperlen
cylindrical beads
perles cylindriques
perlas sylindricas

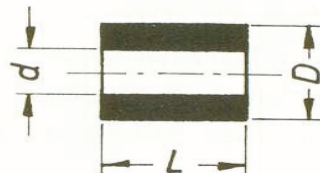

	Art. Nr.	D	d	L	Stück auf 1 kg ca.	1 kg isoliert ca. m
	6206/8	6,8	5,0	10,0	2500	24,8
	6206/2	6,9	3,3	6,7	2150	14,3
	6206/10	7,0	2,8	10	1300	12,8
	6206/12	7,0	4,45	5,7	2850	16,0
	6206/13	7,0	4,0	5,7	2600	15,9
	6306/13a	7,13	3,96	5,66	2380	13,50
	6206/20	7,39	4,32	5,66	2440	13,80
	6306/26	7,49	4,14	5,46	2300	12,60
	6206/16	7,5	3,85	5,0	2500	12,50
	6206/7	7,8	6,0	10,0	2000	19,5

Ovaj cifre e sopstvenost na Electrolux-Bitola.Bez negovo pismeno odobruvanje istiot nesmee da se prepisuva , umnozuva niti kopira .bez soglasnost od Electroluks vo sproftivo se snosaf posledici vo smisla na clenovite 163 i 164 od krivicniot zakon R.M. (povreda na avtorsko pravo)

Adresa: ul.Braka Mingovi 18, 7000 Bitola; tel: 047/203-330 ,203 900ul.A.Guslarot.1a 02/329 8 130 Skopje

www.elektroluks.com. e-mail: elek-palenzo@mt.net.mk



Electrolux

INDUSTRIJA ZA EL. GREAO
I GUMENI PROIZVODI

Ovaj crtež e sopstvenost na Electrolux-Bitola.Bez negovo pismeno odobruvanje istiot nesmee da se prepisuva , umnozuva niti kopira .bez soglasnost od Electroluks vo sproftivno se snosaf posledici vo smisla na clenovite 163 i 164 od kriticniot zakon R.M. (povreda na avtorsko pravo)

Zylinderperlen
cylindrical beads
perles cylindriques
perlas syilndricas

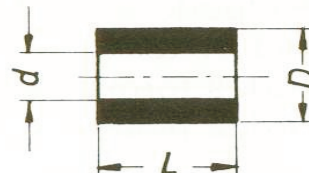

	Art. Nr.	D	d	L	Stück auf 1 kg ca.	1 kg isoliert ca. m
	6206/15	8,0	4,3	8,6	1335	11,50
	6206/15a	8,0	4,3	9,1	1330	12,25
	6206/3	8,2	4,3	8,0	1325	10,4
	6206/24	8,8	5,5	9,5	1300	12,05
	6206/24a	8,8	5,5	14,5	870	12,50
	6206/6	10,0	4,0	10,0	615	6,0
	6906/23	10,0	5,0	9,0	715	6,44
	6206/4	12,0	7,8	10,0	600	5,9
	6206/5	12,4	6,6	8,8	550	4,7

Adresa: ul.Braka Mingovi 18, 7000 Bitola; tel: 047/203-330 ,203 900ul.A.Guslarot.1a 02/329 8 130 Skopje

www.elektroluks.com. e-mail: elek-palenzo@mt.net.mk



Electrolux

INDUSTRIJA ZA EL. GREAO
I GUMENI PROIZVODI

Endperlen
end beads
perles terminales
perlas finales

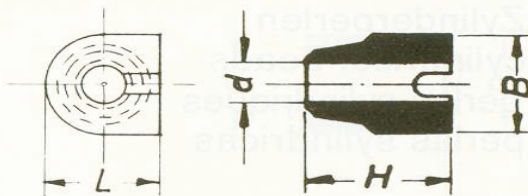

	Art. Nr.	d	L	B	H	Stück auf 1 kg ca.
	6209/6 C 6,5 DIN 44932	2,0	6,5	6,5	6,0	2200
	6309/4	2,0	8,0	8,5	10,5	1050
	6209/7	2,0	14,0	12,0	11,0	333
	6209/8	2,0	14,0	12,0	11,0	312
	6209/1 C 9 DIN 44932	2,5	9,0	9,0	8,0	1040
	6209/2	3,5	6,5	7,2	6,5	2200

Ovaj crtež e sopstvenost na Electrolux-Bitola.Bez negovo pismeno odobruvanje istiot nesmee da se prepisuva , umnozuva niti kopira . bez soglasnost od Electroluks vo sproftivo se snosaf posledici vo smisla na clenovite 163 i 164 od krivicniot zakon R.M. (povreda na avtorsko pravo)

Adresa: ul.Braka Mingovi 18, 7000 Bitola; tel: 047/203-330 ,203 900ul.A.Guslarot.1a 02/329 8 130 Skopje

www.elektroluks.com. e-mail: elek-palenzo@mt.net.mk



Electrolux

INDUSTRIJA ZA EL. GREAO
I GUMENI PROIZVODI

Ovaj crtez e sopstvenost na Electrolux-Bitola.Bez negovo pismeno odobruvanje istiot nesmee da se prepisuva , umnozuva niti kopira .bez soglasnost od Eictroluks vo sproftivno se snosaf posledici vo smisla na clenovite 163 i 164 od krivicniot zakon R.M. (povreda na avtorsko pravo)

Isolierperlen
insulating beads
perles isolantes
perlas isoladoras

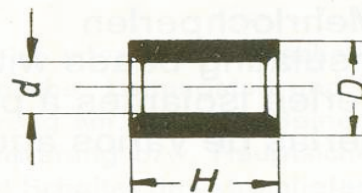

	Art. Nr.	D	d	L	B	H	Stück auf 1 kg ca.	1 kg isol. ca. m
Vierkantperle 	6208/1		3,0	6,0 x 6,0		5,5	2290	12,7
Vierkantperle 	6208/2		4,0	8,5 x 8,5		7,5	935	7,0
Wendeperle 	6207/1	8,2	4,6	7,7			1600	—
Wendeperle 	6207/0	4,5	1,8	5,8			6660	—

Adresa: ul.Braka Mingovi 18, 7000 Bitola; tel: 047/203-330 ,203 900ul.A.Guslarot.1a 02/329 8 130 Skopje

www.elektroluks.com. e-mail: elek-palenzo@mt.net.mk



Electrolux

INDUSTRIJA ZA EL. GREJAO
I GUMENI PROIZVODI

Ovaj crtež e sopstvenost na Electrolux-Bitola.Bez negovo pismeno odobruvanje istiot nesmee da se prepisuva , umnozuva niti kopira .bez soglasnost od Electroluks vo sproftivno se snosaf posledici vo smisla na clenovite 163 i 164 od krivicniot zakon R.M. (povreda na avtorsko pravo)

Mehrlochperlen
insulating beads with multiples holes
perles isolantes á plusieurs trous
perlas de varios agujeros

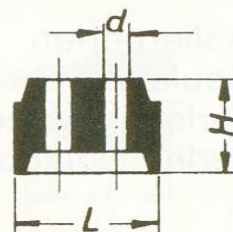

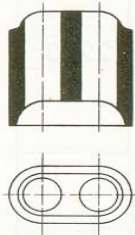
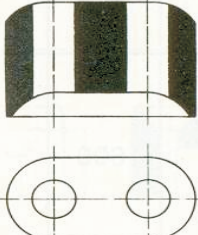
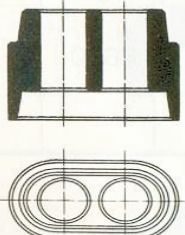
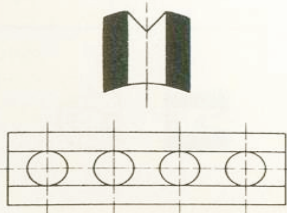
	Art. Nr.	d	L	B	H	Stück auf 1 kg ca.
Zweilochperle 	6304/6	4,0	13,0	7,0	14,0	570
Zweilochperle 	6204/1	4,6	20,0	10,2	14,0	245
Zweilochperle 	6304/7	4,5	18	10	25	157
	6304/7a	4,5	18	10	13,5	350
Vierlochperle 	6205	4,2	29,5	9,0	10,0	212

Adresa: ul.Braka Mingovi 18, 7000 Bitola; tel: 047/203-330 ,203 900ul.A.Guslarot.1a 02/329 8 130 Skopje

www.elektroluks.com. e-mail: elek-palenzo@mt.net.mk



Electrolux

INDUSTRIJA ZA EL. GREČKI
I GUMENI PROIZVODI

Ovaj crtež e sopstvenost na Electrolux-Bitola. Bez negovo pismeno odobruvanje istiot nesmee da se prepisuva , umnozuva niti kopira . bez soglasnost od Elctroluks vo sproftivo se snosaf posledici vo smisla na clenovite 163 i 164 od krivicniot zakon R.M. (povreda na avtorisko pravo)

Sonderliste – Isolierperlenstränge für Dachständer-Einführungen

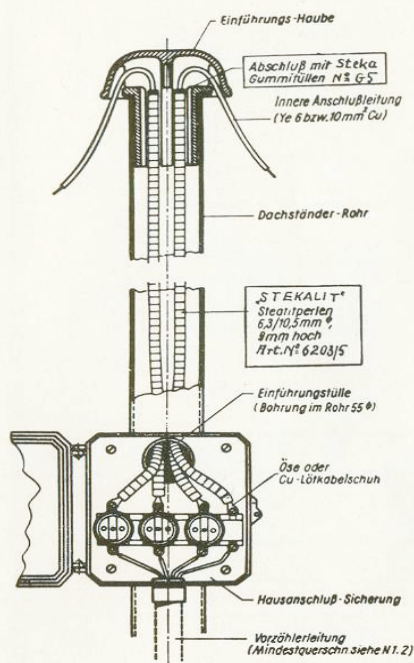

Erfahrungsgemäß ist speziell der Dachständer ein schwer zugänglicher Leitungsteil und hängt direkt ohne Sicherung am Ortsnetz. Seine Lage zwischen Panzersicherung bzw. Hauptsicherung des Gebäudes und Schalter des stromliefernden E-Werkes bedingt es, daß ein Schadhafwerden nur sehr schwer feststellbar ist und man nur durch Abriegeln verschiedener Straßenzüge und letzten Endes Häuserblocks zu dem schadhaf gewordenen Dachständer hinfindet.

Aus diesem Grunde erscheint es zweckmäßig, von vornherein die stromführenden Leiter im Dachständer voneinander vor allem durch unbrennbare zusätzliche Isolation zu distanzieren. Die Unbrennbarkeit der zusätzlichen Isolation ist vor allem von besonderer Bedeutung, weil sie auch im Falle eines Blitzschlages wirksam bleibt und der elektrische Lichtbogen, z. B. an der keramischen Ummantelung, **bestehend aus Steatitperlen**, ablöscht.

1. Isolierung von blankem Kupferdraht mit Steatitperlen (alternativ ummantelte Perlenschläuche in den Phasenfarben Grün, Gelb und Violett sowie Grau für den Null-Leiter)

für 6 mm² Cu (∅ 2.76 mm)

Art.-Nr. 6203/3 P Perlengröße ∅ 9.4 mm, Bohrung 3.9 mm, Höhe 10.0 mm

für 10 mm² Cu (∅ 3.75 mm)

Art.-Nr. 6203/4 P Perlengröße ∅ 8.0 mm, Bohrung 3.8 mm, Höhe 7.0 mm

für 16 mm² Cu (∅ 4.51 mm)

Art.-Nr. 6203/5 P Perlengröße ∅ 10.5 mm, Bohrung 6.3 mm, Höhe 9.0 mm

für 25 mm² Cu (∅ 6.45 mm)

Art.-Nr. 6203/6 P Perlengröße ∅ 13.0 mm, Bohrung 7.0 mm, Höhe 9.0 mm

2. Isolierung für YE- oder YM-Draht mit Steatitperlen (alternativ ummantelte Perlenschläuche in den Phasenfarben Grün, Gelb, Violett sowie Grau für den Null-Leiter)

für 6 mm² Cu

Art.-Nr. 6203/5 P Perlengröße ∅ 10.5 mm, Bohrung 6.3 mm, Höhe 9.0 mm

für 10 mm² Cu

Art.-Nr. 6203/6 P Perlengröße ∅ 13.0 mm, Bohrung 7.0 mm, Höhe 9.0 mm

für 16 mm² Cu

Art.-Nr. 6203/7 P Perlengröße ∅ 16.5 mm, Bohrung 11.5 mm, Höhe 12.0 mm

Adresa: ul.Braka Mingovi 18, 7000 Bitola; tel: 047/203-330 ,203 900ul.A.Guslarot.1a 02/329 8 130 Skopje

www.elektroluks.com. e-mail: elek-palenzo@mt.net.mk



Electrolux

INDUSTRIJA ZA EL. GREČKI
I GUMENI PROIZVODI

Ovaj crtež e sopstvenost na Electrolux-Bitola.Bez negovo pismeno odobruvanje istiot nesmee da se prepisuva , umnozuva niti kopira .bez soglasnost od Electroluks vo sproftivno se snosaf posledici vo smisla na clenovite 163 i 164 od krivicniot zakon R.M. (povreda na avtorsko pravo)

Einzelbuchsen Single bushes Passes fils simples					Gegenringe Counter bushes Passes fils femelles				
Art. Nr.	D	d	d_1	d_2	H	h	h_1	h_2	Art. Nr.
6226/3	7	5,5	3,2		5	2	3		
	9	6	3,2		4	2	2		6231/3
6366/56	12	7,5	5,15		6,5	3,5	3		
	12	8,2	5,15		6,5	2,7	3,8		6330/26
6326/21	12,25	7,7	3,45	5,8	7,5	3	4,5	0,5	
6326/19	12,7	6,75	3,35	7,1	3,8	2,28	1,52	1	
6366/54	12,7	6,75	3,35		3,8	2,28	1,52		
6226/1	13,5	8,5	4,5	8,5	10	5	5	2	
	13,5	9,5	4,5		8	2,5	5,5		6231/1
6226/4	13,5	7,5	4,5	7,5	11	7	4	2	
	13,5	8	4,5		7	3	4		6231/4
6325/f	13,6	8	4,5	8,5	10,5	5,5	5	2	
6226/6	15,6	13,5	5,3	7,4SW	4,9	4	0,9	1,2	
6226/6A	15,6	13,5	5,3	7,4SW	5,4	4	1,4	1,2	
6225/b	16	9	5,2		6	4	2		
	16	9,5	5,5		6	2,5	3,5		6230/1
6325/e	16	11,8	7x1,5		11	6	5		
	16	12,7	7x1,5		8	3	5		6330/21

Adresa: ul.Braka Mingovi 18, 7000 Bitola; tel: 047/203-330 ,203 900ul.A.Guslarot.1a 02/329 8 130 Skopje

www.elektroluks.com. e-mail: elek-palenzo@mt.net.mk



Electrolux

INDUSTRIJA ZA EL. GREJAO
I GUMENI PROIZVODI

Ovaj crtez e sopstvenost na Electrolux-Bitola.Bez negovo pismeno odobruvanje istiot nesmee da se prepisuva , umnozuva niti kopira .bez soglasnost od Electroluks vo sproftivo se snosaf posledici vo smisla na clenovite 163 i 164 od krivicniot zakon R.M. (povreda na avtorsko pravo)

Einzelbuchsen Single bushes Passes fils simples					Gegenringe Counter bushes Passes fils femelles				
Art. Nr.	D	d	d ₁	d ₂	H	h	h ₁	h ₂	Art. Nr.
6226/2	16	8,6	5,3	10,5	9,2	5,5	3,7	2,5	
	16	9,3	5,3		7	3	4		6231/2
6226/2a	16	8,6	5,3	7,5SW	9,2	5,5	3,7	3	
	16	9,3	5,3		7	3	4		6231/2
6526/10	16	8,6	5,3	10,5	11	6,65	4,35	2,5	
	16	9,2	5,3		8	4	4		6231/2a
6325/a	16,5	9,5	5,3		9	5	4		
	16	9,5	5,5		6	2,5	3,5		6230/1
6325	16,5	9,5	5,3		8	4	4		
	16	10,5	5,5		7,5	3	4,5		6330
6325 g	18	10	6	10	11	5	6	1	
6325 h	19	9,7	5,25		10	5	5		
6226/8	21	11,5	6	14	34	15	19	7,5	
	21	12,5	6		24,5	5	19,5		6230/14
6327/3	22	12	7		13	7	6		
	22	13	7		11	4	7		6330/3
6327/3A	22	12	7		14	7	7		
	22	13	7		11	4	7		6330/3
6327/3B	22	12	7		15	7	8		
	22	13	7		11	4	7		6330/3
6227/4	24	□12	6,5□		13	7	6		
	24	□12,5	6,5□		11	5,5	5,5		6230/4

Adresa: ul.Braka Mingovi 18, 7000 Bitola; tel: 047/203-330 ,203 900ul.A.Guslarot.1a 02/329 8 130 Skopje

www.elektroluks.com. e-mail: elek-palenzo@mt.net.mk



Electrolux

INDUSTRIJA ZA EL. GREJANJE I GUMENI PROIZVODI

Ovoj crtez e sopstvenost na Electrolux-Bitola.Bez negovo pismeno odobruvanje istiot nesmee da se prepisuva , umnozuva niti kopira .bez soglasnost od Electroluks vo sproftvno se snosaf posledici vo smisla na clenovite 163 i 164 od kriticniot zakon R.M. (povreda na avtorsko pravo)

Einzelbuchsen Single bushes Passes fils simples					Gegenringe Counter bushes Passes fils femelles				
Art. Nr.	D	d	d_1	d_2	H	h	h_1	h_2	Art. Nr.
6227/5	30	17,8	9,65		28,5	16,5	12		
	30	19,4	9,65		20	9,3	10,7		6230/5
6227/11	30	16	8,65		15	8	7		
	30	18,2	8,65		15	7	8		6230/16
6327/13	30	9,8	5		8,5	4,5	4		
6366/55	35,65	26,55	18,65		12,35	4,15	8,2		
6227/6	36	22,25	11,7		26	14	12		
	36	23,75	11,7		20	10	10		6230/6
8227/10	40	24	13		28	12	16		

Adresa: ul.Braka Mingovi 18, 7000 Bitola; tel: 047/203-330 ,203 900ul.A.Guslarot.1a 02/329 8 130 Skopje
 www.elektroluks.com. e-mail: elek-palenzo@mt.net.mk



Electrolux

INDUSTRIJA ZA EL. GREAO
I GUMENI PROIZVODI

Einzelbuchsen
Single bushes
Passes fils simples

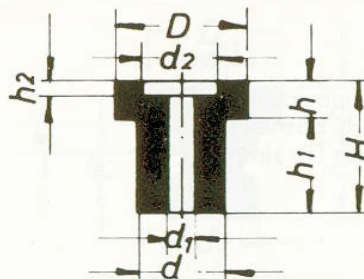

Art. Nr.	D	d	d_1	d_2	H	h	h_1	h_2
6366/18	6	4,5	2,4		10	6	4	
6266/24	6,7	5,3	3,2		10	6	4	
6266/24 a	6,7	5,3	3,2		8,5	5,85	2,65	
6266/24 b	6,7	5,3	3,2		5,7	3,2	2,5	
6266/49	6,7	4,3	2,3		12	6	6	
6366/5	6,75	4,8	2,65		10	3	7	
6266/45	7,5	6	2,6		9	5	4	
6266/50	7,8	5,6	3,5		12	6	6	
6266/31	7,9	5,9	3,35		9	5	4	
6266/41	8	6,5	3,15		5,5	5	0,5	
6366/22 b	8,1	6	4,1		10	6	4	
6366/52	8,2	6,4	3,85		8,2	4,2	4	
6266/35	8,1	6	3,6		10	6	4	
6266/15	8,1	5,85	4,25		9	5	4	
6266/48	8,3	5,9	4,1		10	5	5	
6266/48 a	8,3	5,9	2,3		10	5	5	
6266/22	8,4	6	4,1		10	6	4	
6266/25	8,5	6,6	4,2		8,5	6	2,5	
6366/53	8,5	6,05	3,35		9	4	5	
6366/9	8,8	6,5	4,2		10	6	4	
6366/42	8,8	6,5	1,7		10	6	4	
6266/20	9	7	3,95		8	5,5	2,5	
6366/10	8,9	6,5	3,1		10,5	3	7,5	
6366/8	9	6,5	3		12	5	7	
6266/40	9	7,5	4,15		5,5	5	0,5	
6266/26	10	7,75	3,3		11	5	6	
6225/c	10	7	4		6	2	4	
6225/d	10	7	4,25		7,2	6	1,2	
6326/11	10	6,2	4,3	7,3	5,2	3,7	1,5	1,6
6326/11 a	10	6,2	4,3	7,3	5,9	3,7	2,2	1,6

Ovaj crtez e sopstvenost na Electrolux-Bitola.Bez negovo pismeno odobruvanje istiot nesmee da se prepisuva , umnozuva niti kopira .bez soglasnost od Electroluks vo sproftivo se snosaf posledici vo smisla na clenovite 163 i 164 od kriticniot zakon R.M. (povreda na avtorsko pravo)

Adresa: ul.Braka Mingovi 18, 7000 Bitola; tel: 047/203-330 ,203 900ul.A.Guslarot.1a 02/329 8 130 Skopje

www.elektroluks.com. e-mail: elek-palenzo@mt.net.mk



Electrolux

INDUSTRIJA ZA EL. GREADNI I GUMENI PROIZVODI

Einzelbuchsen
Single bushes
Passes fils simples

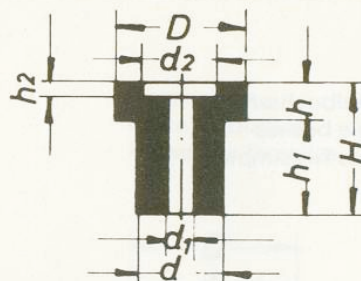

Art. Nr.	D ϕ	d ϕ	d ₁ ϕ	d ₂ ϕ	H	h	h ₁	h ₂
6266/51	10,3	7,6	4,2		12	6	6	
6327/12	11	6,55	2,1		10	2,5	7,5	
6266/30	11	7,8	5,7	6,4	7	4	3	2,3
6266/38	11	7,5	2,5		12	3	9	
6366/12	11	8	3		9	3	6	
6366/61	11	7,5	3,5		11	1,5	9,5	
6366/12 a	11,5	7,6	3		14	2,5	11,5	
6266/6	12,3	10	2x1,5		9	3	6	
6266/21	12,5	9,7	4,2		10,2	8	2,2	
6366/44	14	7,65	4,2		5	3,4	1,6	
6266/32	14,85	12,7	4,55		10	7	3	
6266/1	16	10	4		9,5	3	6,5	
6266/3	16	9	2,2		16	6	10	
6266/19	24,5	18	13		14	4	10	
6266/7	28	21	17		14,5	3,5	11	

Ovaj crtez e sopstvenost na Electrolux-Bitola.Bez negovo pismeno odobruvanje istiot nesmee da se prepisuva , umnozuva niti kopira .bez soglasnost od Elcitoluks vo sproftivno se snosat posledici vo smisla na clenovite 163 i 164 od kivicniot zakon R.M. (povreda na avtorsko pravo)

Adresa: ul.Braka Mingovi 18, 7000 Bitola; tel: 047/203-330 ,203 900ul.A.Guslarot.1a 02/329 8 130 Skopje

www.elektroluks.com. e-mail: elek-palenzo@mt.net.mk



Electrolux

**INDUSTRIJA ZA EL.GREAČE
I GUMENI PROIZVODI**

Ovaj crtež e sopstvenost na Electrolux-Bitola.Bez negovo pismeno odobravanjaje isitot nesmee da se prepisuva , umnozuva niti kopira , bez soglasnost od Eictrtoluks vo sprovatno se snosat posledici vo smisla na clenovite 163 i 164 od kriticniot zakon R.M. (povreda na avtorisko pravto)

Rillenbuchsen
Reel bushes
Passes fils à gorge

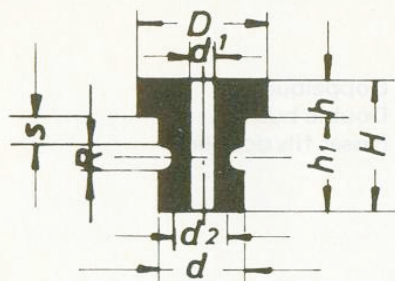

Art. Nr.	D Ø	d Ø	d1 Ø	d2 Ø	H	h	h1	S	R
6321/5 A	16	9,5	4,2	8	13	5	8	2,5	1,5
6321/11	18	12	4,5	10,5	15	4	11	2,9	1,5
6323/5	19	15	10	13	12	5	7	0,5	2
6323/5 A	19	15	10	13	12	5	7	2,5	2
6321/9	22	17,2	9,5x3,2	16,2	16,5	7,3	9,2	2,5	2
6221/8	25	18	13	16,5	12	4	8	1,5	1,5

Adresa: ul.Braka Mingovi 18, 7000 Bitola; tel: 047/203-330 ,203 900ul.A.Guslarot.1a 02/329 8 130 Skopje

www.elektroluks.com. e-mail: elek-palenzo@mt.net.mk



Electrolux

INDUSTRIJA ZA EL. GREAO
I GUMENI PROIZVODI

Ovoj crtez e sopstvenost na Electrolux-Bitola.Bez negovo pismeno odobruvanje istiot nesmee da se prepisuva , umnozuva niti kopira .bez soglasnost od Electroluks vo sproftivno se snosaf posledici vo smisla na clenovite 163 i 164 od kriticniot zakon R.M. (povreda na avtorsko pravo)

Doppelbuchsen
Double bushes
Passes fils doubles

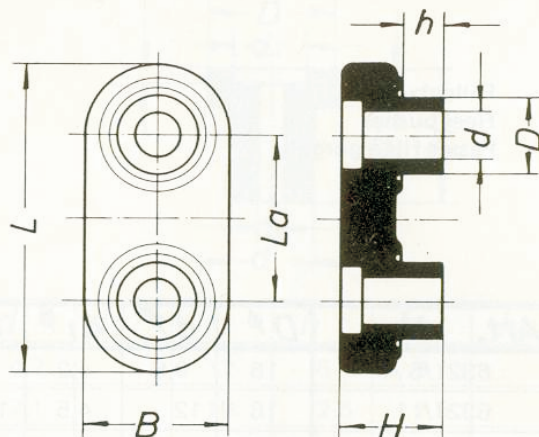

	Art. Nr.	L	B	H	h	D	d	La
	6220	34,5	16,5	11	4,5	8,5	5,2	19
	6220/1	34,5	16,5	11	4,5	9	5,2	19
	6320/2 A	35,6	17,4	11,8	5,8	8,75	4,5	19
	6220/3	34,5	16,5	10,3	3,2	9,4	6,1	19
	6320/5	35,6	17,4	11,8	5,8	8,75	4,5	19
	6220/6	35,6	17,4	11,8	5,8	8,75	4,5	19

Adresa: ul.Braka Mingovi 18, 7000 Bitola; tel: 047/203-330 ,203 900ul.A.Guslarot.1a 02/329 8 130 Skopje

www.elektroluks.com. e-mail: elek-palenzo@mt.net.mk



Electrolux

INDUSTRIJA ZA EL. GREJANJE
I GUMENI PROIZVODI

Ovaj crtez e sopstvenost na Electrolux-Bitola.Bez negovo pismeno odobruvanje istiot nesmee da se prepisuva , umnozuva niti kopira .bez soglasnost od Elcitoluks vo sproftivno se snoscat posledici vo smisla na clenovite 163 i 164 od kriticniot zakon R.M. (povreda na avtorsko pravo)

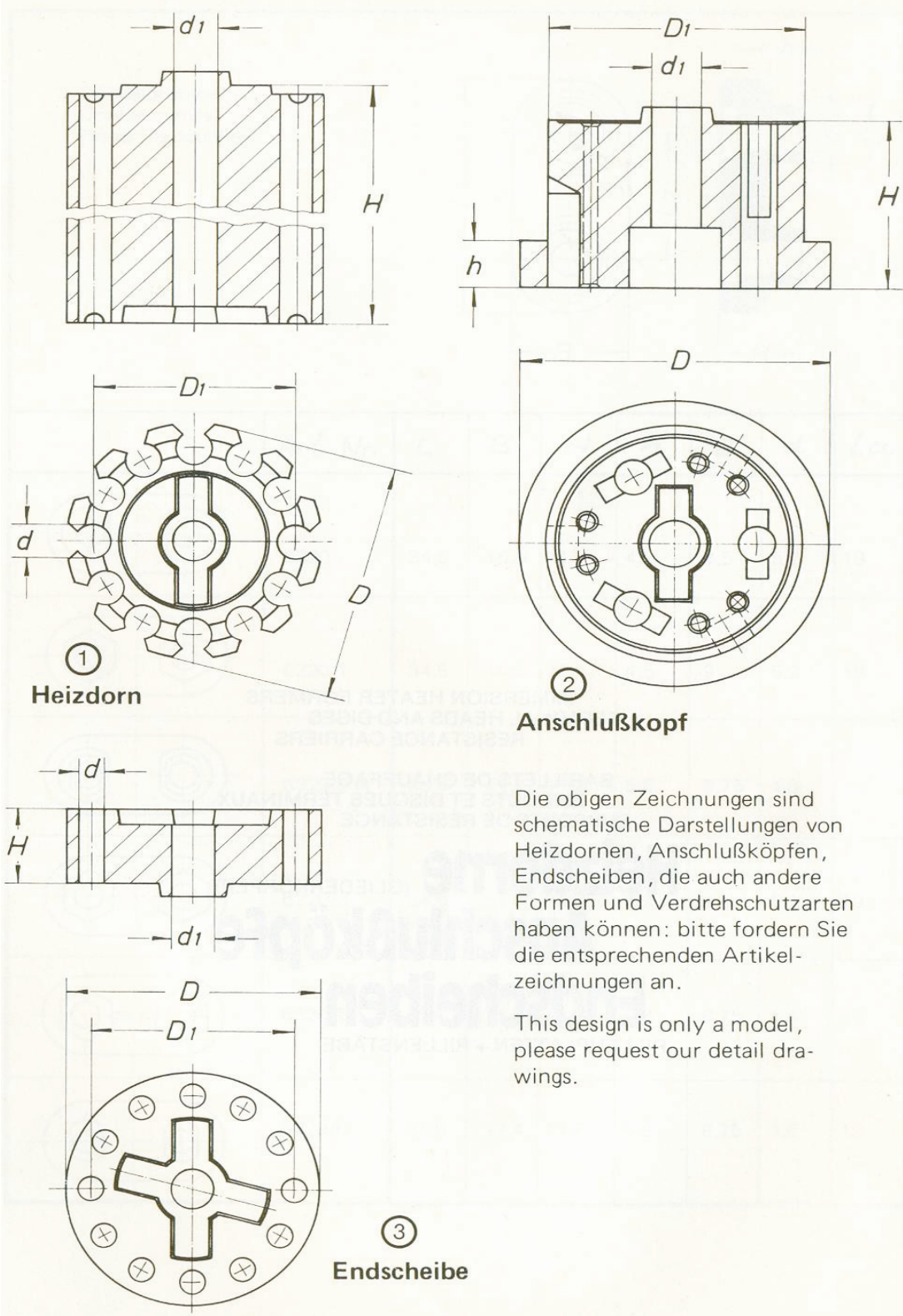

Die obigen Zeichnungen sind schematische Darstellungen von Heizdornen, Anschlußköpfen, Endscheiben, die auch andere Formen und Verdrehschutzarten haben können: bitte fordern Sie die entsprechenden Artikelzeichnungen an.

This design is only a model, please request our detail drawings.

Adresa: ul.Braka Mingovi 18, 7000 Bitola; tel: 047/203-330 ,203 900ul.A.Guslarot.1a 02/329 8 130 Skopje

www.elektroluks.com. e-mail: elek-palenzo@mt.net.mk



Electrolux

INDUSTRIJA ZA EL. GREJAO
I GUMENI PROIZVODI

Ovaj crtez e sopstvenost na Electrolux-Bitola.Bez negovo pismeno odobruvanje istiot nesmee da se prepisuva , umnozuva niti kopira .bez soglasnost od Elcitoluks vo sproftivno se snosaf posledici vo smisla na clenovite 163 i 164 od kivicniot zakon R.M. (povreda na avtorsko pravo)

Anschlußköpfe 2
Heizdorne 1
Endscheiben 3

Terminal Heads 2
Immersion heater formers 1
Terminal pieces 3

Embouts 2
Barillets de Chauffage 1
disques terminaux 3

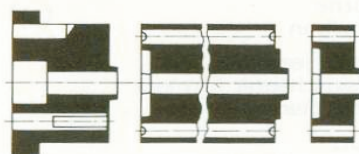

2	1	3	D	D ₁	d	d ₁	H	h		
6275/15			37,5	32		6	20	5		3
	6971/10 a		31	19	5,2	5,2	49		8	
		6644/14	32	22,5	2,5	5,5	15,5		8	
6275/15			37,5	32		6	20	5		3
	6671/9		32	21,5	6	6	50,5		8	
		6644/14	32	22,5	2,5	5,5	15,5		8	
6275/27			44	35,5		6	25	7		3
	6671/17		35,5	28,5	5,2	6,3	49,5		12	
		6644/21	35,5	28	2,5	6	11		12	
6975/25			49	38		6,3	40	20		4
	6671/14		38,5	29	5,2	6	50,5		12	
		6644/22	39	29	3,1	6	10		12	
6975/24			52	45		6,2	45	20		4
	6671/4E		44,5	35	6	7,5	48		12	
		6644/20	45,5	36	3,1	7	12,5		12	
6975/16			55	46		4	50	13		4
	6671/18		45	33	5,8	8	49		12	
		6644/9	45	35	4	6,8	10		12	
6975/24			52	45		6,2	45	20		4
	6671/15		46	35	6,45	8	50,5		12	
		6644/9	45	35	4	6,8	10		12	
7975/26			54	46		7,6	27	7		4
	6671/16		46	36	6,3	7,2	50		12	
		6644/20	45,5	36	3,1	7	12,5		12	
6975/16			55	46		4	50	13		4
	6671/18 b		46	33	6,2	8	49		12	
		6644/9	45	35	4	6,8	10		12	

Adresa: ul.Braka Mingovi 18, 7000 Bitola; tel: 047/203-330 ,203 900ul.A.Guslarot.1a 02/329 8 130 Skopje

www.elektroluks.com. e-mail: elek-palenzo@mt.net.mk



Electrolux

INDUSTRIJA ZA EL. GREAO
I GUMENI PROIZVODI

Ovoj crtez e sopstvenost na Electrolux-Bitola.Bez negovo pismeno odobruvanje istiot nesmee da se prepisiva , umnozuva niti kopira .bez soglasnost od Elcitoluks vo sproftivno se snosat posledici vo smisla na clenovite 163 i 164 od krivicniot zakon R.M. (povreda na avtorsko pravo)

Anschlußköpfe
Heizdorne
Endscheiben

Terminal Heads
Immersion heater formers
Terminal pieces

Embouts
Barillets de Chauffage
disques terminaux

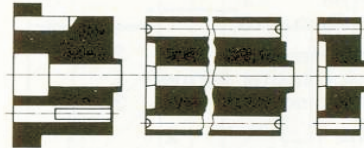

2	1	3	D	D ₁	d	d ₁	H	h		
6675/14a			58			7	15,5			6
	6671/4 a		47,5	37	6,5	7,5	50		12	
		6644/7	48	38,5	3	6,5	14		12	
6275/13b			58			7	15,5			6
	6671/4 c		46,55	37	6,5	7,5	50		12	
		6644/12	57	39	3,1	7	14,5		4	
6675/5			62	48		4,5	33	26		4
	6671/4 d		47,5	37	6,5	7,5	50		12	
		6244/5	47,5	29	7	7	15		4	
6275/14a			58			7	15,5			6
	6671/4aN		48	35,5	6,4	7,5	49		12	
		6644/12	57	39	3,1	7	14,5		4	
6675/7			67,8			6,5	50			
	6671/7		49	38,8	5,5	7	50		10	
		6644/2	67,25			7	21			
6975/6			61	57		6,2	30	8		3
	6971/6		57	44	7	7,2	50		12	
		6944/17	57	44	4	6,2	10		12	

Adresa: ul.Braka Mingovi 18, 7000 Bitola; tel: 047/203-330 ,203 900ul.A.Guslarot.1a 02/329 8 130 Skopje

www.elektroluks.com. e-mail: elek-palenzo@mt.net.mk



Electrolux

INDUSTRIJA ZA EL.GREAO
I GUMENI PROIZVODI

Ovaj cifrez e sopstvenost na Electrolux-Bitola.Bez negovo pismeno odobruvanje istiot nesmee da se prepisuva , umnozuva niti kopira .bez soglasnost od Elctroluks vo sproftivno se snosaf posledici vo smisla na clenovite 163 i 164 od kvicniot zakon R.M. (povreda na avtorsko pravo)

Anschlußköpfe
Heizdorne
Endscheiben
Terminal Heads
Immersion heater formers
Terminal pieces
Embouts
Barillets de Chauffage
disques terminaux

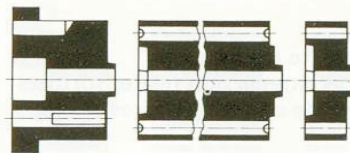

2	1	3	D	D_1	d	d_1	H	h		
	6671/12		35,25	23,25	6,15	6	43		8	
	6671/2		38,5	25	8	5,2	50,5		6	
	6971/20		47,05	37	6	7,7	55		12	
	6671/13 a		46	34,35	5,8	6,4	49		12	
	6671/1		98	80	13	54	42		12	

Adresa: ul.Braka Mingovi 18, 7000 Bitola; tel: 047/203-330 ,203 900ul.A.Guslarot.1a 02/329 8 130 Skopje

www.elektroluks.com. e-mail: elek-palenzo@mt.net.mk



Electrolux

INDUSTRIJA ZA EL. GREJAO
I GUMENI PROIZVODI

Extrudierte Heizdorne
Extruded immersion heater formers
Barillets de chauffage etires

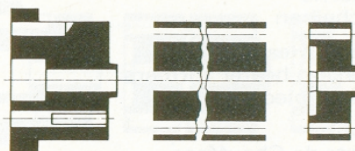

2	1	3	D	D ₁	d	d ₁	H	h		
6275/2N			26	17		2,4	18	9		4
	6670/2 b		16,8	11,5	4	3,5	80		6	
6275/2M			26	17		2,4	18	9		2
	6670/2		18	12	4	4,3	80		6	
		6243/3	18	12	2	2	5,5		4	
	6670/k		19,75	11	3,6	4,5	80		6	
		6340/1 a	19			2,3	5			
6215/E			21,7	19,7			21,35	10,75		
	6670/13		21	13,6	5,2	5,2	110		6	
		6340/bR	21			4,5	5			
	6670/5		21,5	14	3,5	6	60		8	
	6670/16		23,05	12,3	4,5	4,7	60		6	
	6670/11		25,5	16,5	5,7	4,5	50		6	
		6244/3	28,5	22	2,5	5	5		4	
	6670/3		28	19	5,5	8SW	80		8	
		6244/3	28,5	22	2,5	5	5		4	
	6670/1 b		35,5	25,5	5	□5	80		12	

Ovaj cifrez e sopstvenost na Electrolux-Bitola.Bez negovo pismeno odobravanje istiot nesmee da se prepisuva , umnozuva niti kopira .bez soglasnost od Electroluks vo sproftivno se snosaf posledici vo smisla na clenovite 163 i 164 od krivicniot zakon R.M. (povreda na avtorsko pravo)

Adresa: ul.Braka Mingovi 18, 7000 Bitola; tel: 047/203-330 ,203 900ul.A.Guslarot.1a 02/329 8 130 Skopje

www.elektroluks.com. e-mail: elek-palenzo@mt.net.mk



Electrolux

INDUSTRIJA ZA EL. GREJAO
I GUMENI PROIZVODI

Ovaj crtež e sopstvenost na Electrolux-Bitola.Bez negovo pismeno odobruvanje istiot nesmee da se prepisuva , umnozuva niti kopira .bez soglasnost od Elcitoluks vo sproftivno se snosaf posledici vo smisla na clenovite 163 i 164 od kriticniot zakon R.M. (povreda na avtorsko pravo)

Extrudierte Heizdorne
Extruded immersion heater formers
Barillets de chauffage etires

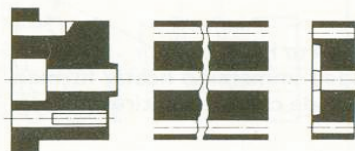

2	1	3	D	D ₁	d	d ₁	H	h		
6275/27			44	35,5		6	25	7		3
	6670/12		35,25	23,25	6,65	10	50		8	
		6644/21	35,5	28	2,5	6	11		12	
	6670/9		37	22,5	8	□7,5	80		6	
6975/1			49,5	38		4,5	42	17		3
	6670/1 d		37	27	5	□5	80		12	
		6644/1	38,5	28	5	6	17		12	
6975/1			49,5	38		4,5	42	17		3
	6670/1 c		37,5	26	5	□8	80		12	
		6644/1	38,5	28	5	6	17		12	
6975/1			49,5	38		4,5	42	17		3
	6673/2		37,5	29	5	18	80		12	
		6644/1	38,5	28	5	6	17		12	
6975/1a			46,5	37		4,5	41,5	15,5		3
	6670/1 a		38	28	5	□8	80		12	
		6644/1	38,5	28	5	6	17		12	
6975/1a			46,5	37		4,5	41,5	15,5		3
	6670/9 a		38	23,5	8,5	□7,5	80		6	
		6644/1	38,5	28	5	6	17		12	
6975/1			49,5	38		4,5	42	17		3
	6670/1		39	28,5	5	□8	80		12	
		6644/1	38,5	28	5	6	17		12	
6675/9			50	40		□7,5	37	16		6
	6670/6		41,5	28,5	7	□8	80		8	

Adresa: ul.Braka Mingovi 18, 7000 Bitola; tel: 047/203-330 ,203 900ul.A.Guslarot.1a 02/329 8 130 Skopje

www.elektroluks.com. e-mail: elek-palenzo@mt.net.mk



Electrolux

**INDUSTRIJA ZA EL. GREJAO
I GUMENI PROIZVODI**

Ovaj crtez e sopstvenost na Electrolux-Bitola.Bez negovo pismeno odobruvanje istiot nesmee da se prepisiva , umnozuva niti kopira .bez soglasnost od Electroluks vo sproftivno se snosaf posledici vo smisla na clenovite 163 i 164 od kivicniot zakon R.M. (povreda na avtorsko pravo)

Extrudierte Heizdorne
Extruded immersion heater formers
Barillets de chauffage etires

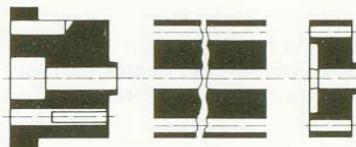

2		1		3		D	D _i	d	d _i	H	h		
6975/16						55	46		4	50	13		4
	6670/4					48	37	6	21	80		12	
		6244/5				47,5	29	7	7	15		4	
	6670/15					59	44	7	23	80		12	
	6970/10					77	62	12,2	40	100		10	

Adresa: ul.Braka Mingovi 18, 7000 Bitola; tel: 047/203-330 ,203 900ul.A.Guslarot.1a 02/329 8 130 Skopje

www.elektroluks.com. e-mail: elek-palenzo@mt.net.mk



Electrolux

INDUSTRIJA ZA EL. GREJAO
I GUMENI PROIZVODI

Rillenstäbe
Cores
Barres

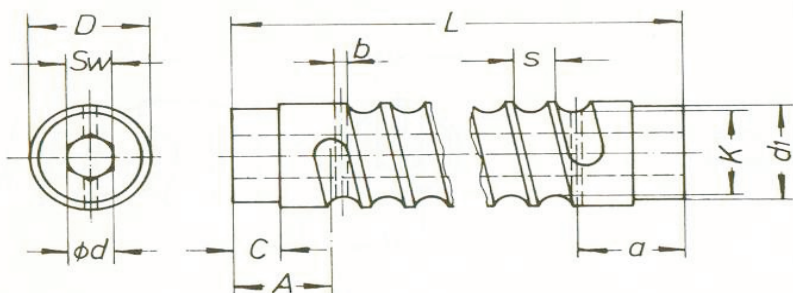

	D	L	d	A	K	S	a	b	d ₁	C	SW
6961/20 a L	12,85	200	—	16	11	4,7	20,7	2,5	—	—	5,7
6961/25 a	12,85	250	5,7	16	11	4,7	—	—	—	—	—
6961/63	12,85	280	—	16	11	4,7	—	—	—	—	5,7
6961/17	13	170	—	10	11	4,7	—	—	—	—	5,7
6961/20 a	13	200	—	10	11	4,7	—	—	—	—	5,7
6661/23 a	13	235	5	17	10	4,5	18	1,5	11,9	10	—
6661/23 b	13	250	—	16,5	10	4,5	—	—	—	—	□4,5
6661/25 e	13	250	5	17	10,6	4,5	—	—	—	—	—
6961/56	13	253	5	15	10,5	4,5	—	—	—	—	—
6661/E	13	340	5	18,5	10,5	4	—	—	—	—	—
6661/13	14	130	—	16	11,5	4,5	—	—	—	—	5,5
6661/15	14	150	—	16	11,5	4,5	—	—	—	—	5,5
6661/20	14	200	—	16	11,5	4,5	—	—	—	—	5,5
6661/24	14	240	—	16	11,5	4,5	—	—	—	—	5,5
6661/25	14	250	—	16	11,5	4,5	—	—	—	—	5,5
6661/26	14	260	—	16	11,5	4,5	—	—	—	—	5,5
6661/28	14	280	—	16	11,5	4,5	—	—	—	—	5,5
6661/29	14	290	—	16	11,5	4,5	—	—	—	—	5,5
6661/30	14	300	—	16	11,5	4,5	—	—	—	—	5,5
6661/V	15	232	6	—	14	0,95	7	3,5	—	—	—
6961/52	15	265	—	17,5	12,5	4,5	18	2	12	15	5,5
6661/25 b	16	250	5	17	13,6	4,5	—	—	13	12	—
6661/25 c	16	250	5	17	13,6	4,5	—	—	12,5	12,5	—
6661/25 d	16,4	250	5	17	14	4,5	—	—	14	12,5	—
6661/45 L	22	300	14	16	19,5	4,5	10	2	—	—	—
6961/55	22	300	12	16	19	5	10	2	—	—	—
6661/B	23	250	13	8	20	8	—	—	—	—	—
6961/61	25	280	12	16	22	3,33	10	2	—	—	—

Ovaj crtez e sopstvenost na Electrolux-Bitola.Bez negovo pismeno odobruvanje istiot nesmee da se prepisuva , umnozuva niti kopira . bez soglasnost od Electroluks vo sprofitno se snosaf posledici vo smisla na clenovite 163 i 164 od krivicniot zakon R.M. (povreda na avtorsko pravo)

Adresa: ul.Braka Mingovi 18, 7000 Bitola; tel: 047/203-330 ,203 900ul.A.Guslarot.1a 02/329 8 130 Skopje

www.elektroluks.com. e-mail: elek-palenzo@mt.net.mk



Electrolux

INDUSTRIJA ZA EL. GREAD
I GUMENI PROIZVODI

Rillenstäbe
Cores
Barres

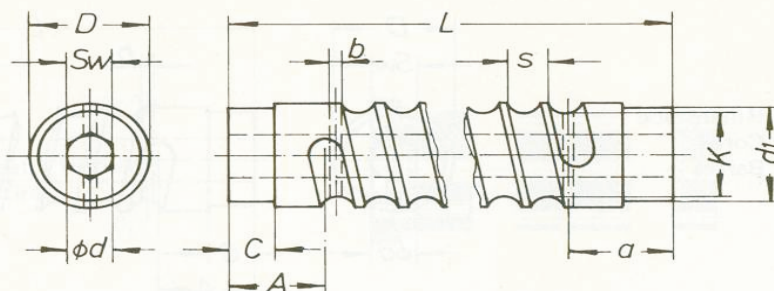

	D	L	d	A	K	S	a	b	d ₁	C	SW
6664/6	26	325	9	—	23	11	—	—	—	—	—
6664/20	27	200	15	16	23	6	—	—	—	—	—
6961/51	27	280	15	17	24	5	10	2	—	—	—
6961/54	28	275	15	16	25	6	10	2	—	—	—
6661/A	29,5	100	8□	—	23	12	—	—	—	—	—
6961/59	34	320	9	—	30	8	—	—	—	—	—
6664/1	35	128	15	18	30	9	—	—	—	—	—
6664	35	250	15	18	30	9	—	—	—	—	—
6961/53	35	280	15	16	32	10	10	2	—	—	—
6961/60	35	280	15	16	32	3,33	10	2	—	—	—
6964/2	36	370	22	—	33	6,5	—	—	—	—	—
6964/3	48	575	20	—	40	10	—	—	—	—	—

Ovoj cifrez e sopstvenost na Electrolux-Bitola.Bez negovo pismeno odobruvanje istiot nesmee da se prepisiva , umnozuva niti kopira .bez soglasnost od Electroluks vo sproftivo se snosat posledici vo smisla na clenovite 163 i 164 od krivicniot zakon R.M. (povreda na avtorsko pravo)

Adresa: ul.Braka Mingovi 18, 7000 Bitola; tel: 047/203-330 ,203 900ul.A.Guslarot.1a 02/329 8 130 Skopje
 www.elektroluks.com. e-mail: elek-palenzo@mt.net.mk



Electrolux

INDUSTRIJA ZA EL. GREJAO
I GUMENI PROIZVODI

Rillenstäbe
Cores
Barres

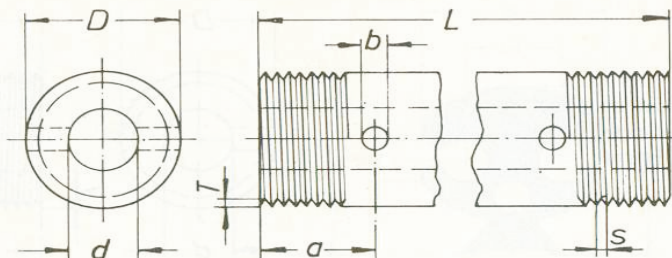

Art. Nr.	D	L	d	a	T	b	S
6663/12	10	120	5	0,5	0,95	3	1,5
6963/32 L	11	320	5,5	1,04	1,2	5	5
6663/1	12	250	5	1	1	15	2
6963/X	13	250	5	1,47	1,7	5	4,5
6963/Y	13	280	5	1,47	1,7	5	4,5
6663/16 L	14	160	5,5	0,69	0,8	10	1,8
6963/24 L	14	240	5,5	1,04	1,2	10	2
6663/28	14	280	5	1	1,2	10	2
6663/4	14,7	60	5,5	1	1,8	—	—
6663/2	25	75	16	0,8	0,9	—	—
6963/D	25	300	15	2,84	3,28	10	2
6963/S	30	130	15	0,87	1	10	2
6963/T	30	130	15	1,3	1,5	10	2
6963/18 L	30	150	15	2,2	2,54	10	2
6963/19 L	30	150	15	1,22	1,41	10	2
8263/P	30	250	15	1,47	1,7	10	2
6963/U	30	250	15	0,87	1	10	2
6963/V	30	250	15	1,3	1,5	10	2
6963/E	30	280	15	4,66	5,38	10	2
6963/M	35	135	21	1,65	1,9	10	2
6963/47	35	140	21	0,95	1,1	10	2
6963/48	40	200	21	0,95	1,1	10	2
6963/21 L	40	300	20	2,2	2,54	10	2
6963/F	40	300	21	2,84	3,28	10	2
6963/G	40	300	21	3,71	4,28	10	2
6963/H	40	300	21	4,66	5,38	10	2
6963/23 L	50	200	30	2,2	2,54	10	2
6963/K	50	200	30	2,84	3,28	10	2

Ovaj crtez e sopstvenost na Electrolux-Bitola.Bez negovo pismeno odobruvanje istiot nesmee da se prepisiva , umnozuva niti kopira .bez soglasnost od Electroluks vo sproftivo se snosaf posledici vo smisla na clenovite 163 i 164 od kriticniot zakon R.M. (povreda na avtorsko pravo)

Adresa: ul.Braka Mingovi 18, 7000 Bitola; tel: 047/203-330 ,203 900ul.A.Guslarot.1a 02/329 8 130 Skopje

www.elektroluks.com. e-mail: elek-palenzo@mt.net.mk



Electrolux

**INDUSTRIJA ZA EL.GREAO
I GUMENI PROIZVODI**

Ovoj crtez e sopstvenost na Electrolux-Bitola.Bez negovo pismeno odobruvanje istiot nesmee da se prepisuva , umnozuvata niti kopira .bez soglasnost od Electroluks vo sproftivno se snosat posledici vo smisla na clenovite 163 i 164 od krivicniot zakon R.M. (povreda na avtorsko pravo)

Rillenstäbe
Cores
Barres

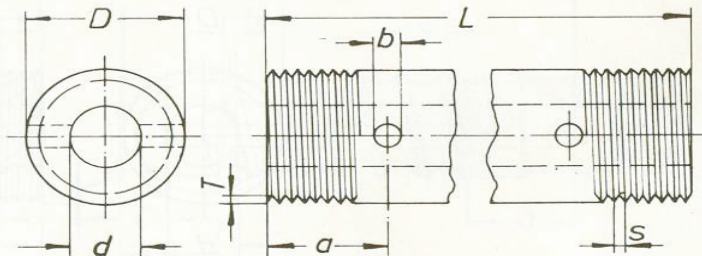

<i>Art. Nr.</i>	<i>D</i>	<i>L</i>	<i>d</i>	<i>a</i>	<i>T</i>	<i>b</i>	<i>S</i>
6963/J	50	300	30	3,71	4,28	10	2
6963/W	50	400	30	1,56	1,8	10	2
6963/L	55	300	30	3,71	4,28	10	2



Electrolux

INDUSTRIJA ZA EL. GREJAO
I GUMENI PROIZVODI

Ovaj crtez e sopstvenost na Electrolux-Bitola.Bez negovo pismeno odobruvanje istiot nesmee da se prepisuva , umnozuva niti kopira .bez soglasnost od Elcitoluks vo sproftivno se snosaf posledici vo smisla na clenovite 163 i 164 od krivicniot zakon R.M. (povreda na avtorsko pravo)

Heizleisten
Resistance carriers
Supports de resistance

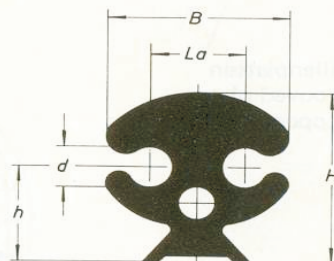

	Art.Nr	L	B	H	h	d	La
	6657/12	60	20,8	12,25	6	6	9
	6657/17	45	21	17,5	13	6,8	10
	6657/22	75	23	21	14	6	11
	6657/9 a	50	24,6	12,5	6,25	4	12,5
	6657/19	75	25	26	14,5	7,85	13
	6657/19 a	75	25	26	14,5	6,35	13
	6657/18	75	26	21,5	14	7,85	11

Adresa: ul.Braka Mingovi 18, 7000 Bitola; tel: 047/203-330 ,203 900ul.A.Guslarot.1a 02/329 8 130 Skopje

www.elektroluks.com. e-mail: elek-palenzo@mt.net.mk



Electrolux

INDUSTRIJA ZA EL.GREAO
I GUMENI PROIZVODI

Ovaj cifaz e sopstvenost na Electrolux-Bitola.Bez negovo pismeno odobruvanje istiot nesmee da se prepisuva , umnozuva niti kopira .bez soglasnost od Electroluks vo sproftivno se snocat posledici vo smisla na clenovite 163 i 164 od krivicniot zakon R.M. (povreda na avtorsko pravo)

Rillenplatten
Grooved plates
Supports de resistance

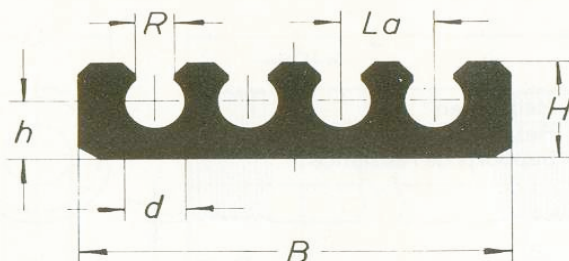

Art. Nr.	L	B	H	La	d	R	h
6656/4	100	39	13	9	5	2,5	6
6656/1	100	53	16	11	8	4,5	8,5
6656/8	120	84	16	11	8	4,5	8,5
6656/2	155	98	27	21	14	9,5	14
6656/2a	155	98	24	21	14	9,5	14,5

Adresa: ul.Braka Mingovi 18, 7000 Bitola; tel: 047/203-330 ,203 900ul.A.Guslarot.1a 02/329 8 130 Skopje

www.elektroluks.com. e-mail: elek-palenzo@mt.net.mk



Electrolux

INDUSTRIJA ZA EL. GREJANJE
I GUMENI PROIZVODI

Ovaj crtež e sopstvenost na Electrolux-Bitola.Bez negovo pismeno odobruvanje istiot nesmee da se prepisuva ,umnozuva niti kopira .bez soglasnost od Electroluks vo sproitivno se snosaf posledici vo smisla na clenovite 163 i 164 od krivicniot zakon R.M. (povreda na avtorsko pravo)

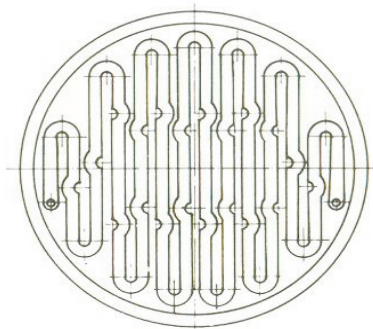

Kochplatteneinsätze
Cooking plates
Plateau-rechauds

für Ø	100 mm,	120 mm,	130 mm,	135 mm,
	140 mm,	150 mm,	160 mm,	180 mm,
	200 mm			

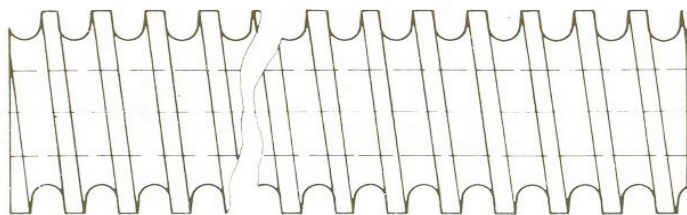

Rillenrohre für Nachtspeicheröfen auf Anfrage.
Cores for night storage heatings on request.
Barres pour chauffages a courant de nuit sur demande.

Adresa: ul.Braka Mingovi 18, 7000 Bitola; tel: 047/203-330 ,203 900ul.A.Guslarot.1a 02/329 8 130 Skopje

www.elektroluks.com. e-mail: elek-palenzo@mt.net.mk



Electrolux

INDUSTRIJA ZA EL. GREČI
I GUMENI PROIZVODI

Ovaj crtež e sopstvenost na Electrolux-Bitola.Bez negovo pismeno odobruvanje istiot nesmee da se prepisuva , umnozuva niti kopira .bez soglasnost od Elcitoluks vo sproftivno se snosaf posledici vo smisla na clenovite 163 i 164 od krivicniot zakon R.M. (povreda na avtorsko pravo)

Röhrchen
tubes
cañitos

Steatit
cordierit
stekor

Art. Nr. 8250
Art. Nr. 6650
Art. Nr. 6950

Andere Durchmesser und Längen auf Wunsch und Anfrage.

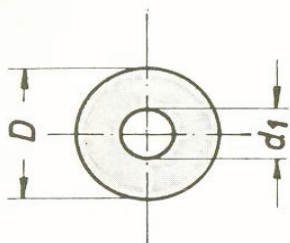

Art. Nr.	D	d	b	h	Tk	La	L
6650	4	2					50
	4	2,5					50
	4	2,8					50
	4,5	2,5					50
	5	2					50
	5	3					50
	6	2,5					50
	6	3					50
	6	3,5					50
	6	4					50
	6,5	4,5					50
	7	3,5					100
	7	4					600
	8	3					100
	8	4					100
	8	6					100
	9	5					100
	9,5	6,5					100
	10	5					100
	10	6					100
	12	6					100
	12	8					100
	13	5					100
	13	6					100
	13	10					100
	14	6					100
	14	7					100
	15	8					100
	17	8					100
	18	12					100

Adresa: ul.Braka Mingovi 18, 7000 Bitola; tel: 047/203-330 ,203 900ul.A.Guslarot.1a 02/329 8 130 Skopje

www.elektroluks.com. e-mail: elek-palenzo@mt.net.mk



Electrolux

INDUSTRIJA ZA EL. GREČNI
I GUMENI PROIZVODI

Ovaj crtež e sopstvenost na Electrolux-Bitola.Bez negovo pismeno odobruvanje istiot nesmee da se prepisuva , umnozuva niti kopira .bez soglasnost od Elcitoluks vo sproftivno se snocat posledici vo smisla na clenovite 163 i 164 od krivicniot zakon R.M. (povreda na avtorsko pravo)

Röhrchen
tubes
cañitos

Steatit
cordierit
stekor

Art. Nr. 8250
Art. Nr. 6650
Art. Nr. 6950

Andere Durchmesser und Längen auf Wunsch und Anfrage.

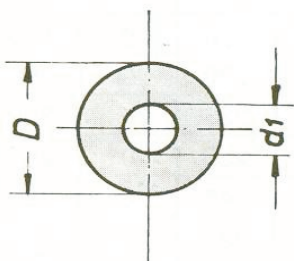

Art. Nr.	D	d1	b	h	Tk	La	L
6650	19	10					100
	20	6					100
	20	8					100
	20	10					100
	20	12					100
	22	10					100
	24	16					100
	25	10					100
	25	15					100
	26	15					100
	30	20					100
	35	25					100
	40	30					100
	50	40					100
65	50					100	
6450	7	5					50
	15	7					100
	20	10					100
	25	15					100
	30	20					100
6950	20	10					100
	25	10					100
	25	15					100
	30	20					100
8250	6	2,5					50
	7	5					50
	8	4					50

Adresa: ul.Braka Mingovi 18, 7000 Bitola; tel: 047/203-330 ,203 900ul.A.Guslarot.1a 02/329 8 130 Skopje

www.elektroluks.com. e-mail: elek-palenzo@mt.net.mk



Electrolux

INDUSTRIJA ZA EL. GREČI
I GUMENI PROIZVODI

Ovaj crtež e sopstvenost na Electrolux-Bitola.Bez negovo pismeno odobruvanje istiot nesmee da se prepisuva , umnozuva niti kopira .bez soglasnost od Electroluks vo sproftivno se snosaf posledici vo smisla na clenovite 163 i 164 od krivicniot zakon R.M. (povreda na avtorsko pravo)

Bundrohre
für
Industrieofenbau

cordierit 6655
stekor 6955

Art. Nr.	∅ D	∅ d	∅ d1	A	B	Lg
6455	22	11	6	120	20	140
6655/1	32	25	16	230	20	250
6655/2	22	14	7	235	15	250
6655/3	34	24	16	230	20	250
6955/4	32	24	16	240	20	260
6955/5	31	20	14	234	16	250
6455/6	25	18	8	250	15	265
6455/7	56	46	36	200	25	225
6455/9	70	50	40	510	20	530
6955/10	32	25	15	470	20	490
6955/11	32	20	10	200	20	220
6455/12	60	50	32	70	10	80
6655/13	35	29	21	64	6	70
6655/14	20	14	7	75	5	80
6955/15	32	24	14	330	20	350
6955/16	32	24	14	430	20	450
6455/17	31	25	15	505	30	535
6655/18	50	30	15	350	50	400
6655/19	22	15	8	180	15	195
6955/20	33	24	14	520	20	540
6655/21	25	20	10	70	15	85
6655/22	32	24	16	324	21	345
6655/23	22	14	8	30	15	45

Andere Durchmesser und Längen auf Wunsch und Anfrage.

Also other diameters and lengths can be delivered if requested.

Nous pouvons livrer aussi des autres diamètres et longueurs sur demande.

Adresa: ul.Braka Mingovi 18, 7000 Bitola; tel: 047/203-330 ,203 900ul.A.Guslarot.1a 02/329 8 130 Skopje

www.elektroluks.com. e-mail: elek-palenzo@mt.net.mk



Electrolux

INDUSTRIJA ZA EL. GREAO
I GUMENI PROIZVODI

Ovaj crtez e sopstvenost na Electrolux-Bitola.Bez negovo pismeno odobruvanje istiot nesmee da se prepisuva , umnozuva niti kopira .bez soglasnost od Elcitriluks vo sproftivno se snosaf posledici vo smisla na clenovite 163 i 164 od krivicniot zakon R.M. (povreda na avtorsko pravo)

Profiltröhre
profile tubes
tubes à profils
cañitos de
diversas formas

Steatit Art. Nr. 8251
steatit Art. Nr. 6251
cordierit Art. Nr. 6651
stekor Art. Nr. 6951

Andere Längen auf Wunsch und Anfrage.

	Art. Nr.	D	d1	b	h	Tk	La	L
	6651/4		4	7	7			50
	6651/4/1		5	8	8			50
	6651/4/2		6	10	10			50
	6453/14	28	9					40
	6651/3	13	3					50
	6654/6		6		15			50
	6451/8	4,5	1	7	4			15
	6651/F	7,4	2	12,1	5,5			50

Adresa: ul.Braka Mingovi 18, 7000 Bitola; tel: 047/203-330 ,203 900ul.A.Guslarot.1a 02/329 8 130 Skopje

www.elektroluks.com. e-mail: elek-palenzo@mt.net.mk



Electrolux

INDUSTRIJA ZA EL. GREAO
I GUMENI PROIZVODI

Ovaj crtež e sopstvenost na Electrolux-Bitola.Bez negovo pismeno odobruvanje istiot nesmee da se prepisuva , umnozuva niti kopira , bez soglasnost od Electroluks vo sproftivno se snosaf posledici vo smisla na clenovite 163 i 164 od krivicniot zakon R.M. (povreda na avtorsko pravo)

Zweilochrohre
two hole tubes
tubes a deux canaux
cañitos de dos agujeros

Steatit Art. Nr. 8252
steatit Art. Nr. 6252
cordierit Art. Nr. 6652
stekor Art. Nr. 6952

	Art. Nr.	D	d1	b	h	Tk	La	L
	6452/15a	6	1,8				2,6	50
	6652/2	10,7	1,3				4	30
	6652/10	8	1,5				4,5	39
	6652/15	8	2,6				3,6	50
	8252/23	12,2	3,5				5,5	100
	8252/3b		2,9	12,1	6,2		5,5	100
	6252/9		2,2	14,3	6		7,5	20
	6452/1		3,95	11,7	6,6		5,1	100
	6652		7	20	11,5		8,5	250
	6652/3		3,5	14,3	7,3		6,5	250
	6652/21		3	12	7		4,8	50
	6652/11	5	2,2	18	10		9	50

Andere Längen auf Wunsch und Anfrage.

Also other lengths can be delivered if requested.

Sur demande nous pouvons livrer aussi des autres longueurs.

Adresa: ul.Braka Mingovi 18, 7000 Bitola; tel: 047/203-330 ,203 900ul.A.Guslarot.1a 02/329 8 130 Skopje

www.elektroluks.com. e-mail: elek-palenzo@mt.net.mk



Electrolux

INDUSTRIJA ZA EL. GREAO
I GUMENI PROIZVODI

Ovaj crtez e sopstvenost na Electrolux-Bitola.Bez negovo pismeno odobruvanje istiot nesmee da se prepisuva , umnozuva niti kopira .bez soglasnost od Elcitoluks vo sproftivno se snosaf posledici vo smisla na clenovite 163 i 164 od kriticniot zakon R.M. (povreda na avtorsko pravo)

Dreilochrohre three hole tubes tubes a trois canaux cañitos de tres agujeros		Steatit	Art. Nr. 8253					
		steatit	Art. Nr. 6253					
		cordierit	Art. Nr. 6653					
		stekor	Art. Nr. 6953					
	Art. Nr.	D	d1	b	h	Tk	La	L
	6453/22	18,5	2			8,1		50
	8253/4a		1,9	12,1	4,6		7,5	100
	6253/7		2	14,3	5,3		9,5	7
	6653/10		2,2	1,8	9		9	70
	6253/3		2,3	14,3	7,3		8,4	7
	6653/13		2,3	14,2	7,1		8,4	50
	6653/19		3	16	7		9,5	50
	6653/9		3	20	7		13	75
	6953/3		4,3	14,5	13,4	8,6		302
	6953/3c		5,4	16,4	15,3	9,2		265

Auch Verbindungsnuten können auf Wunsch eingeschliffen werden.

Andere Längen auf Wunsch und Anfrage.

Also other lengths and diameters can be delivered if requested.

Nous pouvons livrer aussi des autres diamètres et longueurs sur demande.

Adresa: ul.Braka Mingovi 18, 7000 Bitola; tel: 047/203-330 ,203 900ul.A.Guslarot.1a 02/329 8 130 Skopje

www.elektroluks.com. e-mail: elek-palenzo@mt.net.mk



Electrolux

INDUSTRIJA ZA EL. GREAO
I GUMENI PROIZVODI

Ovaj crtez e sopstvenost na Electrolux-Bitola.Bez negovo pismeno odobruvanje istiot nesmee da se prepisuva , umnozuva niti kopira .bez soglasnost od Electroluks vo sproftvno se snosaf posledici vo smisla na clenovite 163 i 164 od krivicniot zakon R.M. (povreda na avtorsko pravo)

Vierlochrohr
four hole tubes
tubes a quatre canaux
canitos de cuatro agujeros

cordierit Art. Nr. 6651
stekor Art. Nr. 6951

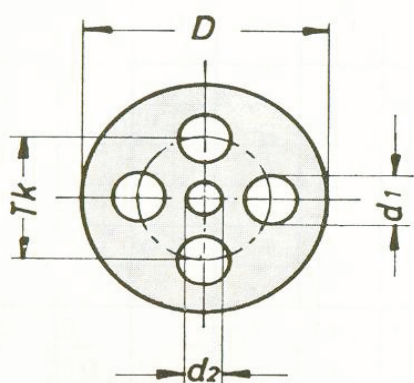

Art. Nr.	D	d1	d2	Tk	L
6651/M	9,5	2,5		5,5	100
6651/Q	16	3,5		9	50
6651/14	14	3,5		7	100
6651/16	17	4	2	8,5	100
6951/18	8,9	2		4,7	50
6951/22	11,7	3,3		9	100

Andere Längen auf Wunsch und Anfrage.

Stirnseitige Versenke auf beiden Seiten möglich.

Die Versenkwand kann auch auf Wunsch geschlitzt werden.

Also other lengths can be delivered on request.

Chamfers on both sides are possible.

A slot in the chamfer-wall can be made if desired.

Sur demande nous pouvons livrer aussi des autres longueurs.

Enfoncements à tous les deux bouts de tube possibles.

Sur demande nous livrons le mur d'enfoncement aussi avec une fente.

Adresa: ul.Braka Mingovi 18, 7000 Bitola; tel: 047/203-330 ,203 900ul.A.Guslarot.1a 02/329 8 130 Skopje

www.elektroluks.com. e-mail: elek-palenzo@mt.net.mk



Electrolux

INDUSTRIJA ZA EL. GREAD
I GUMENI PROIZVODI

Ovaj crtez e sopstvenost na Electrolux-Bitola.Bez negovo pismeno odobruvanje istiot nesmee da se prepisiva ,umnozuva niti kopira .bez soglasnost od Electroluks vo sproftivno se snosaf posledici vo smisla na clenovite 163 i 164 od krivicniot zakon R.M. (povreda na avtorsko pravo)

Sechslochrohr
six hole tubes
tubes a six canaux
cañitos de seis agujeros

cordierit Art. Nr. 6651
stekor Art. Nr. 6951

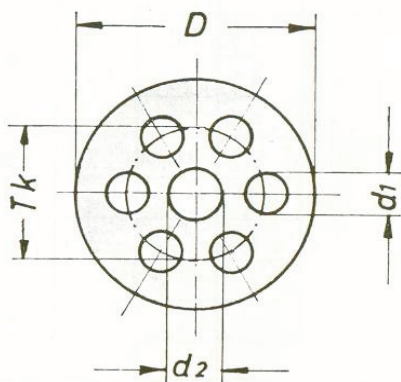

Art. Nr.	D	d1	d2	Tk	L
6651/g1	13,5	2,5	3,2	8,3	50
6651/J	15	3	3	9	100
6651/L	16,3	3,5	3,5	11	50
6651/N	19,5	5	5	12,5	50
6651/R	22,5	5	5	14	140
6651/S	16	3	4	10	100
6651/T	11,2	2	2	6,7	92,5
6651/W	36	5	7,3	24	155
6651/12	16,5	41	4	10,4	70
6651/13	15	2,5	4,5	9,6	100
6951/g	14,3	3	3	8,5	86
6951/Y	10	2,3	2,7	6,2	100
6951/1	9	1,7	3	6	100
6951/10	13	2	5	9	80
6951/17	15	3	3	8,3	94,5
6951/21	13	3	3	7,5	80
6951/23	15	3,3	3,3	8,7	106

Andere Längen auf Wunsch und Anfrage.

Stirnseitige Versenke auf beiden Seiten möglich.

Die Versenkwall kann auch auf Wunsch geschlitzt werden.

Other lengths can be delivered on request.

Chamfers on both sides of the tube are possible.

A slot in the chamfer-wall can be made if desired.

Sur demande nous pouvons livrer aussi des autres longueurs.

Enfoncement à tous les deux bouts du tube possibles.

Sur demande nous livrons le mur d'enfoncement aussi avec une fente.

Adresa: ul.Braka Mingovi 18, 7000 Bitola; tel: 047/203-330 ,203 900ul.A.Guslarot.1a 02/329 8 130 Skopje

www.elektroluks.com. e-mail: elek-palenzo@mt.net.mk



Electrolux

INDUSTRIJA ZA EL. GREAO
I GUMENI PROIZVODI

Ovaj crtež e sopstvenost na Electrolux-Bitola.Bez negovo pismeno odobruvanje istiot nesmee da se prepisuva , umnozuva niti kopira . bez soglasnost od Electroluks vo sproftvno se snosca posledici vo smisla na clenovite 163 i 164 od krivicniot zakon R.M. (povreda na avtorsko pravo)

Achtlochrohr
eight hole tubes
tubes a huit canaux
cañitos de ocho agujeros

cordierit Art. Nr. 6651
stekor Art. Nr. 6951

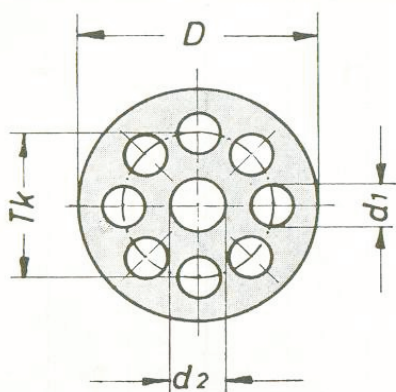

Art. Nr.	D	d1	d2	Tk	L
6651/b	20	3,5	8	14	80
6651/P	24	4,5	5	16	400
6651/P1	22,8	4,5	5	16	400
6951/0	40	7,2	16,5	27,7	300
6951/6	13	2	5	9	100
6951/19	10,4	1,4	4,9	7,65	59,5

Andere Längen auf Wunsch und Anfrage.

Stirnseitige Versenke auf beiden Seiten möglich.

Die Versenkwanu kann auch auf Wunsch geschlitz werden.

Other lengths can be delivered on request.

Chamfers on both sides of the tube are possible.

A slot in the chamfer-wall can be made if desired.

Sur demande nous pouvons livrer aussi des autres longueurs.

Enfoncement à tous les deux bouts du tube possibles.

Sur demande nous livrons le mur d'enfoncement aussi avec une fente.

Adresa: ul.Braka Mingovi 18, 7000 Bitola; tel: 047/203-330 ,203 900ul.A.Guslarot.1a 02/329 8 130 Skopje

www.elektroluks.com. e-mail: elek-palenzo@mt.net.mk



Electrolux

INDUSTRIJA ZA EL. GREAD
I GUMENI PROIZVODI

Ovaj crtež e sopstvenost na Electrolux-Bitola.Bez negovo pismeno odobruvanje istiot nesmee da se prepisuva , umnozuva niti kopira .bez soglasnost od Electroluks vo sproftivno se snosca posledici vo smisla na clenovite 163 i 164 od krivicniot zakon R.M. (povreda na avtorsko pravo)

Zehnlochrohr
ten hole tubes
tubes a dix canaux
cañitos de diez agujeros

stekor Art. Nr. 6951

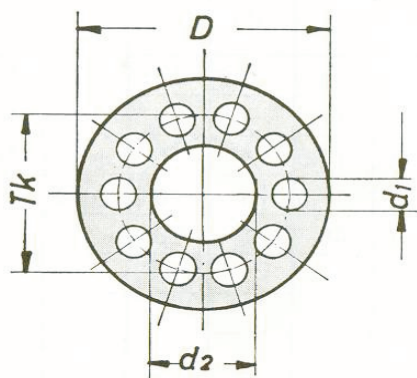

Art. Nr.	D	d1	d2	Tk	L
6951/15	17	2	7	11,5	140
6951/15a	17	2,3	7	11,5	55

Andere Längen auf Wunsch und Anfrage.

Stirnseitige Versenke auf beiden Rohrenden möglich.

Die Versenkwand kann auch auf Wunsch geschlitzt werden.

Other lengths can be delivered on request.

Chamfers on both sides of the tube are possible.

A slot in the chamfer-wall can be made if desired.

Sur demande nous pouvons livrer aussi des autres longueurs.

Enfoncements à tous les deux bouts du tube possibles.

Sur demande nous livrons le mur d'enfoncement aussi avec une fente.

Adresa: ul.Braka Mingovi 18, 7000 Bitola; tel: 047/203-330 ,203 900ul.A.Guslarot.1a 02/329 8 130 Skopje

www.elektroluks.com. e-mail: elek-palenzo@mt.net.mk



Electrolux

INDUSTRIJA ZA EL. GREAO
I GUMENI PROIZVODI

Ovaj crtež e sopstvenost na Electrolux-Bitola. Bez negovo pismeno odobruvanje istiot nesmee da se prepisiva , umnozuva niti kopira .bez soglasnost od Electroluks vo sproftivno se snosaf posledici vo smisla na clenovite 163 i 164 od krivicniot zakon R.M. (povreda na avtorsko pravo)

Sechzehnlochrohr
sixteen hole tubes
tubes a seize canaux
cañitos de diezseis agujeros

cordierit Art. Nr. 6651
stekor Art. Nr. 6951

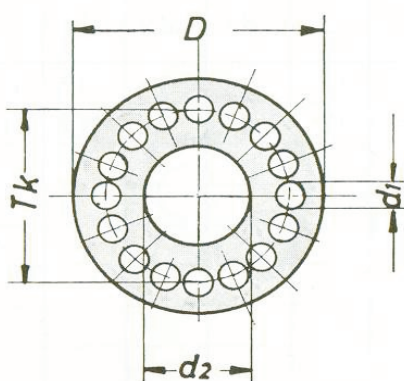

Art. Nr.	D	d1	d2	Tk	L
6651/c	23	2,2	14	19	100
6651/d	17	1,5	9,5	12,5	100
6651/e	11,5	1	6	9,5	100
6651/eI	11,5	1	6,5	9,5	55
6951/7	46	5	26	34,5	50

Andere Längen auf Wunsch und Anfrage.

Stirnseitige Versenke auf beiden Rohrenden möglich.

Die Versenkwand kann auch auf Wunsch geschlitzt werden.

Other lengths can be delivered on request.

Chamfers on both sides of the tube are possible.

A slot in the chamfer-wall can be made if desired.

Sur demande nous pouvons livrer aussi des autres longueurs.

Enfoncements à tous les deux bouts du tube possibles.

Sur demande nous livrons le mur d'enfoncement aussi avec une fente.

Adresa: ul.Braka Mingovi 18, 7000 Bitola; tel: 047/203-330 ,203 900ul.A.Guslarot.1a 02/329 8 130 Skopje

www.elektroluks.com. e-mail: elek-palenzo@mt.net.mk



Electrolux

INDUSTRIJA ZA EL. GREAO
I GUMENI PROIZVODI

Ovaj crtež e sopstvenost na Electrolux-Bitola.Bez negovo pismeno odobruvanje istiot nesmee da se prepisuva , umnozuva niti kopira .bez soglasnost od Electroluks vo sproftivno se snosca posledici vo smisla na clenovite 163 i 164 od kriticniot zakon R.M. (povreda na avtorsko pravo)

Zwanziglochrohr
twenty hole tubes
tubes a vingt canaux
cañitos de veinte agujeros

stekor Art. Nr. 6951

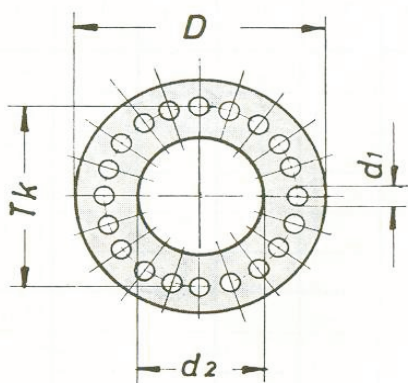

Art. Nr.	D	d1	d2	Tk	L
6951/V	22	2	6	17	100

Andere Längen auf Wunsch und Anfrage.

Stirnseitige Versenke auf beiden Rohrenden möglich.

Die Versenkwall kann auch auf Wunsch geschlitzt werden.

Other lengths can be delivered on request.

Chamfers on both sides of the tube are possible.

A slot in the chamfer-wall can be made if desired.

Sur demande nous pouvons livrer aussi des autres longueurs.

Enfoncements à tous les deux bouts du tube possibles.

Sur demande nous livrons le mur d'enfoncement aussi avec une fente.

Adresa: ul.Braka Mingovi 18, 7000 Bitola; tel: 047/203-330 ,203 900ul.A.Guslarot.1a 02/329 8 130 Skopje

www.elektroluks.com. e-mail: elek-palenzo@mt.net.mk



Electrolux

INDUSTRIJA ZA EL. GREJANJE
I GUMENI PROIZVODI

Ovaj crtež e sopstvenost na Electrolux-Bitola.Bez negovo pismeno odobruvanje istiot nesmee da se prepisuva , umnozuva niti kopira .bez soglasnost od Elcitoluks vo sproftvno se snosaf posledici vo smisla na clenovite 163 i 164 od krivicniot zakon R.M. (povreda na avtorsko pravo)

Brechröhrchen
crushable tubes
tubes écrasables
cañitos rompibles

Steatit Typ 221 verglüt
DIN 40685 KER 240
Zur Herstellung von Rohrheizkörper

Andere Längen auf Wunsch und Anfrage.

	Art. Nr.	D	d1	b	h	Tk	La	L
	7550	2,9	1,6					50
		3	1,7					50
		4,5	1,5					52
		5	3					100
		6,5	4,5					100
		6,5	2,5					100
		8	4					100
		8,3	3,5					100
		10	4					100
		7552/3aM		3,5	14,3	7,1		
7552/3aL			4,2	14,3	7,1			50
	7553/15	7,5	3					30
	7554/2	13,5	8					50

Adresa: ul.Braka Mingovi 18, 7000 Bitola; tel: 047/203-330 ,203 900ul.A.Guslarot.1a 02/329 8 130 Skopje

www.elektroluks.com. e-mail: elek-palenzo@mt.net.mk



Electrolux

INDUSTRIJA ZA EL. GREJANJE
I GUMENI PROIZVODI

Ovaj crtez e sopstvenost na Electrolux-Bitola.Bez negovo pismeno odobruvanje istiot nesmee da se prepisuva ,umnozuva niti kopira ,bez soglasnost od Elcitroluks vo sproftivno se snosaf posledici vo smisla na clenovite 163 i 164 od kriticniot zakon R.M. (povreda na avtorsko pravo)

Brechröhrchen
crushable tubes
tubes écrasables
cañitos rompibles

Steatit Typ 221 verglüt
DIN 40685 KER 240
Zur Herstellung von Rohrheizkörper

Andere Längen auf Wunsch und Anfrage.

	Art. Nr.	D	d1	b	h	Tk	La	L
	7552/14	9,5	2,1				4	100
	7552/19	12	2,6				4,7	100
	7552/25	8,5	2				3,5	100
	7552/29	16	3,5				6,5	100
	7552/16		2,1	7,8	4,8		3	75
	7552/3a		3,5	14,3	7,1		6,5	50
	7552/3aV		3,5	14,3	7,1		6,5	110
	7552/22		2,1	9	6,3		3,6	50

Adresa: ul.Braka Mingovi 18, 7000 Bitola; tel: 047/203-330 ,203 900ul.A.Guslarot.1a 02/329 8 130 Skopje

www.elektroluks.com. e-mail: elek-palenzo@mt.net.mk



Electrolux

INDUSTRIJA ZA EL. GREJANJE
I GUMENI PROIZVODI

Ovaj crtež e sopstvenost na Electrolux-Bitola.Bez negovo pismeno odobruvanje istiot nesmee da se prepisuva , umnozuva niti kopira .bez soglasnost od Electroluks vo sproftivno se snosaf posledici vo smisla na clenovite 163 i 164 od krivicniot zakon R.M. (povreda na avtorsko pravo)

Brechröhrchen
crushable tubes
tubes écrasables
cañitos rompibles

Steatit Typ 221 verglüt
DIN 40685 KER 240
Zur Herstellung von Rohrheizkörper

Andere Längen auf Wunsch und Anfrage.

	Art. Nr.	D	d1	b	h	T _k	La	L
		7552/5	12,8	3			6	
	7553/8	10,8	1,65	3	3	5		19
	7553/8a	10,8	1,65	3	3	5		38
	7553/8b	10,8	1,65	3	3	5		43
	7553/4		2,2	14,3	5,3		8,8	100
	7553/13		2,3	14,2	7,1		8,4	50
	7553/20		2,1	12,6	6,3		7,2	50

Adresa: ul.Braka Mingovi 18, 7000 Bitola; tel: 047/203-330 ,203 900ul.A.Guslarot.1a 02/329 8 130 Skopje

www.elektroluks.com. e-mail: elek-palenzo@mt.net.mk



Electrolux

INDUSTRIJA ZA EL. GREJAO
I GUMENI PROIZVODI

Ovaj crtež e sopstvenost na Electrolux-Bitola.Bez negovo pismeno odobruvanje istiot nesmee da se prepisuva , umnozuva niti kopira .bez soglasnost od Electroluks vo sproftivno se snosaf posledici vo smisla na clenovite 163 i 164 od krivicniot zakon R.M. (povreda na avtorsko pravo)

Brechröhrchen
crushable tubes
tubes écrasables
cañitos rompibles

Magnesiumoxyd

Andere Längen auf Wunsch und Anfrage

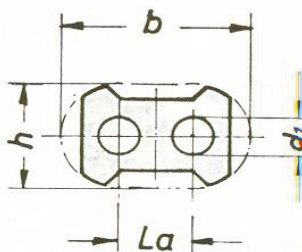
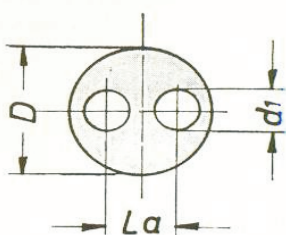

Art. Nr.	D	d1	b	h	Tk	La	L
7252/19	12	2,6				4,7	100
7252/25	8,8	2				3,5	100
7252/26	4	0,8				1,9	50
7252/27	5	1				2,2	50
7252/28	6,5	1,4				2,8	100
7252/29	16	3,5				6,5	100
7252/20		2,5	14,2	7,1		6,5	50

Außerdem liefern wir Einbettmassen zur Erzeugung von Kochplatten und Bügeleisensohlen.

We also deliver embedding compounds for cooking plates and stiring irons.

Nous livrons aussi des masses isolantes pour plaques électriques pour cuisinières et sols pour fer à repasser.

Adresa: ul.Braka Mingovi 18, 7000 Bitola; tel: 047/203-330 ,203 900ul.A.Guslarot.1a 02/329 8 130 Skopje

www.elektroluks.com. e-mail: elek-palenzo@mt.net.mk



Electrolux

INDUSTRIJA ZA EL. GREJANJE
I GUMENI PROIZVODI

Außerdem erzeugen wir folgende **keramische Isolierteile:**

Wendelteller, Heizleisten und Reiter, Rohre mit Anschluß- und Endstücken, Funkenkammern C 511.

Isolierbuchsen und Gegenbuchsen, Rillenbuchsen, Heizstabendperlen C 220 und C 221.

Weichisolierröhrchen verglüt C 221 und Endbuchsen (glasiert), Rillenheizstäbe C 511 und C 520, Heizkreuze C 511 und C 520.

Isolierperlen C 221, Stifte und andere Reglerbauteile aus Steatit (Gehäuse) C 221, NH-Patronen und Grundplatten C 221 und verschiedene andere Isolierteile aus Steatit C 220 und C 221 und keramische Sondermassen, Al_2O_3 etc.

Besides we are manufacturing:

Immersion heater formers, terminal heads and terminal discs, helical immersion heater formers, elements and grill formers, tubes, spark arresters C 511.

Crushable tubes of steatite and magnesium oxide, and bushes (glazed), rod element formers C 511 and C 520, hair driers C 511 and C 520.

Insulating beads C 221, pins and other thermostatic elements of steatite (casings) C 221, low voltage insulators and sockets C 221 and several other insulating items of steatite C 220 and C 221 and special ceramic materials, Al_2O_3 etc.

En outre nous produisons:

Barillets de chauffage, têtes terminaux et disques terminaux, supports hélicoïdaux à empilage, supports de resistance, tubes, chambres, d'éclateur C 511.

Tubes écrasables en stéatite et magnesium oxyde, embouts (glacé) supports pour sèche-cheveux et croisillons C 511 et C 520.

Perles isolantes C 221, composants thermostatiques en stéatite C 221, basse voltage isolateurs et socles C 221 et d'autres pièces isolantes en stéatite C 220 et C 221 et en masses céramique specials Al_2O_3 .

Ovaj crtez e sopstvenosti na Electrolux-Bitola.Bez negovo pismeno odobruvanje istiot nesmee da se prepisuva , umnozuva niti kopira .bez soglasnost od Elctroluks vo sproitivno se snosat posledici vo smisla na clenovite 163 i 164 od krivicniot zakon R.M. (povreda na avtorsko pravo)

Adresa: ul.Braka Mingovi 18, 7000 Bitola; tel: 047/203-330 ,203 900ul.A.Guslarot.1a 02/329 8 130 Skopje

www.elektroluks.com. e-mail: elek-palenzo@mt.net.mk



Electrolux

INDUSTRIJA ZA EL. GREČI
I GUMENI PROIZVODI



EIGENSCHAFTEN UND ANDWENDUNGSBEISPIELE UNSERER WERKSTOFFE
CHARACTERISTICS AND APPLICATIONS OF OUR MATERIALS

STEATIT Typ 220, STEKALIT Typ 221 — Dicht gesintert, mit feinkristallinem Gefüge aus magnesiumsilikathältigen Rohstoffen. Die mechanische Festigkeit ist sehr hoch. Diese Werkstoffe sind säure- und laugenbeständig und zeichnen sich durch hohe Durchschlagsfestigkeit aus.

STEKAL Typ 610 — Mit steigendem Gehalt an Aluminiumoxid steigt die Feuerfestigkeit und im gleichen Maße die mechanische Festigkeit wie die Wärmeleitfähigkeit.

STEATIT type 220, STEKALIT type 221 — Fully vitrified with fluxed soapstone. Very high mechanical strength. These materials are acid-resistant and alkali-proof and are characterized by high dielectric strength.

STEKAL type 610 — An increasing amount of alumina raises both the heat resistance and, to an equal extent, also the mechanical strength and the technical coefficient.

STEKATHERM Typ 511 — Poröser Werkstoff auf der Ton-Schamottebasis mit Specksteinzusätzen. Geringe Wärmeausdehnung. Hohe Temperaturwechselbeständigkeit bis 900° C.

STEKOR Typ 520 — Feinporöser Werkstoff mit hohem Al_2O_3 -Gehalt. Er besitzt eine Temperaturwechselbeständigkeit bis 1100° C und seine Durchschlagsfestigkeit, auch bei höheren Temperaturen, ist beachtlich.

STEKORIT Typ 410 — Hauptanteil ist das Cordierit. Besonders geringe Wärmeausdehnung. Eignet sich besonders für Isolierteile, die starken Wärme- oder Kälteschocks widerstehen müssen.

STEKATHERM type 511 — A porous materia (clay-chamotte basis) with soapstone. A low thermal expansion factor and high thermal shock resistance up to 900° C.

STEKOR type 520 — A finely porous material with a high alumina content. High thermal shock resistance up to 1100° C. Its dielectric strength at higher temperatures is considerable.

STEKORIT type 410 — Consisting mainly of cordierite. Particularly low thermal expansion factor. Very suitable for insulating parts which have to resist strong heat and cold shocks.

Ovaj crtez e sopshtvenost na Electrolux-Bitola. Bez negovo pismo odobruvanje istiot nesmee da se prepisuva , umnozuva niti kopira . bez soglasnost od Electroluks vo sproftivno se snosat posledici vo smisla na clenovite 163 i 164 od kriticniot zakon R.M. (povreda na avtorisko pravo)

Adresa: ul.Braka Mingovi 18, 7000 Bitola; tel: 047/203-330 ,203 900ul.A.Guslarot.1a 02/329 8 130 Skopje

www.elektroluks.com. e-mail: elek-palenzo@mt.net.mk



Electrolux

INDUSTRIJA ZA EL. GREČNI
I GUMENI PROIZVODI

Hier die Gruppeneinteilung und die technischen Werte unserer keramischen Isolierstoffe für die Elektrotechnik nach DIN VDE 0335.

Gruppe Typ	C-100 111	C-200 220	C-200 221	C-200 240	C-400 410	C-500 511	C-500 520	C-600 610
Eigenschaften	mechanisch und elektrisch gut thermisch brauchbar	mechanisch sehr fest elektrisch gut kleiner Verlustfaktor		in gebranntem Zustand mit Werkzeugen bearbeitbar kleiner Verlustfaktor	sehr kleine Längenausdehnung große Temperaturwechselbeständigkeit	sehr kleine Längenausdehnung große Temperaturwechselbeständigkeit den besonderen Bedingungen der Elektrowärmegeräte angepaßt.		mechanisch gut hohe Wärmeleitfähigkeit sehr hohe Feuerfestigkeit
Hauptanwendungsgebiete	Niederspannungs-isolatoren und -isolierteile	Niederspannungsisolatoren und Isolierteile aller Art, besonders auch für die Hochfrequenztechnik Isolierkleinteile für die Elektrowärmetechnik, wie Reglersockel, Thermostatgehäuse Lampensockel		dünnwandige Röhren für Tauchsieder und Stabheizkörper	temperaturwechselbeständige Isolierteile Bauteile mit kleinster Längenausdehnung	Heizleiterträger für Elektrowärmegeräte und elektr. Industrieöfen Formteile für Funken- und Lichtbogenschutz indifferent gegen Heizleiterlegierungen und frei von Nachschwingung bis 900° C bis 1100° C		Isolierrohre aller Art Isolatoren für Zündkerzen
Wasseraufnahmevermögen (WA) %	0,1 bis 0,5	0	0	20	0	5 bis 10	3 bis 10	0
Rohrlichte – Raumdichte	2,3 bis 2,5	2,6 bis 2,8	2,6 bis 2,8	1,9 bis 2,1	2,1 bis 2,2	1,9 bis 2,1	≈2	2,6 bis 3,3
Biegefestigkeit kp/cm ²	300 bis 600	1200 bis 1600	1400 bis 1600	350 bis 600	500 bis 850	400 bis 500	500 bis 600	1200 bis 2200
Elastizitätsmodul kp/m ² in 10 ⁶	—	0,8 bis 1,1	1,1 bis 1,3	—	≈0,5	—	—	—

Längenausdehnungskoeffizient +20 und +100° C +20 und +600° C +20 und +1000° C grd ⁻¹ in 10 ⁶	3,5 bis 4,5 4 bis 5 4 bis 5	7 bis 9 7 bis 9 8 bis 10	6 bis 8 7 bis 9 8 bis 9	8,5 bis 9,5 ≈9 ≈9	≈1,0 2 bis 3 2 bis 3	3 bis 5 4 bis 6 4 bis 6	1,5 bis 3 2 bis 4 2,5 bis 5	5 bis 6 6 bis 8 7 bis 8
spezifische Wärmekapazität zwischen +20 und +100° C kcal kg grd	0,19 bis 0,21	0,19 bis 0,22	0,19 bis 0,22	≈0,21	0,20 bis 0,22	≈0,2	≈0,2	0,20 bis 0,25
Wärmeleitfähigkeit zwischen +20 und +100° C kcal hm grd	1,0 bis 1,4	2,0 bis 2,4	2,0 bis 2,4	1,2 bis 1,4	1,7 bis 2	1,1 bis 1,3	1,1 bis 1,5	2 bis 5
spezifischer Durchgangswiderstand bei Wechselspannung von 50 Hz (Wirkwiderstand) Ω cm bei 20° C 200° C 400° C 600° C 800° C 1000° C	— 10 ⁷ 10 ⁵ 10 ⁴ — —	5,10 ¹¹ 10 ¹⁰ 10 ⁷ 10 ⁵ — —	10 ¹² 10 ¹¹ 10 ⁹ 10 ⁷ 10 ⁶ 10 ⁵	— — 10 ⁵ 10 ⁷ 5,10 ⁵ 10 ⁵	— — 10 ⁶ 10 ⁴ — —	— — 5,10 ⁶ 10 ⁵ 10 ⁴ 5,10 ³	— — 10 ⁷ 5,10 ⁵ 10 ⁴ 5,10 ³	— 10 ⁹ 10 ⁶ 10 ⁵ ~10 ⁴ ~10 ³
Verhalten gegen Kriechstrom	Keramische Isolierstoffe erleiden unter Einwirkung eines elektrischen Funkens keine Veränderung ihrer Oberfläche, die zum Entstehen eines leitenden Kriechweges führen.							

Ovaj crtez e sopstvenost na Electrolux-Bitola.Bez negovo pismeno odobruvanje istiot nesmee da se prepisuva ,umnozuva niti kopira bez soglasnost od Electroluks vo sprobitno se snosaf posledici vo smisla na clenovite 163 i 164 od kriticniot zakon R.M. (povreda na avtorsko pravo)

Adresa: ul.Braka Mingovi 18, 7000 Bitola; tel: 047/203-330 ,203 900ul.A.Guslarot.1a 02/329 8 130 Skopje

www.elektroluks.com. e-mail: elek-palenzo@mt.net.mk



Electrolux

INDUSTRIJA ZA EL. GREAO
I GUMENI PROIZVODI

Ovaj crtež e sopstvenost na Electrolux-Bitola.Bez negovo pismeno odobruvanje istiot nesmee da se prepisuva , umnozuva niti kopira .bez soglasnost od Electroluks vo sproftivno se snosaf posledici vo smisla na clenovite 163 i 164 od kriticniot zakon R.M. (povreda na avtorsko pravo)

Dieses Prospektblatt zeigt nur einen unwesentlichen Ausschnitt aus unserem Fertigungsprogramm auf und dient in erster Linie der Information. Beinahe alle Isolierteile werden von uns nach kundenspezifischen Zeichnungen gefertigt. Das bedeutet: moderner Werkzeugbau, moderne Fertigungsmaschinen. Bitte kontaktieren Sie uns deshalb schon im Stadium einer Neuentwicklung, damit wir Ihnen entsprechende Konstruktionshinweise für werkstoffgerechte Gestaltung und eine wirtschaftliche Herstellung des Keramikkörpers vermitteln können.

Entwicklung kostet Geld. Auch hier können wir Ihnen durch Handmuster sparen helfen, um so teure Werkzeugkosten vorerst zu umgehen.

Nicht zuletzt gewährleisten wir Ihnen durch modern eingerichtete Fertigungsstätten, persönlichen Einsatz und Flexibilität eine preisgünstige und termingerechte Fertigung.

This brochure represents only a small selection from our production program. Almost all insulating parts are produced according to the customer's own technical drawings. This means: modern tool construction and modern production machines. For this reason, you should contact us during the early development stage so that we can offer you constructional tips regarding both material and design aspects, and also the economical production of the ceramic body.

Development is cost-intensive. Here too we can help you save money through hand samples — allowing you to get around expensive tool costs.

Last but not least, we can guarantee you low-cost customer-satisfying production based on state-of-the-art production systems, buyer-orientation and flexibility.

Adresa: ul.Braka Mingovi 18, 7000 Bitola; tel: 047/203-330 ,203 900ul.A.Guslarot.1a 02/329 8 130 Skopje

www.elektroluks.com. e-mail: elek-palenzo@mt.net.mk