

EMKA

Beschlagteile

Macedonia - Bitola

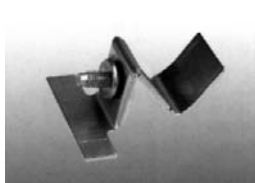
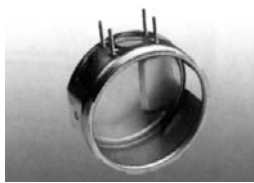
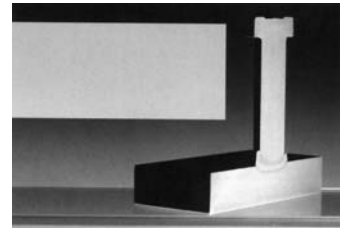
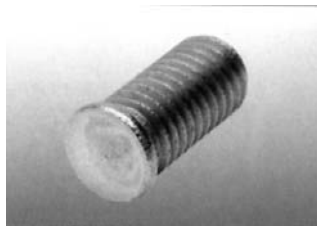
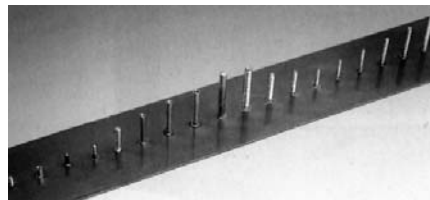
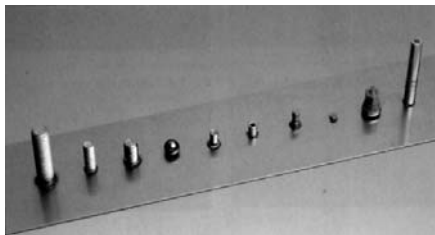

soyer e edna od svetskite kuži koji proizveduvaat vakvi elektro aparati za zavaruvawe na metali. Tehnologijata koja se koristi vo nivo e od najnov datum i rezultat na mnogugodi{nite ispituvawa i proizvodstvo na istite.

Aparatite slu`at za pricvrstuvawe na zavrтки, navrtki, klinovi i sli-ni elementi na druga metalna površina.

Se proizveduvaat pove}e verzii na aparati koji pokrivaat debelini na zavrќkata i sl. od 2 do 32 milimetri vo pre~nik, a kako dopolnitelna oprema postojat pove}e pomagala kako avtomatski dodava~ na navrtki pa duri do CNC avtomati.

Za pove}e informacii obratete se kaj zastapnikot.

Servis i prodavnica:
Bra}a Mingovi 18, Bitola
(stara ~ar{ija)
tel./faks: 097 / 30-633, 227-913
Magacin i prodavnica na golemo:
Dame Gruev 177, Bitola
(nas. mal pariz)
tel./faks: 097 / 30-877, 49-067

Zastapnik:

EMKA

Beschlagteile

Macedonia - Bitola

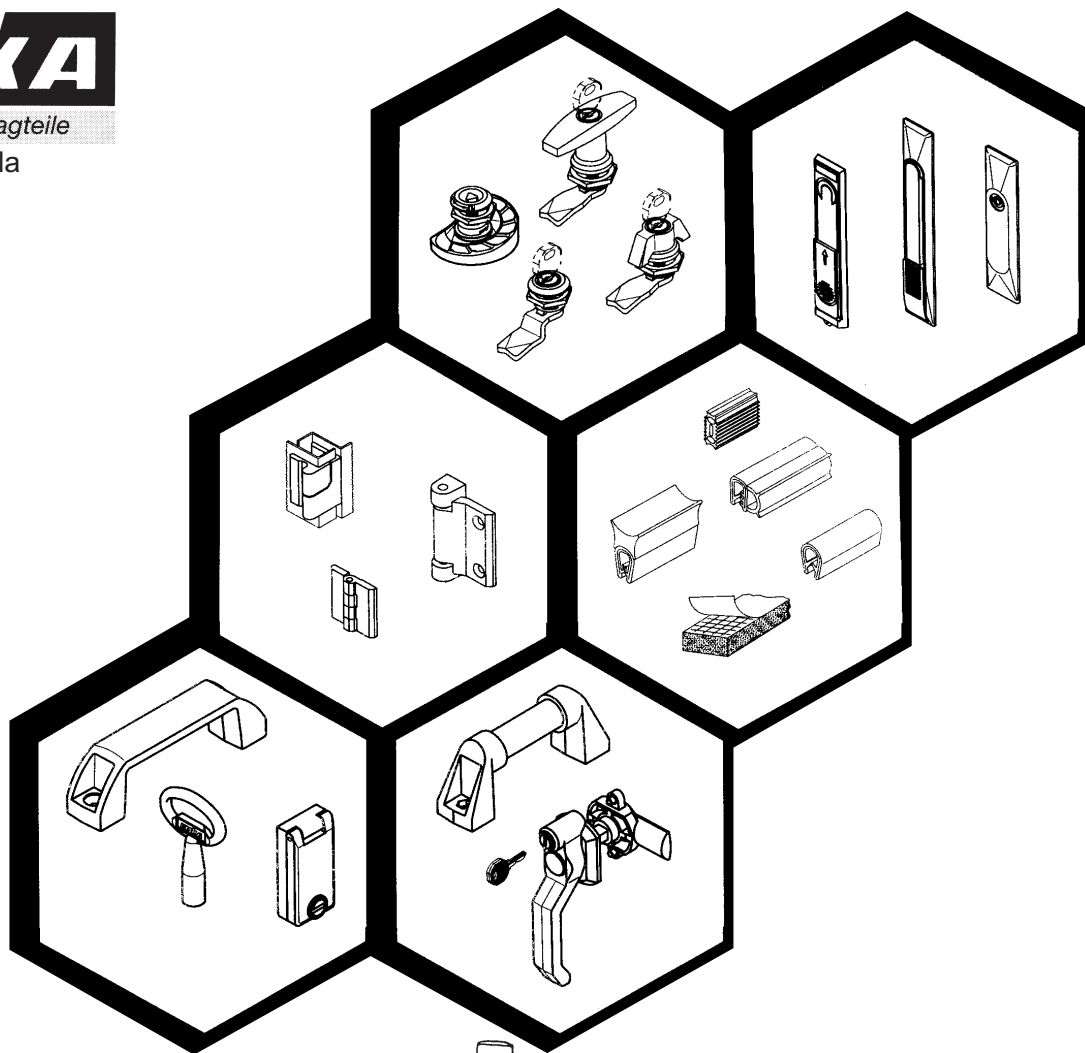

TAMA

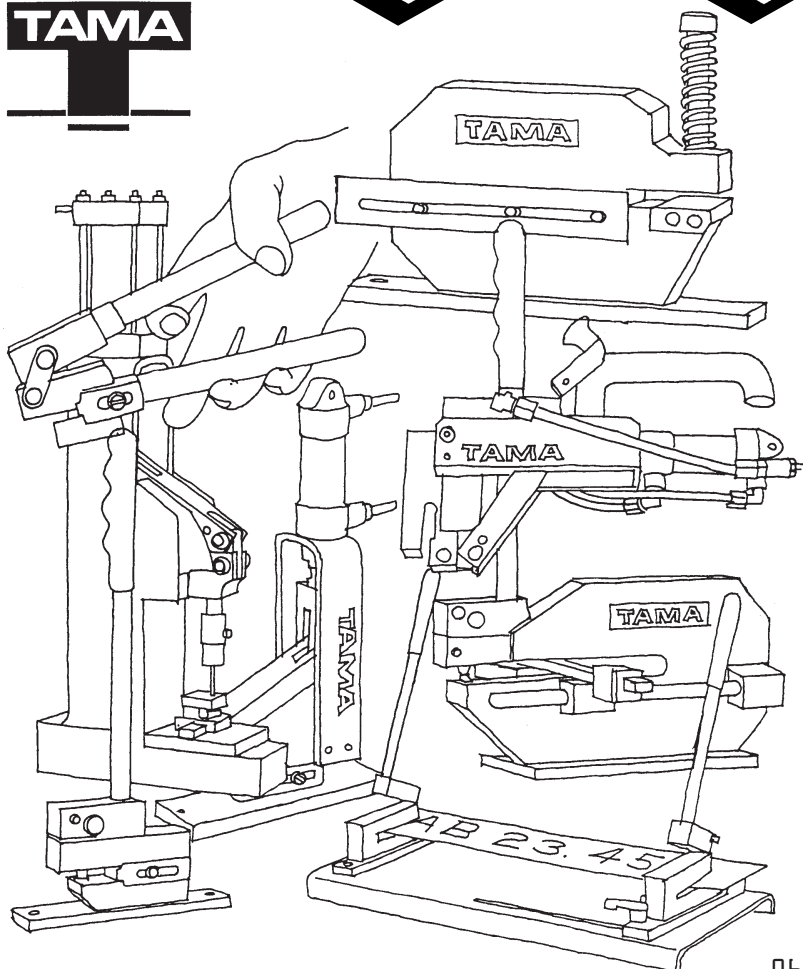

Servis i prodavnica:
Bra}a Mingovi 18, Bitola
(stara ~ar{ija)
tel./faks: 097 / 30-633, 227-913
Magacin i prodavnica na golemo:
Dame Gruev 177, Bitola
(nas. mal pariz)
tel./faks: 097 / 30-877, 49-067

060



ELEKTROLUKS

Direkcija i servis:
Braća Mingovi 18, Bitola
(stara arčija)
+ 389 97 / 30-633
mobil: 070 237-124

Fabrika:
Dame Gruev 177, Bitola
(nas. mal pariz)
+ 389 97 / 30-887
Kancelarija Solun (GR): 0977 677-165

Generalen zastapnik za:

