

FOR AIR



**Digital Flow Switch
Large Flow Rate Type**

Instruction Manual

PF2A7□H Series

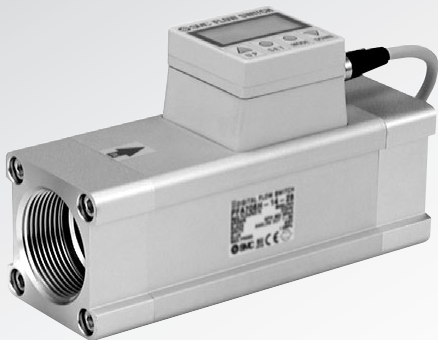

SMC Corporation

URL <http://www.smcworld.com>

CONTENTS

Thank you for purchasing the SMC PF2A7□H Series Digital Flow Switch.

Please read this manual carefully before operating digital flow switch and understand digital flow switch, its capabilities and limitations. Please keep this manual handy for future reference.

OPERATOR

- This operation manual has been written for those who have knowledge of machinery and apparatus that use pneumatic equipment and have full knowledge of assembly, operation and maintenance of such equipment.
- Please read this operation manual carefully and understand it before assembling, operating or providing maintenance service to the flow switch.

SAFETY	2
Model Indication Method	4
Name and Functions of Individual Parts	5
Installation	6
Example of Internal Circuit and Wiring	8
Setting	10
OUT1 Output Specifications	11
Function Setting	13
Other Functions	18
Specification	20
Full View with Dimensions	22

SAFETY

The Digital Flow Switch and this manual contain essential information for the protection of users and others from possible injury and property damage and to ensure correct handling. Please check that you fully understand the definition of the following messages (signs) before going on to read the text, and always follow the instructions.

IMPORTANT MESSAGES

Read this manual and follow its instructions. Signal words such as WARNING and NOTE will be followed by important safety information that must be carefully reviewed.

WARNING

Indicates a potentially hazardous situation which could result in death or serious injury if you do not follow instructions.

NOTE

Gives you helpful information.

WARNING

Do not disassemble, remodel (including change of printed circuit board) or repair.

An injury or failure can result.

Do not operate beyond specification range.

Fire, malfunction or switch damage can result.

Do not operate in a combustible gas or explosive gas atmosphere.

Fire or an explosion can result.

This flow switch is not an explosion proof type.

Do not use with a combustible fluid.

Otherwise, a fire or an explosion or damage may potentially result.

This flow switch is for air only.

NOTE

Follow the instructions given below when handling your flow switch. Otherwise, the switch may be damaged or may fail, thereby resulting in malfunction.

- Do not drop it, bring it into collision with other objects or apply excessive shock (490m/s² or more).
- Do not pull the lead wire with force nor lift the main unit by holding the lead wire. (Pulling strength less than 49N)
- Wiring correctly.
- Do not wiring while power is on.
- Do not wire with the same circuit of power line or high-voltage line.
- Do not use in a place in which water, oil, or a chemical is splashes.
- Install a filter and/or mist separator on the primary side (inlet side) if foreign matter is feared to mix in a fluid.
- Flush the dust in the piping with air blow before piping the switch.
- Do not push the setting buttons by a sharply pointed object.
- Apply the power supply when the flow rate is zero.
- Start measurement by the flow switch three seconds after turning on the power.
- Maintain the switch status for measurement output before setting when initializing or setting a flow rate of the flow switch. Measure after checking impacts to the equipment.
- Opening and closing of flow passage by restrictor should be within max. measured flow rate value.

Model Indication Method

PF2A7□H-□□-□□□

Unit Specification

No Symbol: Unit selection function provided

-M: SI units fixed

Lead Wire Specification

No Symbol: Lead wire with connector 3m

N: None Lead wire with connector

Output Specification

28: NPN open collector 1output
+ Analog output (1 to 5V)

29: NPN open collector 1output
+ Analog output (4 to 20mA)

68: PNP open collector 1output
+ Analog output (1 to 5V)

69: PNP open collector 1output
+ Analog output (4 to 20mA)

Piping Port

10: Port size 1 (Applicable for PF2A703H)

14: Port size 1 · 1/2 (Applicable for PF2A706H)

20: Port size 2 (Applicable for PF2A712H)

Port Screw Type

No Symbol: Rc **N:** NPT **F:** G

Flow Rate Range

03: 150 to 3000 ℓ/min

06: 300 to 6000 ℓ/min

12: 600 to 12000 ℓ/min

NOTE1:

The revised Measurement Law of Japan does not allow use of meters or measuring instruments, which have a unit selection function, in Japan.

NOTE2: The fixed unit

For instantaneous flow rate is : ℓ/min

For integrated flow rate is : ℓ, m³, m³ × 10³

Names and Functions of Individual Parts

Display Part

Output(OUT1)Lamp : Lit when OUT1 is ON.

Flickers when an overcurrent error occurs.

Flow display : Instantaneous flow, accumulated flow and set value are displayed.

Flow check display : Flickering interval varies depending on the flow.

Unit display : Selected unit is displayed. Single unit type is displayed in SI unit (ℓ/min or ℓ, m³, m³ × 10³).

▲ Button (UP) : Selects a mode and increases a set ON/OFF value.

▼ Button (DOWN) : Selects a mode and decreases a set ON/OFF value.

MODE Button (MODE) : Changes the mode.

SET Button (SET) : Changes the mode and sets a set value.

* RESET

Pressing the ▲ and ▼ buttons simultaneously will activate the RESET function. Use this function to clear errors when a trouble occurs.

Body

Flow switch sensor body.

The arrow on the side of the body indicates the direction of flow.

Piping port

This port connects with pipeline. Use a pipe fitting to connect with external pipeline.

Accessories

(When no symbol is specified for wiring in the type specification)

Lead wire with connector on one end (3 m in length)

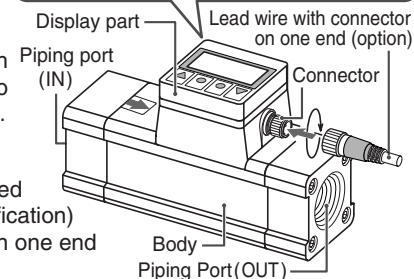
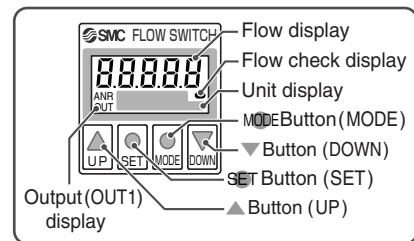

Installation

Before you mount a flow switch, read "SAFETY" and "Installation" described in this chapter carefully to obtain safe and correct measurement.

Mounting

- Use this flow switch under the specified operating pressure range.
- Use this flow switch under the specified operating temperature range.
- Withstand pressure is 2.25 MPa.
- Do not install a flow switch at a foothold position.
- Install a flow switch so that the flow direction agrees with the arrow direction on the side of the body.
- Mount the body so that the bottom of the body does not face upward.
- Provide a straight pipe length of more than eight times the pipe diameter to upstream and downstream of the flow switch.
- Set Display Part proper position taking the cable entry and display position into account. Display Part rotates in 270 degree.

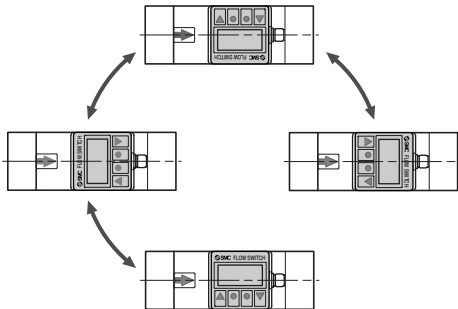

Piping connections

- Observe the specified tightening torque when connecting pipes. Refer to the following table for the appropriate torque values.

Nominal size of screws	Appropriate tightening torque (N·m)
Rc 1	36 to 38
Rc 1 · 1/2	48 to 50
Rc 2	48 to 50

- When connecting pipeline to the switch, apply a spanner to the metal part of the piping section for the switch.
- Make sure that sealing tapes will not enter inside the pipe when connecting pipes.

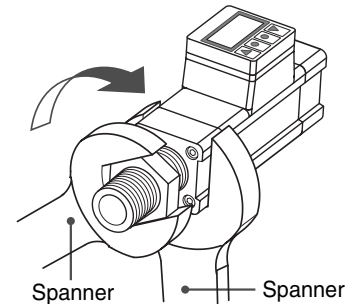

Example of Internal Circuit and Wiring

Output Specification

When the Lead wire with connector provided by SMC corporation is used the color of wire (Brown, white, Black, Blue) shown on circuit diagram will be applied.

—28, —29

NPN open collector 1 output + Analog output
Max. 30V, 80mA Internal voltage drop : 1V or less

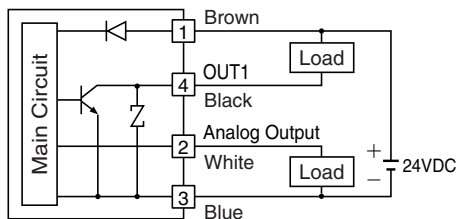

—68, —69

PNP open collector 1 output + Analog output
Max. 80mA Internal voltage drop : 1.5V or less

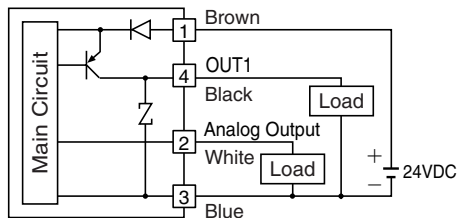

PF2A7□H-□-28/68

Output : 1 to 5V

PF2A7□H-□-29/69

Output : 4 to 20mA

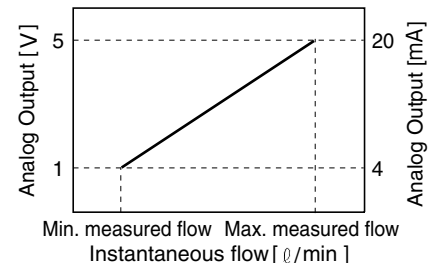

Model No.	Min. measured flow (ℓ/min)	Max. measured flow (ℓ/min)
PF2A703H	150	3000
PF2A706H	300	6000
PF2A712H	600	12000

- Turn off power before connecting or disconnecting the connector.
- To insert the connector, push the connector socket of the lead wire to the key part of the switch connector after aligning them to each other and secure the connector with the lock nut.
- To disconnect the connector, unlock the connector lock nut and pull out the connector straight.
- Install the lead wire separately from the route for power cable or high-voltage cable. Otherwise, malfunction may potentially result due to noise.

Connector pin number

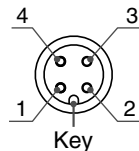

Pin No.	Pin name
1	DC(+)
2	Analog Output
3	DC(-)
4	OUT1

Setting

Setting Procedure: Check installation condition and wiring and set as below

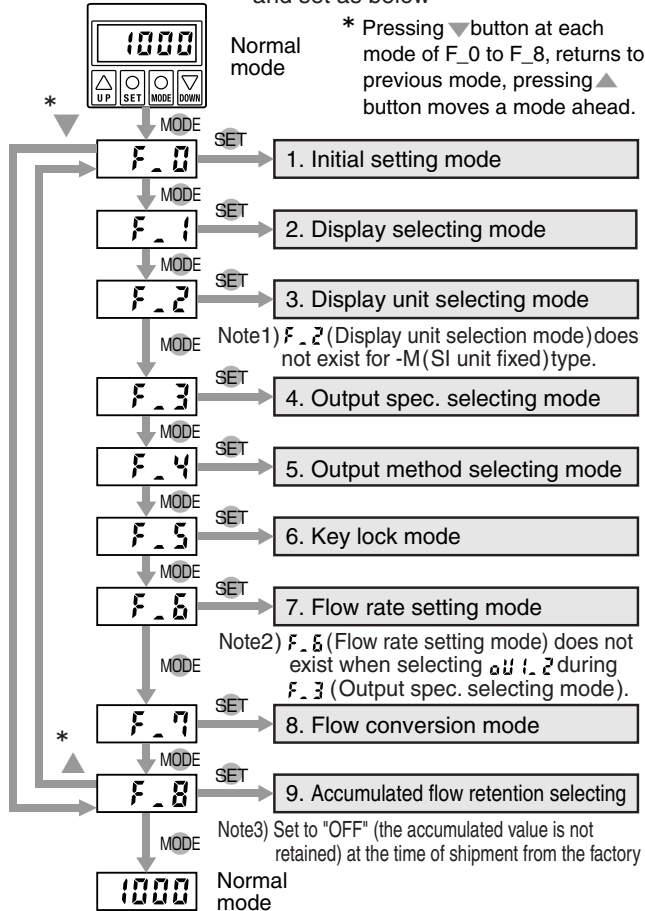

OUT1 Output Specifications

Instantaneous switch output (oU1_0)

See "Flow rate setting mode" to input setting value.

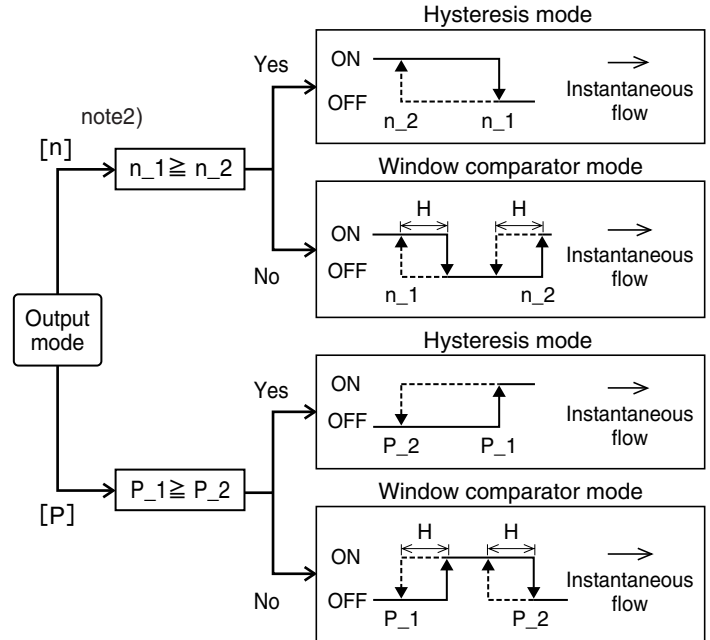

OUT1 Output Specifications (continue)

Accumulated switch output (oU1_1)

See "Flow rate setting mode" to input setting value.

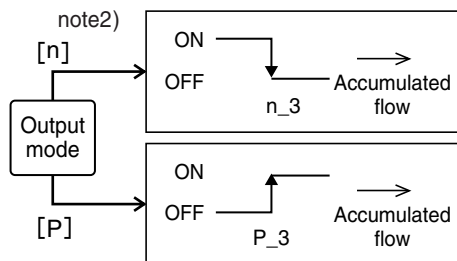

Accumulated Pulse output(oU1_2)

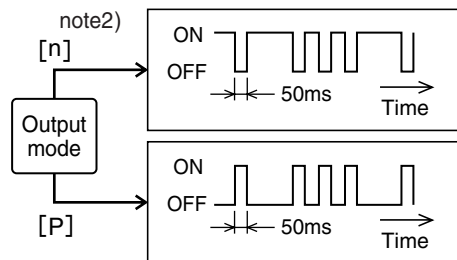

Flow rate per pulse note1)

Display	Accumulated flow
U_1	100 ℓ/pulse
U_2	10.0 ft ³ /pulse

Note1) Unit selection function type

(Unit is fixed to SI unit for the type without this function)

Note2) Reversed output is assigned at shipment.

Function Setting

1. Initial setting mode

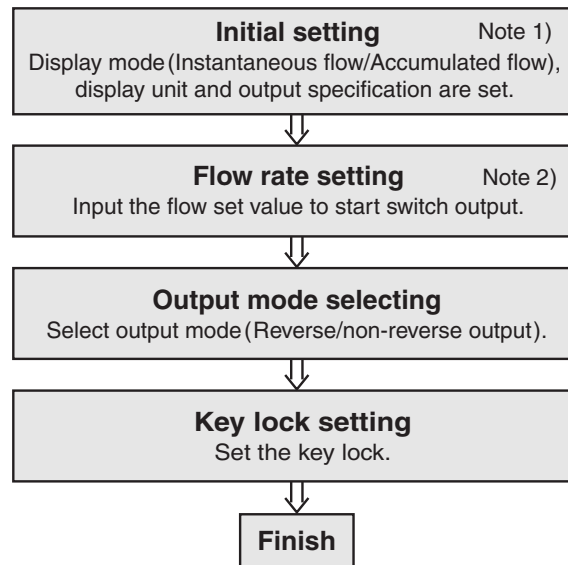

Note1) Display unit setting is not started when the model indication specifies the unit as "-M".

Note 2) It does not go into Flow rate setting mode when the accumulated pulse output [oU1_2] is selected as output specification.

2. Display selecting mode

Select the display from instantaneous flow or accumulated flow. Press ▲ button to select desired flow, then press SET button.

[d_1] means instantaneous flow, [d_2] accumulated flow.

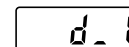

3. Display unit selecting mode

Display unit can be selected when the unit spec. of model Indication is No Symbol. -M means the unit is fixed to SI unit. It does not go into Display unit selecting mode. See "Display unit selecting mode" below for details.

Display unit selecting mode

(When Unit spec. in Model Indication is w/o "M")

Unit can be selected from that of Instantaneous flow and accumulated flow. The unit is changed by pressing **▲** button.

It will be set up if the **SET** button is pressed.

If the **MODE** button is pressed instead of the **SET** button, it will change to [F_3] .

Display	Instantaneous flow	Accumulated flow
U_1	ℓ/min	ℓ, m ³ , m ³ ×10 ³
U_2	CFM	ft ³ , ft ³ ×10 ³ , ft ³ ×10 ⁶

4. Output specification selecting mode

oU1_0

Set OUT1 output specifications.

Press **▲** button to select OUT1 output spec., then press **SET** button. [oU1_0] indicates instantaneous switch output, [oU1_1] accumulated switch output and [oU1_2] accumulated pulse output.

See "OUT1 output specifications".

Input the set value after selecting OUT1 output specifications. See "7. Flow rate setting mode" for details.

Flow setting not required when selecting accumulated pulse output [oU1_2] .

5. Output method selecting mode

Set OUT1 output mode. Reverse output and non-reverse output mode are available for output.

oU1_P

* Press **▲** button to select the mode from reverse output or non-reverse output. And press **SET** button is to set.

[oU1_n] indicates reverse output mode, [oU1_P] is non-reverse output mode.

Pressing **MODE** button instead of **SET** button switches to [F_5] .

6. Key lock mode

Prevents wrong operation such as unintentional change of set value.

LOCK

- Press **SET** button, and the display changes from [F_5] to [unL].
- Set the display as [Loc] by **▲** button
- Mode changed to [F_6] by pressing **MODE** button. ([F_7] when selecting [oU1_2] during [F_3])
- Setting completed by pressing **SET** button.

unL

Loc

RELEASE

- Press **MODE** button longer than 3 sec. at the normal mode to display [F_5] , then press **SET** button.
- Press **▲** button to display [unL] .
- Setting completed by pressing **SET** button.

7. Flow rate setting mode

Input set value. Input method depends on OUT1 output specification. It does not go into Flow rate setting mode when the accumulated pulse output is selected as OUT1.

Instantaneous switch output (oU1_0)

1. Press **SET** button to input n_1(P_1) set value. [n_1] and the set value appears in turn if previous setting select reverse output mode. ([P_1] and the set value appears in turn when non-reverse output mode is selected)
2. Select set value by **▲** button or **▼** button. **▲** button to increase the value, **▼** button to reduce.

3000
oU1- L/min-

Function Setting (continue)

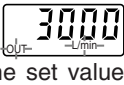
3. Press **SET** button to input n₂(P₂) set value. 
[n₂] and the set value appears in turn if previous setting select reverse output mode. ([P₂] and the set value appears in turn when non-reverse output mode is selected)

4. Select the set value by ▲ and ▼ button as in 2. above.

5. Press **SET** button to set the value.

6. *n₁ < n₂ (P₁ < P₂): Window comparator mode [HIS] and hysteresis value appears in turn.

Press **SET** button after selecting hysteresis with ▲ or ▼ button.



▲ button to increase the value, ▼ button to reduce.

0 to 3% of rated flow value is adjustable as hysteresis value. If the difference between n₁(P₁) and n₂(P₂) is smaller than 6% of rated flow, max. set value of hysteresis is the half of the difference between n₁(P₁) and n₂(P₂).

Also, if hysteresis is set over 3%, an error indication "Error" appears.

- *n₁ ≥ n₂ (P₁ ≥ P₂): hysteresis mode
Hysteresis value is not set.

Accumulated switch output (oU1_1)

The value can be set up to 9999[m³ × 10³], 999[m³], 999[ℓ].

1. Press **SET** button to input the set value in the digit of [ℓ].

The set value and P₃(or n₃) appears in turn, an "OUT" and "L" flicker.

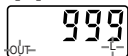

* Press **SET** button longer than 3 sec. to complete setting.

2. Select set value with ▲ and ▼ button. ▲ button to increase the value, ▼ button to reduce.

3. Press **SET** button to input the set value in the digit of [m³].

The set value and P₃(or n₃) appears in turn, an "OUT" and "m³" flicker.

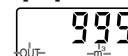

* Press **SET** button longer than 3 sec. to complete setting.

4. Select the set value by ▲ and ▼ button as in 2. above.

5. Press **SET** button to input the set value in the digit of [m³ × 10³]. The set value and P₃(or n₃) appears in turn, an "OUT" and "m³ × 10³" flicker.

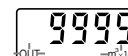

* Press **SET** button longer than 3 sec. to complete setting.

6. Select the set value by ▲ and ▼ button as in 2. above.

7. Press **SET** button to return to the status of 1. above.

Press **SET** button longer than 3 sec. to complete setting.

8. Flow conversion mode

Displays air flow converted during standard condition (Anr: 20°C, 101.3kPa, 65%RH[ANR]), and datum condition (nor:0°C, 101.3kPa).

1. Press **SET** button, and switch with ▲ button. "Anr" indicates standard condition, "nor" datum condition.

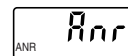

2. Press **SET** button or **MODE** button to complete the setting.

9. Accumulated retention function selecting mode

The accumulated flow is set to be cleared when the power supply is turned off. It can be changed to be memorized every approx. 4 min.

The accessible number of the memory is 1 million, and it should be considered for the setting.

1. Press **SET** button and change ▲ button.

When "oFF" is displayed, the accumulated flow is not memorized.

When "on" is displayed, the accumulated flow is memorized.

2. Press **SET** button or **MODE** button to complete setting.

Other Functions

Flow display check

Check accumulated flow when instantaneous flow is selected

Accumulated flow is displayed only during ▼ button is pressed.
(Returns to instantaneous flow when releasing ▼ button.)

* The unit of accumulated flow is changed as [L] → [m³] → [m³ × 10³] → [L] if press ▲ button while pressing ▼ button.

Check instantaneous flow when accumulated flow is selected

Instantaneous flow is displayed only during ▼ button is pressed.
(Returns to accumulated flow when releasing ▼ button.)

Switching the unit of accumulated flow display

Set the accumulated flow display unit while accumulated flow is selected.

1. Unit flickers by pressing ▲ button.
2. The unit is changed as [L] → [m³] → [m³ × 10³] → [L] by ▲ button.
3. Unit stops flickering when deciding the unit by SET button.
* The unit stops flickering unless pressing button for 8 sec., and complete switching the flow display unit. Accumulated flow display unit is not switched.

Clear of Accumulated Value

Accumulated value is cleared by pressing ▲ button pressing ▼ button for 6 sec.

Initialize the Set Value

All the setting can be initialized to values at shipment.

Press ▲ button and ▼ button for longer than 2 sec. during initial setting mode [F_0]. Press SET button after [F_00] appears.

* Setting is not initialized but switched to [F_0] if pressing MODE button. See below for setting at shipment.

Display setting : Instantaneous flow (d_1)

Unit setting : ℓ/min (U_1)

Switch spec. : Instantaneous switch output (oU1_0)

Flow setting value : Instantaneous flow Intermediate value of full-range/Accumulated flow 0

Output mode : Reverse output (oU1_n)



Key lock mode : Unlocked (unL)

Flow conversion condition : 20°C, 101.3kPa,
65%RH[ANR](Anr)

Accumulated flow retention: The value is not memorized (Off)

Error Display and Troubleshooting

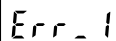
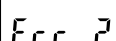
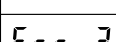
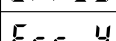
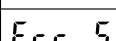
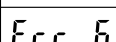
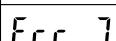
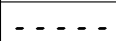
This function displays error location and nature. When a problem or an error occurs, take the following actions.

LED display	Error Nature	Troubleshooting
	A current exceeding 80 mA is flowing to OUT1.	Turn the power off. Check the load and wiring of OUT1.
	The condition has returned to the one before adjusted at a factory. The internal circuit could be damaged.	Stop using and consult our local sales branch.
	Set data has been changed due to some reason.	Reset all the data.
	A system error occurs. The internal circuit could be damaged.	Stop using and consult our local sales branch.
		
		
	A fluid flow is higher than rated rate.	Reduce the flow down to the rated rate.
		
	The flashing indication of accumulated flow rate means that the accumulated value exceeds maximum accumulated flow rate and enters the second round.	Clear the accumulated value.

To reset display of Error 1 and 3, press ▲ and ▼ button simultaneously. The error indication changing from 1 through 7 means that the internal circuit has broken. In this case, stop using and consult our local sales branch.

Specification

Model	PF2A703H	PF2A706H	PF2A712H
Flow Rate Indication/Range	Dry air		
Flow rate indication range (ℓ/min)	125 to 3025	250 to 6050	550 to 12050
Set flow rate range (ℓ/min)	125 to 3025	250 to 6050	550 to 12050
Measured flow rate range (ℓ/min)	150 to 3000	300 to 6000	600 to 12000
Measured min unit (ℓ/min)	5	10	
Flow rate converted score of accumulated pulse	100 ℓ/pulse		
Accumulated flow rate range	0 to 9,999,999,999 ℓ		
Indication Unit (*1,2)	Instantaneous flow rate : ℓ/min, CFM Accumulated flow rate : ℓ, m ³ , m ³ ×10 ³ , ft ³ , ft ³ ×10 ³ , ft ³ ×10 ⁶		
Operating fluid temp.	0 to 50°C (No condensation or freezing)		
Linearity	Indicated value	±1.5%F.S. or less	
	Analog output	±3%F.S. or less	
Power supply voltage	24VDC, ripple±10% or less		
Current consumption	150mA or less (No load)		
Repeatability	±1.5%F.S. or less (0.7MPa, 20°C)		
Hysteresis	Hysteresis mode : Variable (Settable starting 0) Window comparator mode : Set for 0 to 3%F.S.		
Response time	1s or less		
Detecting method	Thermal sensing		
Withstanding pressure	2.25MPa		
Operation indication range	0.1 to 1.5MPa		
Indication digit	5digits 7segment LCD		

*1) With a unit selection function (Without a unit selection function, fixed to SI unit [ℓ/min or ℓ, m³, m³×10³])

*2) Flow rate indication is possible to be switched to normal condition of 0°C/101.3kPa and standard condition of 20°C/101.3kPa/65%RH (ANR)

Model	PF2A703H	PF2A706H	PF2A712H
Output specification (*3)	Switch output	[NPN open collector] Max. load current : 80mA, Internal voltage drop : 1V or less (At load current 80mA), Max. input voltage : 30VA	
		[PNP open collector] Max. load current : 80mA, Internal voltage drop : 1.5V or less (At load current 80mA)	
	Accumulated pulse output	NPN/PNP open collector (Same as switch outputs)	
	Analog output	Voltage output : 1 to 5V (within rated flow range) Linearity : ±3%F.S. or less Permissible load impedance : 100kΩ or more	
Current output : 4 to 20mA (within rated flow range) Linearity : ±3%F.S. or less Permissible load impedance : 250Ω or more			
Enclosure	IP65		
Ambient temperature range	Operation : 0 to 50°C, Storage : -25 to 85°C (No condensation or freezing)		
Withstand voltage	1000VAC, 1minute (between lead block and case)		
Insulation resistance	50MΩ or less (at 500VDC M) (between lead block and case)		
Noise resistance	1000Vp-p pulse width 1μs first transition 1ns		
Vibration proof	10 to 500Hz smaller one 1.5mm or 98m/s ² , double amplitude, each in directions of X,Y and Z 2hours		
Impact proof	490m/s ² , 3 tomes each in directions of X,Y and Z		
Temp. characteristics	±2.0%F.S. or less (0 to 50°C, 25°C standard)		
Material	Attachment : A6063, Packin : H-NBR, Spacer : PPS, Mesh : SUS, Inner body : A6063, Sensor case : PPS, Sensor : Leaded glass/ptlr/FeNi/OFC		
Port size	1	1 · 1/2	2
Mass (Weight) (*4)	1.1kg	1.3kg	2.0kg

*3) Switch output and accumulated pulse are selected at initial setting.

*4) Except lead wire.

Full View with Dimensions (in mm)

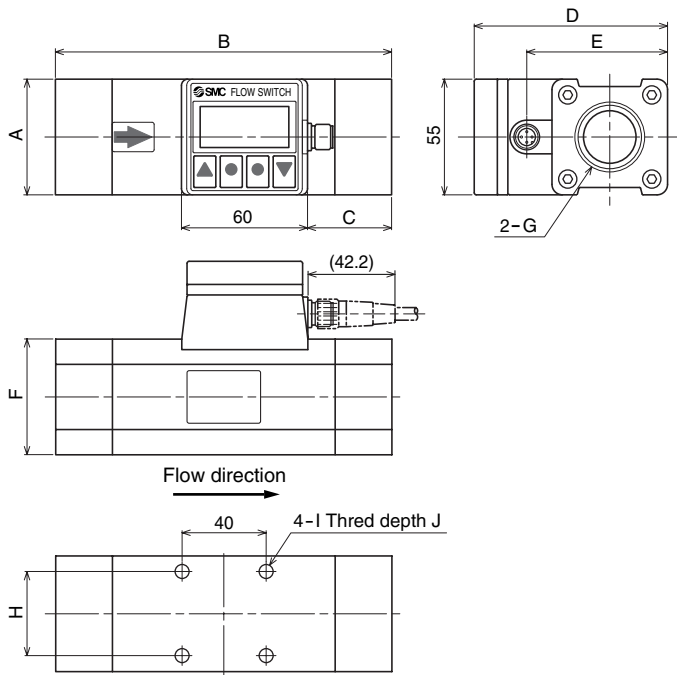

Thred G

PF2A703H	Rc1, NPT1, G1
PF2A706H	Rc1·1/2, NPT1·1/2, G1·1/2
PF2A712H	Rc2, NPT2, G2

Model No.	A	B	C	D	E	F	H	I	J
PF2A703H	55	160	40	92	67	55	36	M5×0.8	8
PF2A706H	65	180	45	104	79	65	46	M6×1	9
PF2A712H	75	220	55	114	89	75	56	M6×1	9