



INSTRUCTIONS FOR USE OF THE FOLLOWING VESTA PRODUCTS

IL PRESENTE MANUALE DI USO E MANUTENZIONE È VALIDO PER I SEGUENTI PRODOTTI VESTA:

COILS SINGLES OR ASSEMBLED ON VALVES / SOLENOIDI SINGOLI O ASSEMBLATI SU ELETTROVALVOLE:

MS11050, MS22050, CS11050, CS22050, SCN11050, SCN22050

Please pay attention to the following Vesta products:

Coil and connector offer protection from dust and water to IP65 only when correctly installed with the fixing screw and rubber gasket which are supplied as standard (grommet, coil seal, "O" ring).

Prescrizioni di montaggio per preservare il grado di protezione IP65

Per preservare il grado di protezione IP65 del collegamento elettrico è necessario eseguire il montaggio nel seguente modo:

- Prima di effettuare il collegamento elettrico dei cavi al connettore infilare nel cavo stesso il pressacavo avvitando il serracavo sul connettore.
- Montare la guarnizione bobina fra bobina e connettore, quindi fissare il connettore alla bobina con l'apposita vite, avvitandola adeguatamente.
- Montare quindi la bobina sulla valvola posizionando l'anello di tenuta (OR) nell'apposita sede della bobina.

Ground connection

Ground connection must be secure and adequate.

Messa a terra

La bobina prevede il morsetto a terra che deve essere collegato opportunamente all'impianto di messa a terra dell'installazione che deve essere realizzata a regola d'arte.

Electrical connection

When choosing the cable for electrical connections, take into account the location and environment of the installation (ex. Following the CEI 60204-1 standard).

Collegamento elettrico

I conduttori utilizzati per il collegamento devono essere scelti e montati a regola d'arte tenuto conto dell'ambiente e delle condizioni di utilizzo nonché delle caratteristiche elettriche di impiego (tensione e corrente di esercizio). Si consiglia di seguire, ove applicabile, la pertinente normativa applicabile (ad es. CEI EN 60204-1).

Should the above instructions not be followed to the letter Vesta Automation will not be hold responsible.

L'installatore e l'utilizzatore sono tenuti ad attenersi scrupolosamente alle indicazioni impartite.

Qualsiasi omissione solleva Vesta Automation s.r.l. da ogni responsabilità e danno conseguenti.

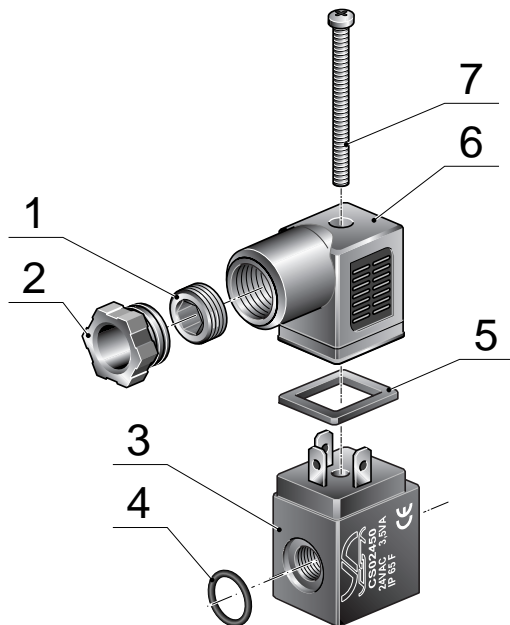

Coils and accessories for solenoid valves.
Solenoidi ed accessori per elettrovalvole.

Position Posizione	Description Descrizione
1	Grommet / Pressacavo
2	Gland nut / Serracavo
3	Solenoid coil / Bobina
4	O-Ring / OR
5	Coil seal / Guarnizione bobina
6	Connector / Connettore
7	Fixing screw / Vite

BUILDING FEATURES / CARATTERISTICHE COSTRUTTIVE

Series **K** mini-valves and solenoid valves are built in compact dimensions and are capable to be assembled on manifolds. In order to assure their performance, particular care and attention have been offered in developing each component for this product. Possibility to operate continuously without lubrication (**A**).

The spool is manufactured in a light alloy (**B**).

This offers lasting durability and a high working frequency (**E**): due to the manufacturing of the internal moving parts, inertia and friction are greatly reduced, and a better resistance to the external aggressive agents is assured by the nickel treatment (**C**).

The nominal air flow of the valve is around 690 NI/min (**D**), despite of its small dimensions.

The solenoid valves, complete with coil and connector, follows EEC directives on the electromagnetic compatibility (89/336/EEC) and low voltage (73/23/EEC).

Le mini valvole ed elettrovalvole Vesta serie K funzionano secondo il principio del cassetto bilanciato (vedi fig. 1 e 2), presentano ingombri molto ridotti e la possibilità di assemblaggio in batterie compatte.

*Particolare cura è stata prestata nella progettazione e realizzazione di ogni singolo componente del prodotto, al fine di consentire elevate prestazioni funzionali. Caratteristiche comuni a tutte le valvole della serie sono l'alta velocità di scambio (**E**), la possibilità di funzionamento continuo privo di lubrificazione (**A**) ottenuto con l'impiego di materiali particolari come, ad esempio, la spola, realizzata in lega leggera (**B**), ed il corpo, in alluminio trattato al nichel (**C**). Tutto ciò garantisce una elevata frequenza di lavoro e una lunga vita del sistema, grazie ad una riduzione dell'inerzia delle parti mobili, ad una riduzione degli attriti interni e ad un maggior grado di resistenza agli agenti aggressivi esterni. Particolarmente interessante, nonostante le ridotte dimensioni, la portata nominale: 690 NI/min. (**D**).*

Le elettrovalvole complete di bobina e connettore, sono conformi alle direttive CEE relative alla compatibilità elettromagnetica (89/336/CEE) ed alla bassa tensione (73/23/CEE).

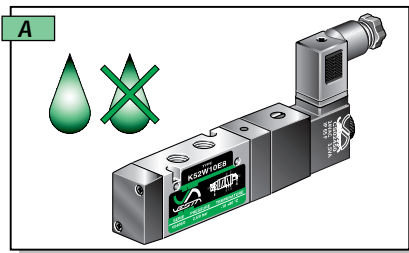

Possibility to operate continuously without lubrication.

Possibilità di funzionamento continuo privo di lubrificazione.

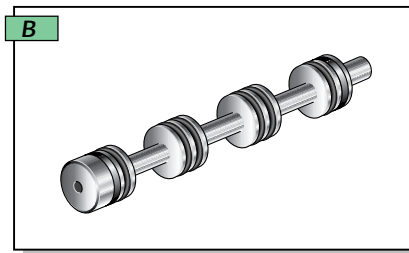

Light alloy spool.

Spola in lega leggera.

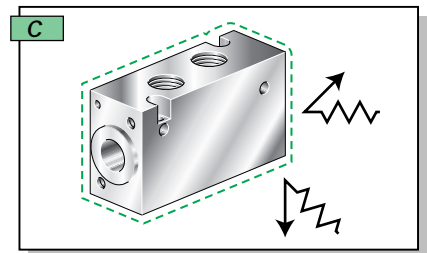

Nickel treated body.

Corpo in alluminio trattato al nichel.

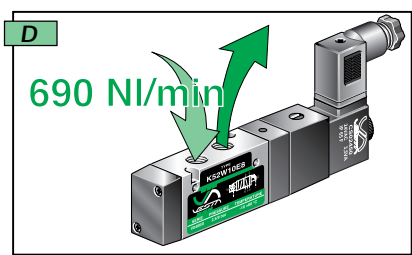

Nominal air flow: 690 NI/min.

Alta portata nominale: (690 NI/min a 6 bar).

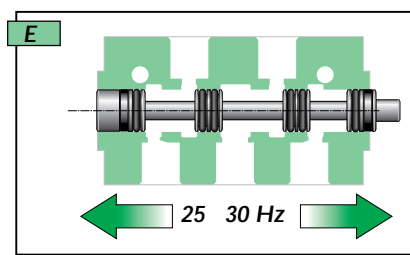

High working frequency.

Alta velocità di scambio.

WORKING PRINCIPLE / PRINCIPIO DI FUNZIONAMENTO

In the example here below (**K52W1018-02450** - 5/2 valve, single solenoid, spring return), when the valve stands in the normal position, ports **4 - 5** and **1 - 2** are connected and the position is kept thanks to the pressure assured to the smallest piston and to the spring force (right side of the valve). When the valve is actuated, the same pressure is fed to the biggest piston. Its bigger surface create a force which allows to the spool to move and therefore to connect ports **4 - 1** and **2 - 3**. Spring return assures (grant) the normal position of the spool even if no pressure is brought to the valve.
In the bistable versions, the position of the valve remains in its last switched state.

Il principio di funzionamento del distributore 5/2 (nell'esempio l'elettrovalvola **K52W1018-02450** con comando elettropneumatico e riposizionamento a molla) consiste nel mantenere la spola in posizione di riposo per azione sia di una molla meccanica che per effetto della pressione creata dalla fonte d'aria compressa presente nel condotto di alimentazione **1** sulla spola stessa (fig. 1) collegando le vie **1- 2** e **4 - 5**.

L'eccitazione del solenoide mette in comunicazione il condotto **1** con la camera dove è alloggiato il pistone di comando. Quest'ultimo contrasta l'insieme delle forze create dalla molla e dalla pressione sul lato opposto della spola, spostandola in modo tale da collegare i canali **1 - 4** e **2 - 3** (fig. 2).

Diseccitando il solenoide si ripristina la posizione iniziale. La combinazione del sistema a molla meccanica con il riposizionamento pneumatico consente di avere sempre la spola in posizione di riposo anche dopo la caduta di pressione del sistema.

Nei sistemi bistabili (doppio comando elettropneumatico o doppio comando pneumatico) in assenza di segnale rimangono i collegamenti formati nell'ultimo azionamento.

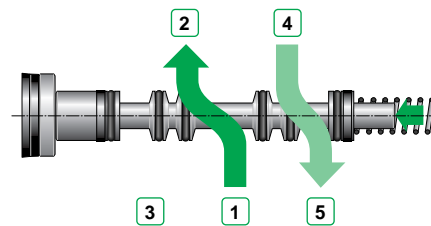
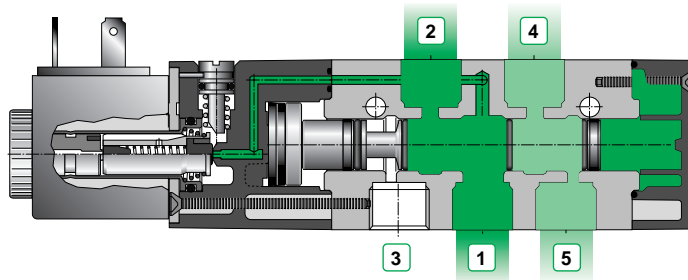

fig. 1

NORMAL POSITION / POSIZIONE A RIPOSO

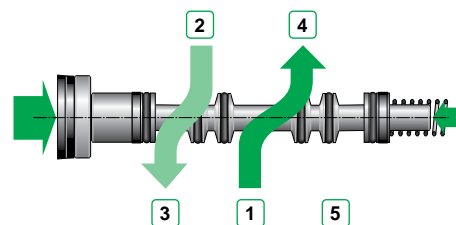
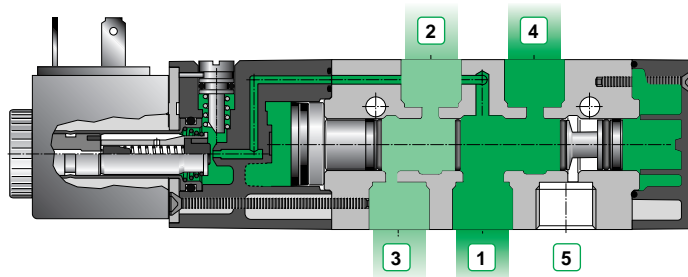
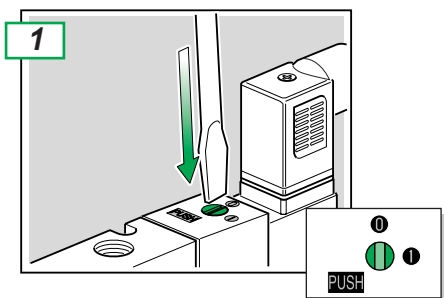

fig. 2

ACTUATED POSITION / POSIZIONE DI LAVORO

MANUAL OVERRIDING / AZIONAMENTO COMANDO MANUALE



Push to actuated valve without locking. **Relise the button to get back to normal position.**

Per azionare la valvola, durante la fase di collaudo con pressione in linea senza collegamento elettrico, usare un adeguato cacciavite per premere la vite del comando manuale. Rilasciare per ripristinare la condizione di riposo.

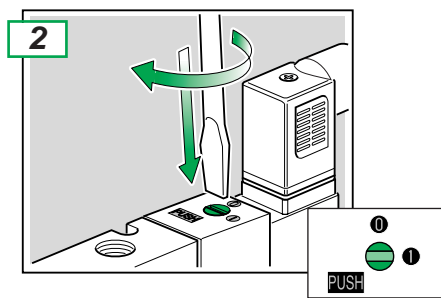

To active the valve permanently, push the M/O using a screwdriver and rotate clockwise 90°.

Per azionare la valvola in modo permanente premere la vite del comando manuale e ruotare in senso orario sino alla posizione 1.

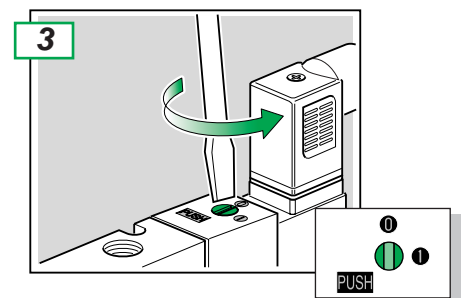

To get back to normal position push the M/O again and turn 90° anti-clockwise.

Ruotare in senso antiorario la vite del comando manuale per ripristinare la condizione di riposo.



SERIE K TECHNICAL FEATURES / CARATTERISTICHE TECNICHE

COMMON TECHNICAL FEATURES K SERIE / CARATTERISTICHE TECNICHE COMUNI SERIE K

Port connections	G1/8, G1/4	Conessioni di lavoro.....	G1/8, G1/4
Flow section	G1/8" = Ø 6 mm	Diametro nominale.....	G1/8" = Ø 6 mm
	G1/4" = Ø 8 mm		G1/4" = Ø 8 mm
Environment temperature range	-10 °C ÷ +50 °C	Temperatura ambiente.....	-10 °C ÷ +50 °C
Temperature range of medium	0 °C ÷ +40 °C	Temperatura fluido.....	0 °C ÷ +40 °C
Lubrication	Not required	Lubrificazione.....	Non necessaria
Medium	Filtered air	Fluido.....	Aria filtrata
Reference pressure	6 bar	Pressione nominale.....	6 bar
Nominal air flow 3/2 and 5/2 valves (valvole 5/3).....	G1/8": 690 (552) NI/min	Portata nominale valvole 3/2 e 5/2 (valvole 5/3).....	G1/8": 690 (552) NI/min
	G1/4": 1300 (1040) NI/min		G1/4": 1300 (1040) NI/min

PNEUMATIC VALVES FEATURES / CARATTERISTICHE VALVOLE PNEUMATICHE

Size Taglia	Code Codice	Nominal pilot pressure (bar) Pressione di pilotaggio nominale (bar)	Nominal max frequency (Hz) Frequenza max nominale (Hz)	Operating pressure range (bar) Pressione di esercizio (bar)
G 1/8"	K32P1618	3,1 bar (9 bar)	30 Hz	2,5 ÷ 9 bar
	K32P1918	3,1 bar (9 bar)	30 Hz	2,5 ÷ 9 bar
	K32P2018	0,97 bar	33 Hz	0 ÷ 9 bar
	K52P1018	3,1 bar (9 bar)	30 Hz	2,5 ÷ 9 bar
	K52DP218	(12) 1,35 bar - (14) 0,97 bar	30 Hz	0 ÷ 9 bar
	K52P2018	0,97 bar	33 Hz	0 ÷ 9 bar
	K53P2318	3 bar	10 Hz	0 ÷ 9 bar
	K53P2618	3 bar	10 Hz	0 ÷ 9 bar
	K53P2918	3 bar	10 Hz	0 ÷ 9 bar
G 1/4"	K32P1614	3,1 bar (9 bar)	30 Hz	2,5 ÷ 9 bar
	K32P1914	3,1 bar (9 bar)	30 Hz	2,5 ÷ 9 bar
	K32P2014	0,97 bar	33 Hz	0 ÷ 9 bar
	K52P1014	3,1 bar (9 bar)	30 Hz	2,5 ÷ 9 bar
	K52DP214	(12) 1,35 bar - (14) 0,97 bar	30 Hz	0 ÷ 9 bar
	K52P2014	0,97 bar	33 Hz	0 ÷ 9 bar
	K53P2314	3 bar	10 Hz	0 ÷ 9 bar
	K53P2614	3 bar	10 Hz	0 ÷ 9 bar
	K53P2914	3 bar	10 Hz	0 ÷ 9 bar

SOLENOID VALVES FEATURES / CARATTERISTICHE ELETTROVALVOLE

Size Taglia	Code Codice	Nominal max frequency (Hz) Frequenza max nominale (Hz)		Operating pressure range (bar) Pressione di esercizio (bar)	External pilot port Connessione di pilotaggio esterna	Pilot pressure Pressione di pilotaggio
		AC	DC			
G 1/8"	K32W1S618	27 Hz	17 Hz	2,5 ÷ 9 bar	-	-
	K32W1S918	27 Hz	17 Hz	2,5 ÷ 9 bar	-	-
	K32W2S018	42 Hz	34 Hz	3 ÷ 9 bar	-	-
	K52W1018	27 Hz	17 Hz	2,5 ÷ 9 bar	-	-
	K52W2018	42 Hz	34 Hz	3 ÷ 9 bar	-	-
	K52W10E8	27 Hz	17 Hz	0 ÷ 9 bar	M5	3 ÷ 9 bar
	K52W20E8	42 Hz	34 Hz	0 ÷ 9 bar	M5	3 ÷ 9 bar
	K53W2S318	12 Hz	10 Hz	3 ÷ 9 bar	-	-
	K53W2S618	12 Hz	10 Hz	3 ÷ 9 bar	-	-
K53W2S918	12 Hz	10 Hz	3 ÷ 9 bar	-	-	
G 1/4"	K32W1S614	27 Hz	17 Hz	2,5 ÷ 9 bar	-	-
	K32W1S914	27 Hz	17 Hz	2,5 ÷ 9 bar	-	-
	K32W2S014	42 Hz	34 Hz	3 ÷ 9 bar	-	-
	K52W1014	27 Hz	17 Hz	2,5 ÷ 9 bar	-	-
	K52W2014	42 Hz	34 Hz	3 ÷ 9 bar	-	-
	K52W10E4	27 Hz	17 Hz	0 ÷ 9 bar	M5	3 ÷ 9 bar
	K52W20E4	42 Hz	34 Hz	0 ÷ 9 bar	M5	3 ÷ 9 bar
	K53W2S314	12 Hz	10 Hz	3 ÷ 9 bar	-	-
	K53W2S614	12 Hz	10 Hz	3 ÷ 9 bar	-	-
K53W2S914	12 Hz	10 Hz	3 ÷ 9 bar	-	-	

For electrical features solenoid pilot see p. B-44 for G1/8 and pp. B-29 ÷ B-31 for G1/4.
Caratteristiche elettriche elettrovalvole per solenoide vedi p. B-44 per G1/8. e pp. B-29 ÷ B-31 per G1/4.

VALVE / VALVOLA 3/2

SINGLE PNEUMATIC PILOT - INTERNAL PRESSURE RETURN
 COMANDO PNEUMATICO - RIPOSIZIONAMENTO A MOLLA PNEUMATICA

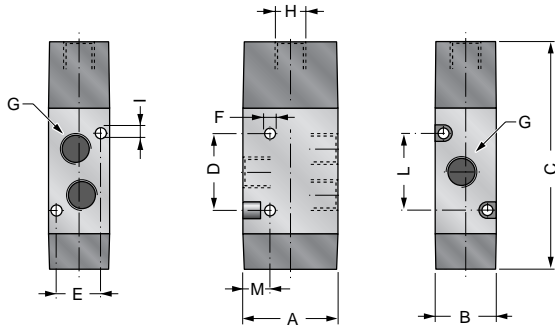
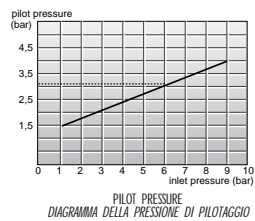
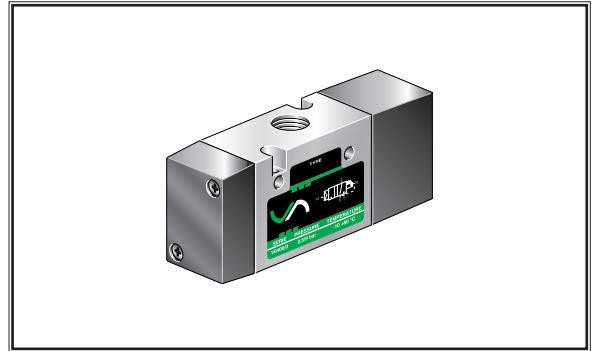

DIAGRAM / DIAGRAMMA



Size Taglia	A	B	C	D	E	ØF	G	H	ØI	L	M
1/8	28	18	66,2	22,2	13	3,2	G1/8	G1/8	3,2	22,2	8
1/4	32	22	75,3	29,3	16,2	4,2	G1/4	G1/8	3,5	29,3	7,3

K32V1P.1.



SIMBOLS / SIMBOLI

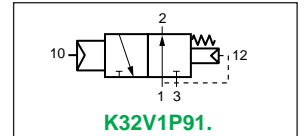
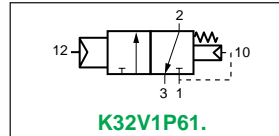

DIAGRAMS / DIAGRAMMI

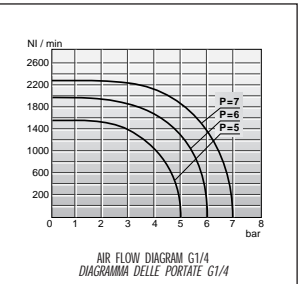
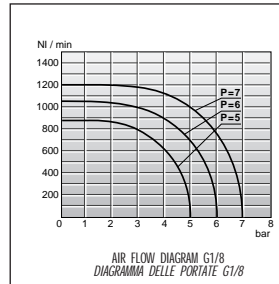

VALVE / VALVOLA 3/2

DOUBLE PNEUMATIC PILOT / *DOPIO COMANDO PNEUMATICO*

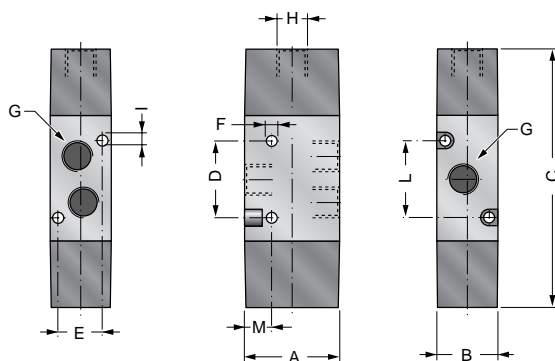
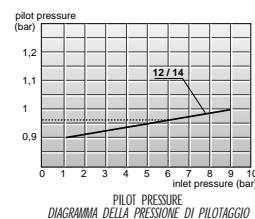
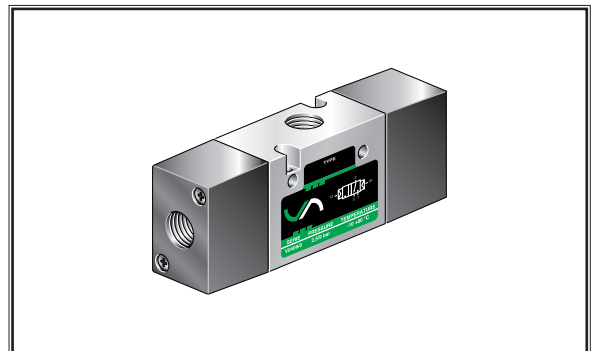

DIAGRAM / DIAGRAMMA



Size Taglia	A	B	C	D	E	ØF	G	H	ØI	L	M
1/8	28	18	76,2	22,2	13,5	3,2	G1/8	G1/8	3,2	22,2	8
1/4	32	22	88,3	29,3	16,2	4,2	G1/4	G1/8	3,5	29,3	7

K32V2P01.



SIMBOL / SIMBOLO

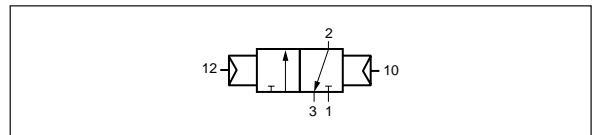

DIAGRAMS / DIAGRAMMI

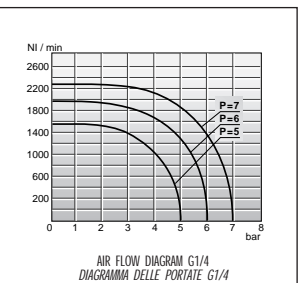
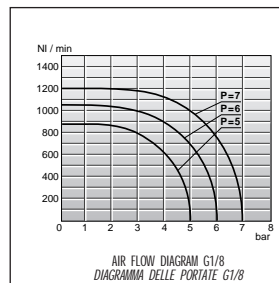

K52P101.



SIMBOLS / SIMBOLI

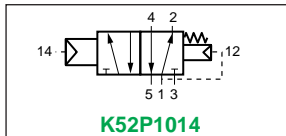
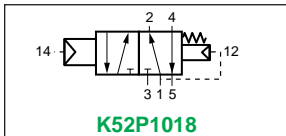

DIAGRAMS / DIAGRAMMI

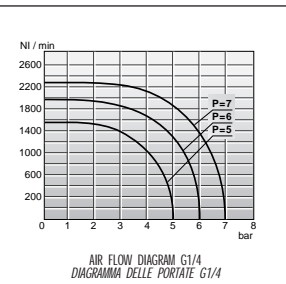
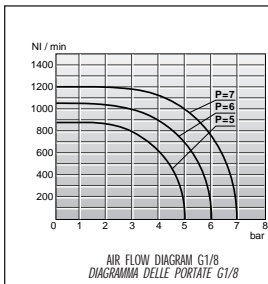

VALVE / VALVOLA 5/2

SINGLE PNEUMATIC PILOT - INTERNAL PRESSURE RETURN
COMANDO PNEUMATICO - RIPOSIZIONAMENTO A MOLLA PNEUMATICA

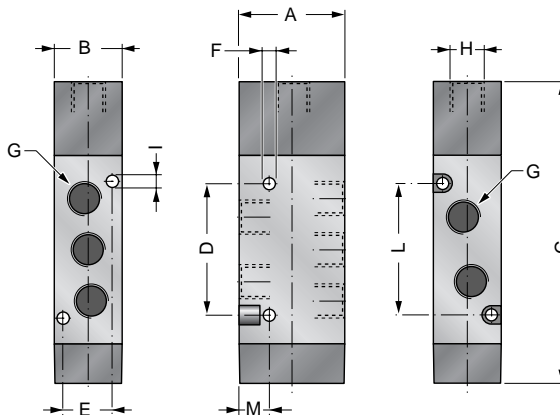
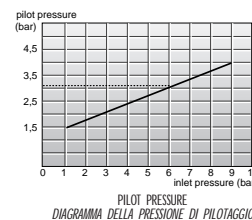

DIAGRAM / DIAGRAMMA



Size Taglia	A	B	C	D	E	ØF	G	H	ØI	L	M
1/8	28	18	80	35	13	3,2	G1/8	G1/8	3,2	35	8
1/4	32	22	96	50	16,2	4,2	G1/4	G1/8	3,5	50	7,3

K52P201.



SIMBOLS / SIMBOLI

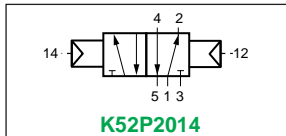
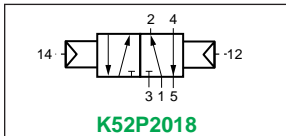

DIAGRAMS / DIAGRAMMI

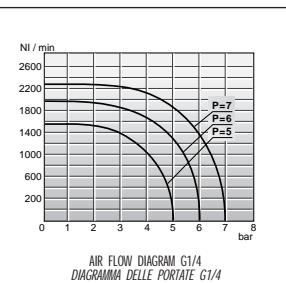
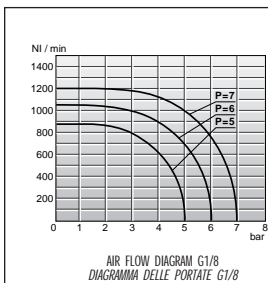

VALVE / VALVOLA 5/2

DOUBLE PNEUMATIC PILOT / DOPPIO COMANDO PNEUMATICO

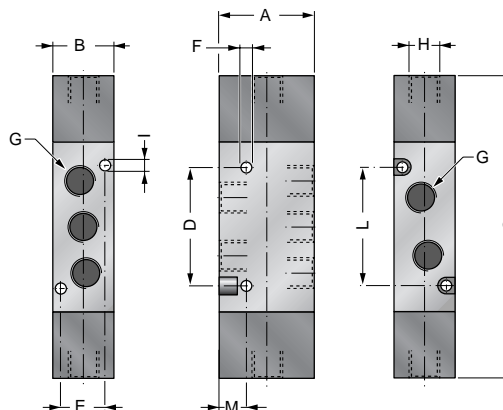
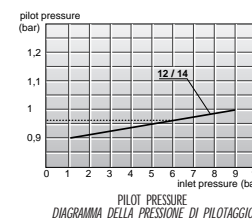

DIAGRAM / DIAGRAMMA



Size Taglia	A	B	C	D	E	ØF	G	H	ØI	L	M
1/8	28	18	89	35	13	3,2	G1/8	G1/8	3,2	35	8
1/4	32	22	109	50	16,2	4,2	G1/4	G1/8	3,5	50	7,3

VALVE / VALVOLA 5/2
 DOUBLE DIFFERENTIAL PNEUMATIC PILOT
 DOPPIO COMANDO PNEUMATICO DIFFERENZIALE

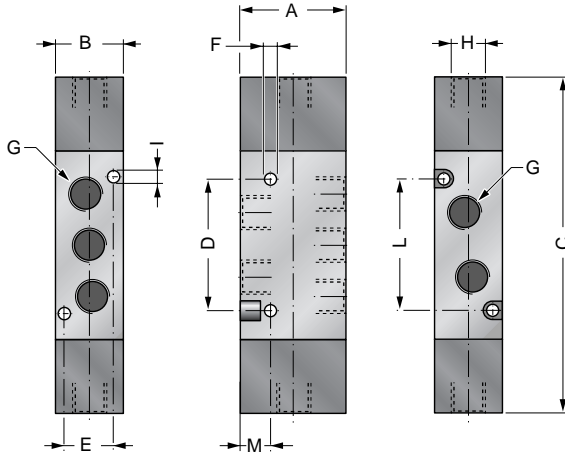
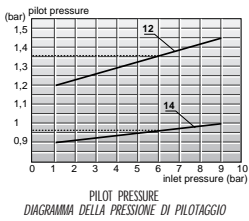
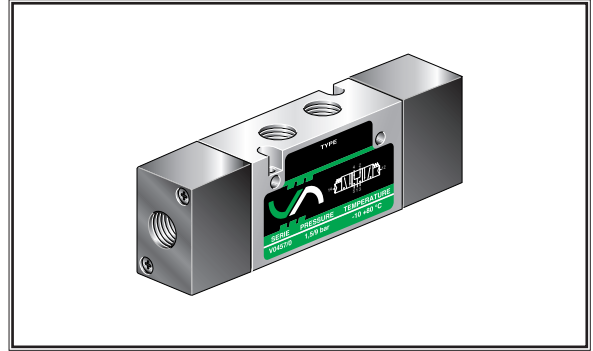

DIAGRAM / DIAGRAMMA



Size Taglia	A	B	C	D	E	ØF	G	H	ØI	L	M
1/8	28	18	89	35	13	3,2	G1/8	G1/8	3,2	35	8
1/4	32	22	109	50	16,2	4,2	G1/4	G1/8	3,5	50	7,3

K52DP21.



SIMBOLS / SIMBOLI

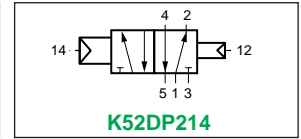
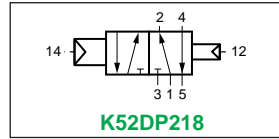

DIAGRAMS / DIAGRAMMI

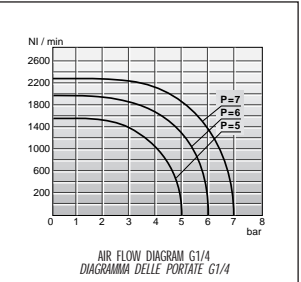
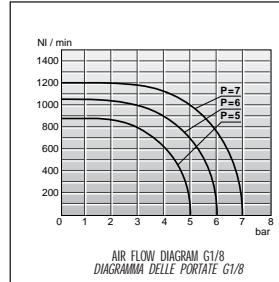

VALVE / VALVOLA 5/3

DOUBLE PNEUMATIC PILOT (MID-POSITION PRESSURIZED) / DOPPIO COMANDO PNEUMATICO (CENTRI IN PRESSIONE)
 DOUBLE PNEUMATIC PILOT (MID-POSITION CLOSED) / DOPPIO COMANDO PNEUMATICO (CENTRI CHIUSI)
 DOUBLE PNEUMATIC PILOT (MID-POSITION EXHAUSTED) / DOPPIO COMANDO PNEUMATICO (CENTRI APERTI)

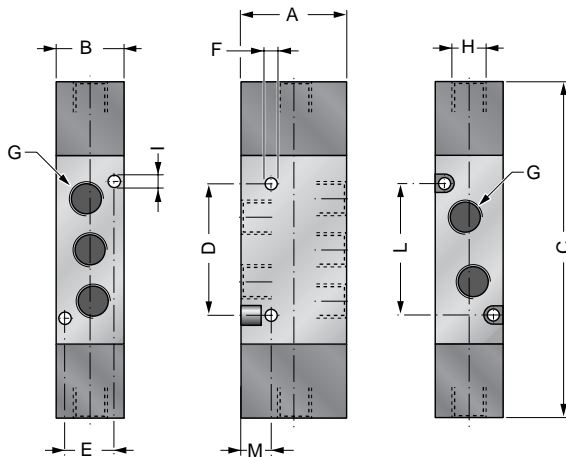
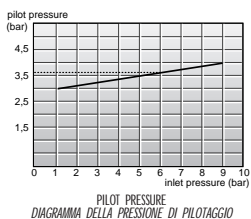
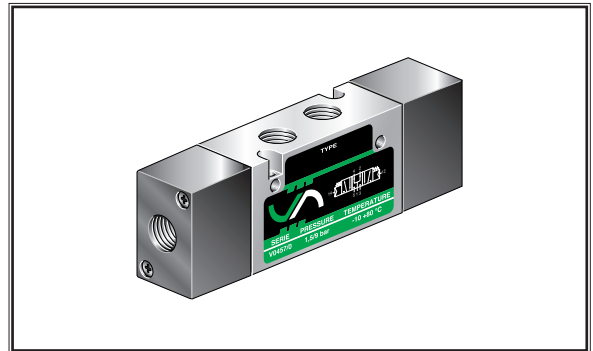

DIAGRAM / DIAGRAMMA



Size Taglia	A	B	C	D	E	ØF	G	H	ØI	L	M
1/8	28	18	89	35	13	3,2	G1/8	G1/8	3,2	35	8
1/4	32	22	109	50	16,2	4,2	G1/4	G1/8	3,5	50	7,3

K53P2.1.



SIMBOLS / SIMBOLI

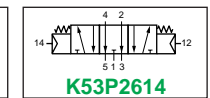
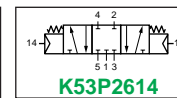
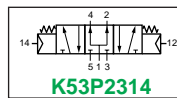
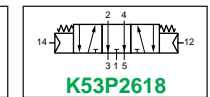
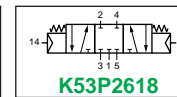
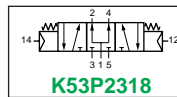

DIAGRAMS / DIAGRAMMI

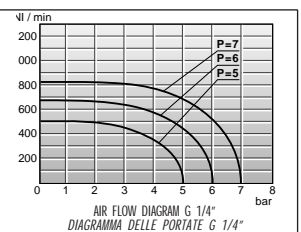
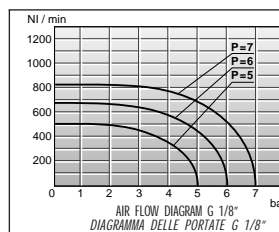

VALVOLE ED ELETTROVALVOLE

K32W1S.1.

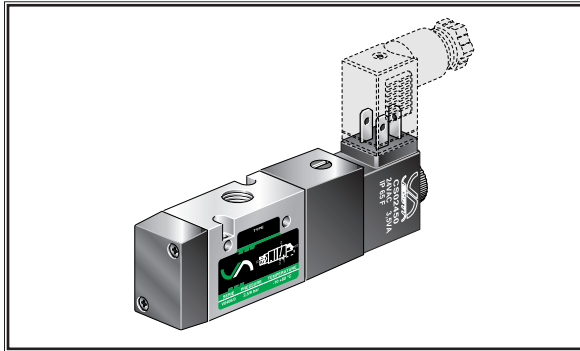

SIMBOLS / SIMBOLI

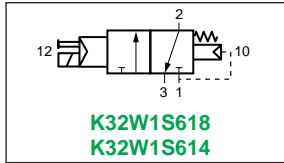
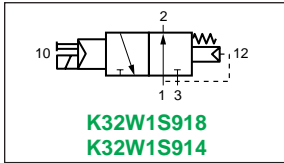

DIAGRAMS / DIAGRAMMI

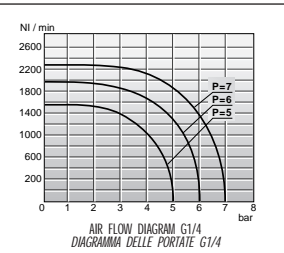
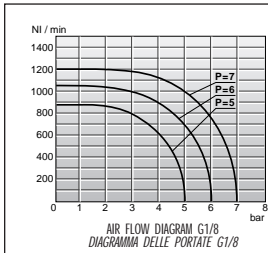

VALVE / VALVOLA 3/2

SINGLE SOLENOID PILOT - INTERNAL PRESSURE RETURN
COMANDO ELETTROPNEUMATICO - RIPOSIZIONAMENTO A MOLLA

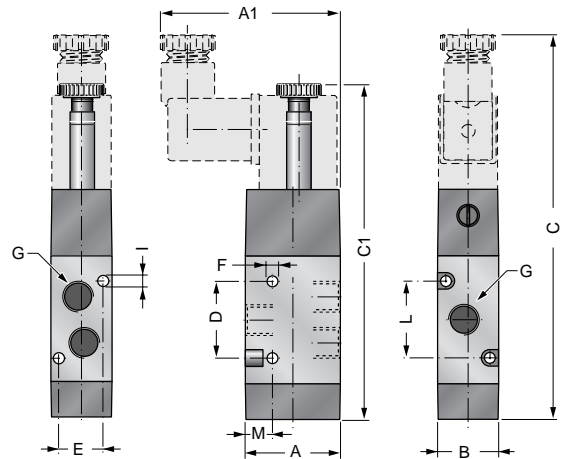

Size	A	A1	B	C	C1	D	E	ØF	G	ØI	L	M
1/8	28	-53	18	130,5	-113	22,2	13	3,2	G1/8	3,2	22,2	8
1/4	32	-55	22	121	-122	29,3	16,2	4,2	G1/4	3,5	29,3	7,3

K32W2S01.

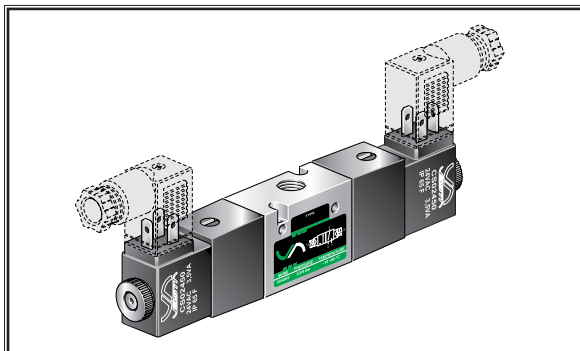

SIMBOLS / SIMBOLI

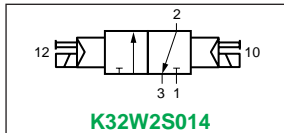
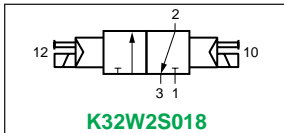

DIAGRAMS / DIAGRAMMI

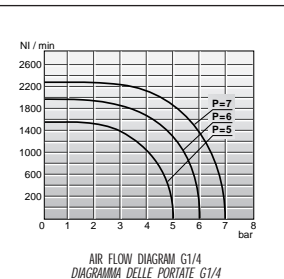
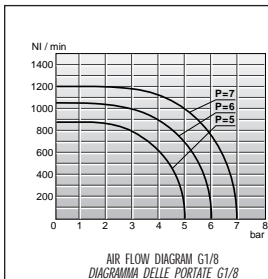

VALVE / VALVOLA 3/2

DOUBLE SOLENOID PILOT / DOPPIO COMANDO ELETTROPNEUMATICO

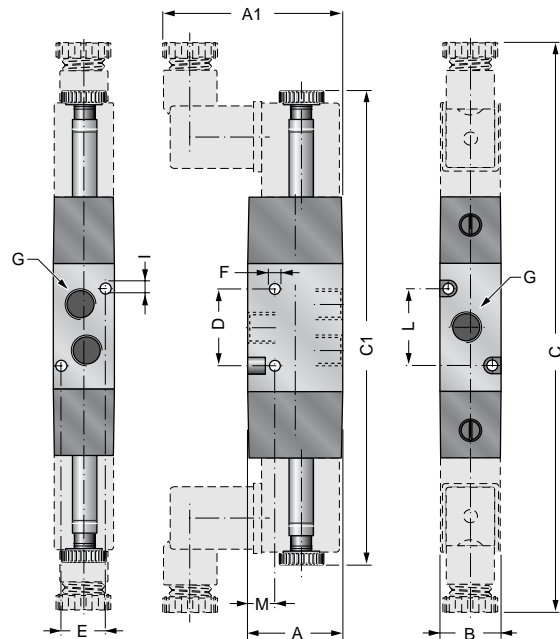

Size	A	A1	B	C	C1	D	E	ØF	G	ØI	L	M
1/8	28	-53	18	170	-143	22,2	13	3,2	G1/8	3,2	22,2	8
1/4	32	-55	22	181	-154	29,3	16,2	4,2	G1/4	3,5	29,3	7,3

VALVE / VALVOLA 5/2

SINGLE SOLENOID PILOT - INTERNAL PRESSURE RETURN
 COMANDO ELETTROPNEUMATICO - RIPOSIZIONAMENTO A MOLLA

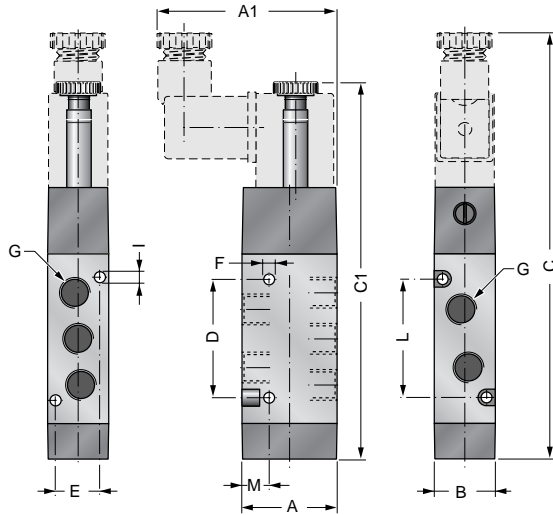

Size	Taglia	A	A1	B	C	C1	D	E	ØF	G	ØI	L	M
1/8	28	-53	18	112	-125,5	35	13	3,2	G1/8	3,2	35	8	
1/4	32	-55	22	142,5	-129	50	16,2	4,2	G1/4	3,5	50	7,3	

K52W101.

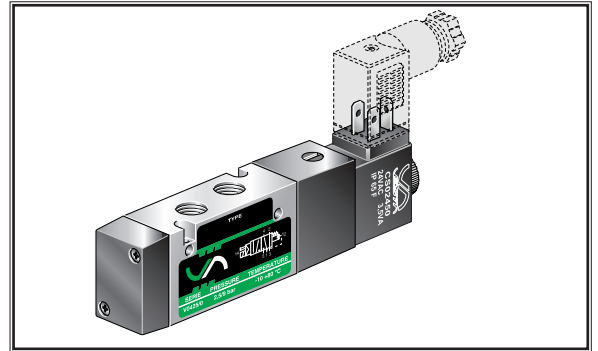

SIMBOLS / SIMBOLI

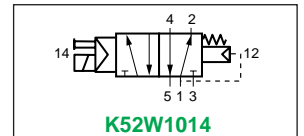
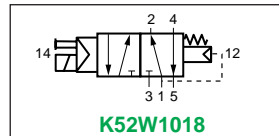

DIAGRAMS / DIAGRAMMI

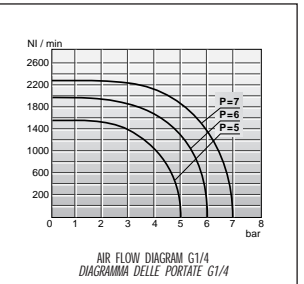
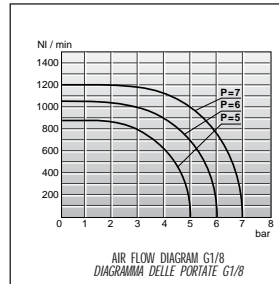

VALVE / VALVOLA 5/2

DOUBLE SOLENOID PILOT / DOPIO COMANDO ELETTROPNEUMATICO

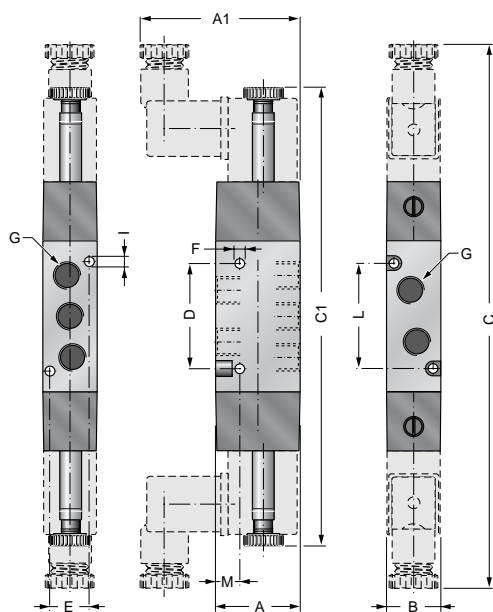

Size	Taglia	A	A1	B	C	C1	D	E	ØF	G	ØI	L	M
1/8	28	-53	18	180	-152	35	13	3,2	G1/8	3,2	35	8	
1/4	32	-55	22	202	-174	50	16,2	4,2	G1/4	3,5	50	7,3	

K52W201.

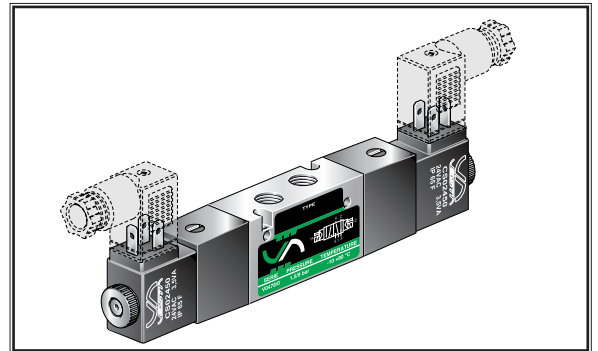

SIMBOLS / SIMBOLI

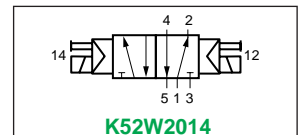
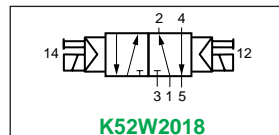

DIAGRAMS / DIAGRAMMI

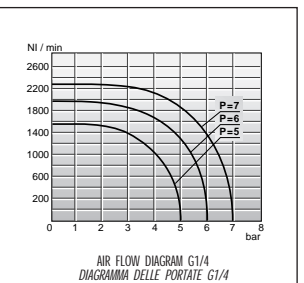
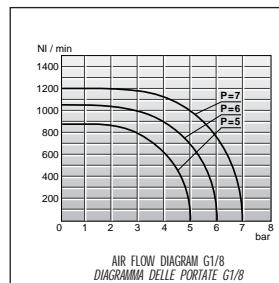

K52W10E.

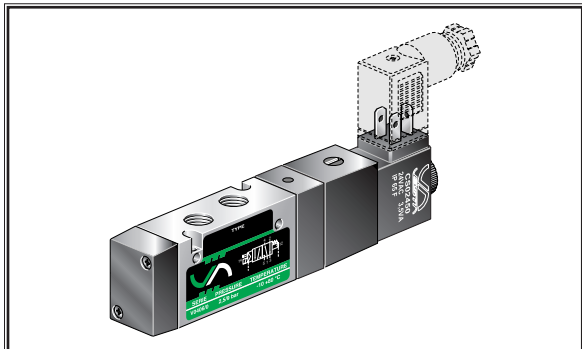

SIMBOLS / SIMBOLI

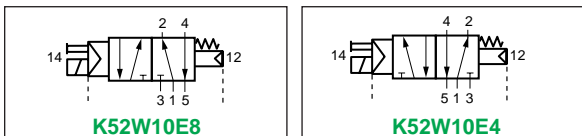

DIAGRAMS / DIAGRAMMI

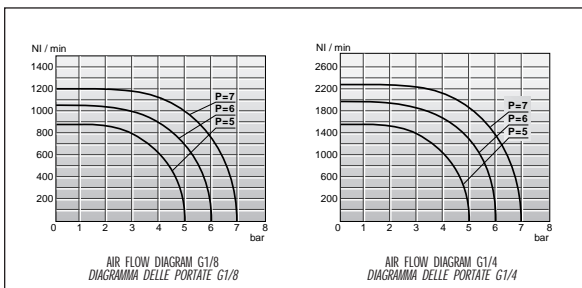

VALVE / VALVOLA 5/2

SINGLE SOLENOID PILOT - EXTERNAL PRESSURE RETURN
COMANDO ELETTROPNEUMATICO - PILOTAGGIO ESTERNO

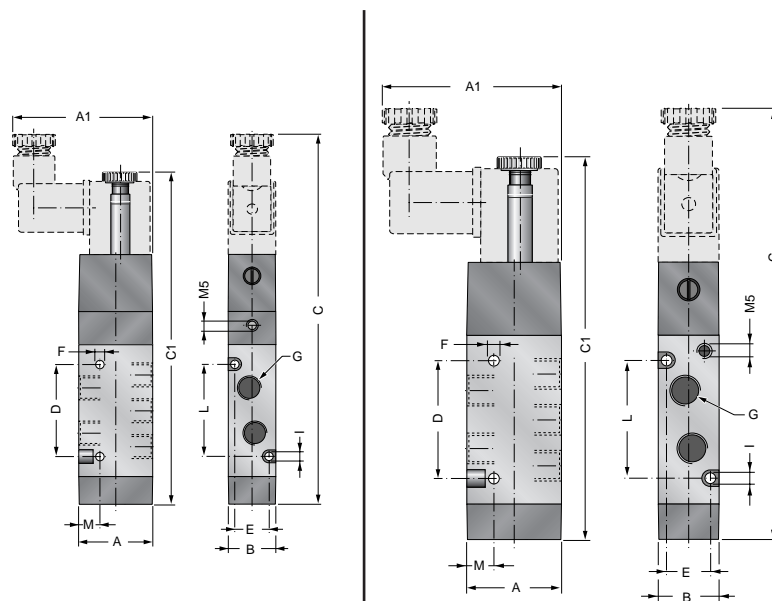

Size Taglia	A	B	C	D	E	ØF	G	ØI	L	M	A1	C1
1/8	28	18	112	35	13	3,2	G1/8	3,2	35	8	53	127
1/4	32	22	142,5	50	16,2	4,2	G1/4	3,5	50	7,3	55	129

K52W20E.

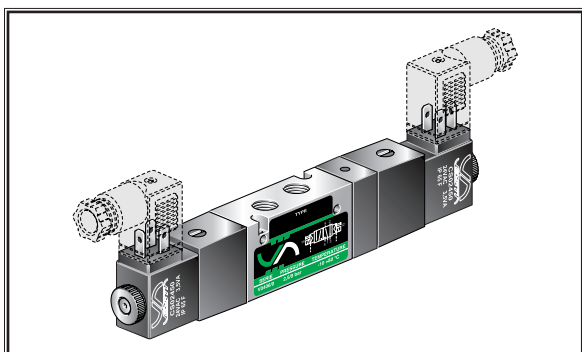

SIMBOLS / SIMBOLI

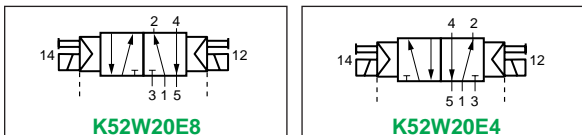

DIAGRAMS / DIAGRAMMI

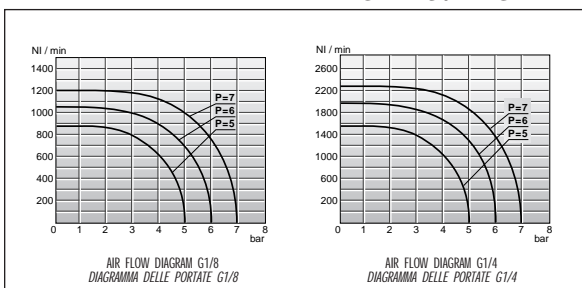

VALVE / VALVOLA 5/2

DOUBLE SOLENOID PILOT - EXTERNAL PRESSURE RETURN
DOPPIO COMANDO ELETTROPNEUMATICO - PILOTAGGIO ESTERNO

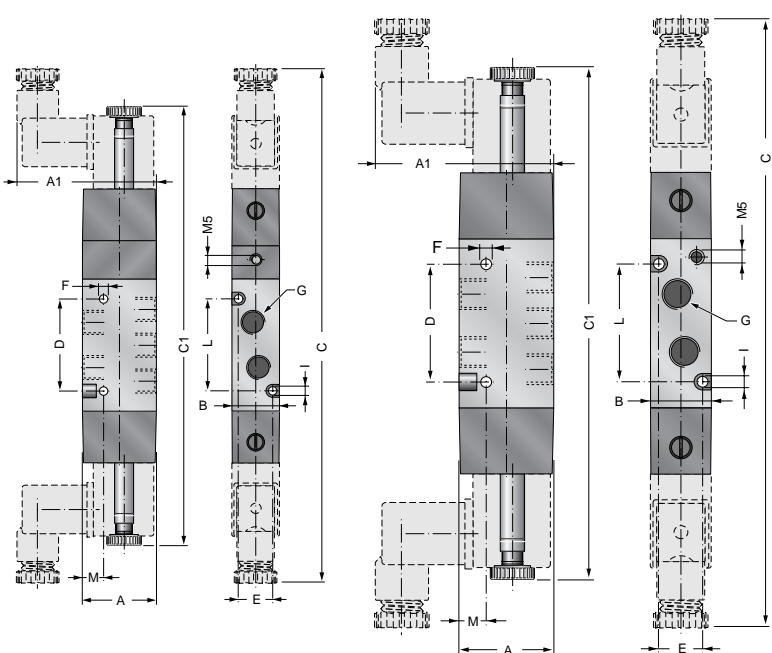

Size Taglia	A	B	C	D	E	ØF	G	ØI	L	M	A1	C1
1/8	28	18	180	35	13	3,2	G1/8	3,2	35	8	53	152
1/4	32	22	202	50	16,2	4,2	G1/4	3,5	50	7,3	55	174

VALVE / VALVOLA 5/3

DOUBLE PNEUMATIC PILOT (MID-POSITION PRESSURIZED) / **DOPIO COMANDO PNEUMATICO (CENTRI IN PRESSIONE)**
 DOUBLE PNEUMATIC PILOT (MID-POSITION CLOSED) / **DOPIO COMANDO PNEUMATICO (CENTRI CHIUSI)**
 DOUBLE PNEUMATIC PILOT (MID-POSITION EXHAUSTED) / **DOPIO COMANDO PNEUMATICO (CENTRI APERTI)**

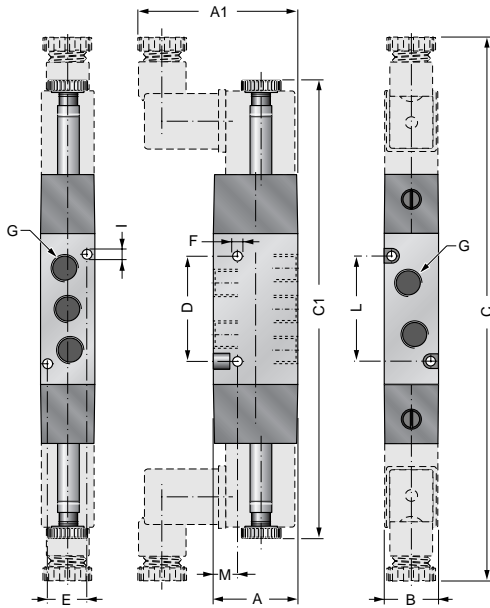

Size Taglia	A	A1	B	C	C1	D	E	ØF	G	ØI	L	M
1/8	28	-53	18	180	-152	35	13	3,2	G1/8	3,2	35	8
1/4	32	-55	22	202	-174	50	16,2	4,2	G1/4	3,5	50	7,3

K53W2S . 1.

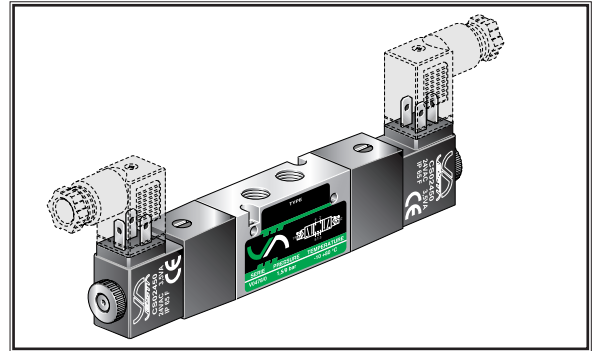

SIMBOLS / SIMBOLI

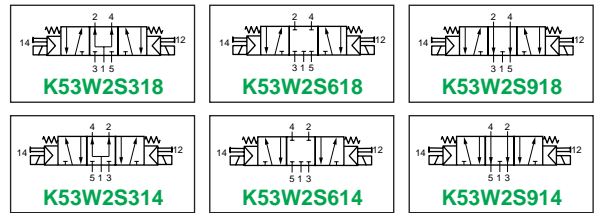

DIAGRAMS / DIAGRAMMI

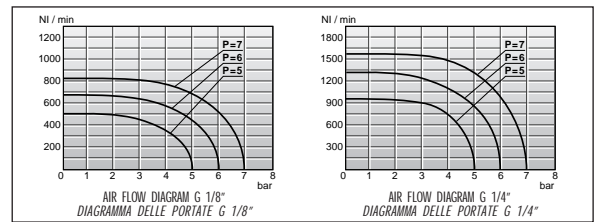

MANIFOLD / BASE A DOPPIO INGRESSO **KME ...**

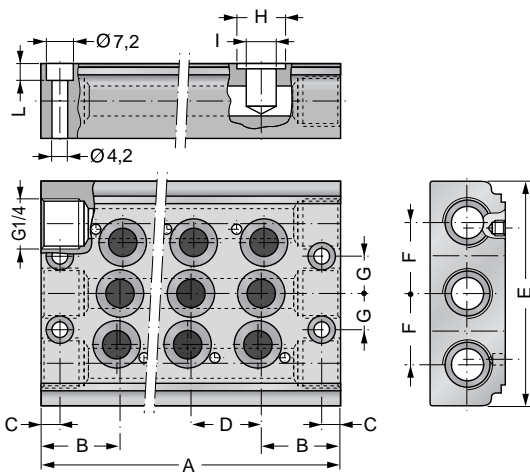

Size Taglia	B	C	D	E	F	G	ØH	ØI	L
1/8	21	5	19	60	19	10	13	8	4,5
1/4	25	6,5	23	70	23	11,5	15,9	10	5

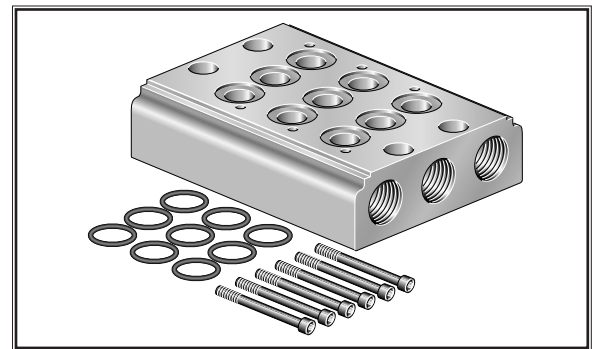

CODES / CODICI

Code Codice	A	Place Posti
KME218	61	2
KME318	80	3
KME418	99	4
KME518	118	5
KME618	137	6
KME718	156	7
KME818	175	8
KME918	194	9
KME1018	213	10
KME214	73	2
KME314	96	3
KME414	119	4
KME514	142	5
KME614	165	6
KME714	188	7
KME814	211	8
KME914	234	9
KME1014	257	10

- Available upon request manifold up to 20 places.
- Valves fixing screws and seals are supplied with manifold.
- Subbase fixing screws not supplied.
- Manifold supplied assembled on demand.
- A richiesta sono fornibili basi sino a 20 posti
- Le viti e le guarnizioni per il fissaggio delle valvole vengono fornite con la base.
- Il fissaggio alla base è a cura del cliente.
- A richiesta, la base può essere fornita preassemblata.



COILS FOR SOLENOID VALVES AND ACCESSORIES SOLENOIDI PER ELETTROVALVOLE ED ACCESSORI

KPCH01. PLUG FLAT / CHIUSURA POSTO INUTILIZZATO

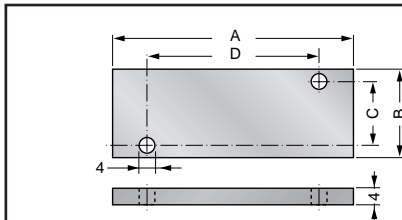
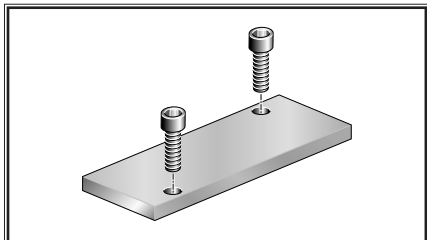

Plug flat includes assembling screws.

La piastrina di chiusura dei posti non utilizzati della base é fornita con le relative viti di fissaggio.

Size Taglia	A	B	C	D	Code Codice
1/8	49	18	13	35,5	KPCH018
1/4	60	22	16,2	50	KPCH014

CS..... COILS / SOLENOIDI PER ELETTROVALVOLE

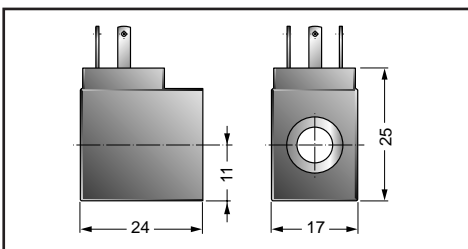
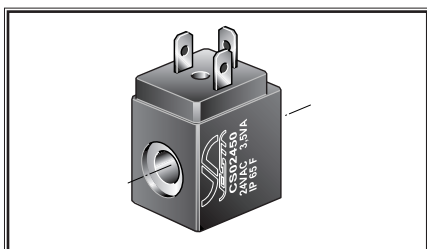

CODES / CODICI

Code ordination Codice ordinazione	Voltage Tensione
CS01200	12 V DC
CS02400	24 V DC
CS02450	24 V 50/60Hz AC
CS11050 (*)	110 V 50/60Hz AC
CS22050 (*)	220 V 50/60Hz AC

(*) Please see page / Vedi pag. B-31

TECHNICAL FEATURES

Standard tensions	12, 24, V DC 24, 110, 220 V AC (50/60 Hz)
Other tensions	Contact our commercial department
Duty cycle	100% (continuous)
Power at 20 °C	2,4 Watt DC; 3,5 VA AC
Nominal tension	± 10% during normal working
Operating temperature range	-20 °C ÷ +50 °C
Degree of protection	Fixed plug IP 65 (IEC 144) with connector
Insulation	Class F
Materials	Wire class H - coil moulding glass filled nylon

CARATTERISTICHE TECNICHE

Tensioni standard	12, 24, V DC 24, 110, 220 V AC (50/60 Hz)
Altre tensioni	Interpellare il ns. servizio tecnico commerciale
Funzionamento	100% ED alla potenza ed alla temperatura ambiente indicata
Potenza assorbita a 20 °C	2,4 Watt in DC; 3,5 VA in AC
Tensione nominale	± 10% a bobina calda
Limiti di temperatura ambiente	-20 °C ÷ +50 °C
Protezione	IP 65 secondo IEC 144 con connettore
Bobina	Bobina completa classe F
Materiali	Rivestimento nylon caricato vetro filo di rame classe H

CEP/0..... SOLENOID CONNECTORS / CONNETTORI

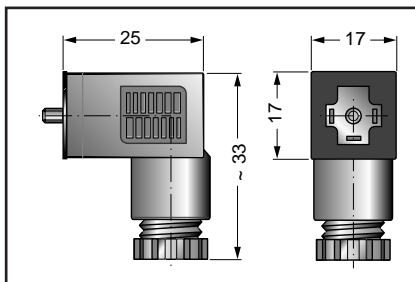
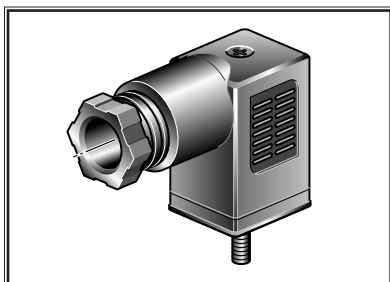

CODES / CODICI

Description Descrizione	Code Codice	Voltage Tensione
Universal connector Connettore universale	CEP/0	All tension Tutte le tensioni
Connector with led Connettore con led	CEP/0 L 10/50 CEP/0 L 70/250	10/50 V AC / DC 70/250 V AC / DC
Connector with led and varistor Connettore con led e varistore	CEP/0 LV 24 CEP/0 LV 110 CEP/0 LV 220	24 V AC / DC 110 V AC / DC 220 V AC / DC

TECHNICAL FEATURES

Wire connection	With screwed terminals
Gland thread	PG 7
Number of poles	2 Poles + earth
Housing colour	Black, transparent in the led version.

CARATTERISTICHE TECNICHE

Connessione cavi	Con morsetti a vite
Filettatura passacavo	PG 7
N° Poli	2 Poli + terra
Colori connettore	Nero, trasparente nelle versioni con led.